

# SU968

ULT

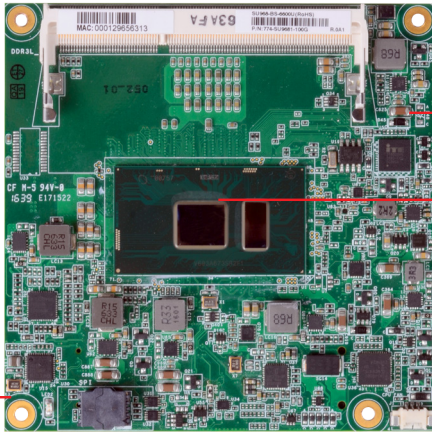

DDR3L SODIMM  
Intel® Celeron®/Core™ i7/i5/i3

CPU Fan

## Features

- Dual channel DDR3L 1600MHz SODIMM up to 16GB
- Three independent displays: VGA\*/DDI + LVDS\*/eDP + DDI
- DP++ supports 4K x 2K resolution
- Multiple expansion: 8 PCIe x1, 1 LPC, 1 I<sup>2</sup>C, 1 SMBus
- Rich I/O: 1 Intel GbE, 4 USB 3.0, 8 USB 2.0

\* Populated by default



## Mechanical Drawing

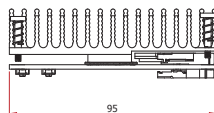
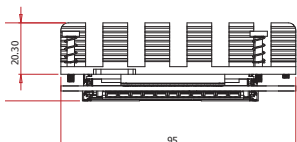
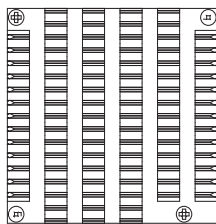
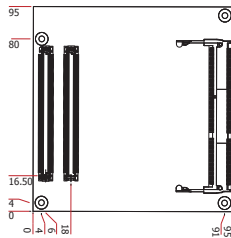
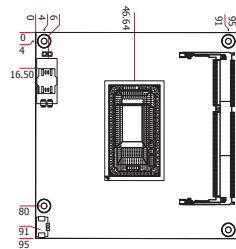

## Block Diagram

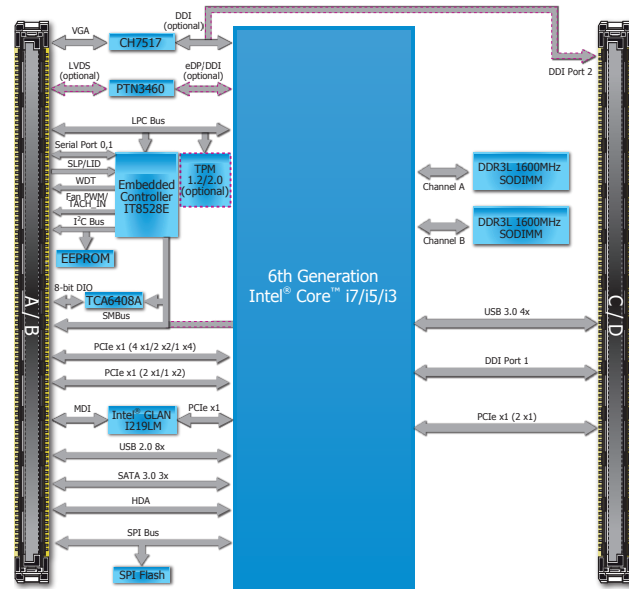

PCIe L0~3		PCIe L4~5		PCIe L6~7	
x4		-		-	
x2		x2		-	
x1	x1	x1	x1	x1	x1

\* 5 PCIe x1 or 4 PCIe x1 + 1 PCIe x4 or 3 PCIe x1 + 2 PCIe x2 (support up to 5 devices and 8 lanes)

## Specifications

<b>SYSTEM</b>	<b>Processor</b>	6th Generation Intel® Core™ Processors, BGA 1356 Intel® Core™ i7-6600U Processor, Dual Core, 4M Cache, 2.6GHz (3.4GHz), 15W Intel® Core™ i5-6300U Processor, Dual Core, 3M Cache, 2.4GHz (3.0GHz), 15W Intel® Core™ i3-6100U Processor, Dual Core, 3M Cache, 2.3GHz, 15W Intel® Celeron® Processor 3955U, Dual Core, 2M Cache, 2.0GHz, 15W	
	<b>Memory</b>	Two 204-pin SODIMM up to 16GB	Dual Channel DDR3L 1600MHz
	<b>BIOS</b>	Insyde SPI 128Mbit	
<b>GRAPHICS</b>	<b>Controller</b>	Intel® HD Graphics	
	<b>Feature</b>	OpenGL 5.0, DirectX 12, OpenCL 2.1 HW Decode: AVC/H.264, MPEG2, VC1/WMV9, JPEG/MJPEG, HEVC/H265, VP8, VP9 HW Encode: AVC/H.264, MPEG2, JPEG, HEVC/H265, VP8, VP9	
	<b>Display</b>	1 x VGA/DDI (DDI available upon request) 1 x LVDS/eDP (eDP available upon request) 1 x DDI	VGA: resolution up to 2560x1600 @ 60Hz LVDS: dual channel 24-bit, resolution up to 1920x1200 @ 60Hz HDMI: resolution up to 4096x2160 @ 24Hz or 2560x1600 @ 60Hz DP++: resolution up to 4096x2304 @ 60Hz
	<b>Triple Displays</b>	VGA + LVDS + DDI	DDI + eDP + DDI
<b>EXPANSION</b>	<b>Interface</b>	5 PCIe x1 or 4 PCIe x1 + 1 PCIe x4 or 3 PCIe x1 + 2 PCIe x2 (support up to 5 devices and 8 lanes) 1 x LPC 1 x I <sup>2</sup> C 1 x SMBus 2 x UART (TX/RX)	
<b>AUDIO</b>	<b>Interface</b>	HD Audio	
<b>ETHERNET</b>	<b>Controller</b>	1 x Intel® I219LM with iAMT11.0 PCIe (10/100/1000Mbps) (only Core i7/i5 supports iAMT)	
<b>I/O</b>	<b>USB</b>	4 x USB 3.0 8 x USB 2.0	
	<b>SATA</b>	3 x SATA 3.0 (up to 6Gb/s) RAID 0/1/5/10	
	<b>DIO</b>	1 x 8-bit DIO	
	<b>WATCHDOG TIMER</b>	<b>Output &amp; Interval</b>	System Reset, Programmable via Software from 1 to 255 Seconds
<b>SECURITY</b>	<b>TPM</b>	Available Upon Request	
<b>POWER</b>	<b>Type</b>	12V, 5VSB, VCC_RTC (ATX mode)	12V, VCC_RTC (AT mode)
	<b>Consumption</b>	Typical: I7-6600U: 12V @ 0.86A (10.28Watt) Max.: I7-6600U: 12V @ 1.372A (16.46Watt)	
<b>OS SUPPORT</b>		Windows 7 (/WES7) 32/64-bit Windows 8.1 (64-bit) Windows 10 IoT Enterprise 64-bit	Debian 8 (with VESA graphic driver) CentOS 7 (with VESA graphic driver) Ubuntu 15.10 (Intel graphic driver available)
<b>ENVIRONMENT</b>	<b>Temperature</b>	Operating: 0 to 60°C -40 to 85°C (with heat spreader)	Storage: -40 to 85°C
	<b>Humidity</b>	Operating: 5 to 90% RH	Storage: 5 to 90% RH
	<b>MTBF</b>	921,923 hrs @ 25°C; 460,715 hrs @ 45°C; 256,677 hrs @ 60°C Calculation Model: Telcordia Issue 2, Method Case 3 Environment: GB, GC – Ground Benign, Controlled	
<b>MECHANICAL</b>	<b>Dimensions</b>	COM Express® Compact	95mm (3.74") x 95mm (3.74")
	<b>Compliance</b>	PICMG COM Express® R2.1, Type 6	

## Ordering Information

Model Name	P/N	Processor	Memory	VGA/DDI	LVDS/eDP	GbE	USB 3.0	USB 2.0	SATA	Power	Thermal	Temp.
<b>SU968-BS-6600U</b>	770-SU9681-100G	i7-6600U	2 SODIMM	VGA	LVDS	1	4	8	3	ATX/AT	Fanless	0 to 60°C
<b>SU968-BS-6300U</b>	770-SU9681-400G	i5-6300U	2 SODIMM	VGA	LVDS	1	4	8	3	ATX/AT	Fanless	0 to 60°C
<b>SU968-BS-3955U</b>	770-SU9681-500G	3955U	2 SODIMM	VGA	LVDS	1	4	8	3	ATX/AT	Fanless	0 to 60°C

Note: i3-6100U is supported upon request with MOQ requirement.

## Packing List

• 1 SU968 board	
• 1 DVD	
• 1 Heat sink (Height: 23.8mm)	A71-011060-000G

## Optional Items

• COM332-B carrier board kit	770-CM3321-000G
• Heat spreader (Height: 11mm)	A71-011070-000G