



3rd/2nd Gen Intel® Core™  
Desktop Box PC

# DT122-CR

QM77



## ► Features

- Supports DDR3/DDR3L SODIMM up to 16GB
- Up to 2x 2.5" or 1x 3.5" SATA drive bay
- 1 HDMI, 2 DVI-I, 4 USB 3.0, 2 USB 2.0, 2 LAN, 1 COM
- 3 independent displays



Optional  
Optical Drive



## ► Panel

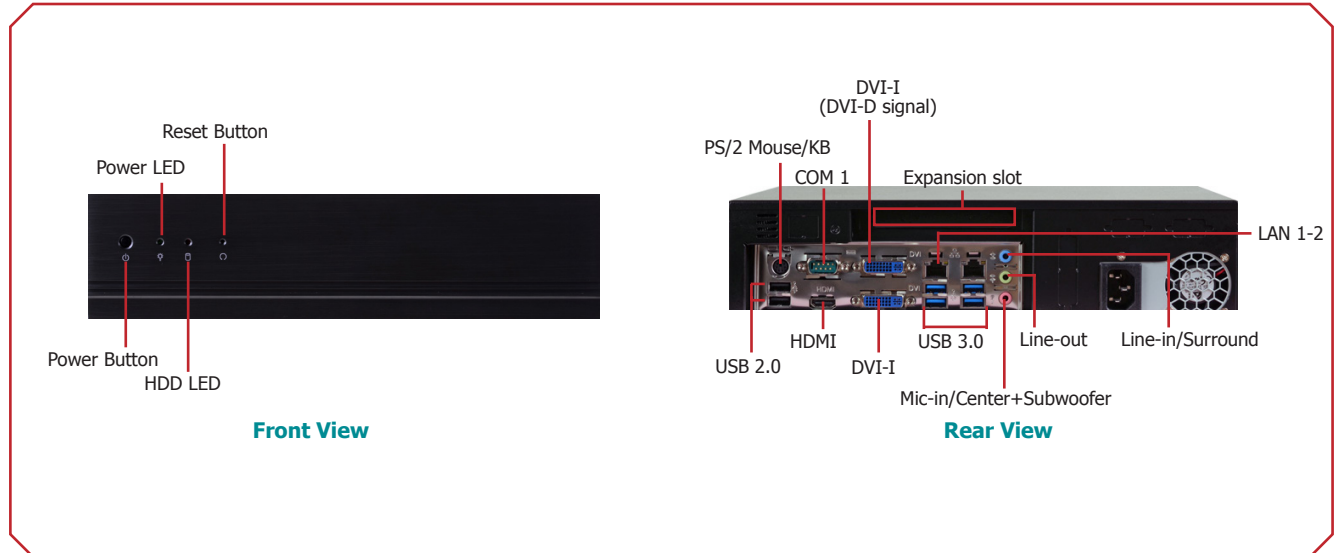

## ► Dimensions

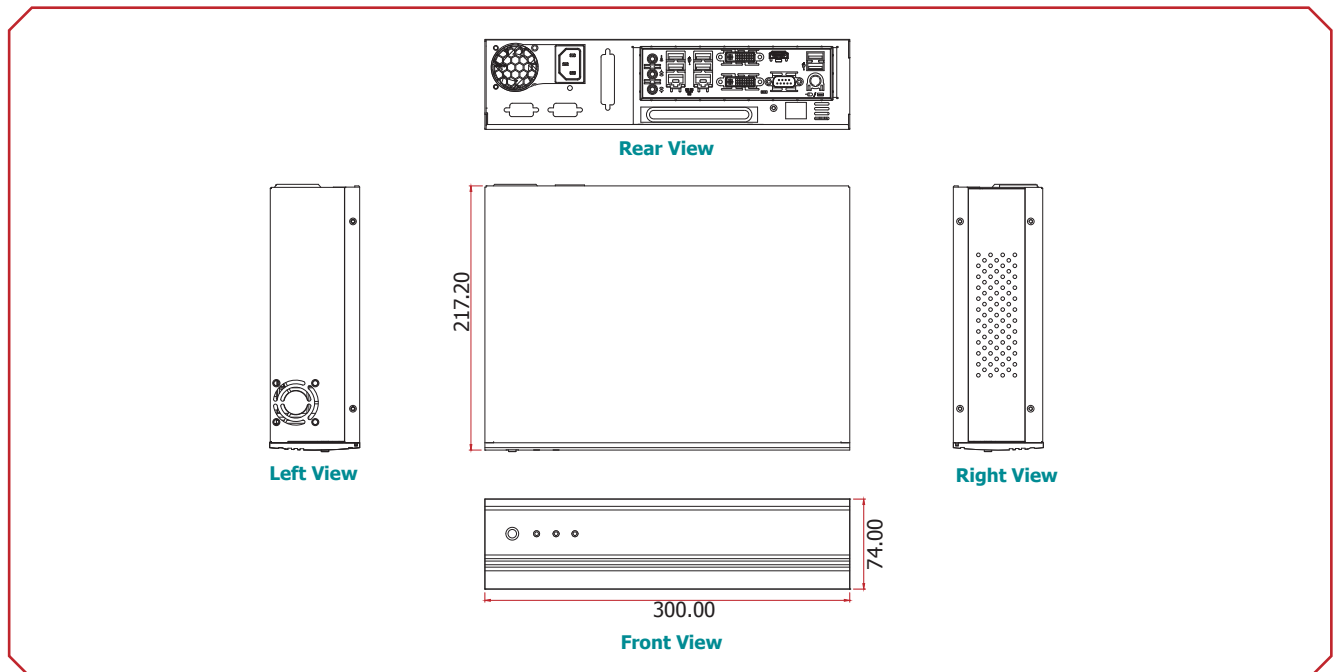

# DT122-CR

## ► Specifications

### PROCESSOR SYSTEM

- Processors:
  - 3rd Generation Intel® Core™ processors (22nm process technology)
    - Intel® Core™ i7-3610QE (6M Cache, up to 3.3 GHz); 45W
    - Intel® Core™ i5-3610ME (3M Cache, up to 3.3 GHz); 35W
    - Intel® Core™ i3-3120ME (3M Cache, 2.4 GHz); 35W
  - 2nd Generation Intel® Core™ processors (32nm process technology)
    - Intel® Core™ i7-2710QE (6M Cache, up to 3.0 GHz); 45W
    - Intel® Core™ i5-2510E (3M Cache, up to 3.1 GHz); 35W
    - Intel® Core™ i3-2330E (3M Cache, 2.2 GHz); 35W
    - Intel® Celeron® B810 (2M Cache, 1.6 GHz); 35W
- Chipset: Intel® QM77 Express chipset

### MEMORY

- 2 DDR3/DDR3L 1066/1333/1600MHz SODIMM
- Supports up to 16GB memory

### GRAPHICS

- Intel® HD Graphics 4000
- Display ports: HDMI, 2 DVI-I (1 supports DVI-D signal)
- HDMI and DVI display resolution up to 1920x1200
- VGA display resolution up to 2048x1536 pixels with 32-bit color at 75Hz

### STORAGE

- Up to 2 2.5" or 1 3.5" SATA drive bay
- 1 optical drive bay (optional)

### ETHERNET

- Intel® WG82579LM with iAMT8.0 Gigabit Ethernet Phy
- Intel® WG82574L PCI Express Gigabit Ethernet controller

### AUDIO

- Realtek® ALC886 5.1-channel High Definition Audio

### COM

- 1 DB-9 RS232/422/485 COM port
- 2 DB-9 RS232 and/or RS232/422/485 COM ports (optional)

### USB

- 4 Type A USB 3.0/1.1 ports
- 2 Type A USB 2.0/1.1 ports
- 2 Type A USB 2.0/1.1 ports (optional)

### I/O PORTS

- Front Panel
  - 1 Power button
  - 1 Reset button
  - 2 LED indicators: Power, HDD
- Rear Panel
  - 1 mini-DIN-6 for PS/2 mouse/keyboard
  - 4 USB 3.0/2.0/1.1
  - 2 USB 2.0/1.1
  - 1 DB-9 RS232/422/485 COM
  - 1 HDMI
  - 2 DVI-I (1 supports DVI-D signal only)
  - 2 RJ45 LAN
  - Line-in/surround, Line out, and Mic-in/Center+Subwoofer jacks

### EXPANSION

- 1 expansion slot
  - 1 PCIe x16 or PCI slot
- 1 Mini PCIe slot (PCIe and USB signals)
  - Supports half size Mini PCIe card

### POWER

- Power type
  - ATX
- Power input voltage
  - AC 100-240V, 3.5A, 150W

### COOLING SYSTEM

- 1 CPU cooler

### ENVIRONMENT

- Temperature
  - Operating: 0°C ~ 45°C
  - Storage: -20°C ~ 60°C
- Humidity
  - 90% RH at 45°C, 1 week

### VIBRATION

- Operating: 1G, 5~500Hz
- Non-operating: 1.5G, 5~25Hz
- IEC 68-2-64 compliant

### SHOCK

- Operating: 3G peak acceleration (11 msec. duration)
- Non-operating: 10G peak acceleration (11 msec. duration)
- IEC 68-2-27 compliant

### CONSTRUCTION

- Front panel: aluminum
- Rear chassis: sheet metal

### MOUNTING

- 2 types of wall mount bracket
  - Type A
  - Type B

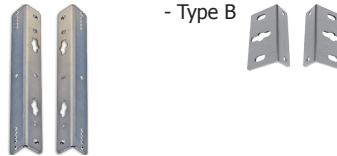

- Brackets and screws (optional)

### DIMENSIONS

- 300mm x 75mm x 217mm (W x H x D)

### WEIGHT

- 3.71 kg

### OS SUPPORT

- Windows 7, Windows 7 Embedded, Windows XP, Windows XP Embedded, Linux Kernel 2.6

### CERTIFICATION

- CE
- FCC Class B
- RoHS



# DT122-CR

## ▶ Wall Mounting

### Type A Wall mount bracket

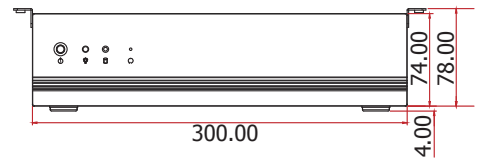
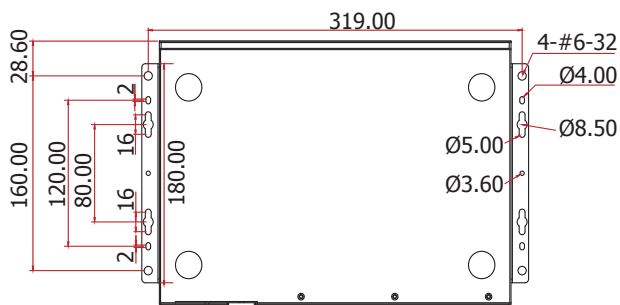
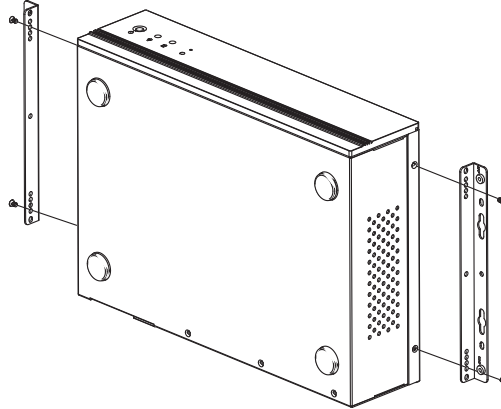

### Type B Wall mount bracket

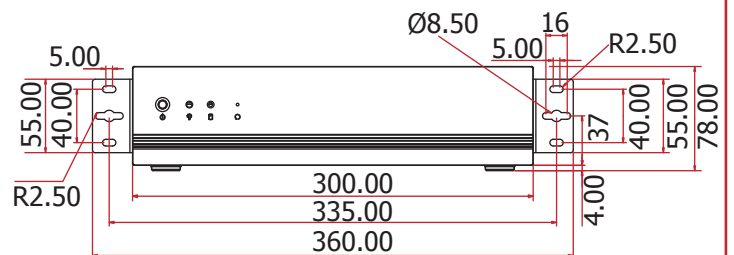
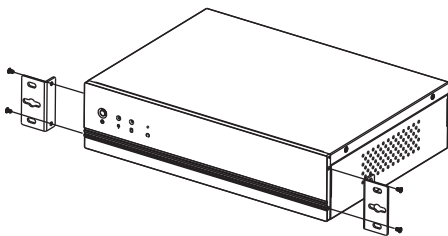

## DT122-CR

## ► Ordering Information

Model Name	Part Number	Description
DT122-CR	750-DT1220-200G	DT122-CR: CR100 RoHS
	750-DT1220-700G	DT122-CR: W/DVD CR100 RoHS
	750-DT1220-220G	DT122-CR: CR100, RoHS, with 1 PCI expansion
	750-DT1220-210G	DT122-CR: CR100, RoHS, with 1 PCIe x16 expansion

## ► Optional Items

Optional Items	Part Number	Description
<b>CPU</b>	785-CP988BML	CPU, Socket 988B, Long-term support, RoHS
<b>Memory</b>	785-RSOD38G-L	SODIMM, DDR3L Module (supports dual voltage 1.5V DDR3/1.35V DDR3L), 8GB, RoHS
	785-RSOD34G-L	SODIMM, DDR3L Module (supports dual voltage 1.5V DDR3/1.35V DDR3L), 4GB, RoHS
	785-RSOD32G-L	SODIMM, DDR3L Module (supports dual voltage 1.5V DDR3/1.35V DDR3L), 2GB, RoHS
	785-RSOD31G	SODIMM, DDR3 Module, 1GB, RoHS
<b>HDD</b>	785-H353T0B	3.5" SATA HDD, 500GB, RoHS
	785-H25500G	2.5" SATA HDD, 500GB, RoHS
	785-H25320G	2.5" SATA HDD, 320GB, RoHS
	785-S251TBG	2.5" SATA SSD, 1TB MLC, RoHS
	785-S25512G	2.5" SATA SSD, 512GB MLC, RoHS
	785-S25256G	2.5" SATA SSD, 256GB MLC, RoHS
	785-S25128G	2.5" SATA SSD, 128GB MLC, RoHS
	785-S25064G	2.5" SATA SSD, 64GB MLC, RoHS
<b>Wi-Fi</b>	761-110091-000G	Wi-Fi Kit, RoHS
<b>Power Cord</b>	785-PWRD	Power Cord, Standards (USA/EUR/CH), 1.8m, RoHS
<b>Wall Mount</b>	761-DT1220-100G	DT122 Type A Wall Mount Kit for Top Cover, RoHS
	761-DT1220-000G	DT122 Type B Wall Mount Kit for Front Cover, RoHS

## ► Packing List

• 1 DT122 system unit
• 1 CPU cooler
• 1 HDD drive bay kit
• 1 Quick Installation Guide
• 1 CD disk includes:
- Drivers / Manual