



DT122-HR
Desktop Box IPC
User's Manual

Copyright

This publication contains information that is protected by copyright. No part of it may be reproduced in any form or by any means or used to make any transformation/adaptation without the prior written permission from the copyright holders.

This publication is provided for informational purposes only. The manufacturer makes no representations or warranties with respect to the contents or use of this manual and specifically disclaims any express or implied warranties of merchantability or fitness for any particular purpose. The user will assume the entire risk of the use or the results of the use of this document. Further, the manufacturer reserves the right to revise this publication and make changes to its contents at any time, without obligation to notify any person or entity of such revisions or changes.

Changes after the publication's first release will be based on the product's revision. The website will always provide the most updated information.

© 2013. All Rights Reserved.

Trademarks

Product names or trademarks appearing in this manual are for identification purpose only and are the properties of the respective owners.

FCC and DOC Statement on Class B

This equipment has been tested and found to comply with the limits for a Class B digital device, pursuant to Part 15 of the FCC rules. These limits are designed to provide reasonable protection against harmful interference when the equipment is operated in a residential installation. This equipment generates, uses and can radiate radio frequency energy and, if not installed and used in accordance with the instruction manual, may cause harmful interference to radio communications. However, there is no guarantee that interference will not occur in a particular installation. If this equipment does cause harmful interference to radio or television reception, which can be determined by turning the equipment off and on, the user is encouraged to try to correct the interference by one or more of the following measures:

- Reorient or relocate the receiving antenna.
- Increase the separation between the equipment and the receiver.
- Connect the equipment into an outlet on a circuit different from that to which the receiver is connected.
- Consult the dealer or an experienced radio TV technician for help.

Notice:

1. The changes or modifications not expressly approved by the party responsible for compliance could void the user's authority to operate the equipment.
2. Shielded interface cables must be used in order to comply with the emission limits.

Table of Contents

Copyright.....	2	DVI-I Port	23
Trademarks	2	RJ45 LAN Ports	23
FCC and DOC Statement on Class B.....	2	USB Ports	24
About this Manual	4	Audio	25
Warranty.....	4	I/O Connectors	26
Static Electricity Precautions.....	4	CD-in Internal Audio Connector	26
Safety Measures	4	S/PDIF Connector	26
About the Package.....	5	LVDS LCD Panel Connector and LCD/Inverter Power Connector	27
Chapter 1 - Introduction	6	SATA (Serial ATA) Connectors	28
Overview	6	Digital I/O Connectors	28
Key Features	6	Cooling Fan Connectors	29
Specifications	7	Chassis Intrusion Connector	29
Getting to Know the DT122-HR	8	Power Connectors	30
Mechanical Dimensions	9	Front Panel Connector	30
Motherboard Dimensions	9	Standby Power LED	31
Chapter 2 - Getting Started.....	10	CompactFlash Socket	31
Preparing the System	10	Expansion Slots	32
Installing Devices	10	Battery	33
Configuring the BIOS	10	Chapter 6 - Mounting Options	34
Installing the Operating System	10	Chapter 7 - BIOS Setup	36
Installing the Drivers	10	Overview.....	36
Chapter 3 - Installing Devices	11	AMI BIOS Setup Utility.....	37
Installing a 2.5" or 3.5" SATA Drive	12	Main	37
Installing a 2.5" SATA Drive	12	Advanced	37
Installing a 3.5" SATA Drive	14	Chipset	46
Installing the PCI or PCIe x16 Expansion Card	15	Boot	49
Chapter 4 - Jumper Settings	17	Security	50
Clear CMOS	17	Save & Exit	50
PS/2 Power Select	17	Updating the BIOS	51
USB Power Select	18	Chapter 8 - Supported Software	52
Panel Power Select	18	Chapter 9 - Raid	62
COM 1 / COM 2 RS232/422/485 Select	19	RAID Levels	62
COM 1 / COM 2 RS232/Power Select	19	Settings	62
Power-on Select	20	Chapter 10 - Intel AMT Settings	65
Chapter 5 - Ports and Connectors.....	21	Overview.....	65
Rear Panel I/O Ports	21	Enable Intel® AMT in the AMI BIOS	65
PS/2 Mouse and PS/2 Keyboard	21	Enable Intel® AMT in the Intel® Management Engine BIOS	
COM (Serial) Ports	22	Extension (MEBX) Screen	66
VGA Port	22	Appendix A - NLITE and AHCI Installation Guide	81
DVI-I Port	23	Appendix B - Watchdog Sample Code	87
RJ45 LAN Ports	23	Appendix C - System Error Message	88
USB Ports	24	Appendix D - Troubleshooting Checklist	89
Audio	25		
I/O Connectors	26		
CD-in Internal Audio Connector	26		
S/PDIF Connector	26		
LVDS LCD Panel Connector and LCD/Inverter Power Connector	27		
SATA (Serial ATA) Connectors	28		
Digital I/O Connectors	28		
Cooling Fan Connectors	29		
Chassis Intrusion Connector	29		
Power Connectors	30		
Front Panel Connector	30		
Standby Power LED	31		
CompactFlash Socket	31		
Expansion Slots	32		
Battery	33		

About this Manual

An electronic file of this manual can be obtained from the DFI website at www.dfi.com. To download the user's manual from our website, please go to "Support" > "Download Center." On the Download Center page, select your product or type the model name and click "Search" to find all technical documents including the user's manual for a specific product.

Warranty

1. Warranty does not cover damages or failures that arised from misuse of the product, inability to use the product, unauthorized replacement or alteration of components and product specifications.
2. The warranty is void if the product has been subjected to physical abuse, improper installation, modification, accidents or unauthorized repair of the product.
3. Unless otherwise instructed in this user's manual, the user may not, under any circumstances, attempt to perform service, adjustments or repairs on the product, whether in or out of warranty. It must be returned to the purchase point, factory or authorized service agency for all such work.
4. We will not be liable for any indirect, special, incidental or consequential damages to the product that has been modified or altered.

Static Electricity Precautions

It is quite easy to inadvertently damage your PC, system board, components or devices even before installing them in your system unit. Static electrical discharge can damage computer components without causing any signs of physical damage. You must take extra care in handling them to ensure against electrostatic build-up.

1. To prevent electrostatic build-up, leave the system board in its anti-static bag until you are ready to install it.
2. Wear an antistatic wrist strap.
3. Do all preparation work on a static-free surface.
4. Hold the device only by its edges. Be careful not to touch any of the components, contacts or connections.
5. Avoid touching the pins or contacts on all modules and connectors. Hold modules or connectors by their ends.

Important:



Electrostatic discharge (ESD) can damage your processor, disk drive and other components. Perform the upgrade instruction procedures described at an ESD workstation only. If such a station is not available, you can provide some ESD protection by wearing an antistatic wrist strap and attaching it to a metal part of the system chassis. If a wrist strap is unavailable, establish and maintain contact with the system chassis throughout any procedures requiring ESD protection.

Safety Measures

To avoid damage to the system:

- Use the correct AC input voltage range.

To reduce the risk of electric shock:

- Unplug the power cord before removing the system chassis cover for installation or servicing. After installation or servicing, cover the system chassis before plugging the power cord.

Battery:

- Danger of explosion if battery incorrectly replaced.
- Replace only with the same or equivalent type recommend by the manufacturer.
- Dispose of used batteries according to local ordinance.

Safety Precautions

- Use the correct DC input voltage range.
- Unplug the power cord before removing the system chassis cover for installation or servicing. After installation or servicing, cover the system chassis before plugging the power cord.
- Danger of explosion if battery incorrectly replaced.
- Replace only with the same or equivalent type recommend by the manufacturer.
- Dispose of used batteries according to local ordinance.
- Keep this system away from humidity.
- Place the system on a stable surface. Dropping it or letting it fall may cause damage.
- The openings on the system are for air ventilation to protect the system from overheating. **DO NOT COVER THE OPENINGS.**
- Place the power cord in such a way that it will not be stepped on. Do not place anything on top of the power cord. Use a power cord that has been approved for use with the system and that it matches the voltage and current marked on the system's electrical range label.
- If the system will not be used for a long time, disconnect it from the power source to avoid damage by transient overvoltage.
- If one of the following occurs, consult a service personnel:
 - The power cord or plug is damaged.
 - Liquid has penetrated the system.
 - The system has been exposed to moisture.
 - The system is not working properly.
 - The system dropped or is damaged.
 - The system has obvious signs of breakage.
- The unit uses a three-wire ground cable which is equipped with a third pin to ground the unit and prevent electric shock. Do not defeat the purpose of this pin. If your outlet does not support this kind of plug, contact your electrician to replace the outlet.
- Disconnect the system from the DC outlet before cleaning. Use a damp cloth. Do not use liquid or spray detergents for cleaning.

About the Package

The package contains the following items. If any of these items are missing or damaged, please contact your dealer or sales representative for assistance.

- 1 DT122-HR system unit
- 1 CPU cooler
- 1 HDD drive bay kit
- 1 Quick Installation Guide

Optional Items

- Power Cord

The board and accessories in the package may not come similar to the information listed above. This may differ in accordance to the sales region or models in which it was sold. For more information about the standard package in your region, please contact your dealer or sales representative.

Before Using the System

Before powering-on the system, prepare the basic system components.

If you are installing the system board in a new system, you will need at least the following internal components.

- Memory module
- Storage devices such as hard disk drive, CD-ROM, etc.

You will also need external system peripherals you intend to use which will normally include at least a keyboard, a mouse and a video display monitor.

Chapter 1 - Introduction

Overview





Key Features

	DT122-HR
PROCESSOR	3rd/2nd Generation Intel® Core™ processors (under 45W)
CHIPSET	Intel® QM67
LAN	2 LAN ports
COM	2 COM ports
DISPLAYS	DVI-I (DVI-D Signal), 1 VGA
USB	4 Type A USB 2.0/1.1 ports 2 Type A USB 2.0/1.1 ports (optional)
AUDIO	Mic-in, Line-in, Line-out

Specifications

Processor System	<ul style="list-style-type: none"> Processors: <ul style="list-style-type: none"> 3rd Generation Intel® Core™ processors (22nm process technology) <ul style="list-style-type: none"> Intel® Core™ i7-3610QE (6M Cache, up to 3.3 GHz); 45W Intel® Core™ i5-3610ME (3M Cache, up to 3.3 GHz); 35W Intel® Core™ i3-3120ME (3M Cache, 2.4 GHz); 35W 2nd Generation Intel® Core™ processors (32nm process technology) <ul style="list-style-type: none"> Intel® Core™ i7-2710QE (6M Cache, up to 3.0 GHz); 45W Intel® Core™ i5-2510E (3M Cache, up to 3.1 GHz); 35W Intel® Core™ i3-2330E (3M Cache, 2.2 GHz); 35W Intel® Celeron® B810 (2M Cache, 1.6 GHz); 35W Intel QM67 Express chipset
Memory	<ul style="list-style-type: none"> Two DDR3 SODIMM sockets Supports DDR3 1333/1600MHz (3rd generation processors) Supports DDR3 1066/1333MHz (2nd generation processors) Supports up to 16GB memory
Graphics	<ul style="list-style-type: none"> Intel® HD Graphics Display ports: DVI-I (DVI-D signal) and VGA DVI-I supports up to 1920x1200 @ 60Hz resolution VGA supports up to 2048x1536 @ 75Hz resolution
Storage	<ul style="list-style-type: none"> Up to 2 2.5" or 1 3.5" SATA drive bay 1 optical drive bay (optional)
Ethernet	<ul style="list-style-type: none"> Intel® W82579LM with iAMT7.0 Gigabit Ethernet Phy Realtek® RTL8111DL PCI Express Gigabit Ethernet controller
Audio	<ul style="list-style-type: none"> Realtek® ALC262 2-channel High Definition Audio
COM	<ul style="list-style-type: none"> 2 DB-9 RS232/422/485 COM ports 2 DB-9 RS232 COM ports (optional)
USB	<ul style="list-style-type: none"> 4 Type A USB 2.0/1.1 ports 2 Type A USB 2.0/1.1 ports (optional)
Power	<ul style="list-style-type: none"> Power type <ul style="list-style-type: none"> ATX Power input voltage <ul style="list-style-type: none"> AC 100-240V, 3.5A, 150W
Cooling System	<ul style="list-style-type: none"> 1 CPU cooler
Environment	<ul style="list-style-type: none"> Temperature <ul style="list-style-type: none"> Operating: 0°C ~ 45°C Storage: -20°C ~ 60°C Humidity <ul style="list-style-type: none"> 90% RH at 45°C, 1 week
Vibration	<ul style="list-style-type: none"> Operating: 1G, 5~500Hz Non-operating: 1.5G, 5~25Hz IEC 68-2-64 compliant
Shock	<ul style="list-style-type: none"> Operating: 3G peak acceleration (11 msec. duration) Non-operating: 10G peak acceleration (11 msec. duration) IEC 68-2-27 compliant

I/O Ports	<ul style="list-style-type: none"> Front Panel <ul style="list-style-type: none"> 1 Power button 1 Reset button 2 LED indicators: Power, HDD Rear Panel <ul style="list-style-type: none"> 1 PS/2 Mouse 1 PS/2 Keyboard 2 DB-9 RS232/422/485 COM 1 DB-15 VGA 1 DVI-I (DVI-D signal) 2 RJ45 LAN
Expansion	<ul style="list-style-type: none"> 1 expansion slot <ul style="list-style-type: none"> 1 PCIe x16 or 1 PCI slot
Construction	<ul style="list-style-type: none"> Front panel: aluminum Rear chassis: sheet metal
Mounting	<ul style="list-style-type: none"> 2 types of wall mount bracket <ul style="list-style-type: none"> Type A  Type B  Brackets and screws (optional)
Dimensions	<ul style="list-style-type: none"> 300mm x 75mm x 217mm (W x H x D)
Weight	<ul style="list-style-type: none"> 3.7 kg
OS Support	<ul style="list-style-type: none"> Windows 7, Windows 7 Embedded, Windows XP, Windows XP Embedded, Linux Kernel 2.6

Getting to Know the DT122-HR

Front View

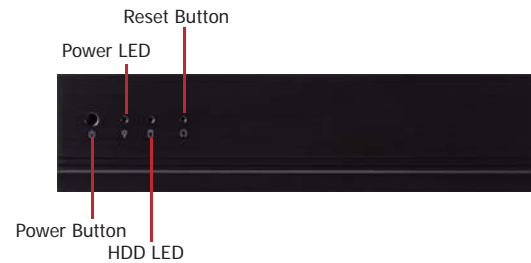

Power Button

Press to power-on or power-off the system.

Reset Button

Press to reset the system.

HDD LED

Indicates the status of the hard drive.

Power LED

Indicates the power status of the system.

Rear View

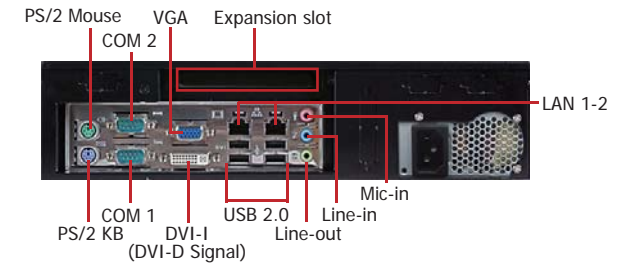

VGA Port

Use to connect a VGA device.

DVI-I Port

Used to connect a DVI device.

COM Ports

Used to connect serial devices.

USB Ports

Used to connect USB 3.0/2.0/1.1 devices.

LAN Ports

Used to connect the system to a local area network.

Line-out

Used to connect to a speaker.

Line-in

Used to connect any audio devices such as Hi-fi set, CD player, tape player, AM/FM radio tuner, synthesizer, etc.

Mic-in

Used to connect an external microphone.

PS/2 KB/Mouse

Used to connect a PS/2 keyboard and PS/2 mouse.

Expansion Slot

Used to insert an expansion card.

Mechanical Dimensions

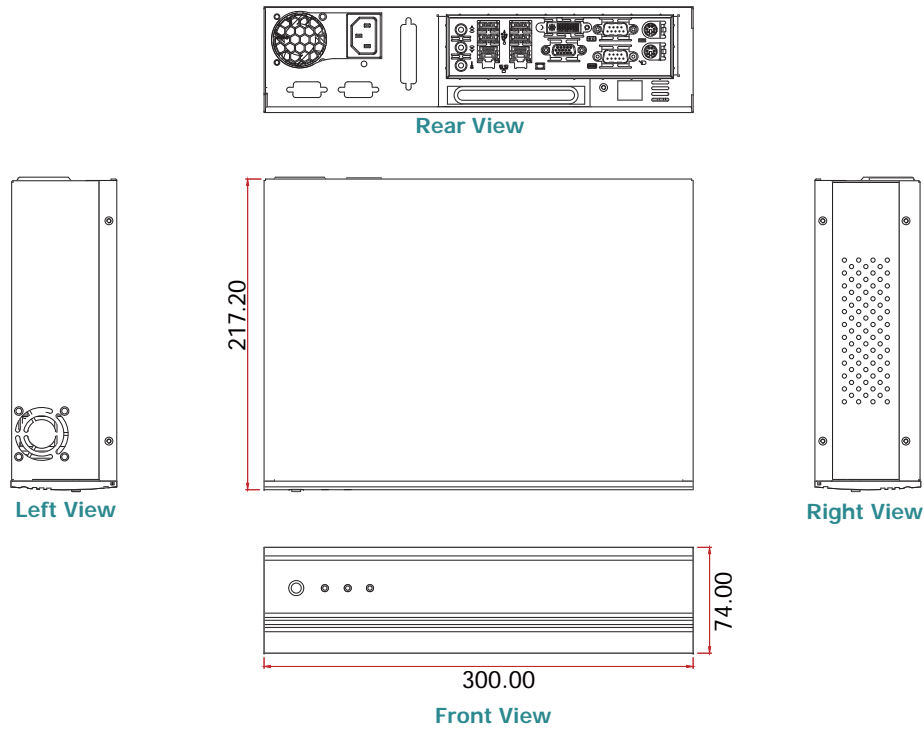

Motherboard Dimensions

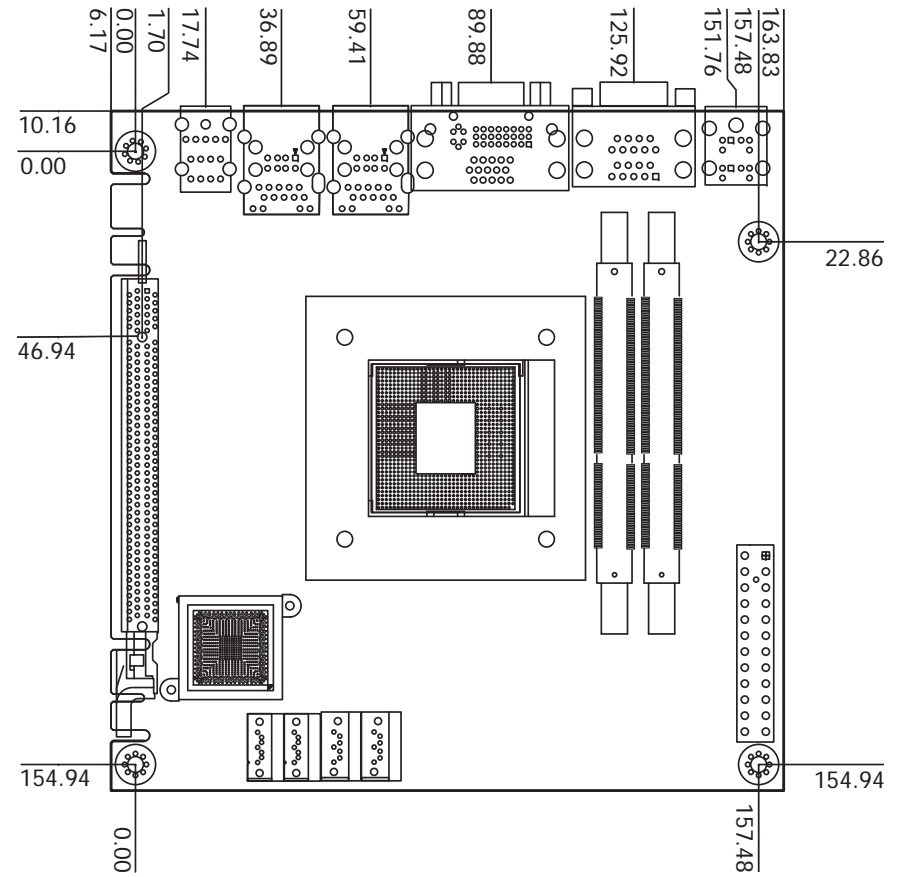

Chapter 2 - Getting Started

Preparing the System

Before you start using the system, you need the following items:

- SATA hard drive
- AC power adapter
- PS/2 or USB keyboard
- PS/2 or USB mouse
- CD-ROM drive (for installing software/drivers)
- Screwdriver
- Memory module (optional)

Installing Devices

The following are devices that can be installed in the system.

- Memory module
- SATA hard drive

Configuring the BIOS

To get you started, you may need to change configurations such as the date, time and the type of hard disk drive.

1. Power-on the system.
2. After the memory test, the message "Press DEL to run setup" will appear on the screen. Press the Delete key to enter the AMI BIOS setup utility.

Installing the Operating System

Most operating system software can be installed using a DVD (and DVD burner) or bootable USB drive.

Please refer to your operating system manual for instructions on installing an operating system.

Installing the Drivers

The system requires you to install drivers for some devices to operate properly. Refer to the Supported Software chapter for instructions on installing the drivers.

Chapter 3 - Installing Devices

1. Make sure the system and all other peripheral devices connected to it has been powered-off.
2. Disconnect all power cords and cables.
3. The 4 mounting screws on the sides of the system are used to secure the cover to the chassis. Remove these screws and then put them in a safe place for later use.



4. After removing the mounting screws, slide the cover backwards.



5. The DIMM sockets and SATA drive bay are readily accessible after removing the chassis cover.



Installing a 2.5" or 3.5" SATA Drive

Installing a 2.5" SATA Drive

1. Remove the 4 mounting screws that secure the drive bay to the chassis and then remove the drive bay.

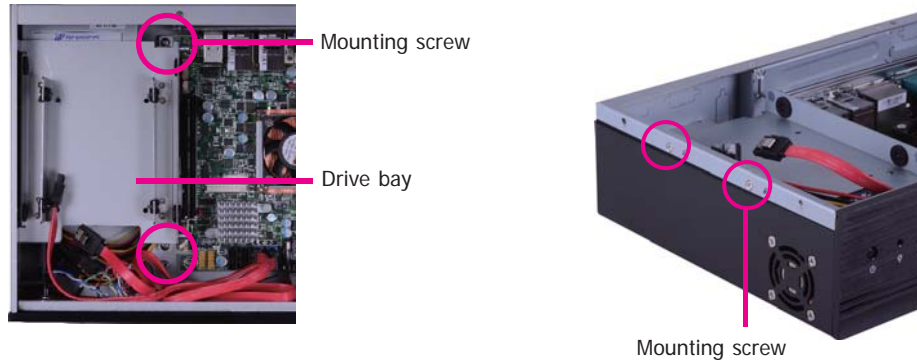

2. Turn to the other side of the drive bay and remove the 4 mounting screws that secure the HDD brackets to the drive bay.

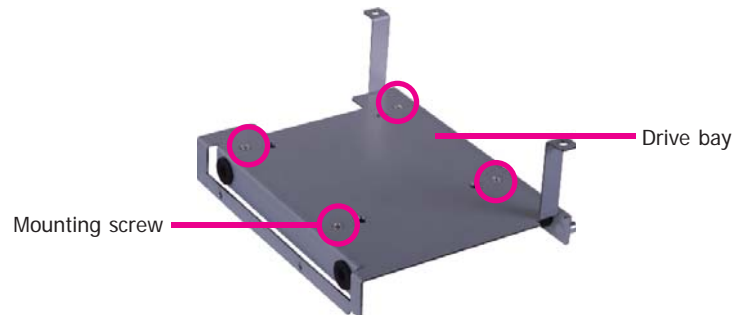

3. Align the mounting holes of the SATA drive with the mounting holes on the HDD bracket and then use the provided mounting screws to secure the drive in place.

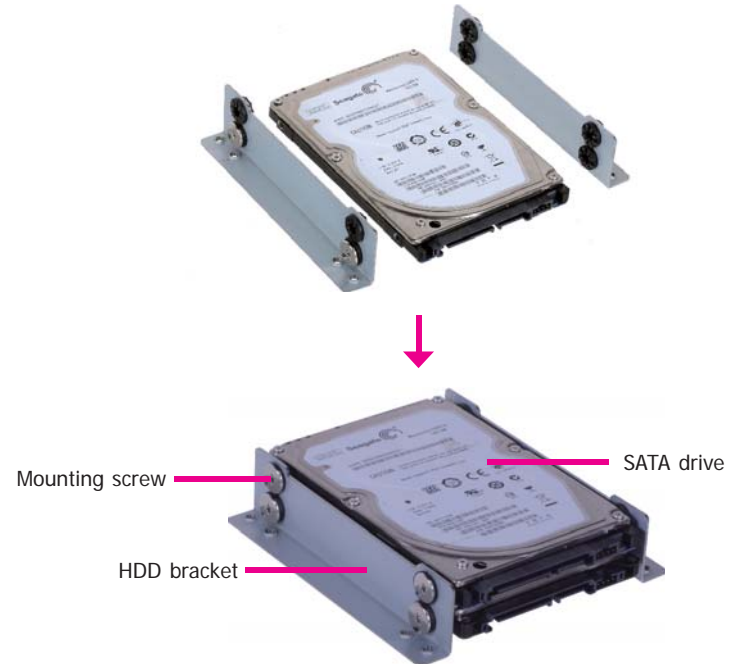
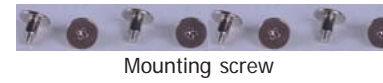

4. Turn to the other side of the drive bay. Use the provided mounting screws from step 2 to secure the SATA drive (with the HDD bracket) onto the drive bay.

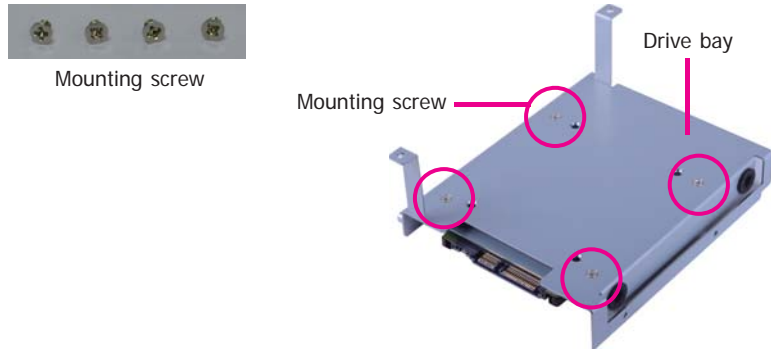

6. Connect the SATA data cable and SATA power cable to the connectors on the SATA drive.



5. Place the SATA drive bay assembly into the chassis. Secure the SATA drive bay with the mounting screws you removed in step 1.

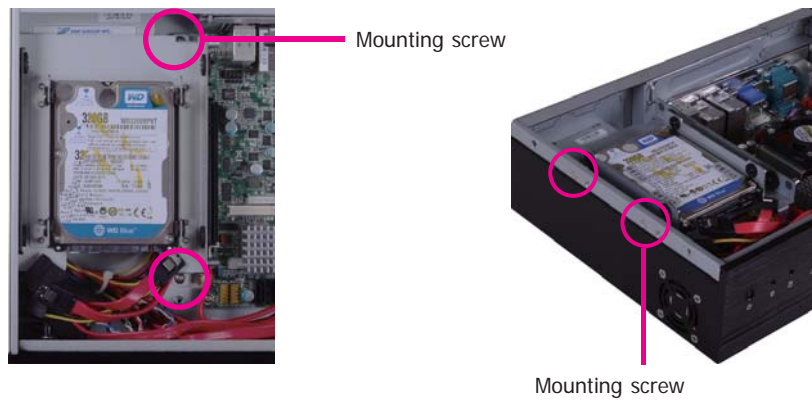

Installing a 3.5" SATA Drive

1. Remove the 4 mounting screws that secure the drive bay to the system.

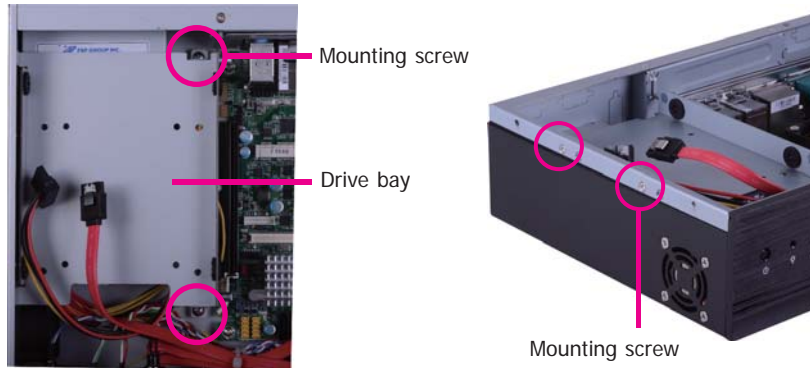

2. Insert the spacer into the anti-shock bumper. You will find the spacers in the HDD drive bay kit that comes with the DT122 package.

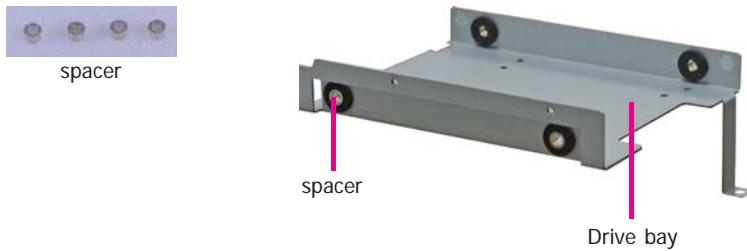

3. Place the SATA drive on the drive bay. Align the mounting holes of the SATA drive with the mounting holes on the drive bay.



4. Use the provided mounting screws to secure the SATA drive onto the drive bay.



5. Place the drive bay into the chassis. Secure the drive bay with the mounting screws you removed in step 1.

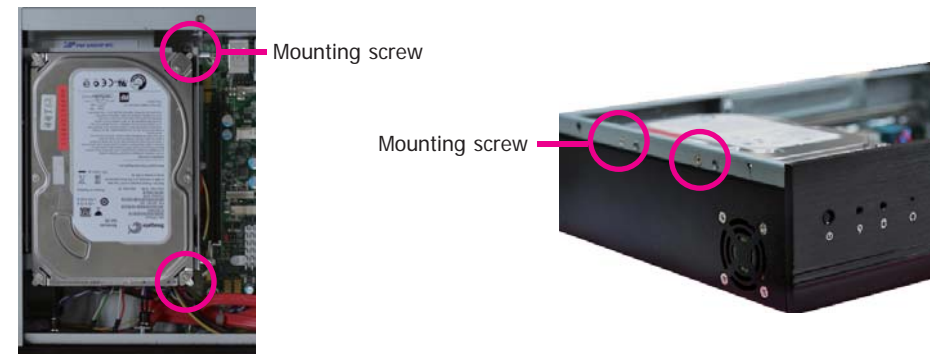

6. Connect the SATA data cable and SATA power cable to the connectors on the SATA drive.

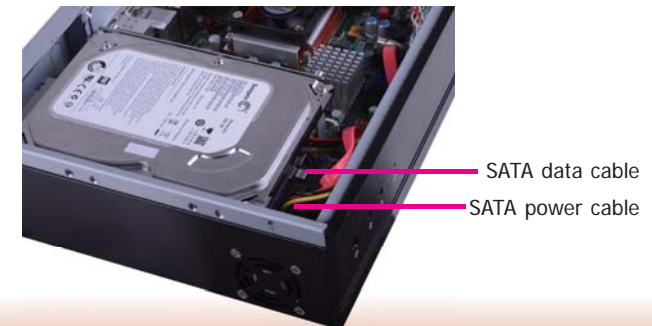

Installing the PCI or PCIe x16 Expansion Card



Important:

When inserting the riser card, please select a card within 175mm (as shown on the next picture).



1. The PCIe x16 on the motherboard is used to insert a TS200-1P or TS200-1E riser card.

To install the expansion card, you need to remove the mounting bracket and the mounting screw that secure the bracket to the chassis and then remove the bracket. Put the screw and the brackets in a safe place for later use.

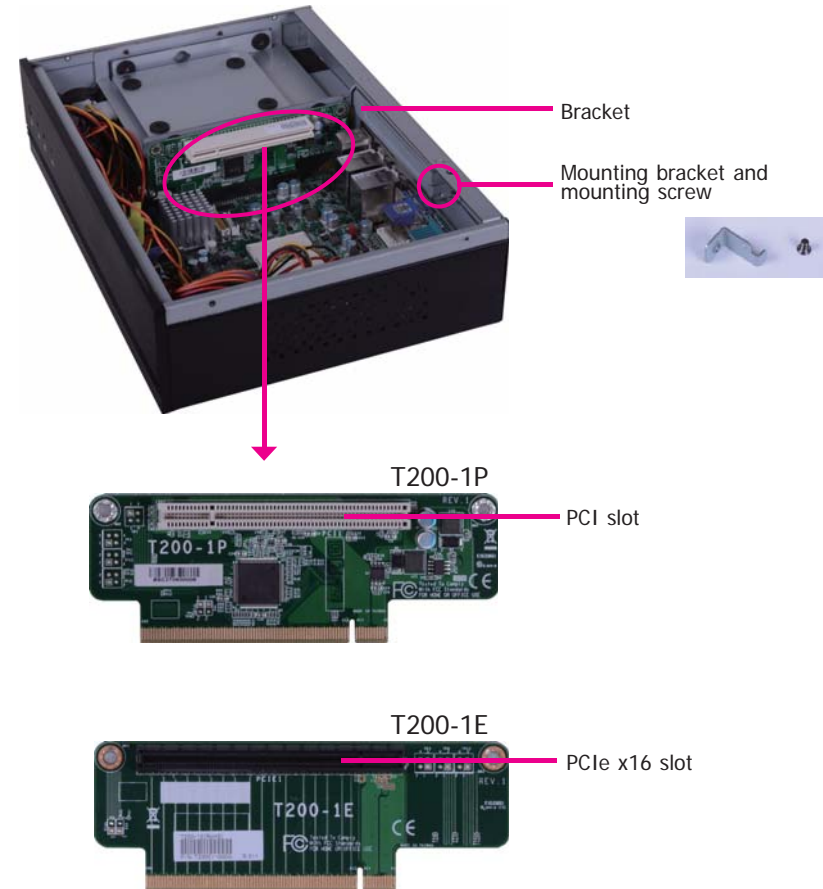

2. Insert the Expansion card with a bracket into the PCI or PCIe x16 slot that is on the riser card. Replace the screw you removed in step 1 to secure the bracket in place.

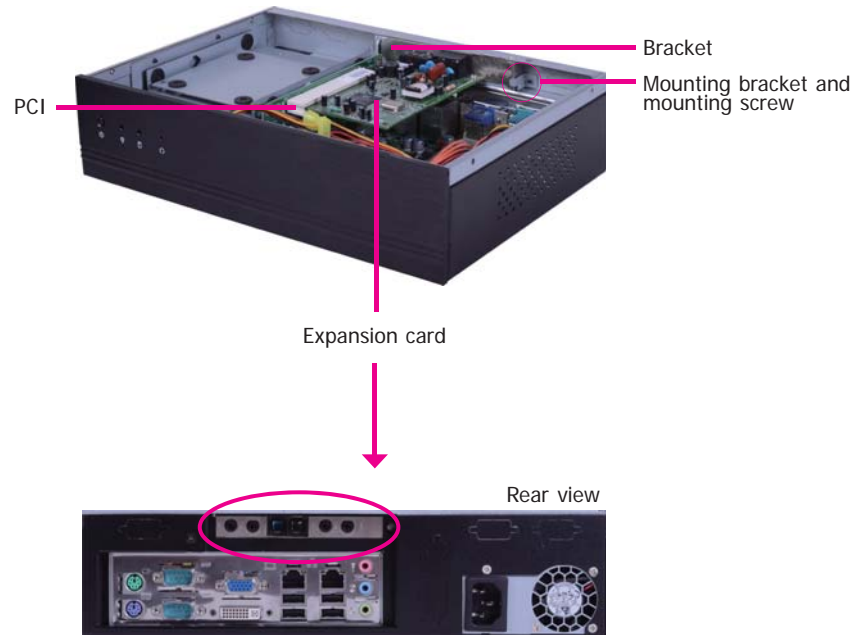
**Note:**

The Expansion card used in the above illustrations may not resemble the actual cards. These illustrations are for reference only.

Chapter 4 - Jumper Settings

Clear CMOS

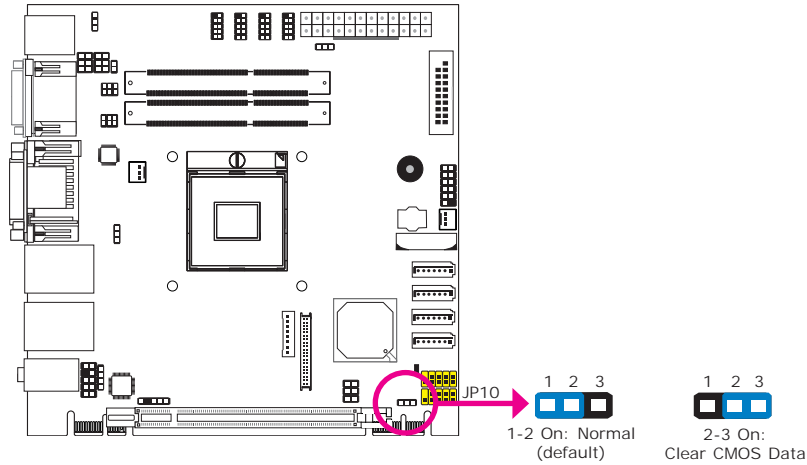

If you encounter the following,

- CMOS data becomes corrupted.
- You forgot the supervisor or user password.

you can reconfigure the system with the default values stored in the ROM BIOS.

To load the default values stored in the ROM BIOS, please follow the steps below.

- Power-off the system and unplug the power cord.
- Set JP10 pins 2 and 3 to On. Wait for a few seconds and set JP10 back to its default setting, pins 1 and 2 On.
- Now plug the power cord and power-on the system.

PS/2 Power Select

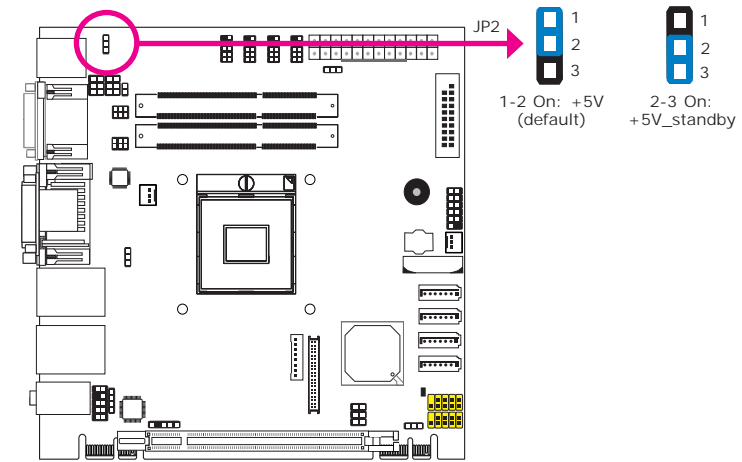

JP2 is used to select the power of the PS/2 keyboard and PS/2 mouse ports. Selecting +5V_standby will allow you to use the PS/2 keyboard or PS/2 mouse to wake up the system.



Important:

The +5VSB power source of your power supply must support $\geq 720\text{mA}$.

USB Power Select

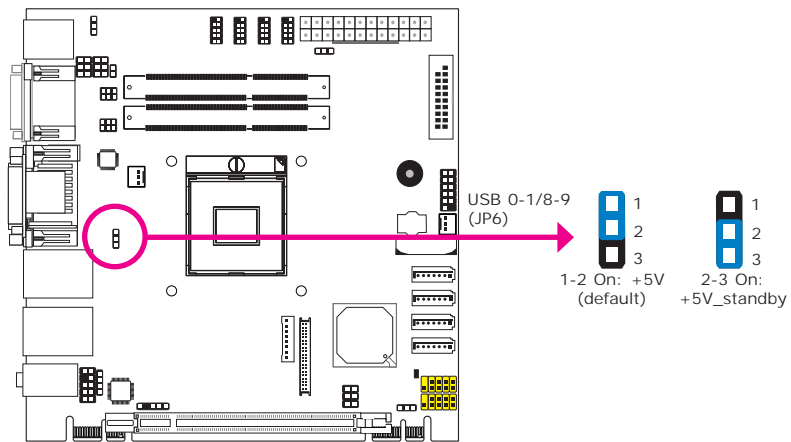

This jumper is used to select the power of the USB ports. Selecting +5V_standby will allow you to use a USB device to wake up the system.



Important:

If you are using the Wake-On-USB Keyboard/Mouse function for 2 USB ports, the +5V_standby power source of your power supply must support $\geq 1.5A$. For 3 or more USB ports, the +5V_standby power source of your power supply must support $\geq 2A$.

Panel Power Select

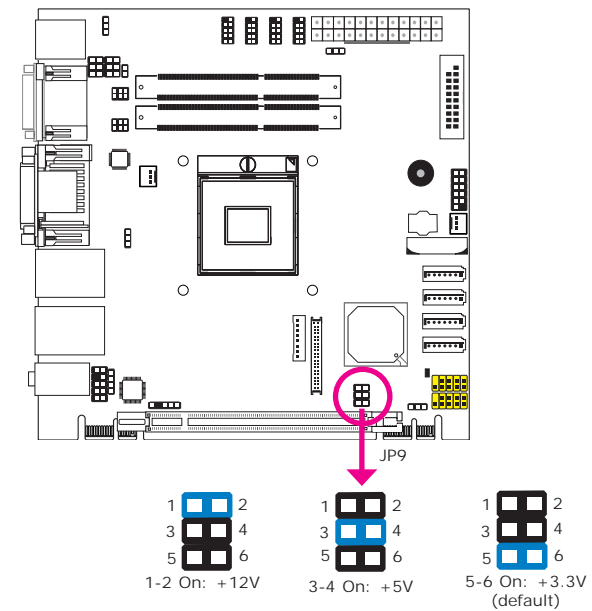

JP9 is used to select the power supplied to the LCD panel.



Important:

Before powering-on the system, make sure JP9's setting matches the LCD panel's specification. Selecting the incorrect voltage will seriously damage the LCD panel.

COM 1/ COM 2 RS232/RS422/RS485 Select

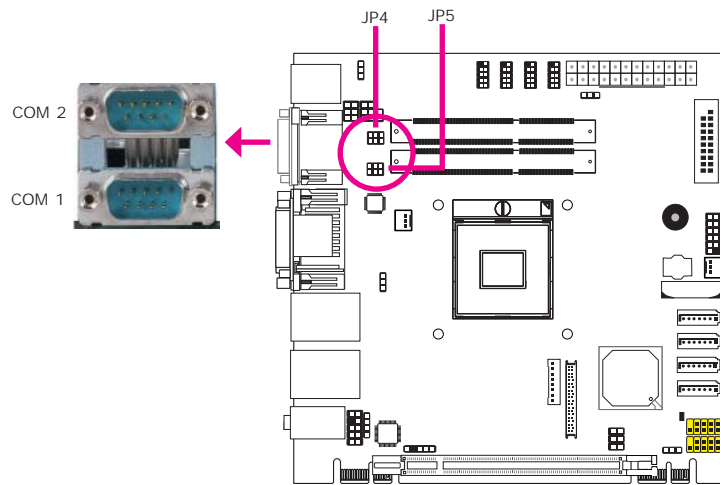

JP4 (for COM1) and JP5 (for COM2) are used to configure the COM ports to RS232, RS422 (Full Duplex) or RS485.

The pin function of the COM ports will vary according to the jumper's setting.

COM1/COM2 RS232/Power Select

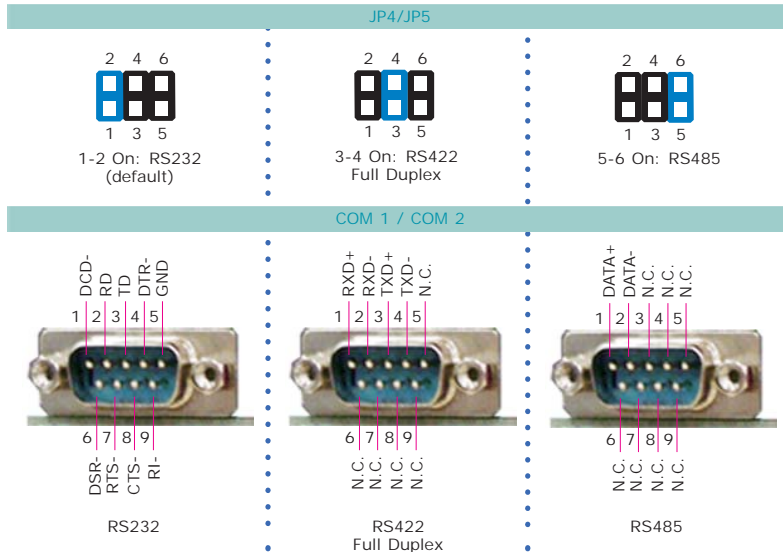
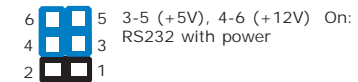
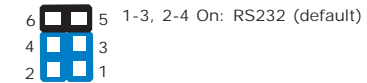
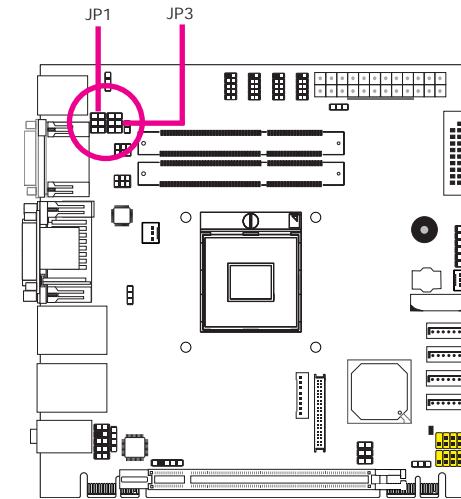

Power-on Select

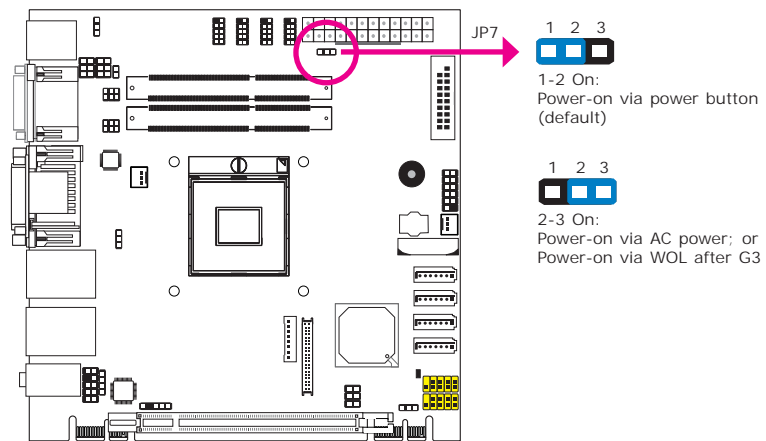

To power-on via WOL after G3:

1. Set JP7 pins 2 and 3 to On.
2. Set the "After G3" field to **Power Off/WOL**.
3. Set the "GbE Wake Up From S5" to **Enabled**.

The BIOS fields are in the "South Bridge Configuration" submenu (Chipset menu) of the AMI BIOS utility.

To power-on via AC Power:

1. Set JP7 pins 2 and 3 to On.
2. Set the "After G3" field to **Power On**.

Chapter 5 - Ports and Connectors

Rear Panel I/O Ports

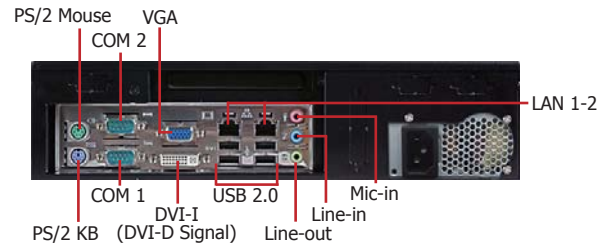

The rear panel I/O ports consist of the following:

- PS/2 mouse and PS/2 keyboard port
- COM port
- VGA port
- DVI-I port (DVI-D signal only)
- 2 Intel LAN ports
- 4 USB 2.0 ports
- Line-out jack
- Line-in jack
- Mic-in jack

PS/2 Mouse and PS/2 Keyboard

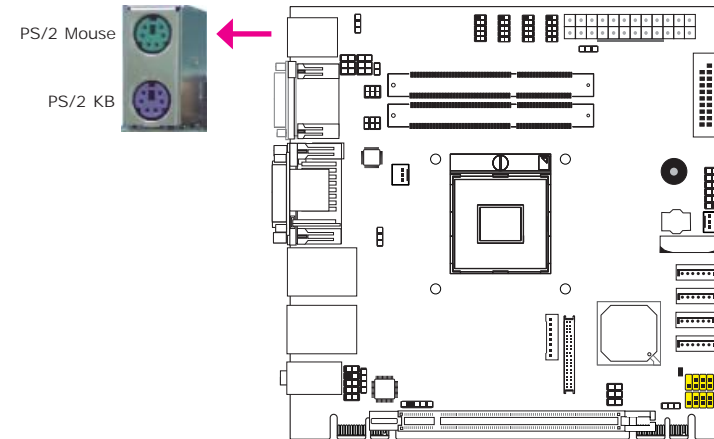

These ports are used to connect a PS/2 mouse and a PS/2 keyboard. The PS/2 mouse port uses IRQ12.

Wake-On-PS/2 Keyboard/Mouse

The Wake-On-PS/2 Keyboard/Mouse function allows you to use the PS/2 keyboard or PS/2 mouse to power-on the system. To use this function:

- **Jumper Setting**

JP2 must be set to "2-3 On: +5V_standby". Refer to "PS/2 Power Select" in this chapter for more information.

- **BIOS Setting**

Configure the PS/2 keyboard/mouse wake up function in the Advanced menu ("ACPI Power Management Configuration" submenu) of the BIOS. Refer to chapter 7 for more information.



Important:

The +5V_standby power source of your power supply must support $\geq 720\text{mA}$.

COM (Serial) Ports

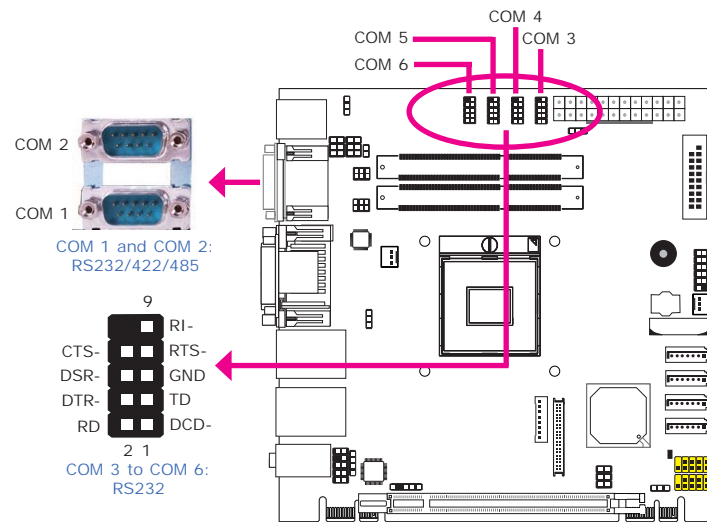

COM 3 to COM 6 are fixed at RS232.

The pin function of COM 1 and COM 2 ports will vary according to JP4/JP5's setting. Refer to "COM1/COM2 RS232/RS422/RS485 Select" in this chapter for more information.

The serial ports are asynchronous communication ports with 16C550A-compatible UARTs that can be used with modems, serial printers, remote display terminals, and other serial devices.

Connecting External Serial Ports

Your COM port may come mounted on a card-edge bracket. Install the card-edge bracket to an available slot at the rear of the system chassis then insert the serial port cable to the COM connector. Make sure the colored stripe on the ribbon cable is aligned with pin 1 of the COM connector.

BIOS Setting

Configure the serial ports in the Advanced menu ("Super IO Configuration" submenu) of the BIOS. Refer to chapter 3 for more information.

VGA Port

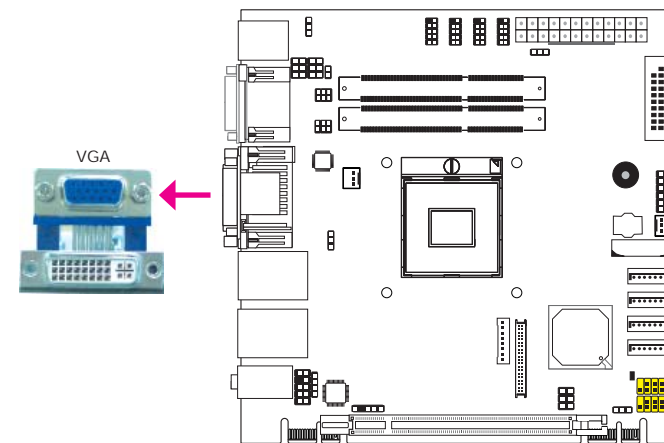

The VGA port is used for connecting a VGA monitor. Connect the monitor's 15-pin D-shell cable connector to the VGA port. After you plug the monitor's cable connector into the VGA port, gently tighten the cable screws to hold the connector in place.

BIOS Setting

Configure VGA in the Chipset menu ("North Bridge Configuration" submenu) of the BIOS. Refer to chapter 3 for more information.

Driver Installation

Install the graphics driver. Refer to chapter 4 for more information.

DVI-I Port

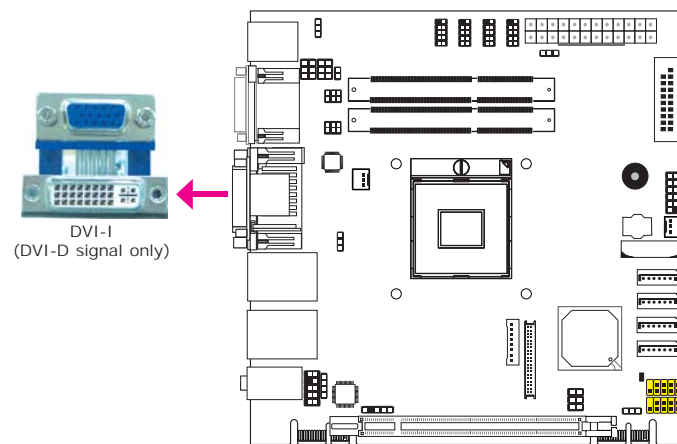

The DVI-I port is used to connect an LCD monitor. This port supports DVI-D signal only.

Connect the display device's cable connector to the DVI-I port. After you plug the cable connector into the port, gently tighten the cable screws to hold the connector in place.

BIOS Setting

Configure the display device in the Chipset menu ("North Bridge Configuration" submenu) of the BIOS. Refer to chapter 3 for more information.

RJ45 LAN Ports

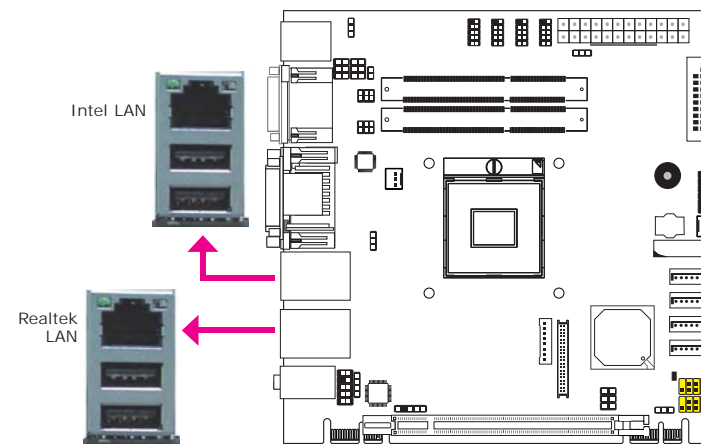

Features

- Intel 82579LM with iAMT7.0 Gigabit LAN Phy
- Realtek RTL8111DL PCI Express Gigabit LAN controller

The LAN ports allow the system board to connect to a local area network by means of a network hub.

BIOS Setting

Configure the onboard LAN in the Chipset menu ("South Bridge Configuration" submenu) of the BIOS. Refer to chapter 7 for more information.

Driver Installation

Install the LAN drivers. Refer to chapter 8 for more information.

USB Ports

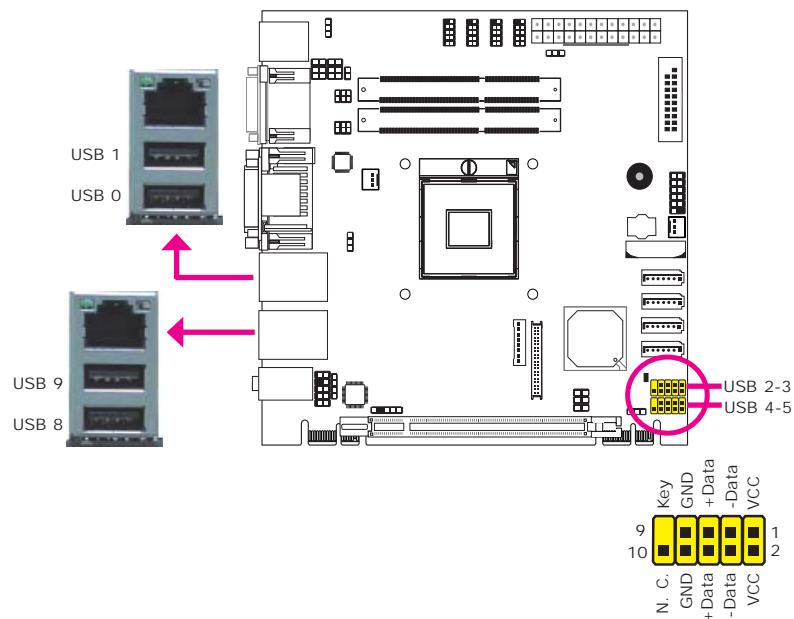

USB allows data exchange between your computer and a wide range of simultaneously accessible external Plug and Play peripherals.

The system board is equipped with four onboard USB 2.0/1.1 ports. The two 10-pin connectors allow you to connect 4 additional USB 2.0/1.1 ports. The additional USB ports may be mounted on a card-edge bracket. Install the card-edge bracket to an available slot at the rear of the system chassis and then insert the USB port cables to a connector.

BIOS Setting

Configure the onboard USB in the Advanced menu ("USB Configuration" submenu) of the BIOS. Refer to chapter 3 for more information.

Driver Installation

You may need to install the proper drivers in your operating system to use the USB device. Refer to your operating system's manual or documentation for more information.

Wake-On-USB Keyboard/Mouse

The Wake-On-USB Keyboard/Mouse function allows you to use a USB keyboard or USB mouse to wake up a system from the S3 (STR - Suspend To RAM) state. To use this function:

- **Jumper Setting**

JP6 must be set to "2-3 On: +5V_standby". Refer to "USB Power Select" in this chapter for more information.



Important:

If you are using the Wake-On-USB Keyboard/Mouse function for 2 USB ports, the +5V_standby power source of your power supply must support $\geq 1.5A$. For 3 or more USB ports, the +5V_standby power source of your power supply must support $\geq 2A$.

Audio

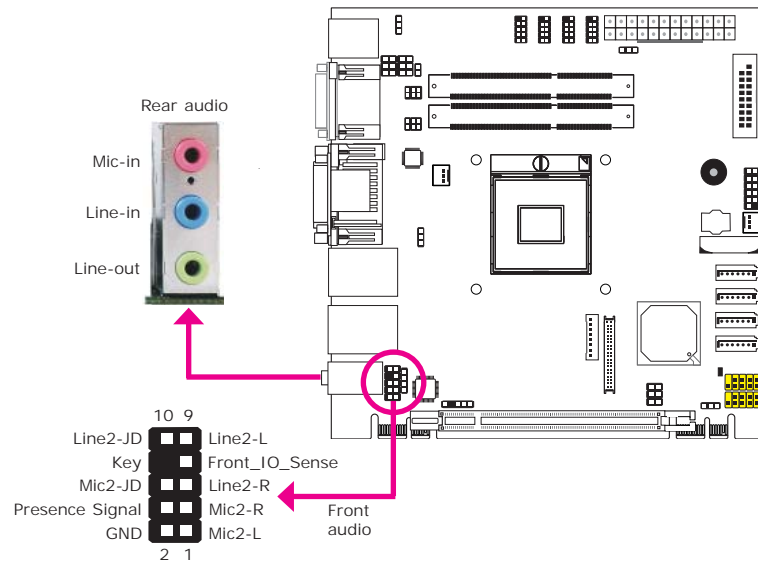

Rear Audio

The system board is equipped with 3 audio jacks. A jack is a one-hole connecting interface for inserting a plug.

- Mic-in Jack (Pink)
This jack is used to connect an external microphone.
- Line-in Jack (Light Blue)
This jack is used to connect any audio devices such as Hi-fi set, CD player, tape player, AM/FM radio tuner, synthesizer, etc.
- Line-out Jack (Lime)
This jack is used to connect a headphone or external speakers.

Front Audio

The front audio connector allows you to connect to the second line-out and mic-in jacks that are at the front panel of your system.

BIOS Setting

Configure the onboard audio in the Chipset menu ("South Bridge" submenu) of the BIOS. Refer to chapter 7 for more information.

Driver Installation

Install the audio driver. Refer to chapter 8 for more information.

I/O Connectors

CD-in Internal Audio Connector

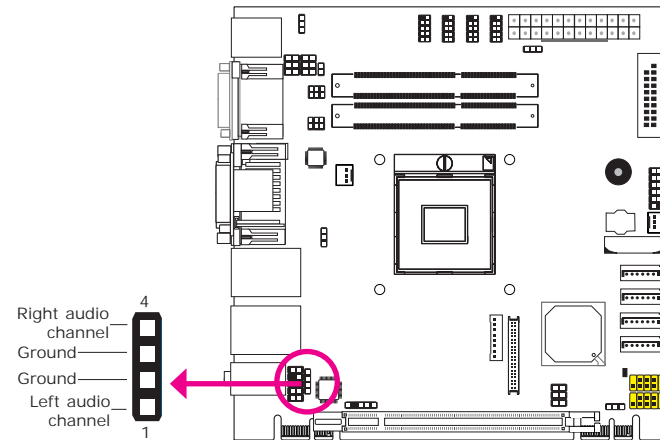

The CD-in connector is used to receive audio from a CD-ROM drive, TV tuner or MPEG card.

S/PDIF Connector

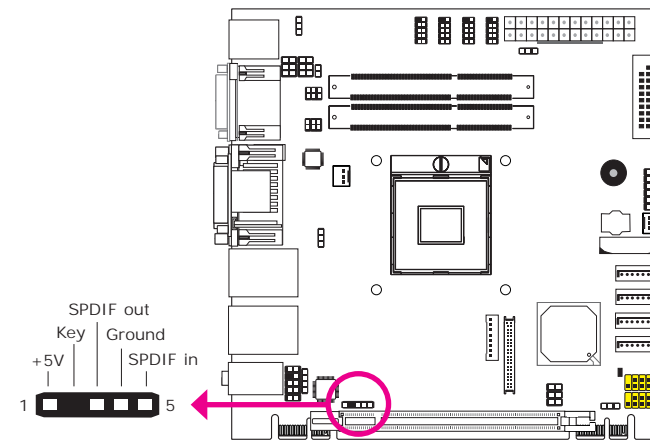

The S/PDIF connector is used to connect an external S/PDIF port. Your S/PDIF port may be mounted on a card-edge bracket. Install the card-edge bracket to an available slot at the rear of the system chassis then connect the audio cable to the S/PDIF connector. Make sure pin 1 of the audio cable is aligned with pin 1 of the S/PDIF connector.

LVDS LCD Panel Connector

LCD/Inverter Power Connector

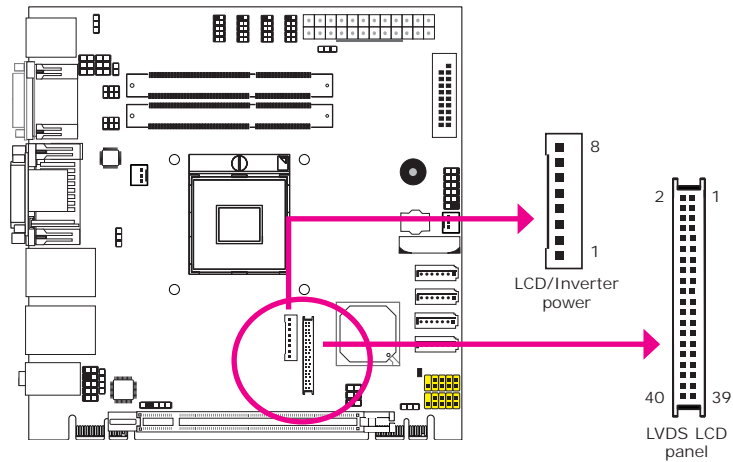

The system board allows you to connect a LCD Display Panel by means of the LVDS LCD panel connector and the LCD/Inverter power connector. These connectors transmit video signals and power from the system board to the LCD Display Panel.

Refer to the next page for the pin functions of these connectors.

BIOS Setting

Configure the LCD panel in the Advanced Chipset Features submenu of the BIOS. Refer to chapter 7 for more information.

LVDS LCD Panel Connector

Pins	Function	Pins	Function
1	GND	2	GND
3	LVDS_Out3+	4	LVDS_Out7+
5	LVDS_Out3-	6	LVDS_Out7-
7	GND	8	GND
9	LVDS_Out2+	10	LVDS_Out6+
11	LVDS_Out2-	12	LVDS_Out6-
13	GND	14	GND
15	LVDS_Out1+	16	LVDS_Out5+
17	LVDS_Out1-	18	LVDS_Out5-
19	GND	20	GND
21	LVDS_Out0+	22	LVDS_Out4+
23	LVDS_Out0-	24	LVDS_Out4-
25	GND	26	GND
27	LVDS_CLK1+	28	LVDS_CLK2+
29	LVDS_CLK1-	30	LVDS_CLK2-
31	GND	32	GND
33	LVDS_DDCCLK	34	N.C.
35	LVDS_DDCDAA	36	N.C.
37	Panel Power	38	Panel Power
39	Panel Power	40	Panel Power

LCD/Inverter Power Connector

Pins	Function
1	GND
2	GND
3	Panel Inverter Brightness Voltage Control
4	Panel Power
5	+3.3V
6	Panel Backlight On/Off Control
7	+12V
8	+12V

Digital I/O Connectors

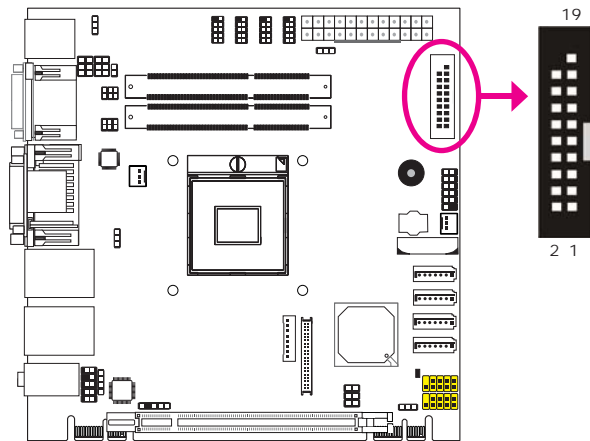

The 8-bit Digital I/O connector provides powering-on function to external devices that are connected to these connectors.

Pin	Pin Assignment	Pin	Pin Assignment
1	GND	2	+12V
3	DIO7	4	+12V
5	DIO6	6	GND
7	DIO5	8	VCC
9	DIO4	10	VCC
11	DIO3	12	GND
13	DIO2	14	V_5P0_STBY
15	DIO1	16	V_5P0_STBY
17	DIO0	18	GND
19	GND		

SATA (Serial ATA) Connectors

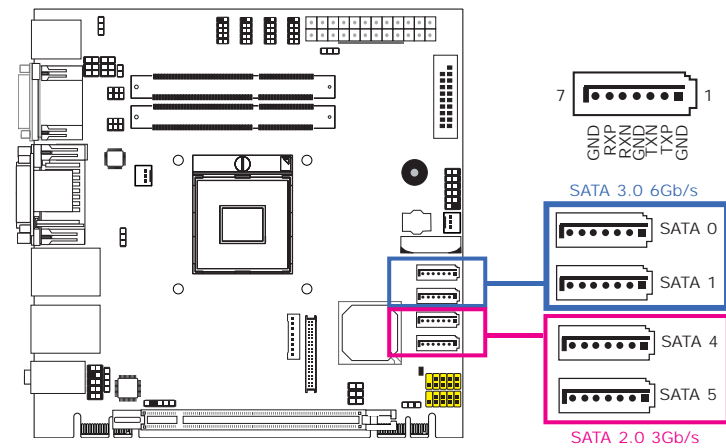

Features

- 4 Serial ATA ports
 - 2 SATA2 ports with data transfer rate up to 3Gb/s
 - 2 SATA3 ports with data transfer rate up to 6Gb/s
- Integrated Advanced Host Controller Interface (AHCI) controller
- Supports RAID 0, RAID 1, RAID 5 and RAID 10

The Serial ATA connectors are used to connect Serial ATA devices. Connect one end of the Serial ATA cable to a SATA connector and the other end to your Serial ATA device.

BIOS Setting

Configure the Serial ATA drives in the Advanced menu ("IDE Configuration" submenu) of the BIOS. Refer to chapter 6 for more information.

Cooling Fan Connectors

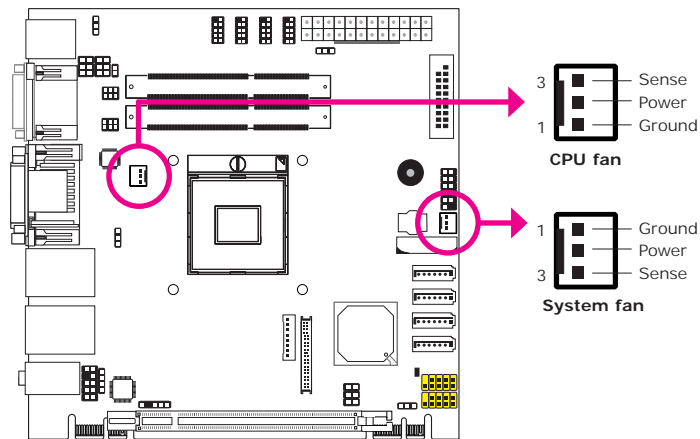

The fan connectors are used to connect cooling fans. The cooling fans will provide adequate airflow throughout the chassis to prevent overheating the CPU and system board components.

BIOS Setting

The Advanced menu (“Hardware Health Configuration” submenu) of the BIOS will display the current speed of the cooling fans. Refer to chapter 6 for more information.

Chassis Intrusion Connector

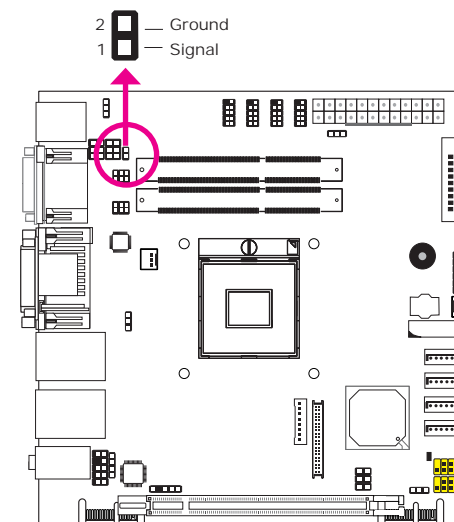

The board supports the chassis intrusion detection function. Connect the chassis intrusion sensor cable from the chassis to this connector. When the system’s power is on and a chassis intrusion occurred, an alarm will sound. When the system’s power is off and a chassis intrusion occurred, the alarm will sound only when the system restarts.

MyGuard Hardware Monitor

Install the “MyGuard Hardware Monitor” utility. By default, the chassis intrusion detection function is disabled. When enabled, a warning message will appear when the chassis is open. The utility can also be configured so that a beeping alarm will sound when the chassis is open. Refer to the “MyGuard Hardware Monitor” section in chapter 4 for more information.

Power Connectors

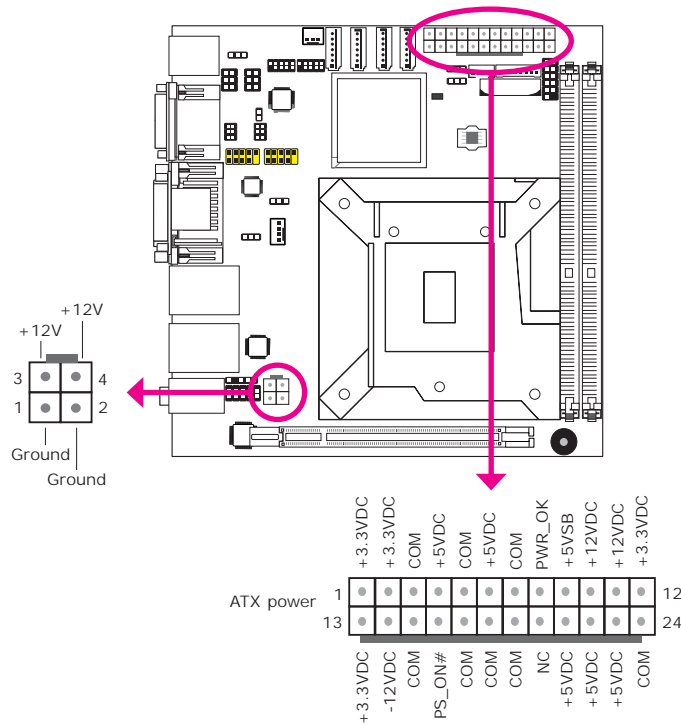

Use a power supply that complies with the ATX12V Power Supply Design Guide Version 1.1. An ATX12V power supply unit has a standard 24-pin ATX main power connector that must be inserted into the 24-pin connector. The 4-pin +12V power connector enables the delivery of more +12VDC current to the processor's Voltage Regulator Module (VRM).

The power connectors from the power supply unit are designed to fit the 24-pin and 4-pin connectors in only one orientation. Make sure to find the proper orientation before plugging the connectors.

Important: Insufficient power supplied to the system may result in instability or the add-in boards and peripherals not functioning properly. Calculating the system's approximate power usage is important to ensure that the power supply meets the system's consumption requirements.

Front Panel Connectors

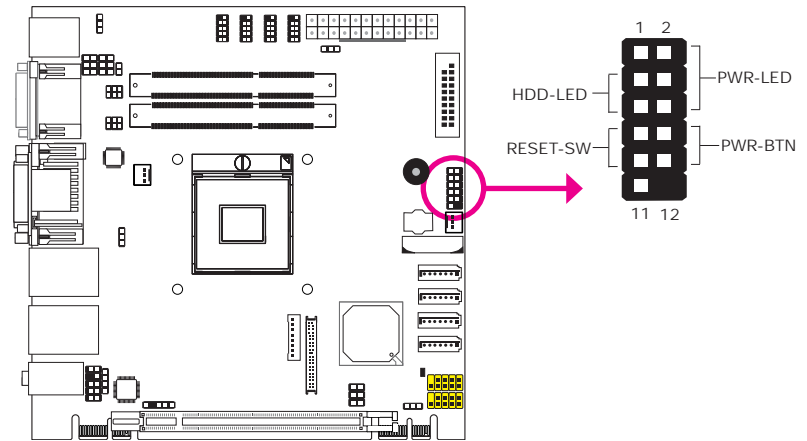

HDD-LED - HDD LED

This LED will light when the hard drive is being accessed.

RESET SW - Reset Switch

This switch allows you to reboot without having to power off the system.

PWR-BTN - Power Switch

This switch is used to power on or off the system.

PWR-LED - Power/Standby LED

When the system's power is on, this LED will light. When the system is in the S1 (POS - Power On Suspend) state, it will blink every second. When the system is in the S3 (STR - Suspend To RAM) state, it will blink every 4 seconds.

	Pin	Pin Assignment		Pin	Pin Assignment
HDD-LED	3	HDD Power	PWR-LED	2	LED Power
	5	Signal		4	LED Power
RESET SW	7	Ground	PWR-BTN	6	Signal
	9	RST Signal		8	Ground
	11	N.C.		10	Signal

Standby Power LED

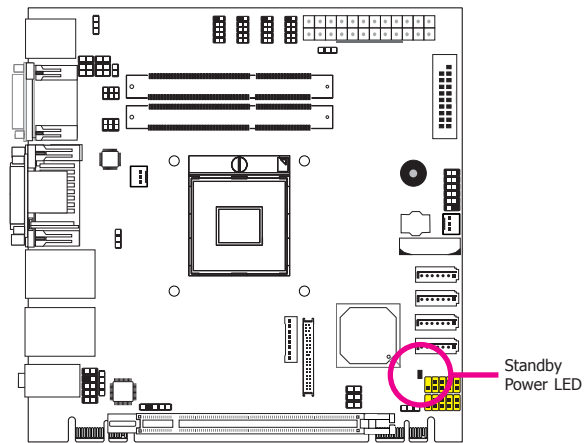

This LED will lit red when the system is in the standby mode. It indicates that there is power on the system board. Power-off the PC and then unplug the power cord prior to installing any devices. Failure to do so will cause severe damage to the motherboard and components.

CompactFlash Socket

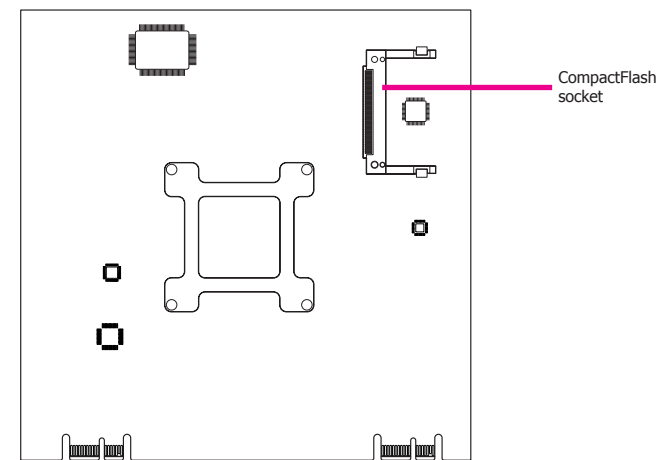

The CompactFlash™ socket is used for inserting a CompactFlash™ card. CompactFlash™ card is a small removable mass storage device designed with flash technology - a non-volatile storage solution that does not require a battery to retain data indefinitely. The CompactFlash™ technology is widely used in products such as portable and desktop computers, digital cameras, hand-held data collection scanners, PDAs, Pocket PCs, handy terminals and personal communicators.

Expansion Slots

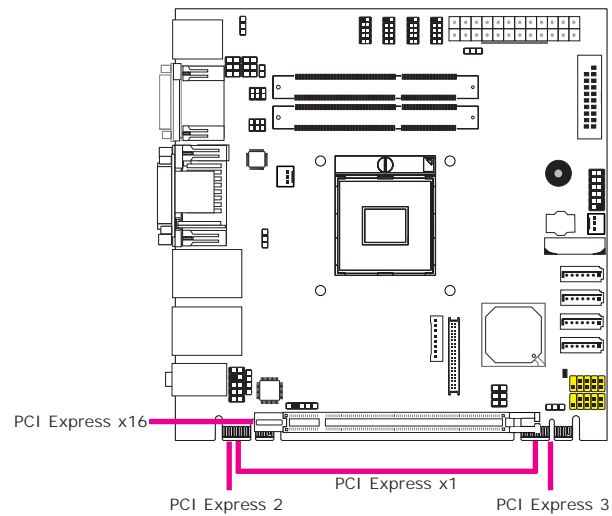

PCI Express x16 Slot

Install PCI Express x16 graphics card, that comply to the PCI Express specifications, into the PCI Express x16 slot. To install a graphics card into the x16 slot, align the graphics card above the slot then press it down firmly until it is completely seated in the slot. The retaining clip of the slot will automatically hold the graphics card in place.

PCI Express x1

Two PCIe x1 gold fingers for customized expansion (PCI or Mini PCIe) via a riser card.

PCIe 2			
Pin	Pin Assignment	Pin	Pin Assignment
A1	GND	B1	+12V
A2	+12V	B2	+12V
A3	+12V	B3	+12V
A4	GND	B4	GND
A5	+5V	B5	SMB_CLK
A6	+5V	B6	SMB_DATA
A7	+5V	B7	GND
A8	+5V	B8	+3V3
A9	+3V3	B9	NC
A10	+3V3	B10	+3V3DU
A11	RESET	B11	PCIE_WAKE
A12	GND	B12	PME
A13	CLK+	B13	GND
A14	CLK-	B14	TX+
A15	GND	B15	TX-
A16	RX+	B16	GND
A17	RX-	B17	PCIECLKRQ
A18	GND	B18	GND

PCIe 3			
Pin	Pin Assignment	Pin	Pin Assignment
A1	GND	B1	+12V
A2	+12V	B2	+12V
A3	+12V	B3	+12V
A4	GND	B4	GND
A5	USB+	B5	SMB_CLK
A6	USB-	B6	SMB_DATA
A7	+5V	B7	GND
A8	+5V	B8	+3V3
A9	+3V3	B9	NC
A10	+3V3	B10	+3V3DU
A11	RESET	B11	PCIE_WAKE
A12	GND	B12	NC
A13	CLK+	B13	GND
A14	CLK-	B14	TX+
A15	GND	B15	TX-
A16	RX+	B16	GND
A17	RX-	B17	PCIECLKRQ
A18	GND	B18	GND

Battery

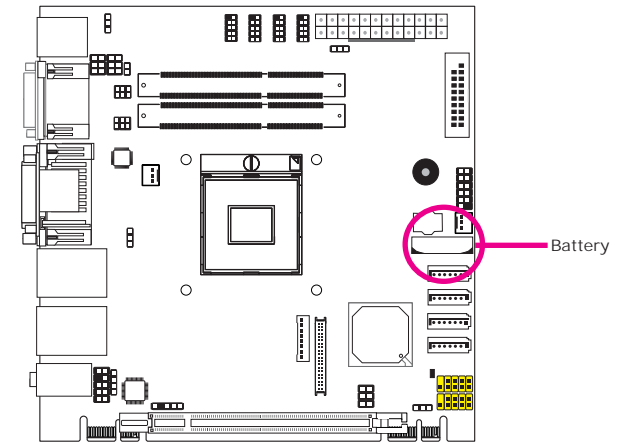

The lithium ion battery powers the real-time clock and CMOS memory. It is an auxiliary source of power when the main power is shut off.

Safety Measures

- Danger of explosion if battery incorrectly replaced.
- Replace only with the same or equivalent type recommend by the manufacturer.
- Dispose of used batteries according to local ordinance.

Chapter 6 - Mounting Options

Wall Mount

There are 2 types of wall mount brackets:

- Type A



- Type B



Type A wall mount kit include:

- 2 type A wall mount brackets



1. If the mounting screw has been previously attached to the top cover of the system, please remove them first.



2. At the sides of the system, use the mounting screws removed in step 1 to secure the wall mount brackets on each side of the system.

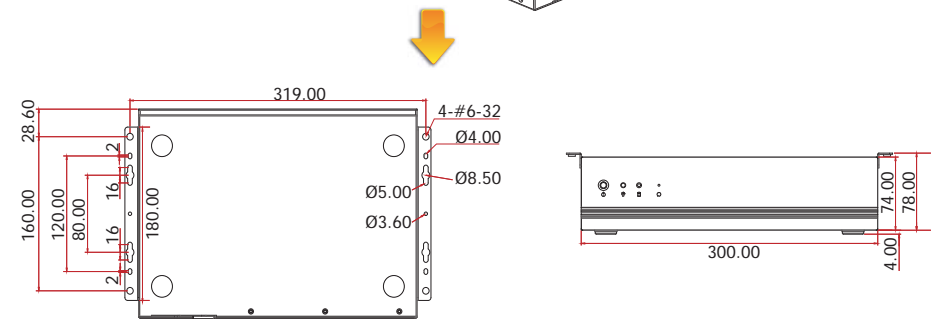
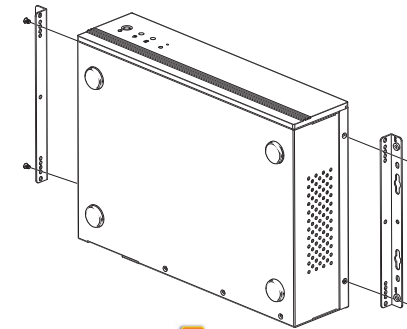
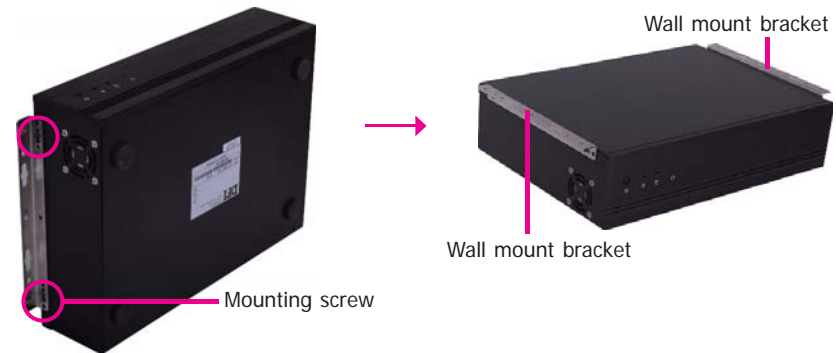

- Type B wall mount kit include:
- 2 type B wall mount brackets
 - Bracket screws



1. The 4 mounting holes on the sides of the system are used to mount the type B wall mount bracket.

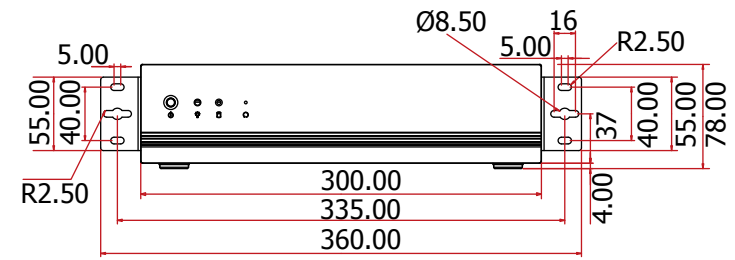
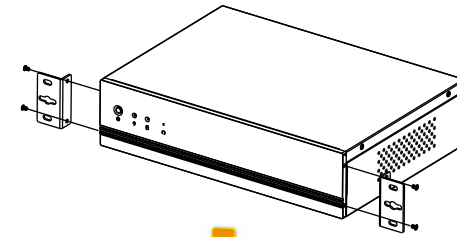
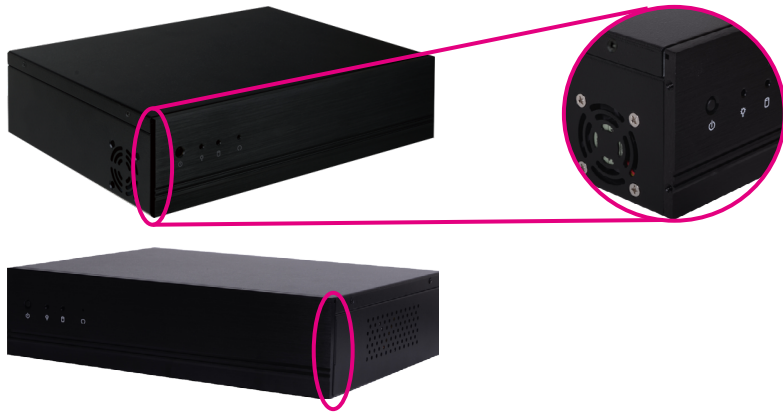

2. Use the provided mounting screws to secure the type B wall mount brackets on each side of the system.

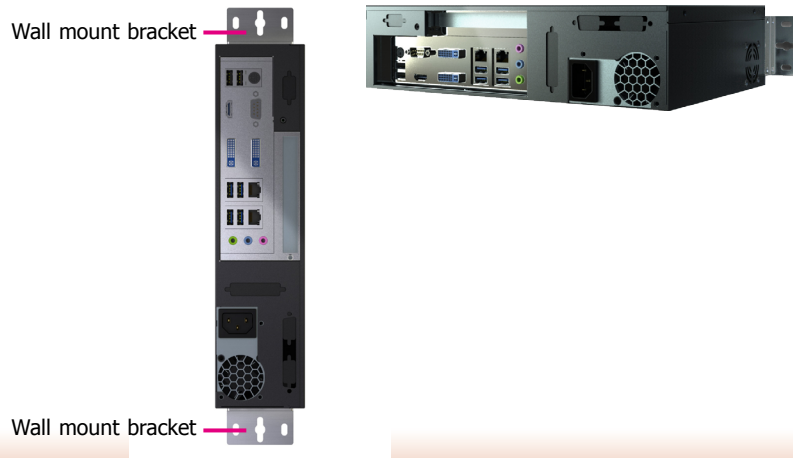

Chapter 7 - BIOS Setup

Overview

The BIOS is a program that takes care of the basic level of communication between the CPU and peripherals. It contains codes for various advanced features found in this system board. The BIOS allows you to configure the system and save the configuration in a battery-backed CMOS so that the data retains even when the power is off. In general, the information stored in the CMOS RAM of the EEPROM will stay unchanged unless a configuration change has been made such as a hard drive replaced or a device added.

It is possible that the CMOS battery will fail causing CMOS data loss. If this happens, you need to install a new CMOS battery and reconfigure the BIOS settings.



Note:

The BIOS is constantly updated to improve the performance of the system board; therefore the BIOS screens in this chapter may not appear the same as the actual one. These screens are for reference purpose only.

Default Configuration

Most of the configuration settings are either predefined according to the Load Optimal Defaults settings which are stored in the BIOS or are automatically detected and configured without requiring any actions. There are a few settings that you may need to change depending on your system configuration.

Entering the BIOS Setup Utility

The BIOS Setup Utility can only be operated from the keyboard and all commands are keyboard commands. The commands are available at the right side of each setup screen.

The BIOS Setup Utility does not require an operating system to run. After you power up the system, the BIOS message appears on the screen and the memory count begins. After the memory test, the message "Press DEL to run setup" will appear on the screen. If the message disappears before you respond, restart the system or press the "Reset" button. You may also restart the system by pressing the <Ctrl> <Alt> and keys simultaneously.

Legends

Keys	Function
Right and Left arrows	Moves the highlight left or right to select a menu.
Up and Down arrows	Moves the highlight up or down between submenu or fields.
<Esc>	Exit to the BIOS Setup Utility.
+ (plus key)	Scrolls forward through the values or options of the highlighted field.
- (minus key)	Scrolls backward through the values or options of the highlighted field.
Tab	Select a field.
<F1>	Displays General Help
<F4>	Saves and exits the Setup program.
<Enter>	Press <Enter> to enter the highlighted submenu.

Scroll Bar

When a scroll bar appears to the right of the setup screen, it indicates that there are more available fields not shown on the screen. Use the up and down arrow keys to scroll through all the available fields.

Submenu

When "►" appears on the left of a particular field, it indicates that a submenu which contains additional options are available for that field. To display the submenu, move the highlight to that field and press <Enter>.

ACPI Power Management Configuration

This section is used to configure the ACPI Power Management.

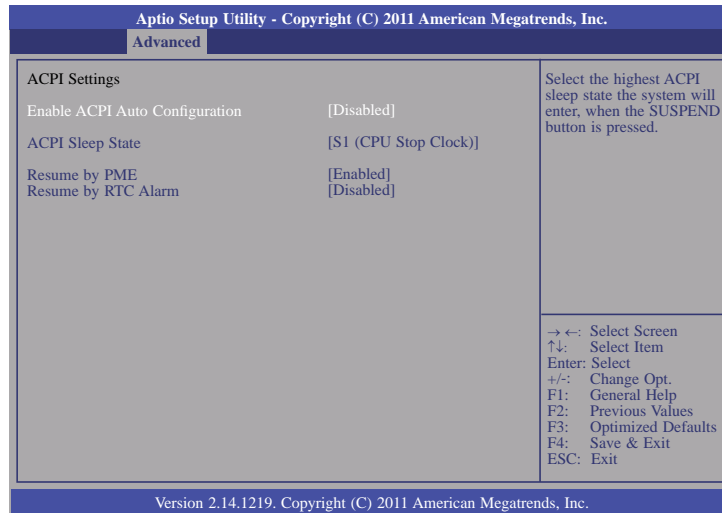

Enable ACPI Auto Configuration

Enable or disable the ACPI Auto Configuration.

ACPI Sleep State

Selects the highest ACPI sleep state the system will enter when the Suspend button is pressed.

S1(CPU Stop Clock) Enables the Power On Suspend function.

S3(Suspend to RAM) Enables the Suspend to RAM function.

Resume by PME

Enable this field to use the PME signal to wake up the system.

Resume by RTC Alarm

When Enabled, the system uses the RTC to generate a wakeup event.

PC Health Status

This section displays the SIO hardware health monitor.

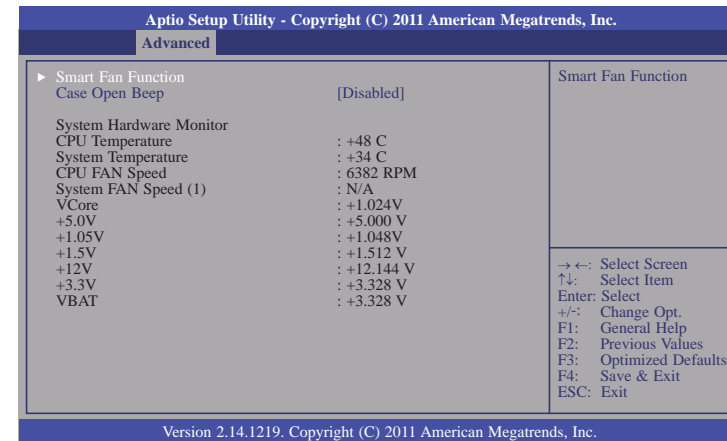

Smart Fan Function

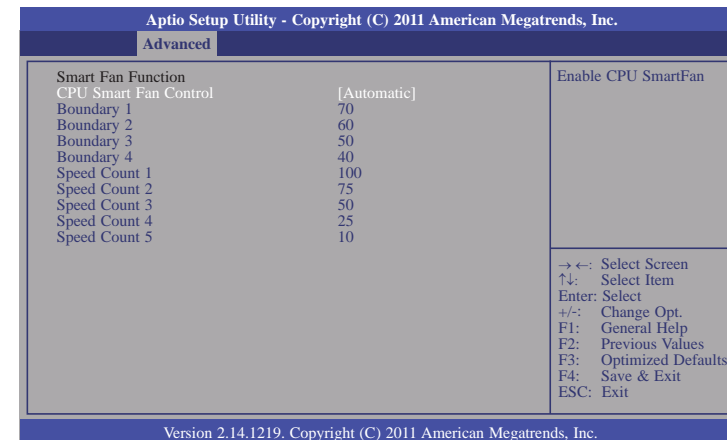

CPU Smart Fan Control

When this feature is set to Automatic, the CPU's fan speed will rotate according to the CPU's temperature. The higher the temperature, the faster the speed of rotation.

Boundary 1 to Boundary 4

The range is from 0-127.

Speed Count 1 to Speed Count 5

The range is from 1-100.

Case Open Beep

Set this field to Enabled to allow the system to alert you of a chassis intrusion event.

CPU Configuration

This section is used to configure the CPU. It will also display the detected CPU information.

Aptio Setup Utility - Copyright (C) 2011 American Megatrends, Inc.		
Advanced		
CPU Configuration		Enabled for Windows XP and Linux (OS optimized for Hyper-Threading Technology) and Disabled for other OS (OS not optimized for Hyper-Threading Technology). When Disabled only one thread per enabled core is enabled.
Intel(R) Core(TM) i7-2710QE CPU @ 2.10GHz		
CPU Signature	206a7	→ ←: Select Screen ↑ ↓: Select Item Enter: Select +/-: Change Opt. F1: General Help F2: Previous Values F3: Optimized Defaults F4: Save & Exit ESC: Exit
Microcode Patch	25	
Max CPU Speed	2100 MHz	
Min CPU Speed	800 MHz	
CPU Speed	2100 MHz	
Processor Cores	4	
Intel HT Technology	Supported	
Intel VT-x Technology	Supported	
Intel SMX Technology	Supported	
64-bit	Supported	
L1 Data Cache	32 kB x 4	
L1 Code Cache	32 kB x 4	
L2 Cache	265 kB x 4	
L3 Cache	6144 kB	
Hyper-threading	[Enabled]	
Limit CPUID Maximum	[Disabled]	
Intel Virtualization Technology	[Disabled]	

Hyper-threading

Enable this field for Windows XP and Linux which are optimized for Hyper-Threading technology. Select disabled for other OSes not optimized for Hyper-Threading technology. When disabled, only one thread per enabled core is enabled.

Limit CPUID Maximum

The CPUID instruction of some newer CPUs will return a value greater than 3. The default is Disabled because this problem does not exist in the Windows series operating systems. If you are using an operating system other than Windows, this problem may occur. To avoid this problem, enable this field to limit the return value to 3 or less than 3.

Intel Virtualization Technology

When this field is set to Enabled, the VMM can utilize the additional hardware capabilities provided by Vanderpool Technology.

SATA Configuration

This section is used to configure SATA functions.

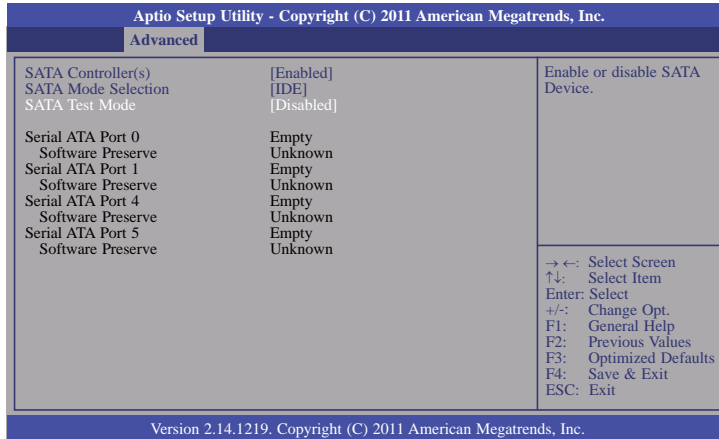

SATA Controller(s)

This field is used to enable or disable the Serial ATA channels.

SATA Mode Selection

IDE Mode

This option configures the Serial ATA drives as Parallel ATA storage devices.

AHCI Mode

This option allows the Serial ATA devices to use AHCI (Advanced Host Controller Interface).

RAID Mode

This option allows you to create RAID or Intel Matrix Storage configuration on Serial ATA devices.

SATA Test Mode

This field is used to enable or disable the Serial ATA test mode.

If AHCI or RAID is selected in the SATA Mode field, it will display the following information:

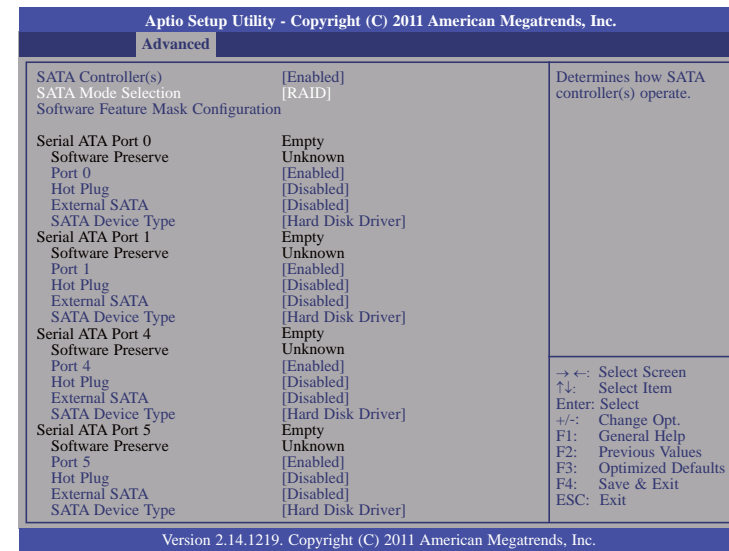

Serial ATA Port 0 to Serial ATA Port 5

These fields are used to configure the connected SATA devices.

Software Feature Mask Configuration

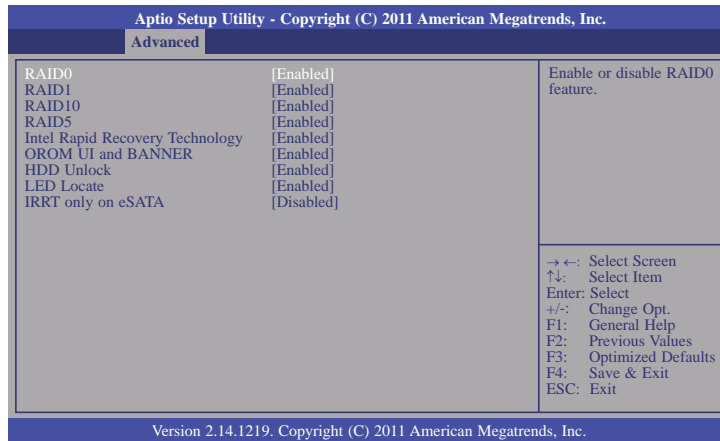

RAID0 to RAID5

Enables or disables RAID0 to RAID5 feature.

Intel Rapid Recovery Technology

Enables or disables Intel Rapid Recovery Technology.

OROM UI and BANNER

When enabled, the OROM UI is shown. When disabled, no OROM banner or information will be displayed if all disks and RAID volumes are Normal.

HDD Unlock

When enabled, it indicates that the HDD password unlock in the OS is enabled.

LED Locate

When enabled, it indicates that the LED/SGPIO hardware is attached and ping to locate feature is enabled on the OS.

IRRT only on eSATA

When enabled, only IRRT volumes can span internal and eSATA drives. When disabled, any RAID volume can span internal and eSATA drives.

Intel TXT (LT) Configuration

This section is used to configure the Intel Trusted Execution technology.

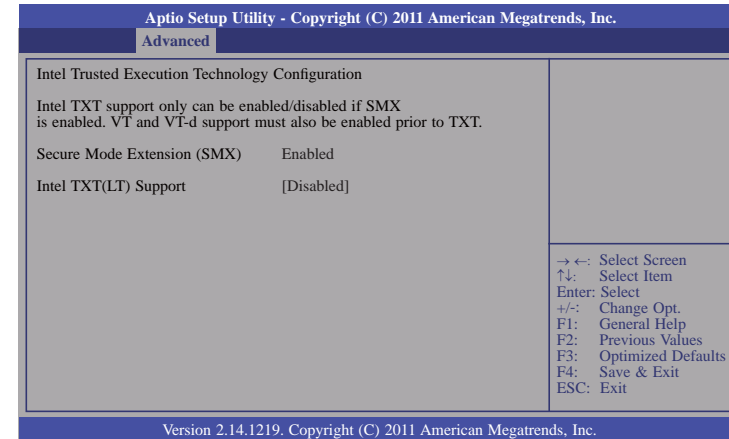

Secure Mode Extensions (SMX)

The options are Enabled and Disabled.

Intel TXT(LT) Support

The options are Enabled and Disabled.

PCH-FW Configuration

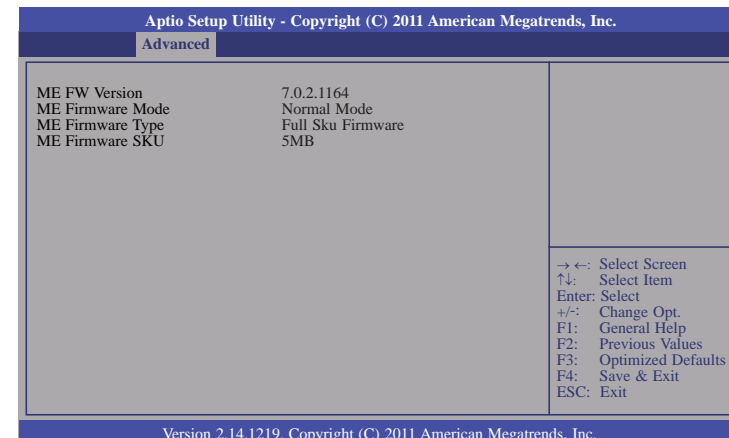

Anti-Theft Configuration

This section is used to disable the PC at the hardware level in the event of loss or theft.

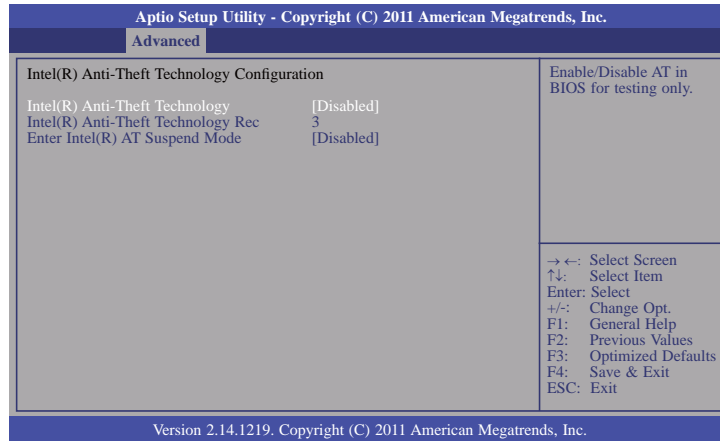

Intel(R) Anti-Theft Technology

The options are Enabled and Disabled.

Enter AT Suspend Mode

The options are Enabled and Disabled.

AMT Configuration

This section configures the parameters of Active Management Technology.

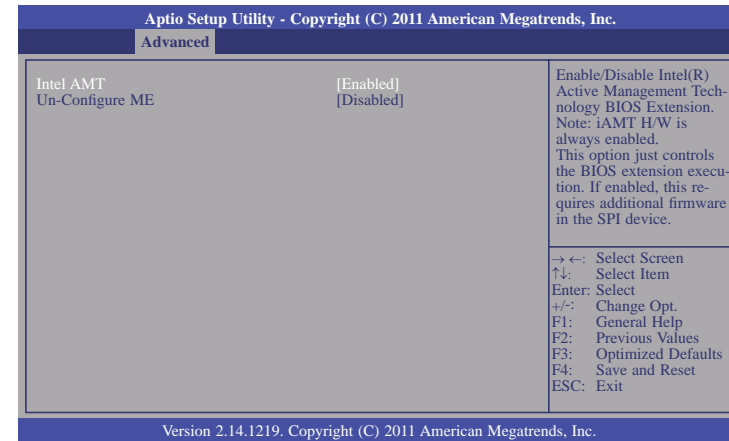

Intel AMT

Enables or disables the AMT function.

Un-Configure ME

Selects Enabled to un-configure the ME function without a password.

USB Configuration

This section is used to configure USB.

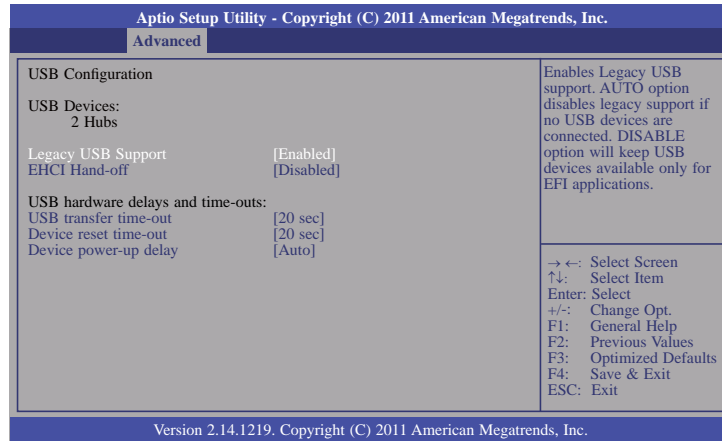

Legacy USB Support

Enabled

Enables legacy USB.

Auto

Disables support for legacy when no USB devices are connected.

Disabled

Keeps USB devices available only for EFI applications.

EHCI Hand-off

This is a workaround for OSes that does not support EHCI hand-off. The EHCI ownership change should be claimed by the EHCI driver.

USB transfer time-out

The time-out value for Bulk and Interrupt transfers.

Device reset time-out

Selects the USB mass storage device start unit command timeout.

Device power-up delay

Maximum time the device will take before it properly reports itself to the Host Controller. "Auto" uses default value: for a Root port it is 100 ms, for a Hub port the delay is taken from Hub descriptor.

F71879 Super IO Configuration

This section is used to configure the I/O functions supported by the onboard Super I/O chip.

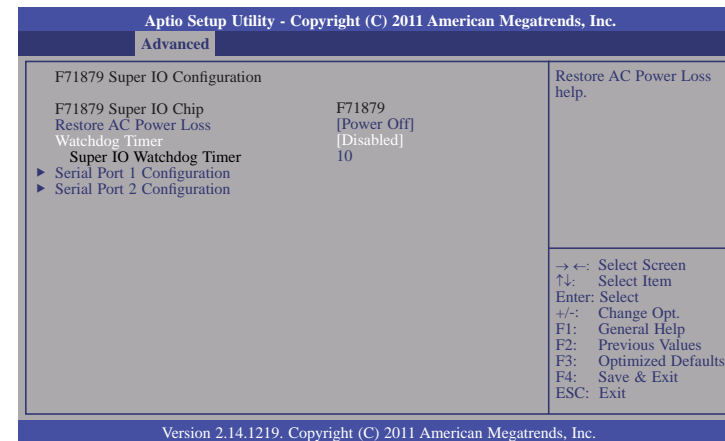

Restore AC Power Loss

Off

When power returns after an AC power failure, the system's power is off. You must press the Power button to power-on the system.

On

When power returns after an AC power failure, the system will automatically power-on.

Last State

When power returns after an AC power failure, the system will return to the state where you left off before power failure occurs. If the system's power is off when AC power failure occurs, it will remain off when power returns. If the system's power is on when AC power failure occurs, the system will power-on when power returns.

Watchdog Timer

Enable or disable Super IO Watchdog Timer.

Serial Port 1 Configuration to Serial Port 2 Configuration

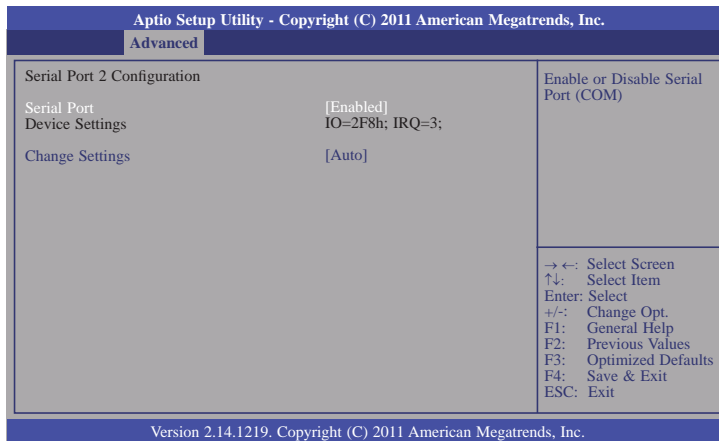
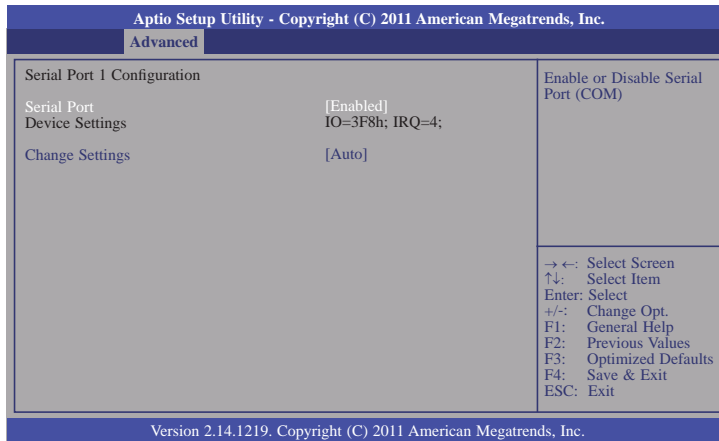

Serial Port

Enables or disables the serial port.

Change Settings

Selects the IO/IRQ setting of the I/O device.

Second Super IO Configuration

This section is used to configure the serial port functions.

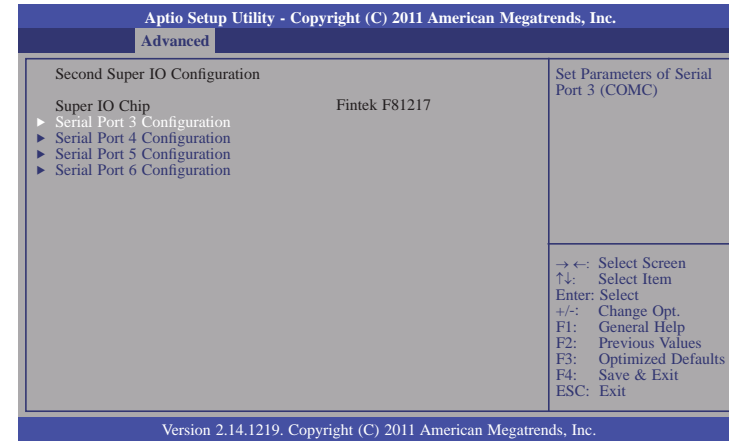

Serial Port 3 Configuration to Serial Port 6 Configuration

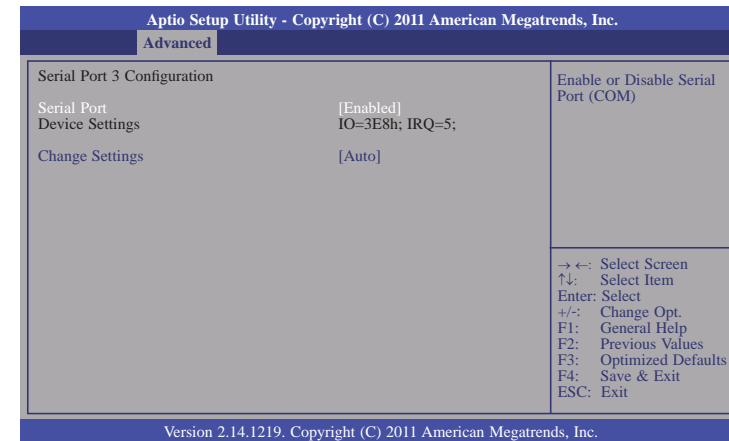

Serial Port

Enables or disables the serial port.

Change Settings

Selects the IO/IRQ setting of the I/O device.

Network Stack

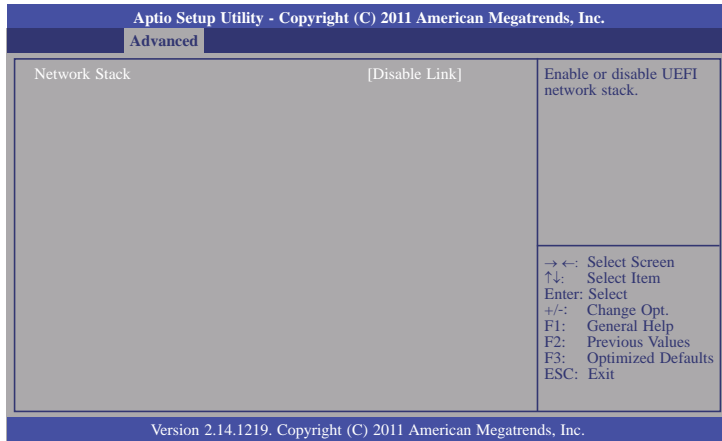

Network Stack

Enables or disables UEFI network stack.

Onboard ATA Controller Configuration

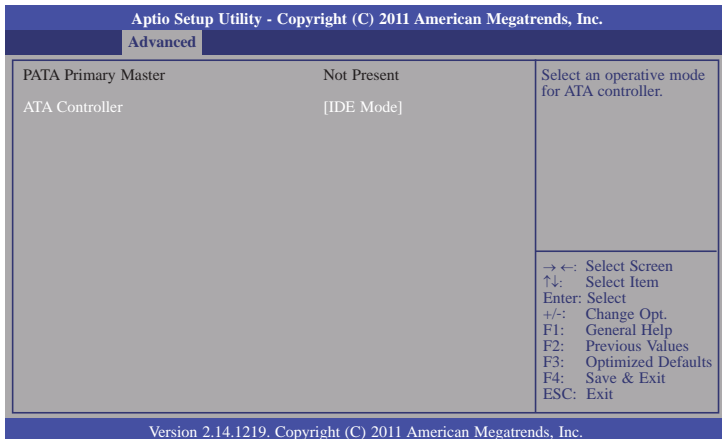

ATA Controller

Select between disable or IDE Mode for an operative mode for ATA controller.

Sandybridge PPM Configuration

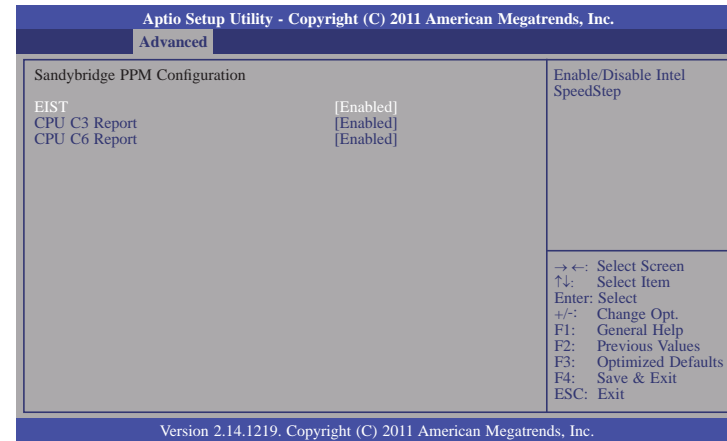

EIST

This field is used to enable or disable the Intel Enhanced SpeedStep Technology.

CPU C3 Report and CPU C6 Report

Enables or disables CPU C3 (ACPI C2) and C6 report to OS.

Chipset

Configures relevant chipset functions.

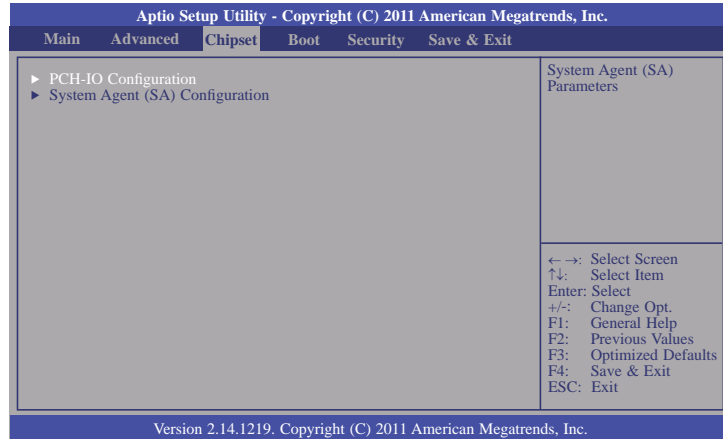

System Agent (SA) Configuration

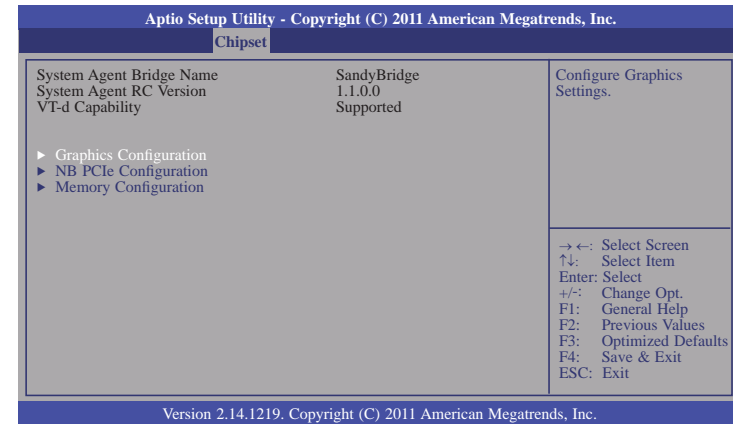

Graphics Configuration

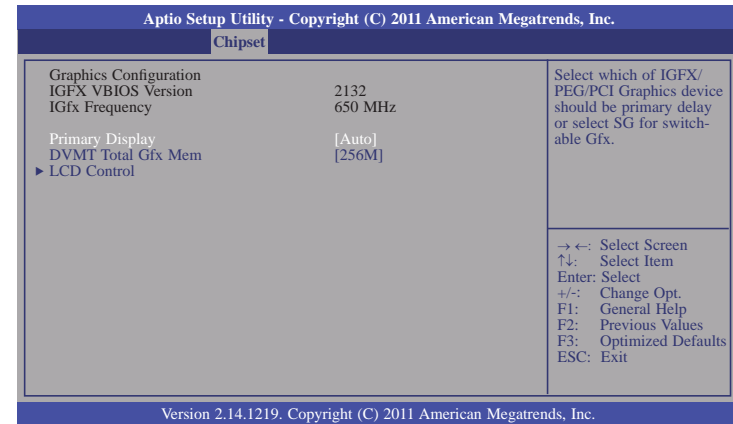

Primary Display

- Auto When the system boots, it will auto detects the display device.
- IGFX When the system boots, it will first initialize the onboard VGA.
- PEG When the system boots, it will first initialize the PCI Express x16 graphics card.

DVM T Total Gfx Mem

This field is used to select the graphics memory size used by DVM T mode.

DVMT Total Gfx Mem

This field is used to select the graphics memory size used by DVMT mode.

LCD Control

Aptio Setup Utility - Copyright (C) 2011 American Megatrends, Inc.		
Chipset		
LCD Control		Select the Video Device which will be activated during POST. This has no effect if external graphics present. Secondary boot display selection will appear based on your selection. VGA modes will be supported only on primary display.
Primary IGFX Boot Display	[CRT]	
Secondary IGFX Boot Display	[Disabled]	
LCD Panel Type	[VBIOS Default]	
		→ ←: Select Screen ↑ ↓: Select Item Enter: Select +/-: Change Opt. F1: General Help F2: Previous Values F3: Optimized Defaults F4: Save & Exit ESC: Exit
Version 2.14.1214. Copyright (C) 2011 American Megatrends, Inc.		

Primary IGFX Boot Display and Secondary IGFX Boot Display

The options are Disabled, CRT, EFP, LFP, EFP3 and EFP2.

LCD Panel Type

This field is used to select the type of LCD panel used by the internal graphics device.

NB PCIe Configuration

Aptio Setup Utility - Copyright (C) 2011 American Megatrends, Inc.		
Chipset		
NB PCIe Configuration	Not Present	Configure PEG0 B0: D1: F0 Gen1-Gen2
PEG0		
Display Present	[PCIe x16]	
		→ ←: Select Screen ↑ ↓: Select Item Enter: Select +/-: Change Opt. F1: General Help F2: Previous Values F3: Optimized Defaults F4: Save & Exit ESC: Exit
Version 2.14.1219. Copyright (C) 2011 American Megatrends, Inc.		

Display Present

Selects the display mode. The options are PCIe x16 and SDVO/HDMI/DP.

Memory Configuration

Aptio Setup Utility - Copyright (C) 2011 American Megatrends, Inc.		
Chipset		
Memory Information		
Memory RC Version	1.0.0.1	
Memory Frequency	1333 Mhz	
Total Memory	4096 MB (DDR3)	
DIMM#0	2048 MB (DDR3)	
DIMM#2	2048 MB (DDR3)	
CAS Latency (tCL)	9	
Minimum delay time		
CAS to RAS (tRCDmin)	9	
Row Precharge (tRPmin)	9	
Active to Precharge (tRASmin)	24	
		→ ←: Select Screen ↑↓: Select Item Enter: Select +/-: Change Opt. F1: General Help F2: Previous Values F3: Optimized Defaults F4: Save & Exit ESC: Exit
Version 2.14.1219. Copyright (C) 2011 American Megatrends, Inc.		

PCH-IO Configuration

Aptio Setup Utility - Copyright (C) 2011 American Megatrends, Inc.		
Chipset		
Intel PCH RC Version	1.1.0.0	PCI Express Configuration settings.
Intel PCH SKU Name	QM67	
Intel PCH Rev ID	05/B3	
▶ PCI Express Configuration		
▶ USB Configuration		
PCH LAN Controller	[Enabled]	
Wake on LAN	[Enabled]	
After G3	[Power on]	
		→ ←: Select Screen ↑↓: Select Item Enter: Select +/-: Change Opt. F1: General Help F2: Previous Values F3: Optimized Defaults ESC: Exit
Version 2.14.1219. Copyright (C) 2011 American Megatrends, Inc.		

PCH LAN Controller

Enables or disables the PCH LAN controller.

Wake on LAN

Set this field to Enabled to wake up the system via the onboard LAN or via a LAN card that supports the remote wake up function.

After G3

Power Off / WOL

Power-on the system via WOL after G3.

Power On

Power-on the system after G3.

USB Configuration

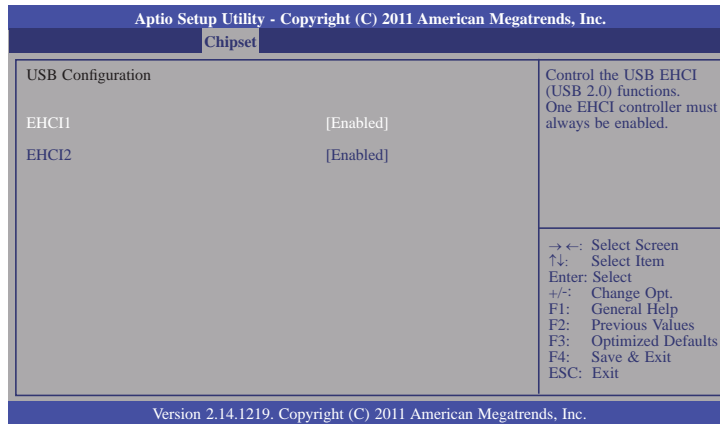

EHCI1 and EHCI2

These fields are used to enable or disable USB 2.0.

PCI Express Configuration

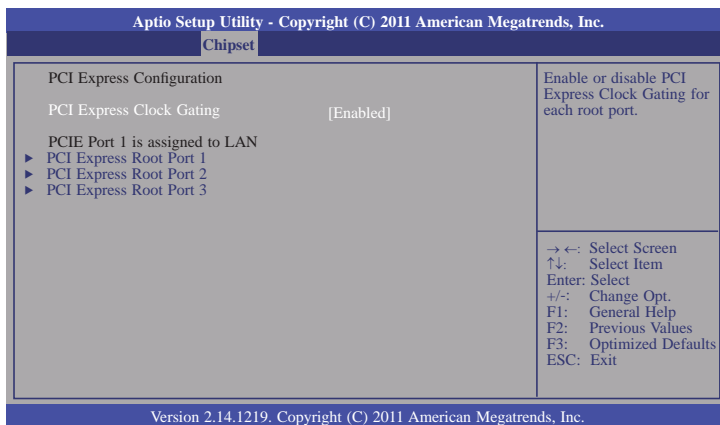

PCI Express Clock Gating

Enables or disables PCI Express Clock Gating for each root port.

PCI Express Root Port 1 to PCI Express Root Port 3

Controls the PCI Express Root Port.

Boot

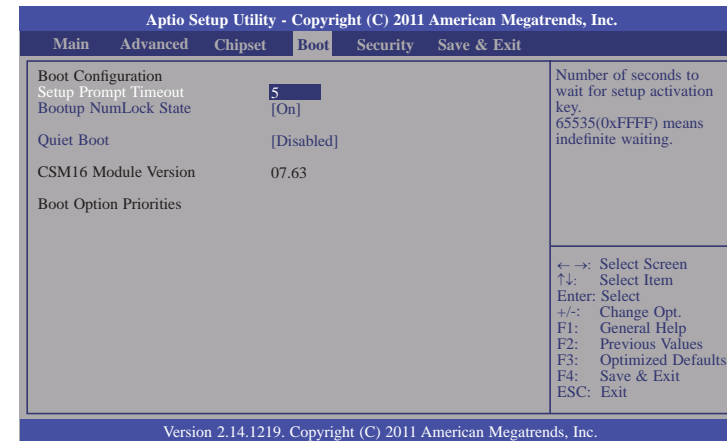

Setup Prompt Timeout

Selects the number of seconds to wait for the setup activation key. 65535(0xFFFF) denotes indefinite waiting.

Bootup NumLock State

This allows you to determine the default state of the numeric keypad. By default, the system boots up with NumLock on wherein the function of the numeric keypad is the number keys. When set to Off, the function of the numeric keypad is the arrow keys.

Quiet Boot

Enables or disables the quiet boot function.

Security

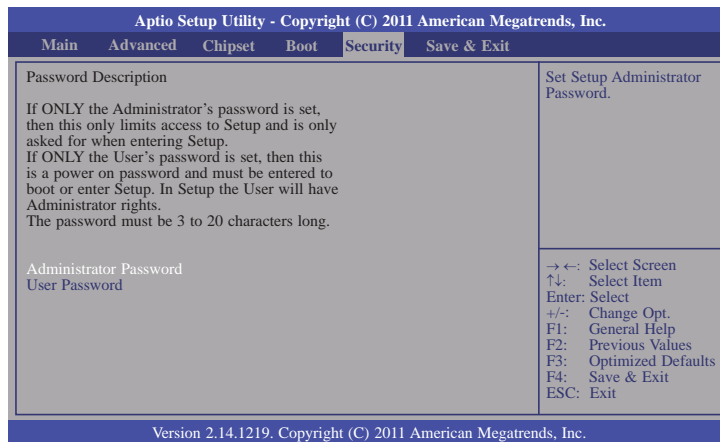

Administrator Password

Sets the administrator password.

User Password

Sets the user password.

Save & Exit

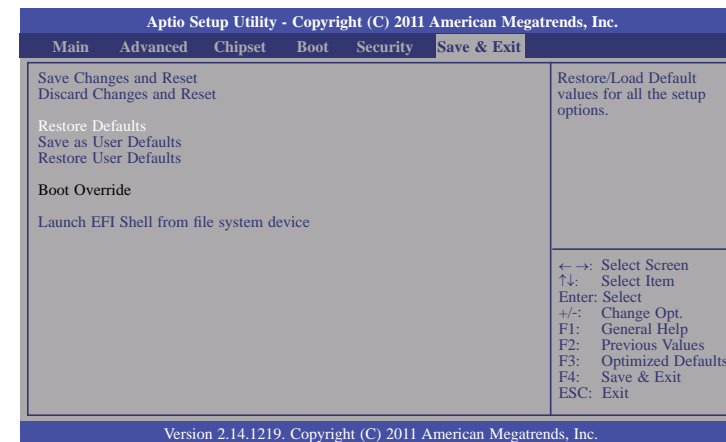

Save Changes and Reset

To save the changes, select this field and then press <Enter>. A dialog box will appear. Select Yes to reset the system after saving all changes made.

Discard Changes and Reset

To discard the changes, select this field and then press <Enter>. A dialog box will appear. Select Yes to reset the system setup without saving any changes.

Restore Defaults

To restore and load the optimized default values, select this field and then press <Enter>. A dialog box will appear. Select Yes to restore the default values of all the setup options.

Save as User Defaults

To save changes done so far as user default, select this field and then press <Enter>. A dialog box will appear. Select Yes to save values as user default.

Restore User Defaults

To restore user default to all the setup options, select this field and then press <Enter>. A dialog box will appear. Select Yes to restore user default.

Updating the BIOS

To update the BIOS, you will need the new BIOS file and a flash utility, AFUDOS.EXE. Please contact technical support or your sales representative for the files.

To execute the utility, type:

```
A:> AFUDOS BIOS_File_Name /b /p /n
```

then press <Enter>.

```
C:\AFU\AFUDOS>afudos filename /B /P /N
+-----+
|               AMI Firmware Update Utility(APTIO) v2.25               |
|               Copyright (C)2008 American Megatrends Inc. All Rights Reserved.               |
+-----+
Reading file ..... done
Erasing flash ..... done
Writing flash ..... done
Verifying flash ..... done
Erasing BootBlock ..... done
Writing BootBlock ..... done
Verifying BootBlock ..... done

C:\AFU\AFUDOS>
```

Chapter 8 - Supported Software

Some devices of the system require drivers from hardware manufactures to operate properly. The system may come with a CD/DVD that contains drivers, utilities and software applications. Insert the CD into a CD-ROM drive. The auto-run screen (Mainboard Utility CD) will appear. If the "Autorun" does not automatically start, please go to the root directory of the CD and double-click "Setup".

If your product package does not include a CD/DVD, you can download the latest drivers from the DFI Download Center:

<http://www.dfi.com/DownloadCenter>

Once you are in the Download Center page, select your product or type the model name and click "Search" to find product-related resources such as documentation and drivers.

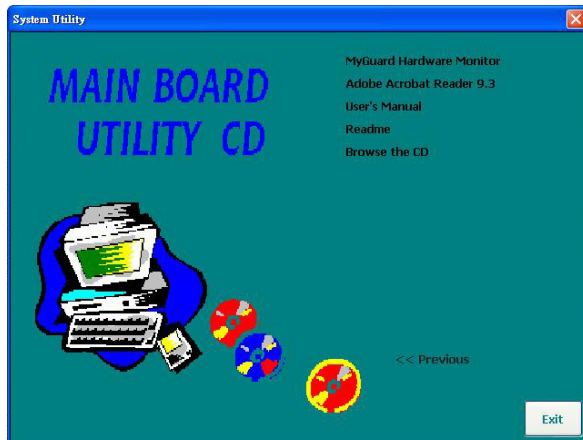

Microsoft .NET Framework 3.5 (for Windows XP only)



Note:

Before installing Microsoft .NET Framework 3.5, make sure you have updated your Windows XP operating system to Service Pack 3.

To install the driver, click "Microsoft .NET Framework 3.5" on the main menu.

1. Read the license agreement carefully.

Click "I have read and accept the terms of the License Agreement" then click Install.

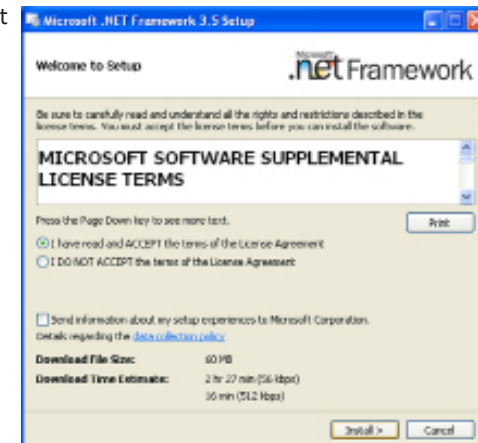

2. Setup is now installing the driver.

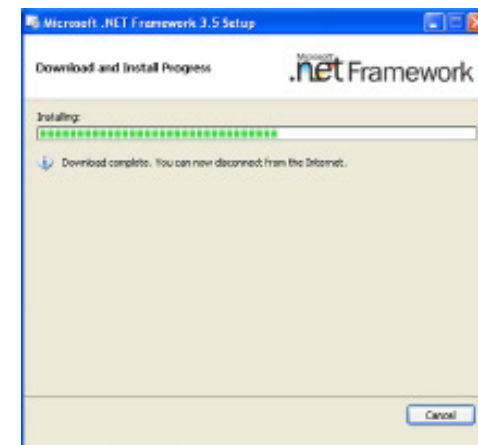

3. Click Exit.

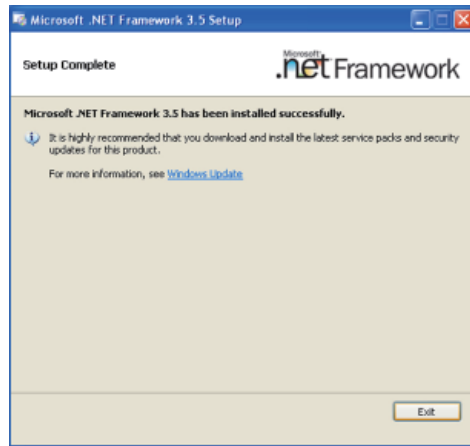

Microsoft DirectX 9.0C (for Windows XP only)

To install the utility, click "Microsoft DirectX 9.0C" on the main menu.

1. Click "I accept the agreement" then click Next.

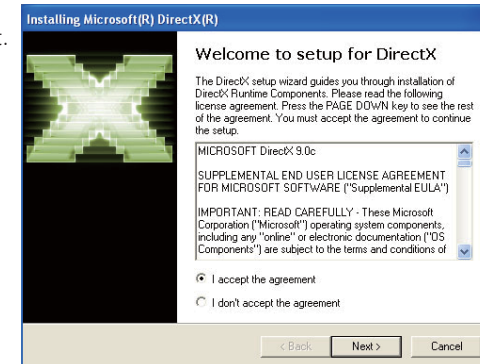

2. To start installation, click Next.

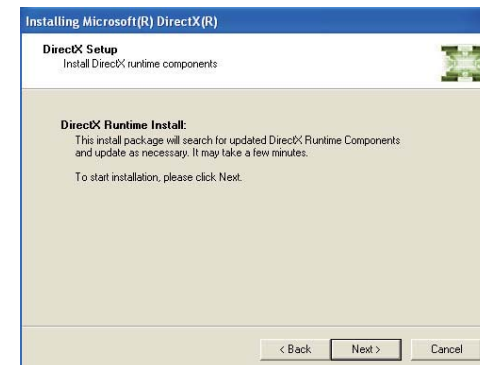

3. Click Finish. Reboot the system for DirectX to take effect.

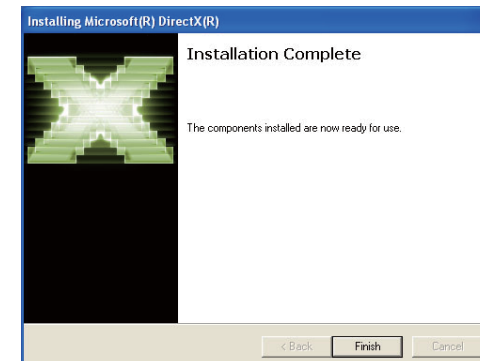

Intel Chipset Software Installation Utility

The Intel Chipset Software Installation Utility is used for updating Windows® INF files so that the Intel chipset can be recognized and configured properly in the system.

To install the utility, click “Intel Chipset Software Installation Utility” on the main menu.

1. Setup is ready to install the utility. Click Next.



2. Read the license agreement then click Yes.



3. Go through the readme document for more installation tips then click Next.



4. Click Finish to exit setup.



Intel Graphics Drivers (for Windows XP)

To install the driver, click "Intel Graphics Drivers" on the main menu.

1. Setup is ready to install the graphics driver. Click Next.



2. Read the license agreement then click Yes.



3. Go through the readme document for more installation tips then click Next.

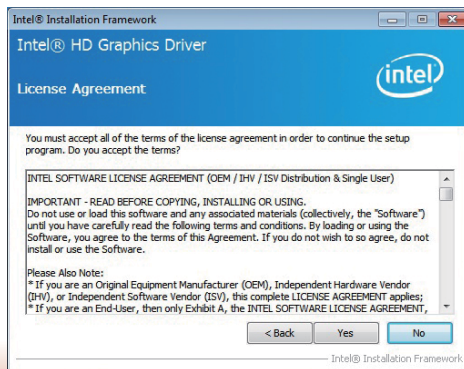

4. Setup is currently installing the driver. After installation has completed, click Next.

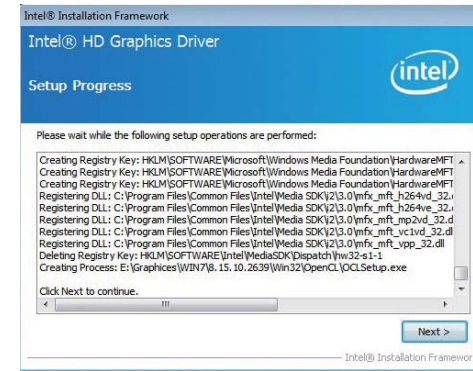

5. Click "Yes, I want to restart this computer now." then click Finish.

Restarting the system will allow the new software installation to take effect.

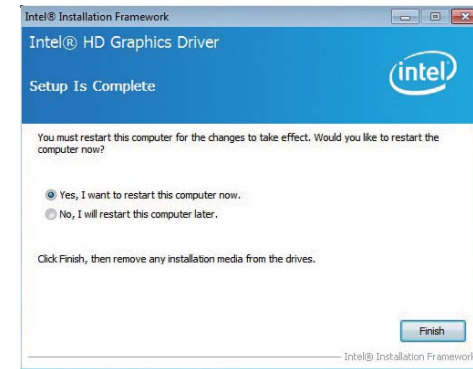

Intel Management Engine Drivers

To install the driver, click "Intel Management Engine Drivers" on the main menu.

1. Setup is ready to install the driver. Click Next.

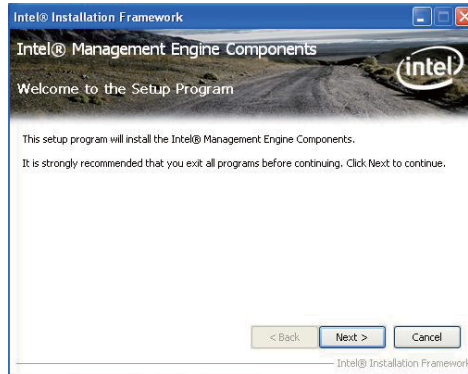

2. Read the license agreement then click Yes.



3. Go through the readme document for more installation tips then click Next.

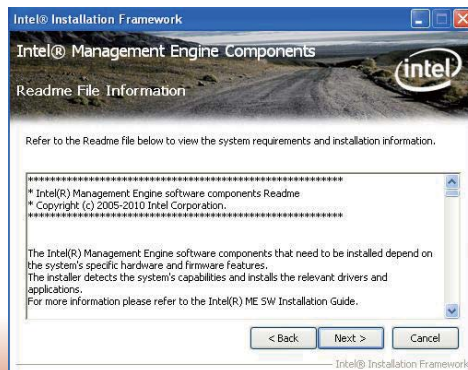

4. Setup is currently installing the driver. After installation has completed, click Next.

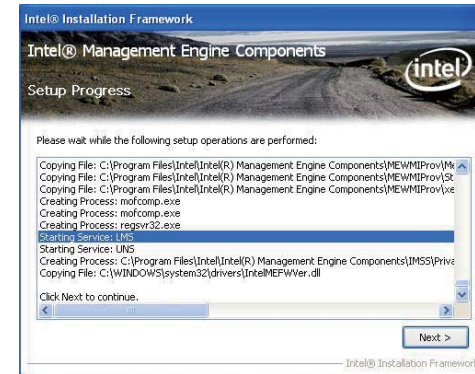

5. After completing installation, click Finish.

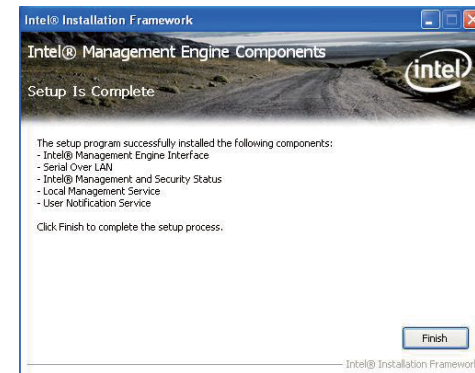

Intel Rapid Storage Drivers

To install the driver, click "Intel Rapid Storage Drivers" on the main menu.

1. Setup is ready to install the driver. Click Next.



2. Read the license agreement then click Yes.



3. Go through the readme document for more installation tips then click Next.



4. Setup is currently installing the driver. After installation has completed, click Next.

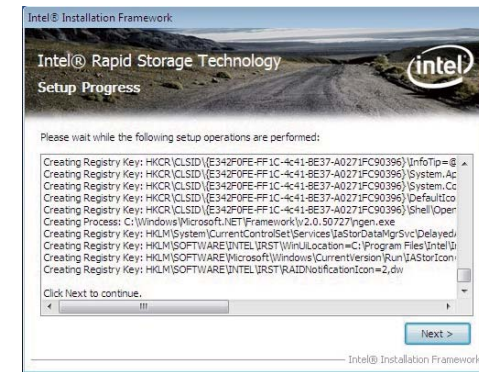

5. Click "Yes, I want to restart this computer now." then click Finish.

Restarting the system will allow the new software installation to take effect.

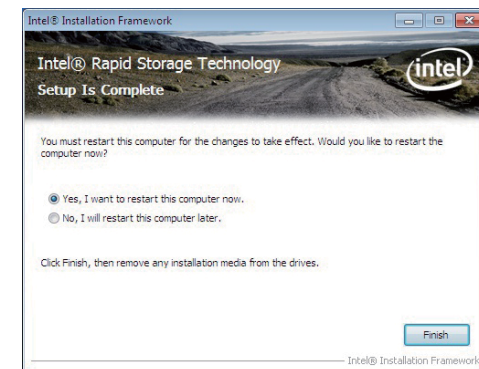

Audio Drivers

To install the driver, click “Audio Drivers” on the main menu.

1. Setup is now ready to install the audio driver. Click Next.
2. Follow the remainder of the steps on the screen; clicking “Next” each time you finish a step.

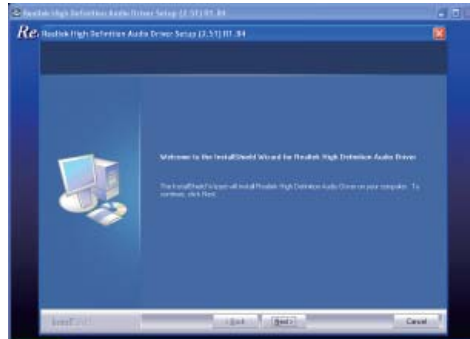

3. Click “Yes, I want to restart my computer now” then click Finish.

Restarting the system will allow the new software installation to take effect.

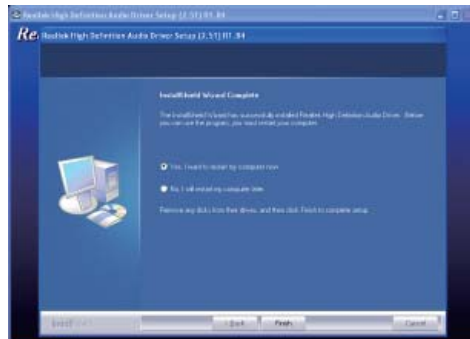

Realtek LAN Drivers

To install the driver, click “Realtek LAN Drivers” on the main menu.

1. Setup is ready to install the driver. Click Next.

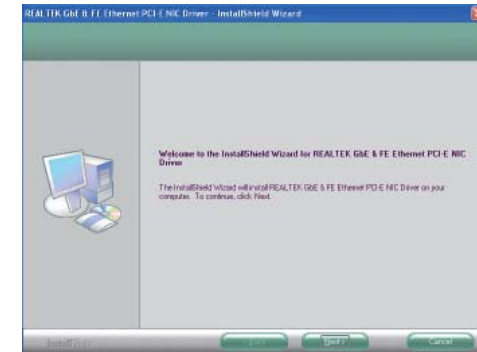

2. Click Install to begin the installation.

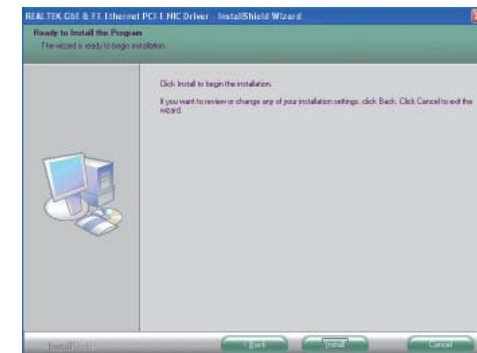

3. After completing installation, click Finish.

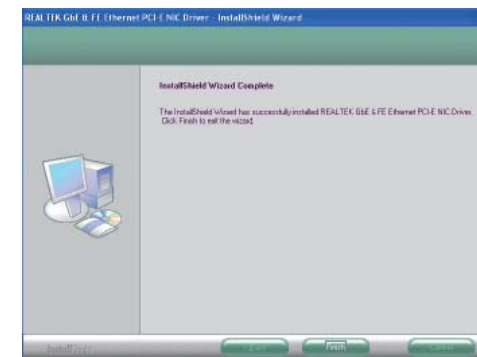

Intel LAN Drivers

To install the driver, click “Intel LAN Drivers” on the main menu.

1. Setup is ready to install the driver. Click Next.



2. Click “I accept the terms in the license agreement” then click “Next”.

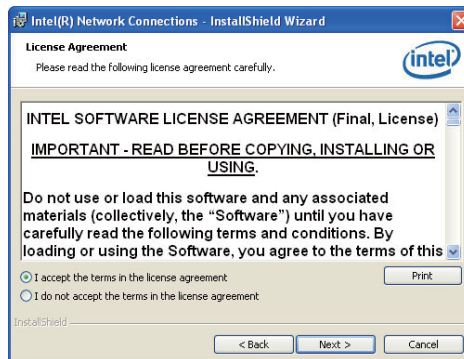

3. Select the program features you want installed then click Next.

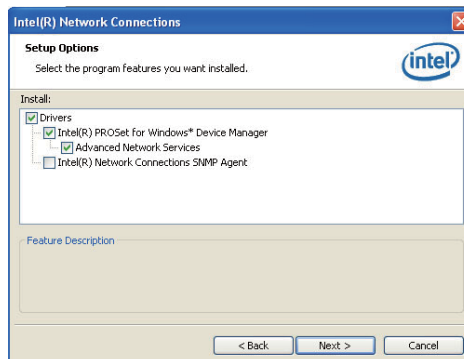

4. Click Install to begin the installation.

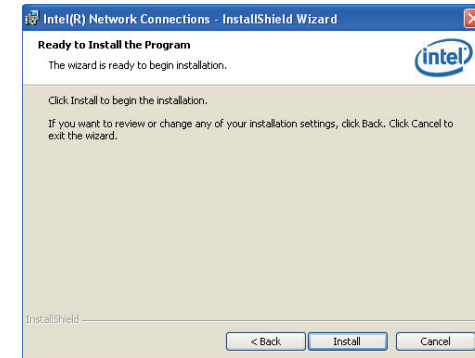

5. After completing installation, click Finish.

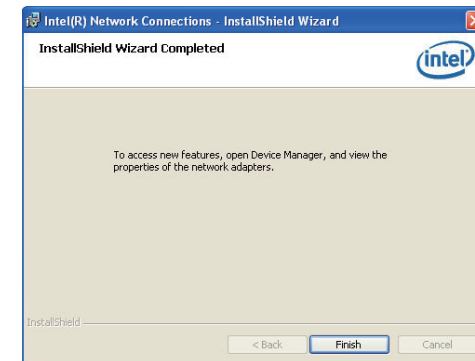

MyGuard Hardware Monitor

1. Locate for the MyGuard folder in the provided disc.
2. In the MyGuard folder, right-click on the "setup" file.
3. Select Run As Administrator.
4. Double-click Setup.

Important:
Perform steps 1-3 only when using Windows 7 or Windows Vista.

5. Setup is ready to install the utility. Click Next.

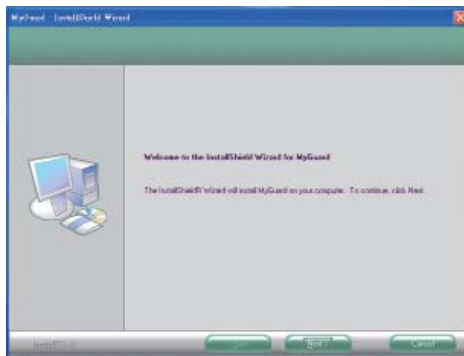
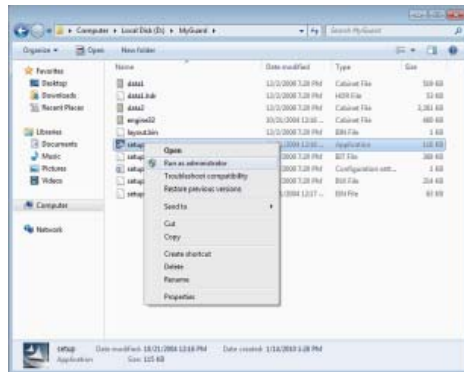

6. Click Install to begin installation.

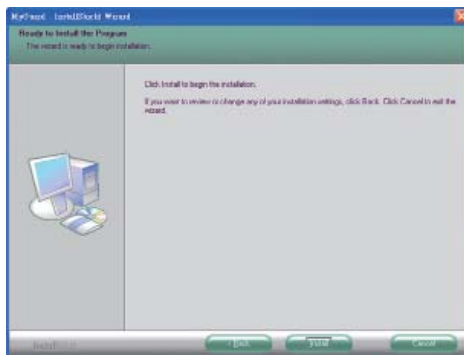

7. Setup is currently installing the utility.

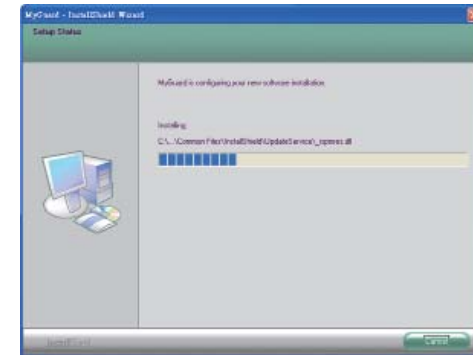

8. After completing installation, click Finish to exit setup.

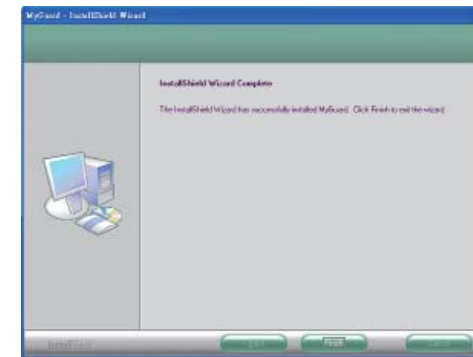

F6 Floppy Configuration Utility

This is used to create a floppy driver diskette needed when you install Windows® XP using the F6 installation method. This will allow you to install the operating system onto a hard drive when in AHCI mode.

1. Insert a blank floppy diskette.
2. Locate for the drivers in the CD then copy them to the floppy diskette. The CD includes drivers for both 32-bit and 64-bit operating systems. The path to the drivers are shown below.

32-bit
CD Drive:\AHCI_RAID\F6FLOPPY\f6flpy32

64-bit
CD Drive:\AHCI_RAID\F6FLOPPY\f6flpy64

Adobe Acrobat Reader 9.3

To install the reader, click “Adobe Acrobat Reader 9.3” on the main menu.

1. Click Next to install or click Change Destination Folder to select another folder.

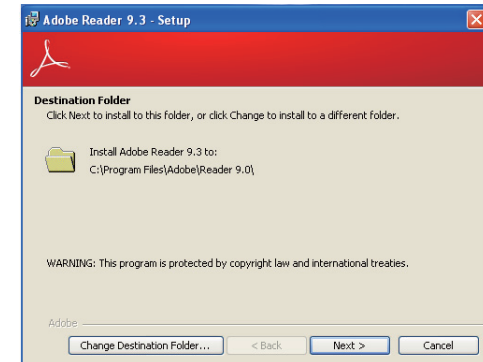

2. Click Install to begin installation.

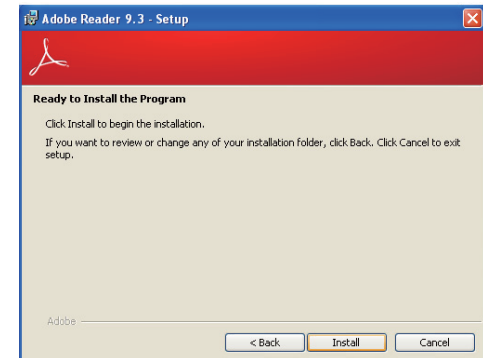

3. Click Finish to exit installation.

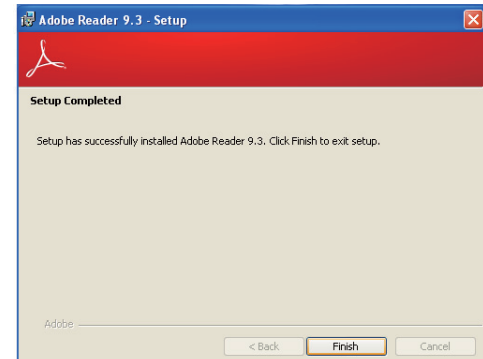

Chapter 9 - Raid

The system board allows configuring RAID on Serial ATA drives. It supports RAID 0, RAID 1, RAID 5 and RAID 10.

RAID Levels

RAID 0 (Striped Disk Array without Fault Tolerance)

RAID 0 uses two new identical hard disk drives to read and write data in parallel, interleaved stacks. Data is divided into stripes and each stripe is written alternately between two disk drives. This improves the I/O performance of the drives at different channel; however it is not fault tolerant. A failed disk will result in data loss in the disk array.

RAID 1 (Mirroring Disk Array with Fault Tolerance)

RAID 1 copies and maintains an identical image of the data from one drive to the other drive. If a drive fails to function, the disk array management software directs all applications to the other drive since it contains a complete copy of the drive's data. This enhances data protection and increases fault tolerance to the entire system. Use two new drives or an existing drive and a new drive but the size of the new drive must be the same or larger than the existing drive.

RAID 5

RAID 5 stripes data and parity information across hard drives. It is fault tolerant and provides better hard drive performance and more storage capacity.

RAID 10 (Mirroring and Striping)

RAID 10 is a combination of data striping and data mirroring providing the benefits of both RAID 0 and RAID 1. Use four new drives or an existing drive and three new drives for this configuration.

Settings

To enable the RAID function, the following settings are required.

1. Connect the Serial ATA drives.
2. Configure Serial ATA in the AMI BIOS.
3. Configure RAID in the RAID BIOS.
4. Install the RAID driver during OS installation.
5. Install the Intel Rapid Storage Drivers.

Step 1: Connect the Serial ATA Drives

Refer to chapter 2 for details on connecting the Serial ATA drives.



Important:

1. Make sure you have installed the Serial ATA drives and connected the data cables otherwise you won't be able to enter the RAID BIOS utility.
2. Treat the cables with extreme caution especially while creating RAID. A damaged cable will ruin the entire installation process and operating system. The system will not boot and you will lose all data in the hard drives. Please give special attention to this warning because there is no way of recovering back the data.

Step 2: Configure Serial ATA in the AMI BIOS

1. Power-on the system then press to enter the main menu of the AMI BIOS.
2. Configure Serial ATA in the appropriate fields.
3. Save the changes in the Save & Exit menu.
4. Reboot the system.

Step 3: Configure RAID in the RAID BIOS

When the system powers-up and all drives have been detected, the Intel RAID BIOS status message screen will appear. Press the <Ctrl> and <I> keys simultaneously to enter the utility. The utility allows you to build a RAID system on Serial ATA drives.

Step 4: Install the RAID Driver During OS Installation

The RAID driver must be installed during the Windows® XP or Windows® 2000 installation using the F6 installation method. This is required in order to install the operating system onto a hard drive or RAID volume when in RAID mode or onto a hard drive when in AHCI mode.

1. Start Windows Setup by booting from the installation CD.
2. Press <F6> when prompted in the status line with the 'Press F6 if you need to install a third party SCSI or RAID driver' message.
3. Press <S> to "Specify Additional Device".
4. At this point you will be prompted to insert a floppy disk containing the RAID driver. Insert the RAID driver diskette.
5. Locate for the drive where you inserted the diskette then select RAID or AHCI controller that corresponds to your BIOS setup. Press <Enter> to confirm.

You have successfully installed the driver. However you must continue installing the OS. Leave the floppy disk in the floppy drive until the system reboots itself because Windows setup will need to copy the files again from the floppy disk to the Windows installation folders. After Windows setup has copied these files again, remove the floppy diskette so that Windows setup can reboot as needed.

Step 5: Install the Intel Rapid Storage Drivers

The Intel Rapid Storage Drivers can be installed from within Windows. It allows RAID volume management (create, delete, migrate) from within the operating system. It will also display useful SATA device and RAID volume information. The user interface, tray icon service and monitor service allow you to monitor the current status of the RAID volume and/or SATA drives. It enables enhanced performance and power management for the storage subsystem.

1. Insert the provided CD into an optical drive.
2. Click "Intel Rapid Storage Technology for Raid/AHCI" on the main menu.
3. Setup is ready to install the utility. Click Next.

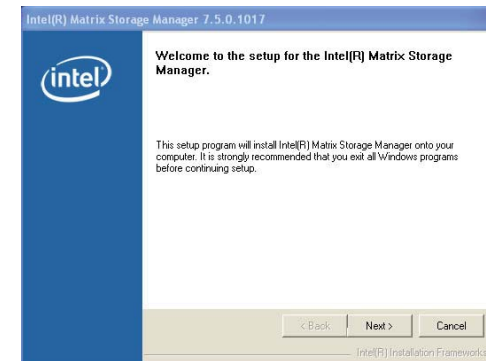

4. Read the warning carefully then click Next.



5. Read the license agreement then click Yes.



6. Go through the readme document to view system requirements and installation information then click Next.



7. Click "Yes, I want to restart my computer now" then click Finish.



Chapter 10 - Intel® AMT Settings

Overview

Intel Active Management Technology (Intel® AMT) combines hardware and software solution to provide maximum system defense and protection to networked systems.

The hardware and software information are stored in non-volatile memory. With its built-in manageability and latest security applications, Intel® AMT provides the following functions.

- Discover

Allows remote access and management of networked systems even while PCs are powered off; significantly reducing desk-side visits.

- Repair

Remotely repair systems after OS failures. Alerting and event logging help detect problems quickly to reduce downtime.

- Protect

Intel AMT's System Defense capability remotely updates all systems with the latest security software. It protects the network from threats at the source by proactively blocking incoming threats, reactively containing infected clients before they impact the network, and proactively alerting when critical software agents are removed.

Enable Intel® AMT in the AMI BIOS

1. Power-on the system then press to enter the main menu of the AMI BIOS.
2. In the **Advanced** menu, select **AMT Configuration**.

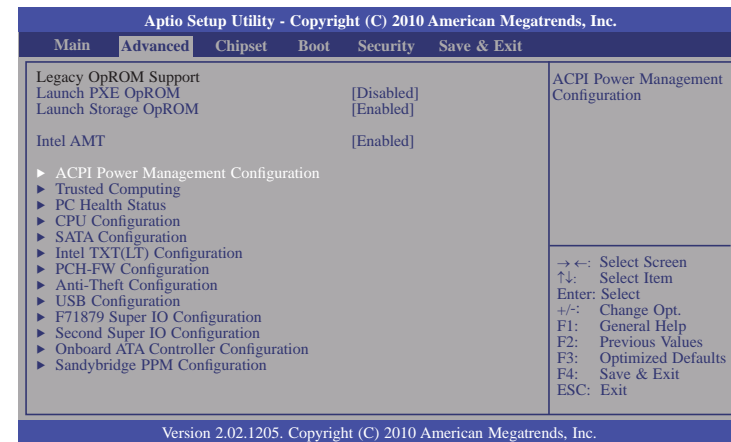

3. In the **Advanced** menu, select **Enable** in the **AMT** field.

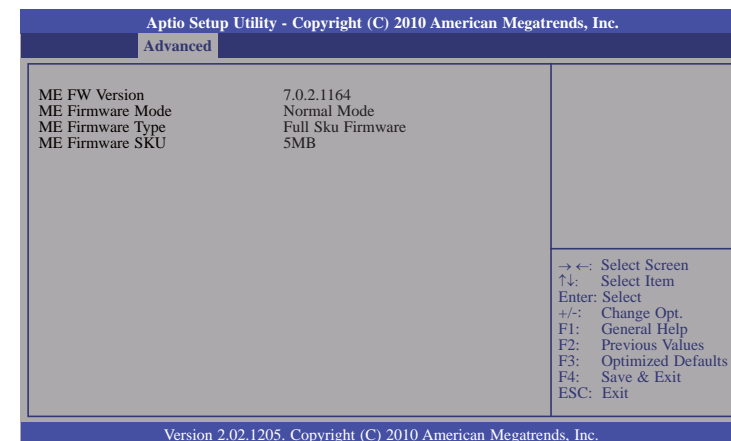

4. In the **Save & Exit** menu, select **Save Changes and Reset** then select **OK**.

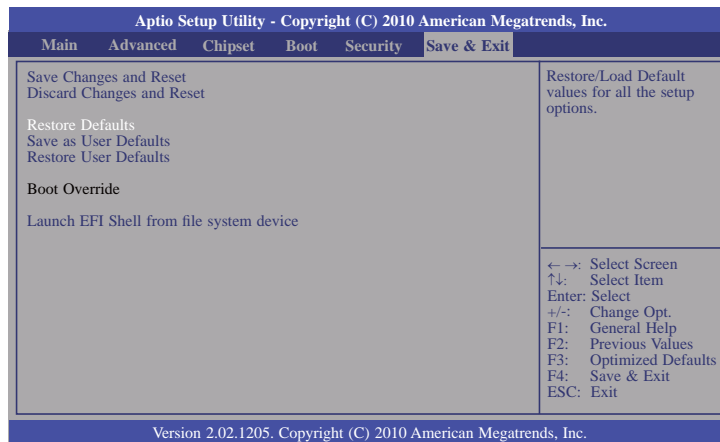

Enable Intel® AMT in the Intel® Management Engine BIOS Extension (MEBX) Screen

1. When the system reboots, the following message will be displayed. Press **<Ctrl-P>** as soon as the message is displayed; as this message will be displayed for only a few seconds.

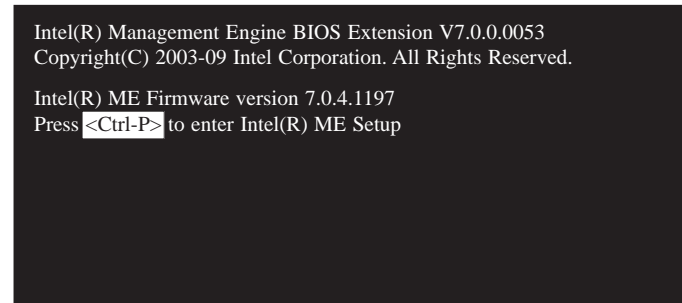

2. You will be prompted for a password. The default password is "**admin**". Enter the default password in the space provided under Intel(R) ME Password then press Enter.

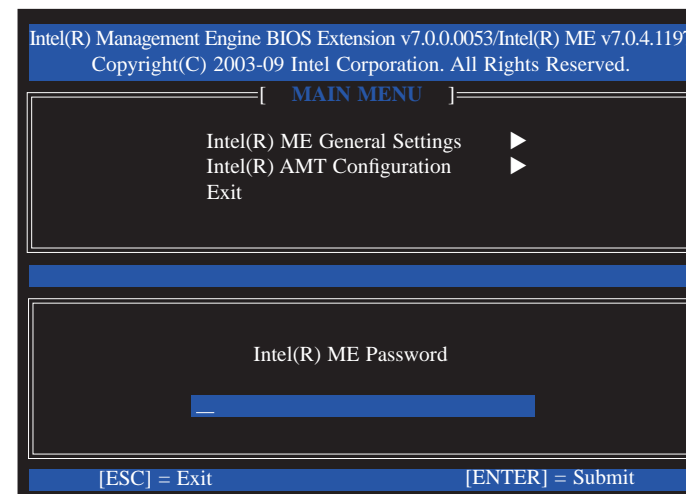

3. Enter a new password in the space provided under Intel(R) ME New Password then press Enter. The password must include:
- 8-32 characters
 - Strong 7-bit ASCII characters excluding : , and " characters
 - At least one digit character (0, 1, ...9)
 - At least one 7-bit ASCII non alpha-numeric character, above 0x20, (e.g. !, \$, ;)
 - Both lower case and upper case characters

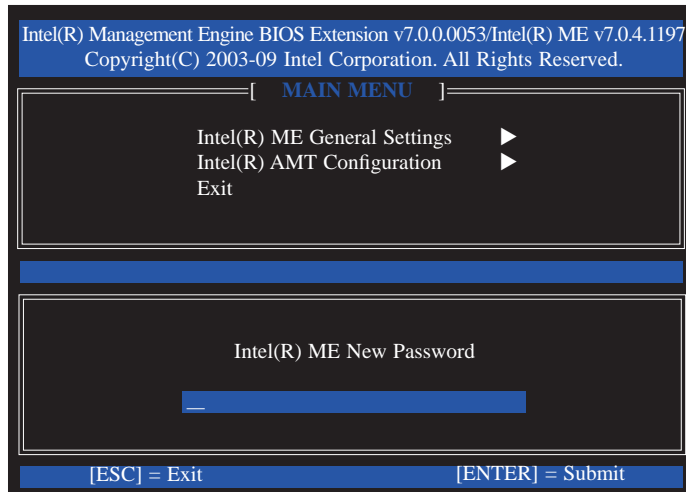

4. You will be asked to verify the password. Enter the same new password in the space provided under Verify Password then press Enter.

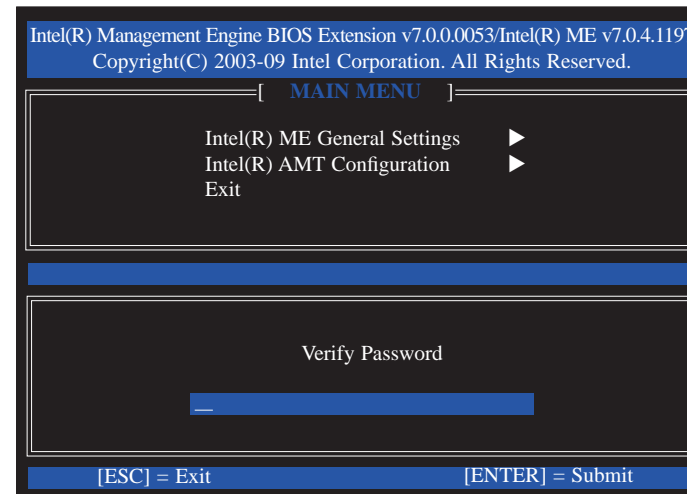

5. Select **Intel(R) ME General Settings** then press Enter.

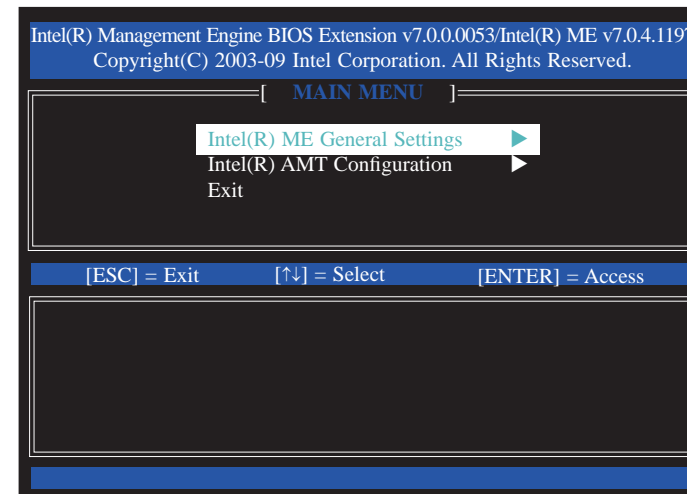

- Select **Change Intel(R) ME Password** then press Enter.

You will be prompted for a password. The default password is **"admin"**. Enter the default password in the space provided under Intel(R) ME New Password then press Enter.

- 8-32 characters
- Strong 7-bit ASCII characters excluding : , and " characters
- At least one digit character (0, 1, ...9)
- At least one 7-bit ASCII non alpha-numeric character, above 0x20, (e.g. !, \$, ;)
- Both lower case and upper case characters

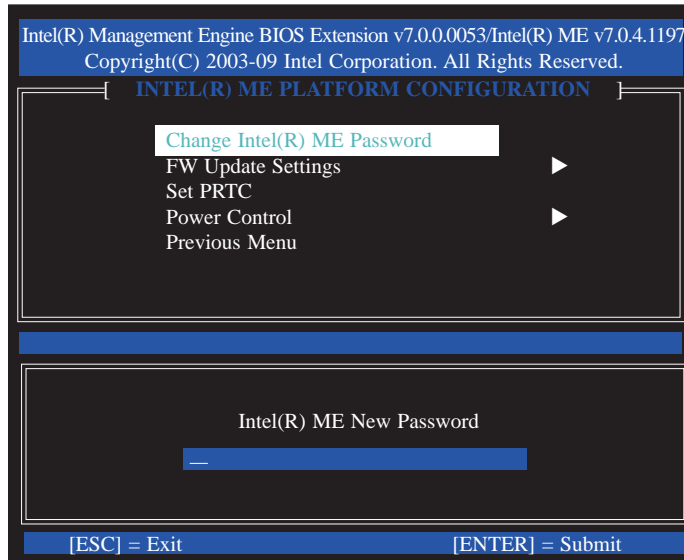

- Select **FW Update Settings** then press Enter.

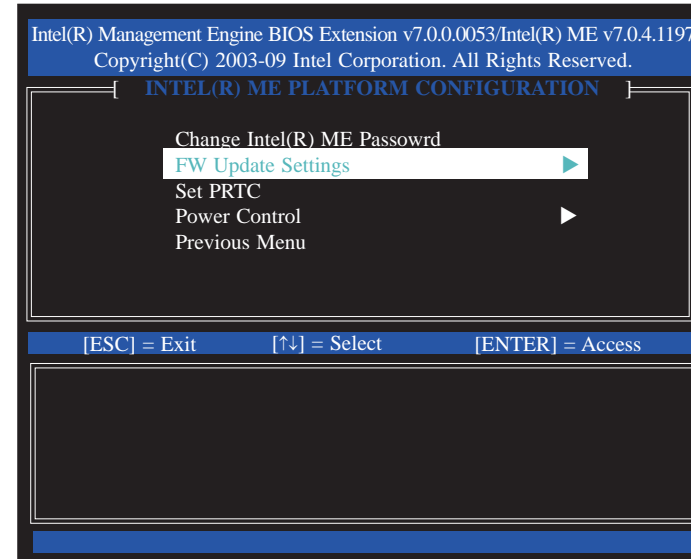

- In the **FW Update Settings** menu, select **Local FW Update** then press Enter. Select **Disabled** then press Enter.

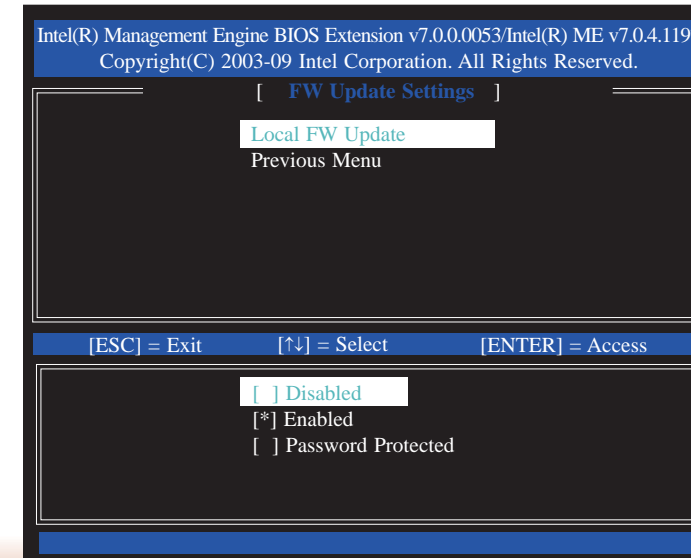

9. In the **Intel(R) ME Platform Configuration** menu, select **Set PRTC** then press Enter.

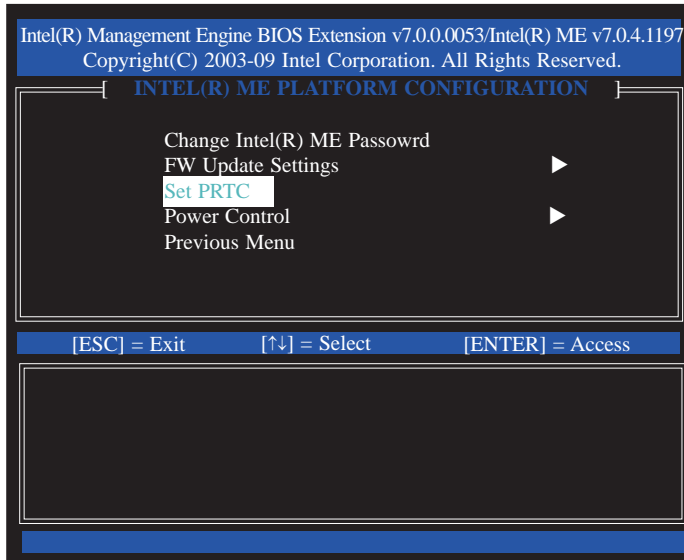

10. Enter the PRTC in GMT(UTC) format.

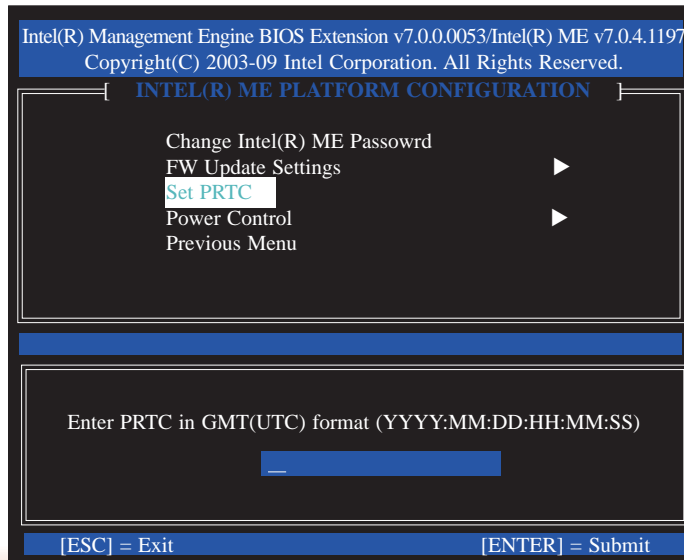

11. In the **Intel(R) ME Platform Configuration** menu, select **Power Control** then press Enter.

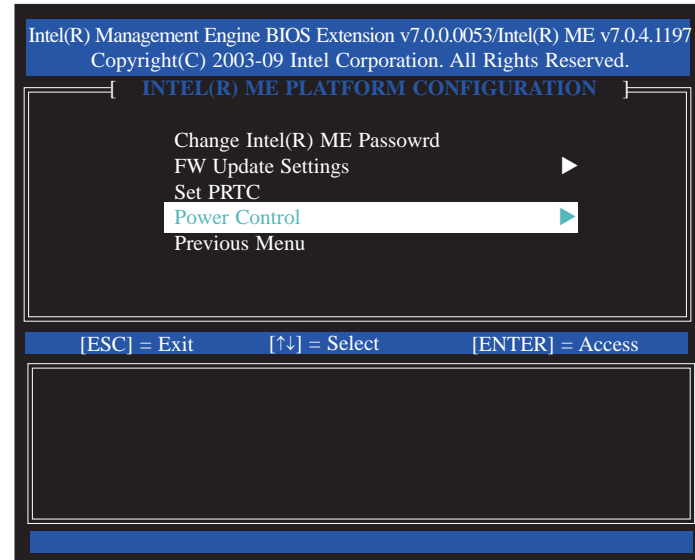

12. In the **Intel(R) ME Power Control** menu, select **Intel(R) ME ON in Host Sleep States** then press Enter. Select an option then press Enter.

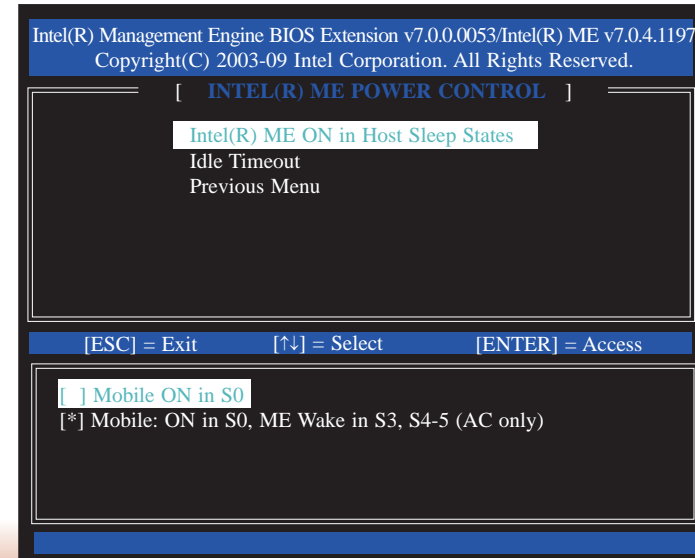

13. In the **Intel(R) ME Power Control** menu, select **Idle Timeout** then press Enter. Enter the timeout value.

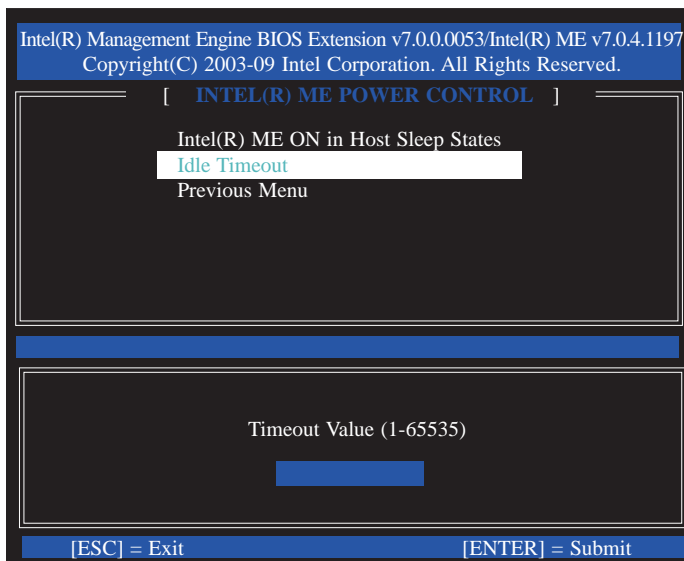

15. In the **Intel(R) AMT Configuration** menu, select **Manageability Feature Selection** then press Enter. Type Y then press Enter.

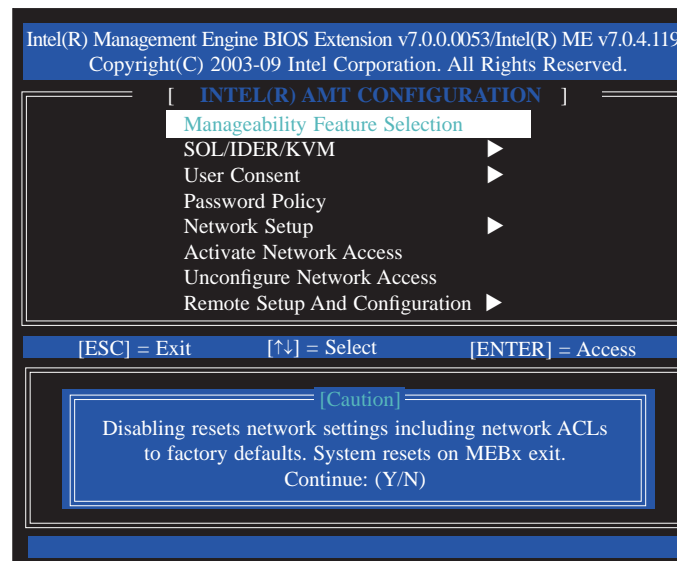

14. Select Previous Menu until you return to the **Main Menu**. Select **Intel(R) AMT Configuration** then press Enter.

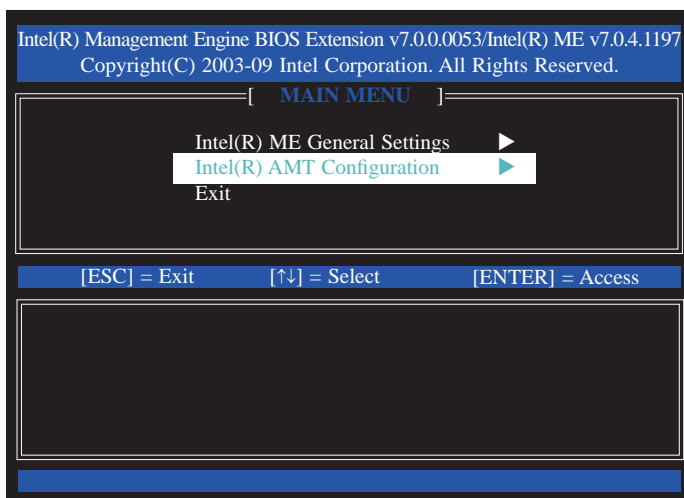

16. In the **Intel(R) AMT Configuration** menu, select **SOL/IDER/KVM** then press Enter.

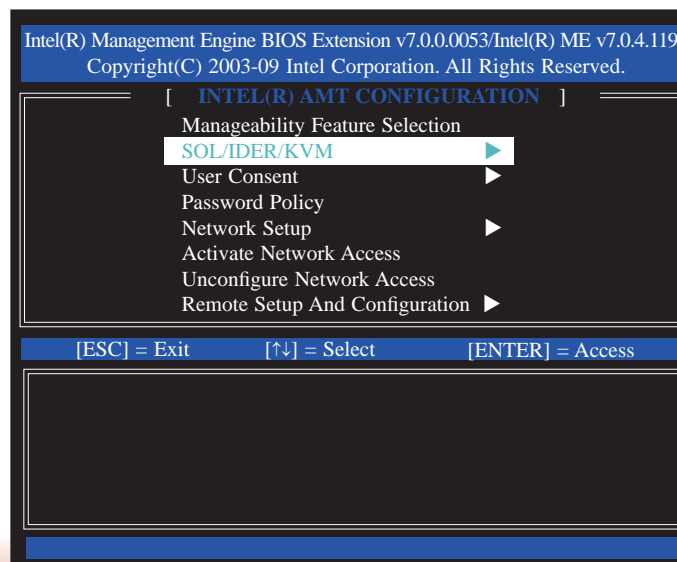

17. In the **SOL/IDER/KVM** menu, select **Username and Password** then press Enter. Select Disabled then press Enter.

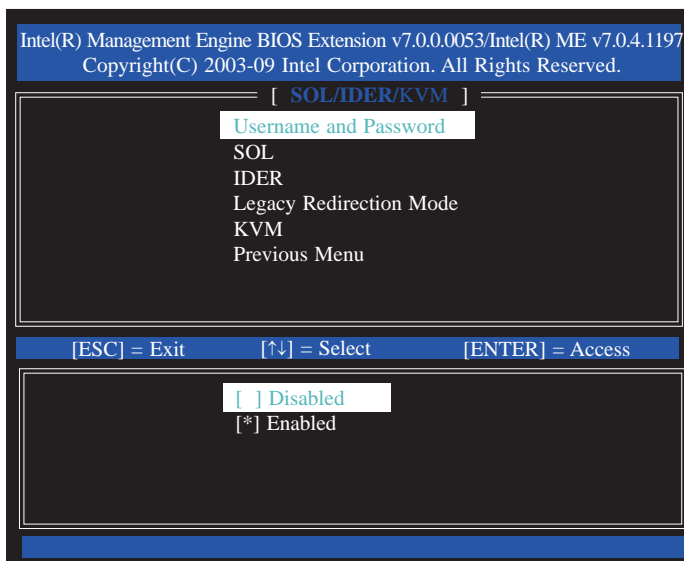

19. In the **SOL/IDER/KVM** menu, select **IDER** then press Enter. Select Disabled then press Enter.

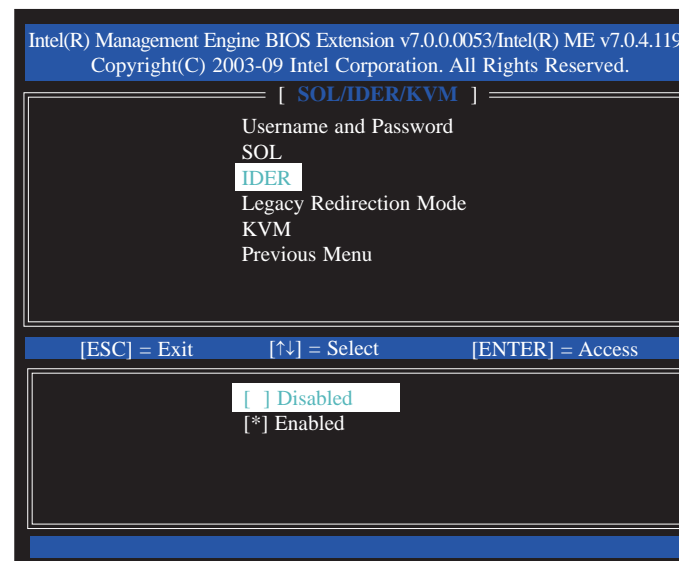

18. In the **SOL/IDER/KVM** menu, select **SOL** then press Enter. Select Disabled then press Enter.

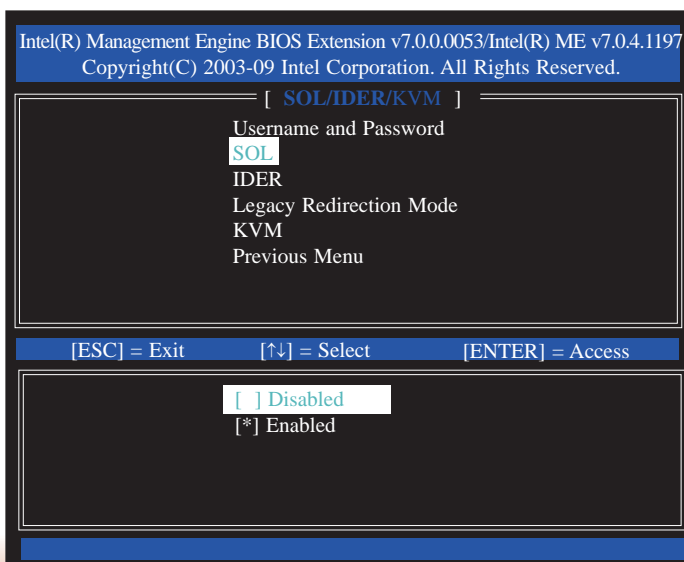

20. In the **SOL/IDER/KVM** menu, select **Legacy Redirection Mode** then press Enter.

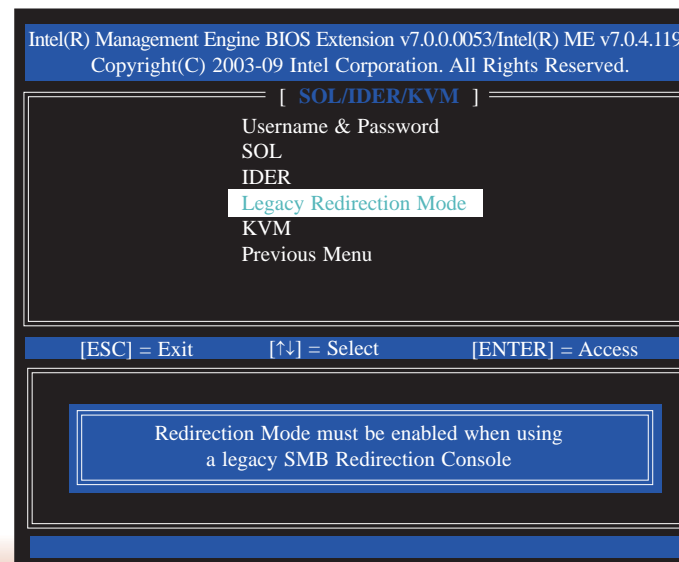

21. Select Enabled then press Enter.

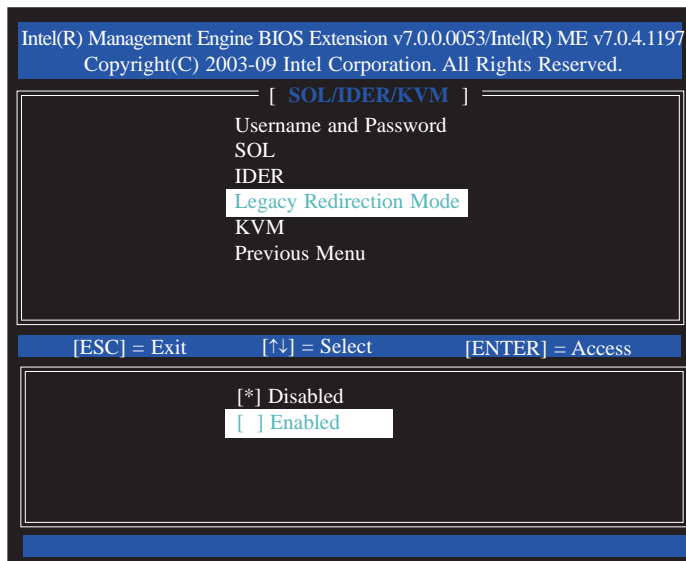

22. In the SOL/IDER/KVM menu, select KVM then press Enter. Select Disabled then press Enter.

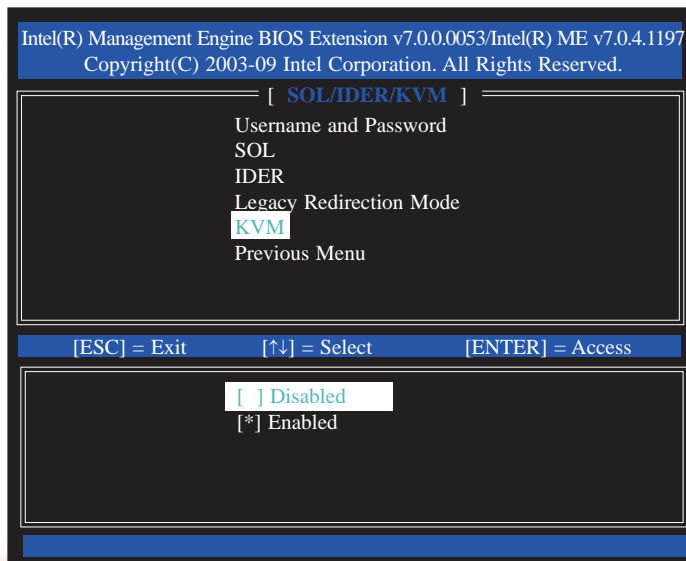

23. Select Previous Menu until you return to the Intel(R) AMT Configuration menu. Select User Consent then press Enter.

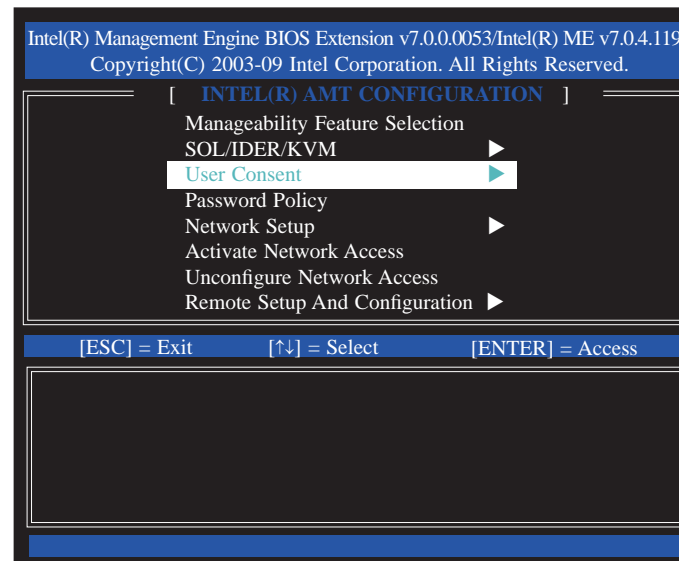

24. In the User Consent Configuration menu, select User Opt-in then press Enter. Select None then press Enter.

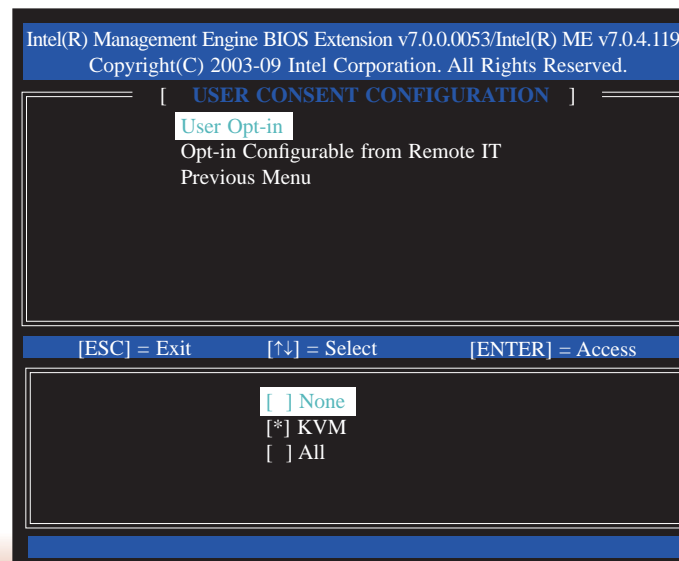

25. In the **User Consent Configuration** menu, select **Opt-in Configurable from Remote IT** then press Enter. Select **Disable Remote Control of KVM Opt-in Policy** then press Enter.

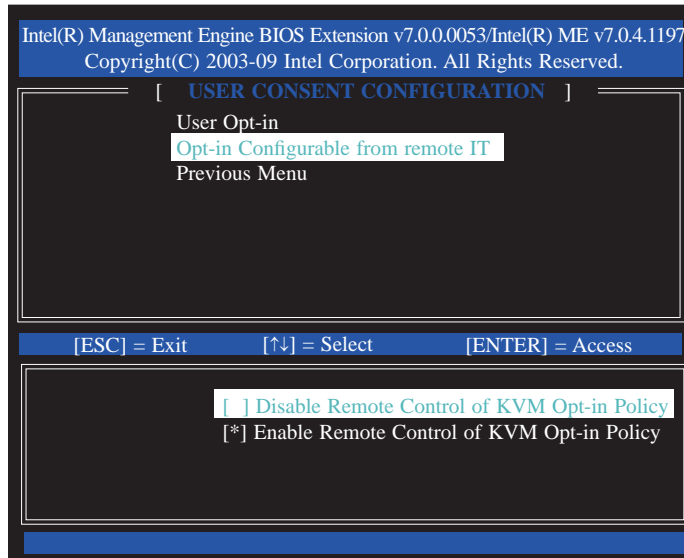

26. Select Previous Menu until you return to the **Intel(R) AMT Configuration** menu. Select **Password Policy** then press Enter.

You may choose to use a password only during setup and configuration or to use a password anytime the system is being accessed.

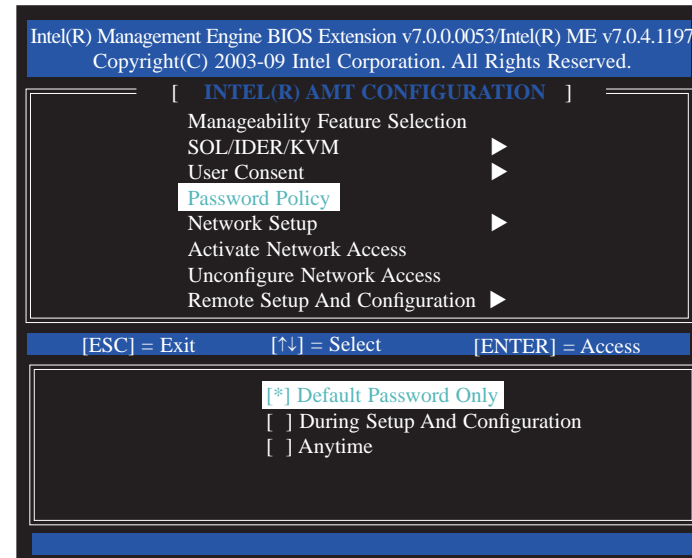

27. In the **Intel(R) AMT Configuration** menu, select **Network Setup** then press Enter.

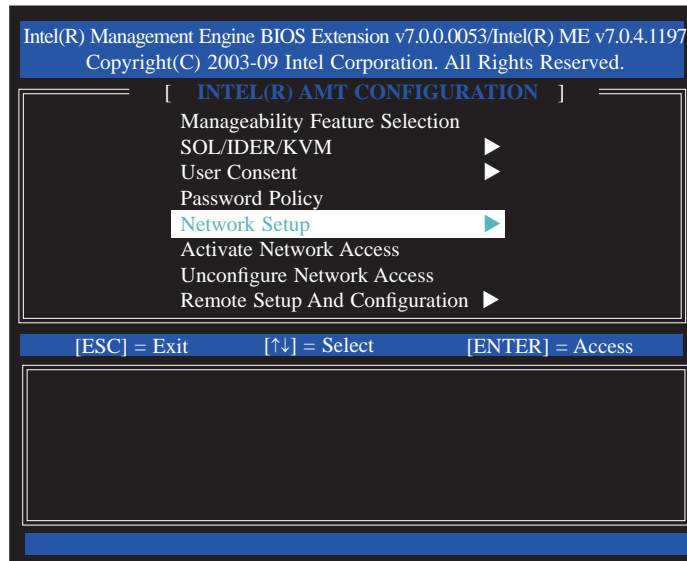

28. In the **Intel(R) Network Setup** menu, select **Intel(R) ME Network Name Settings** then press Enter.

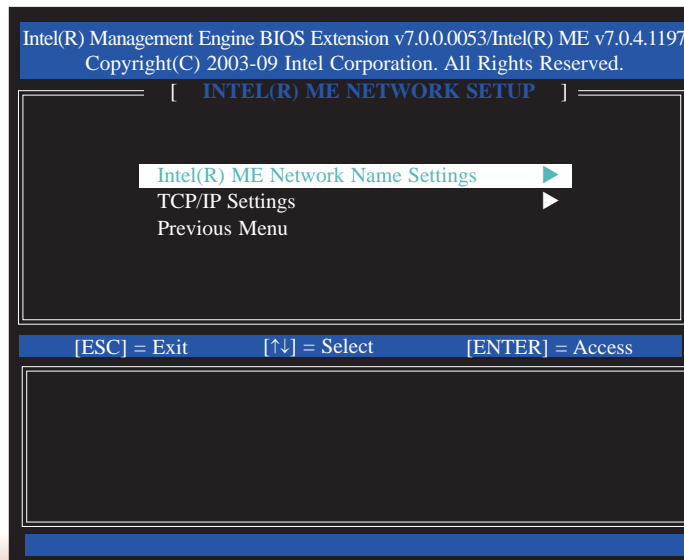

29. In the **Intel(R) ME Network Name Settings** menu, select **Host Name** then press Enter. Enter the computer's host name then press Enter.

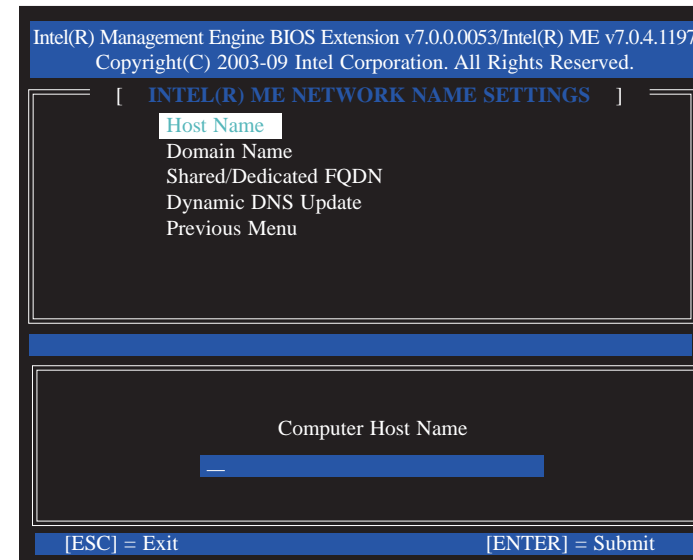

30. Select **Domain Name** then press Enter. Enter the computer's domain name then press Enter.

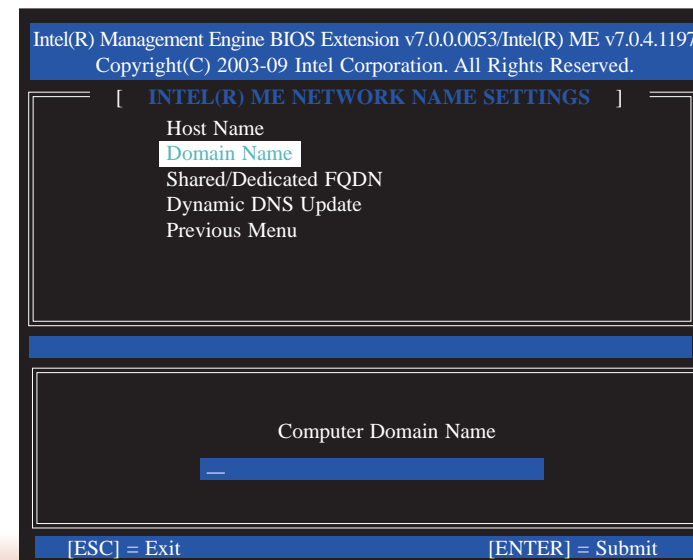

31. Select **Shared/Dedicated FQDN** then press Enter. Select Shared or Dedicated then press Enter.

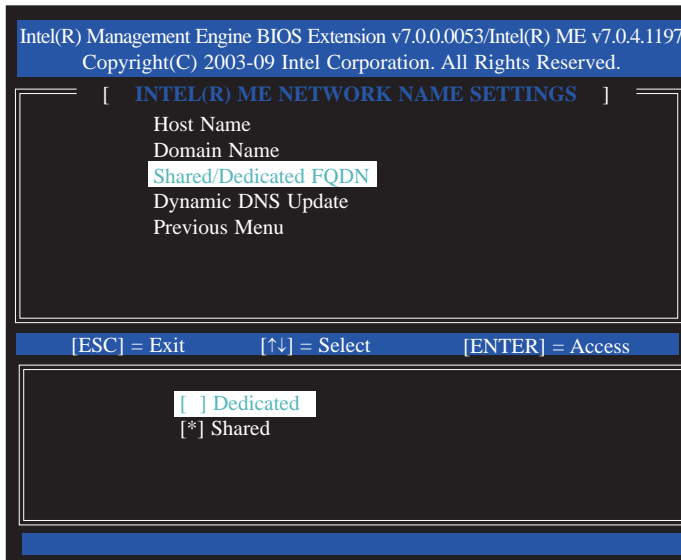

32. Select **Dynamic DNS Update** then press Enter. Select Enabled or Disabled then press Enter.

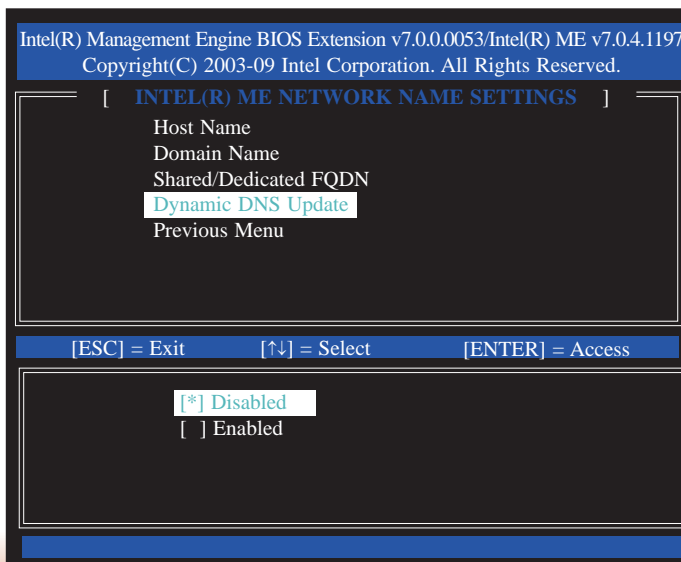

33. Select Previous Menu until you return to the **Intel(R) ME Network Setup** menu. Select **TCP/IP Settings** then press Enter.

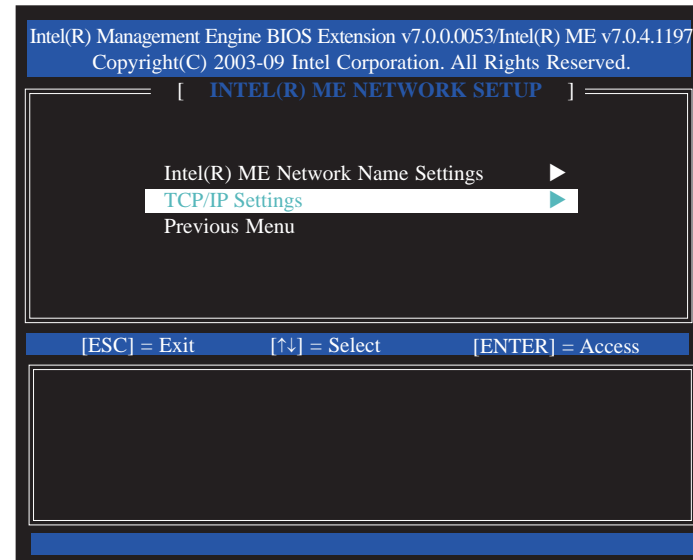

34. In the **TCP/IP Settings** menu, select **Wired LAN IPV4 Configuration** then press Enter.

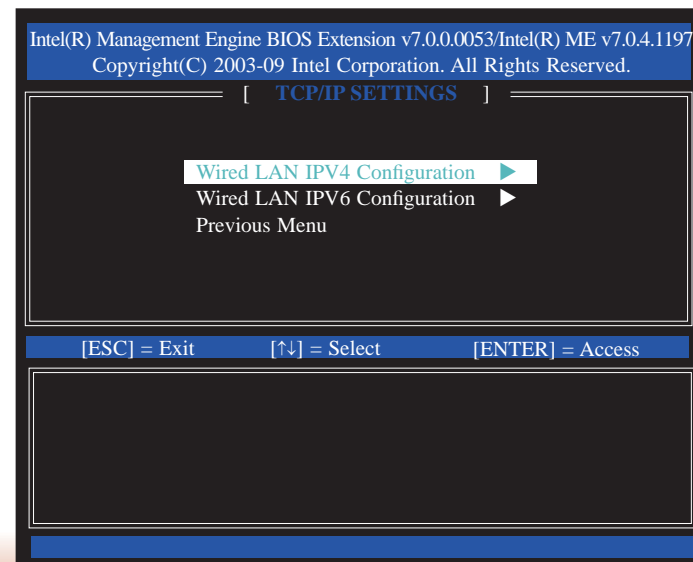

35. In the **Wired LAN IPv4 Configuration** menu, select **DHCP Mode** then press Enter. Select Disabled then press Enter.

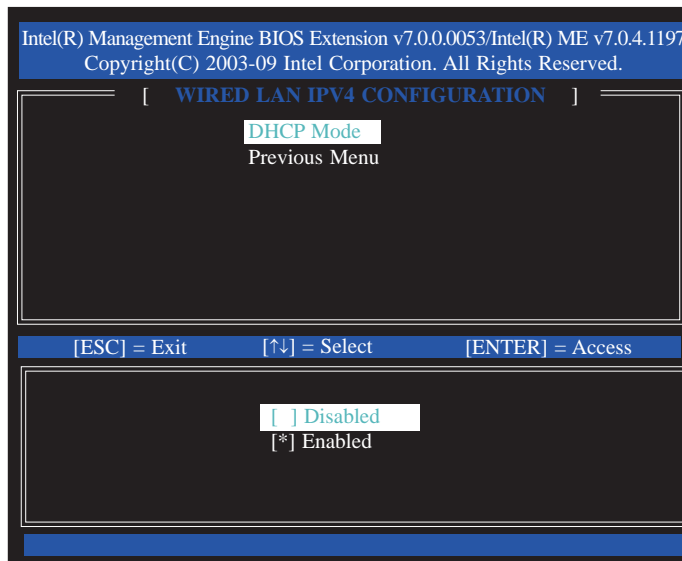

37. In the **Wired LAN IPv6 Configuration** menu, select **IPv6 Feature Selection** then press Enter. Select Disabled then press Enter.

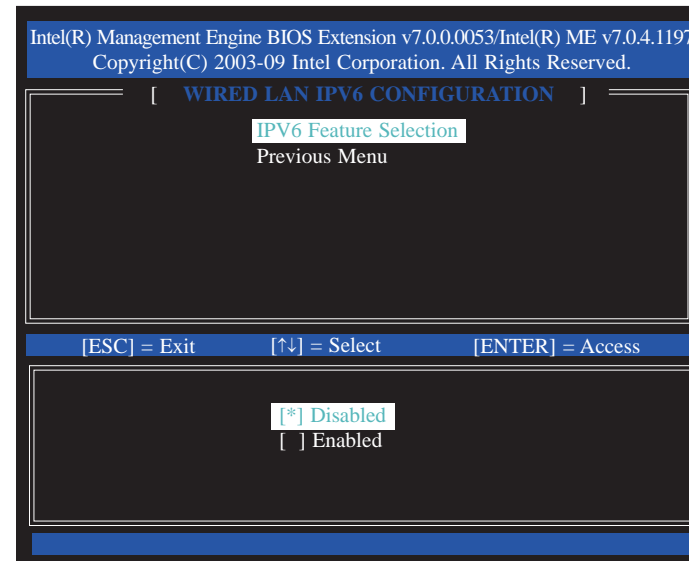

36. Select Previous Menu until you return to the **TCP/IP Settings** menu. Select **Wired LAN IPv6 Configuration** then press Enter.

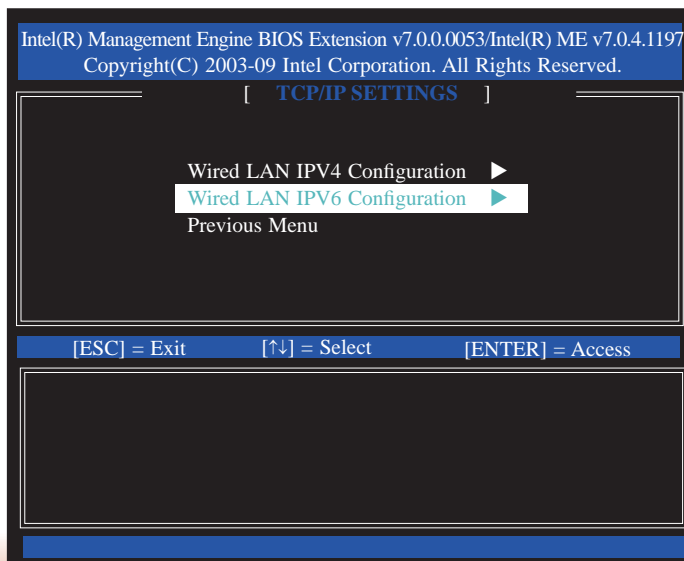

38. Select Previous Menu until you return to the **Intel(R) AMT Configuration** menu. Select **Activate Network Access** then press Enter. Type Y then press Enter.

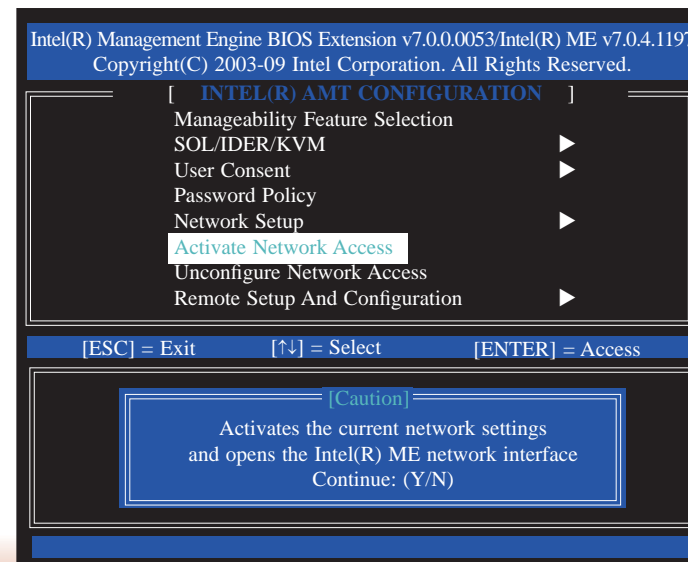

39. In the **Intel(R) AMT Configuration** menu, select **Unconfigure Network Access** then press Enter. Type **Y** then press Enter.

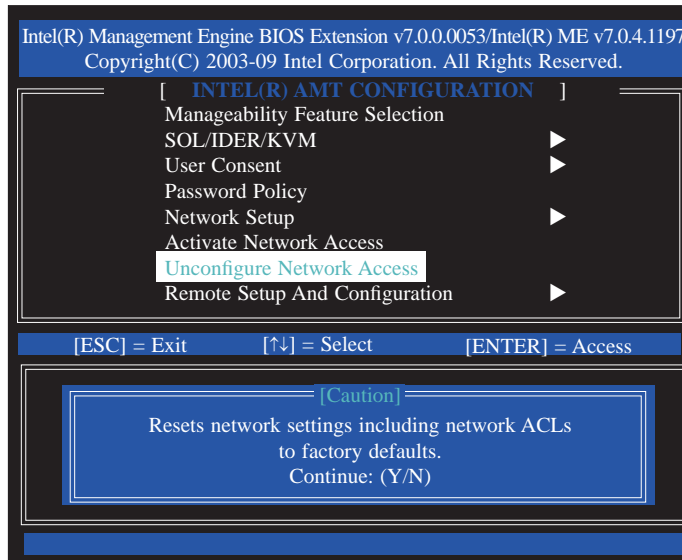

40. In the **Intel(R) AMT Configuration** menu, select **Remote Setup And Configuration** then press Enter.

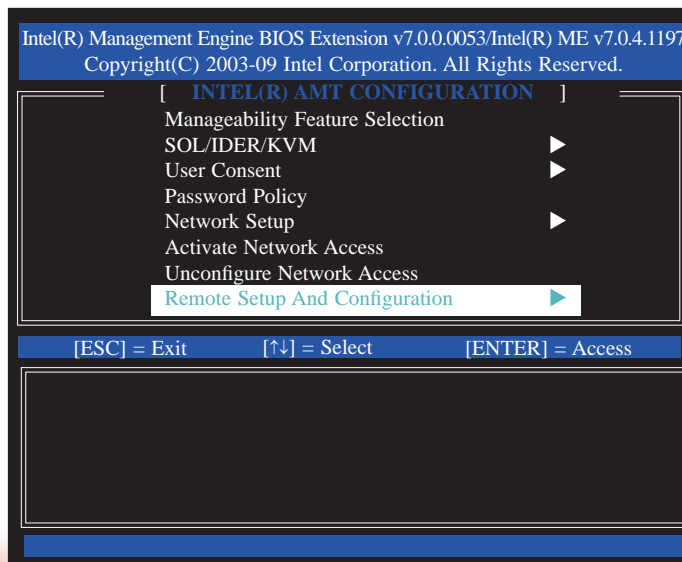

41. In the **Intel(R) Automated Setup And Configuration** menu, select **Current Provisioning Mode** then press Enter.

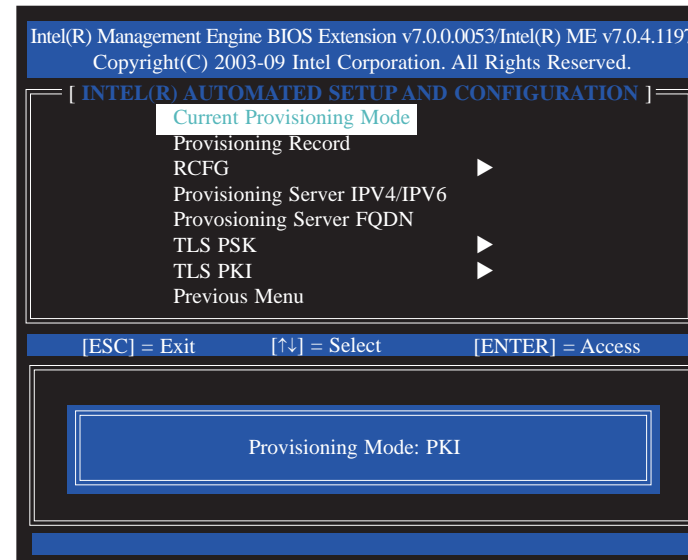

42. In the **Intel(R) Automated Setup And Configuration** menu, select **Provisioning Record** then press Enter.

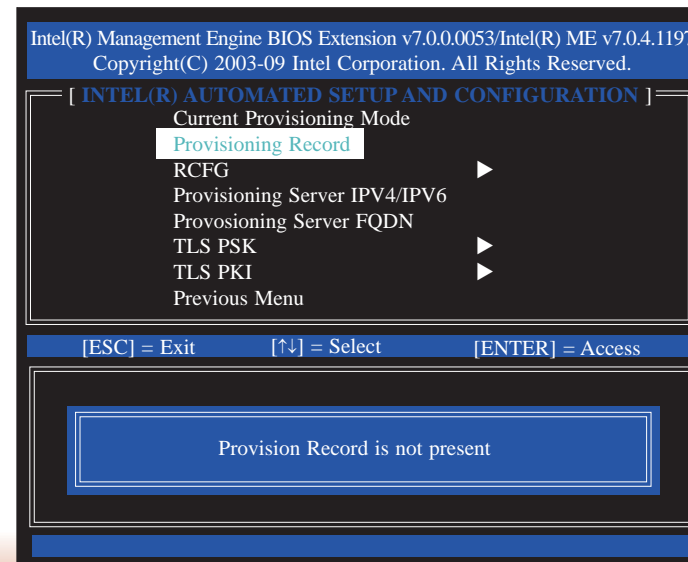

43. In the **Intel(R) Automated Setup And Configuration** menu, select **RCFG** then press Enter.

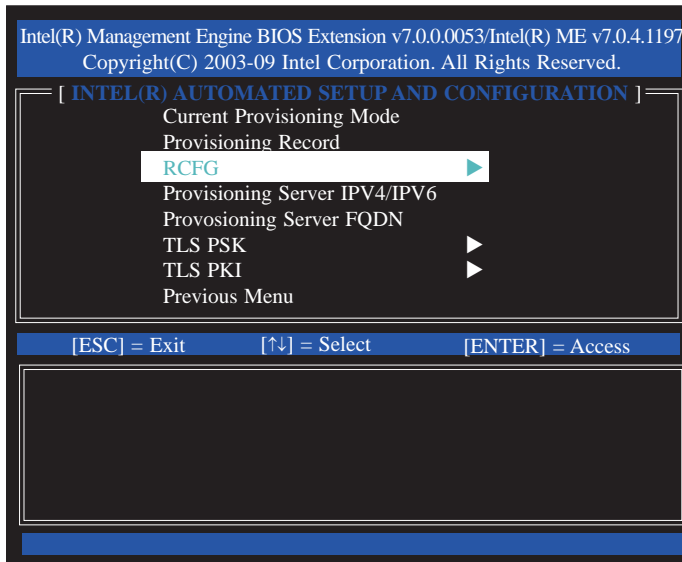

45. Select Previous Menu until you return to the **Intel(R) Automated Setup And Configuration** menu. Select **Provisioning Server IPV4/IPV6** then press Enter. Type server address then press Enter.

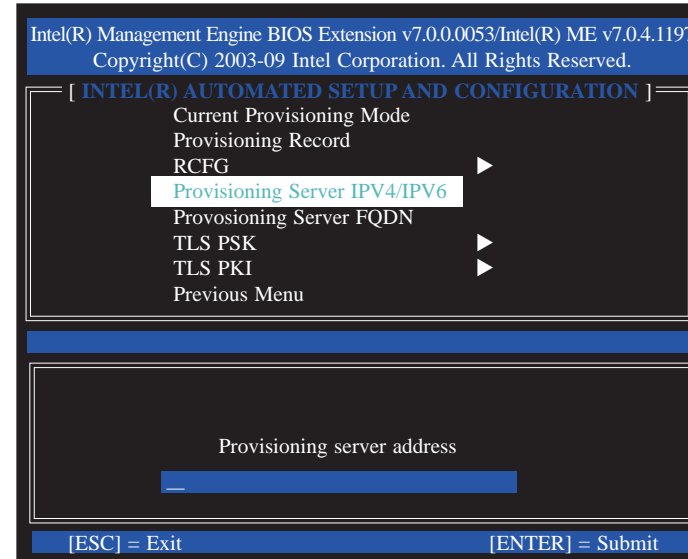

44. In the **Intel(R) Remote Configuration** menu, select **Start Configuration** then press Enter. Type **Y** then press Enter.

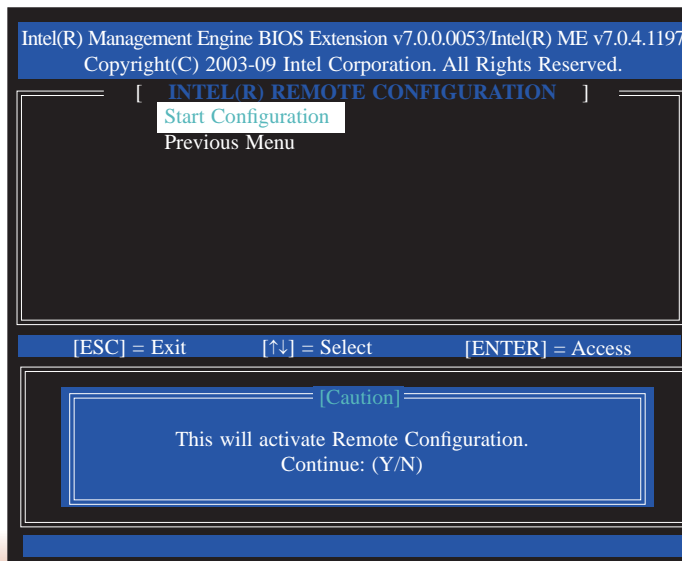

46. In the **Intel(R) Automated Setup And Configuration** menu, select **Provisioning Server FQDN** then press Enter. Type FQDN of provisioning server then press Enter.

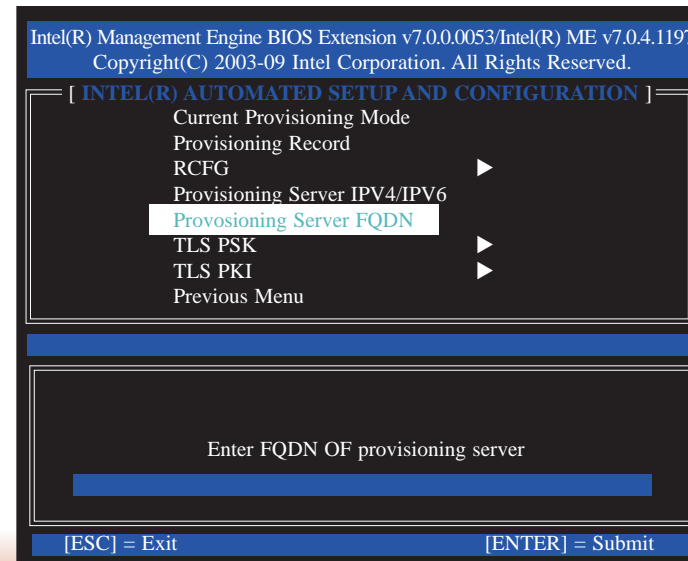

47. In the **Intel(R) Automated Setup And Configuration** menu, select **TLS PSK** then press Enter.

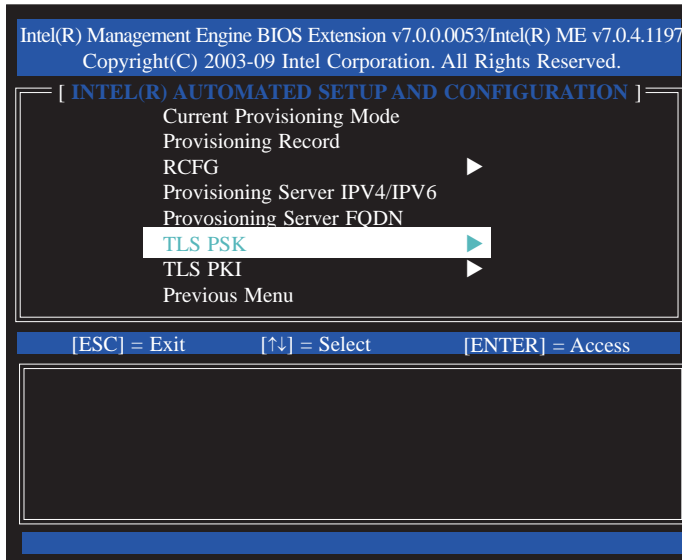

48. In the **Intel(R) Remote Configuration** menu, select **Set PID and PPS **** then press Enter. Type PID code then press Enter.

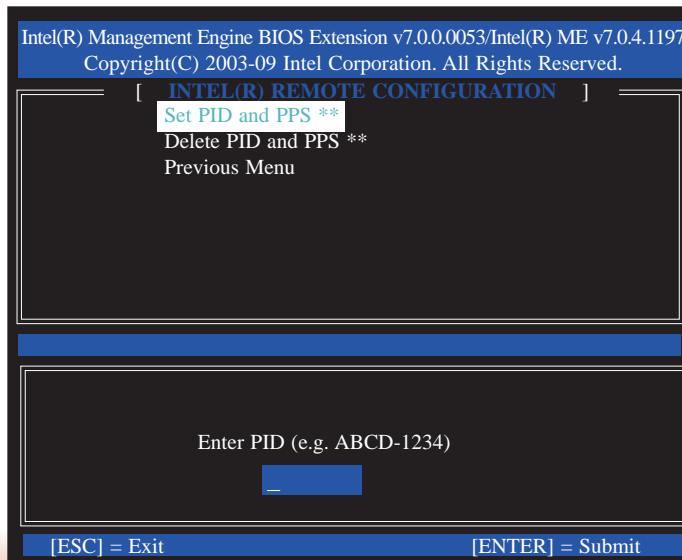

49. In the **Intel(R) Remote Configuration** menu, select **Delete PID and PPS **** then press Enter. Type Y then press Enter.

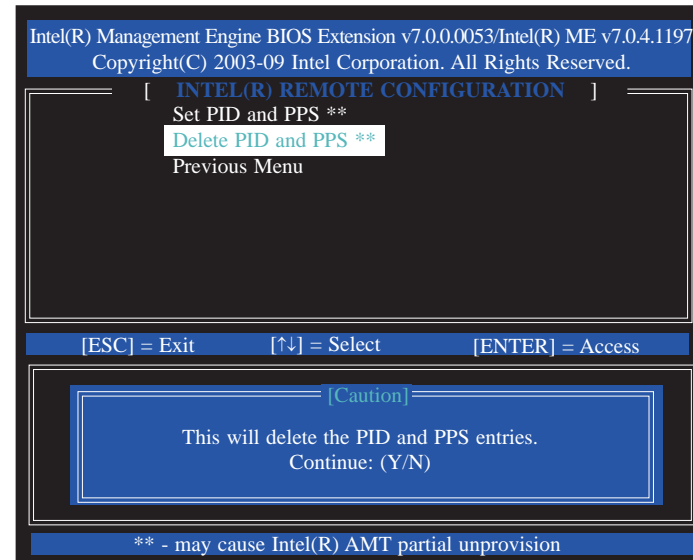

50. Select Previous Menu until you return to the **Intel(R) Automated Setup And Configuration** menu. Select **TLS PKI** then press Enter.

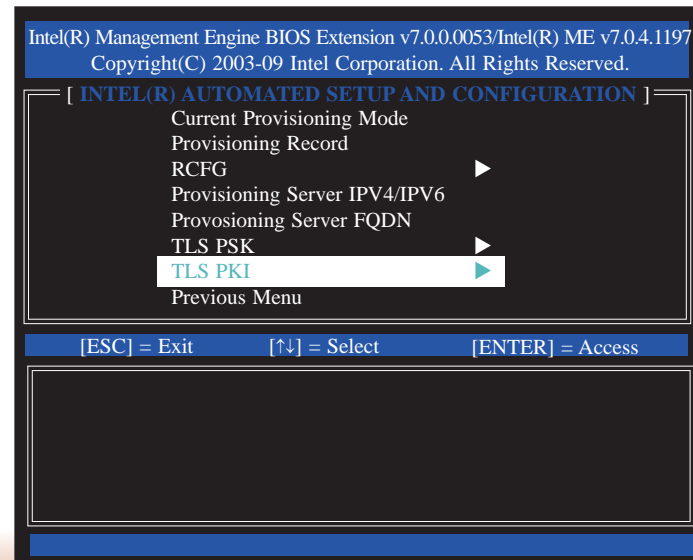

51. In the **Intel(R) Remote Configuration** menu, select **Remote Configuration **** then press Enter. Select **Disabled** then press Enter.

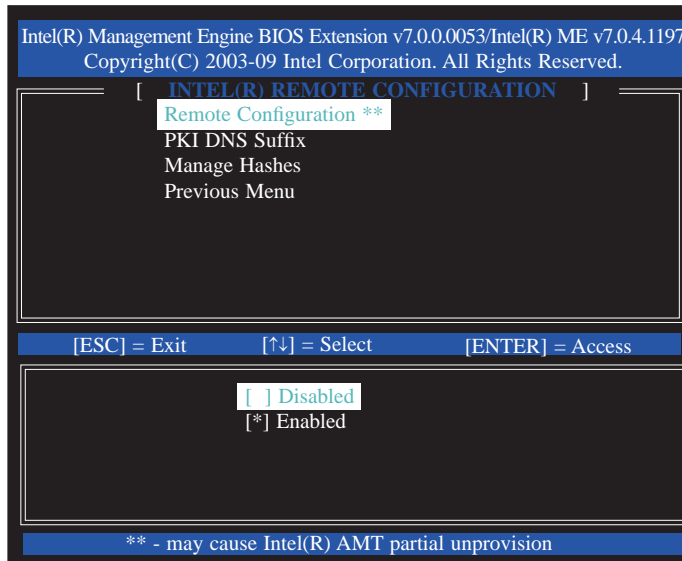

52. In the **Intel(R) Remote Configuration** menu, select **PKI DNS Suffix** then press Enter. Type **PKI DNS Suffix** then press Enter.

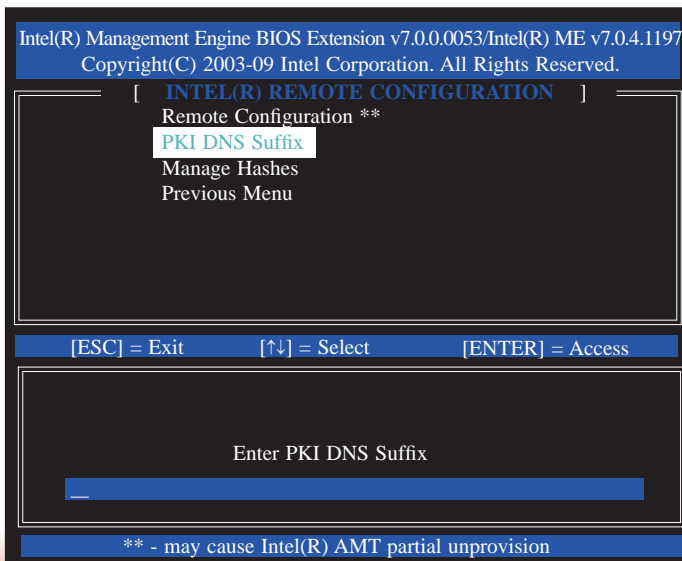

53. In the **Intel(R) Remote Configuration** menu, select **Manage Hashes** then press Enter.

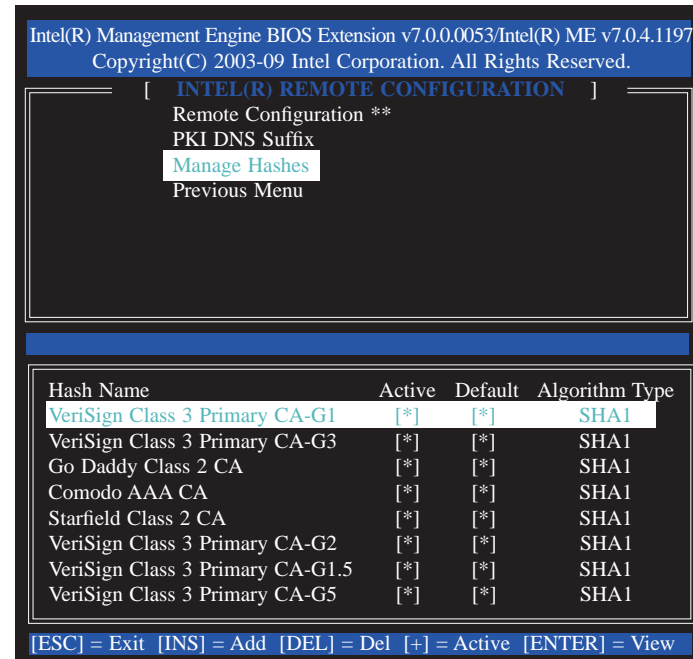

54. Select **Previous Menu** until you return to the **Main Menu**. Select **Exit** then press Enter. Type **Y** then press Enter.

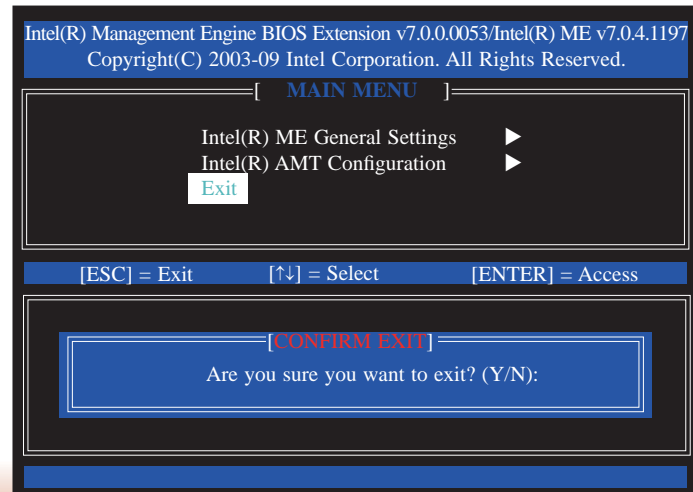

Appendix A - NLITE and AHCI Installation Guide

nLite

nLite is an application program that allows you to customize your XP installation disc by integrating the RAID/AHCI drivers into the disc. By using nLite, the F6 function key usually required during installation is no longer needed.



Note:

The installation steps below are based on nLite version 1.4.9. Installation procedures may slightly vary if you're using another version of the program.

1. Download the program from nLite's official website.

<http://www.nliteos.com/download.html>

2. Install nLite.



Important:

Due to its coding with Visual.Net, you may need to first install .NET Framework prior to installing nLite.

3. Download relevant RAID/AHCI driver files from Intel's website. The drivers you choose will depend on the operating system and chipset used by your computer.

The downloaded driver files should include iaahci.cat, iaAHCI.inf, iastor.cat, iaStor.inf, iaStor.sys, license.txt and TXTSETUP.OEM.

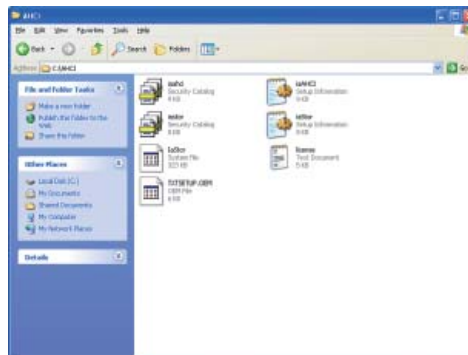

4. Insert the XP installation disc into an optical drive.
5. Launch nLite. The Welcome screen will appear. Click **Next**.

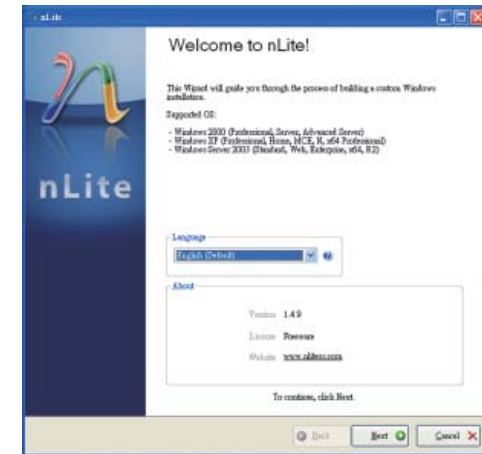

6. Click **Next** to temporarily save the Windows installation files to the designated default folder.

If you want to save them in another folder, click **Browse**, select the folder and then click **Next**.

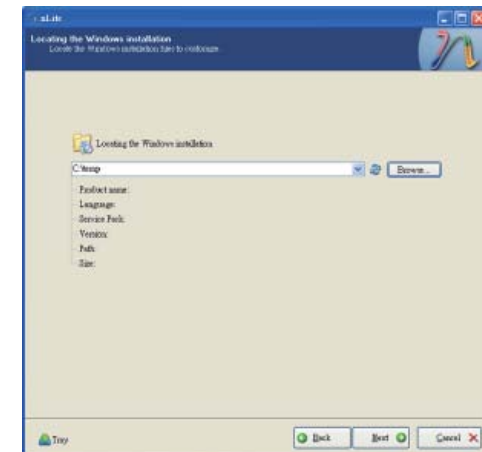

7. Click **Next**.

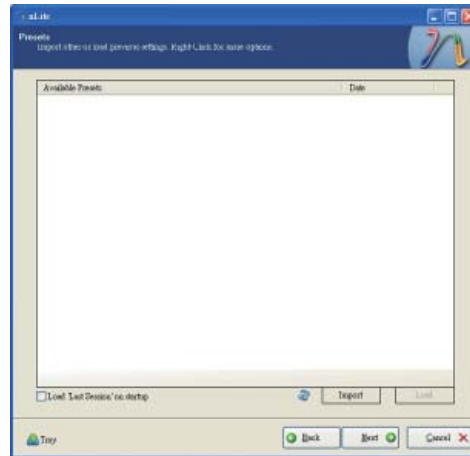

8. In the Task Selection dialog box, click **Drivers** and **Bootable ISO**. Click **Next**.



9. Click **Insert** and then select **Multiple driver folder** to select the drivers you will integrate. Click **Next**.

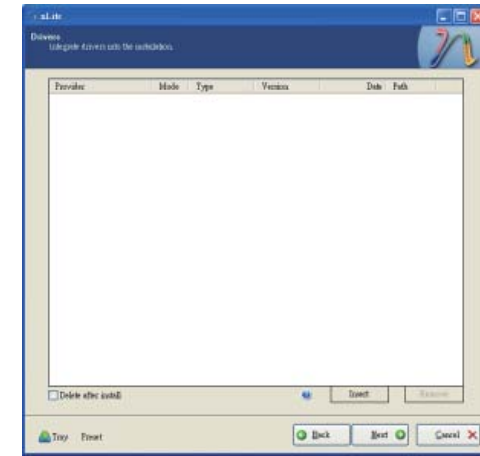

10. Select only the drivers appropriate for the Windows version that you are using and then click **OK**.

Integrating 64-bit drivers into 32-bit Windows or vice versa will cause file load errors and failed installation.

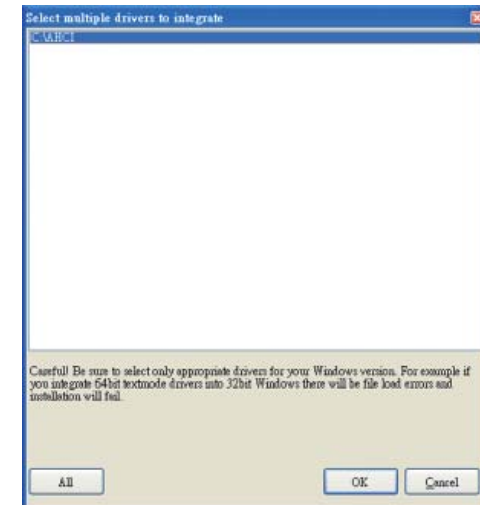

15. To create an image, select the **Create Image** mode under the General section and then click **Next**.

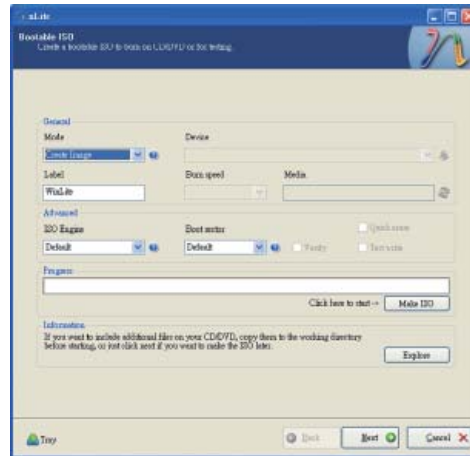

16. Or you can choose to burn it directly to a disc by selecting the **Direct Burn** mode under the General section.

Select the optical device and all other necessary settings and then click **Next**.

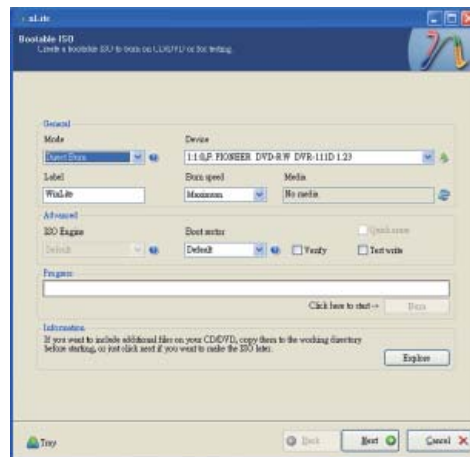

17. You have finished customizing the Windows XP installation disc. Click **Finish**.

Enter the BIOS utility to configure the SATA controller to RAID/AHCI. You can now install Windows XP.

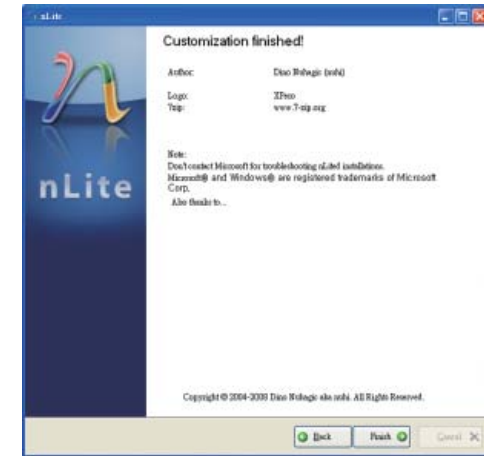

AHCI

The installation steps below will guide you in configuring your SATA drive to AHCI mode.

1. Enter the BIOS utility and configure the SATA controller to IDE mode.
2. Install Windows XP but do not press F6.
3. Download relevant RAID/AHCI driver files supported by the motherboard chipset from Intel's website.

Transfer the downloaded driver files to C:\AHCI.

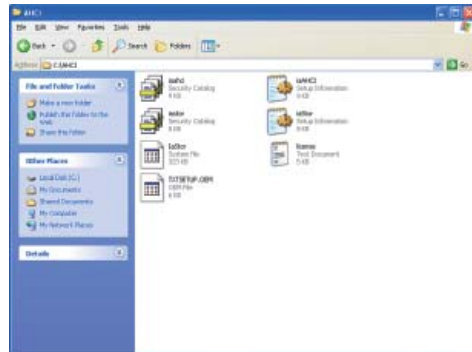

4. Open Device Manager and right click on one of the Intel Serial ATA Storage Controllers, then select **Update Driver**.

If the controller you selected did not work, try selecting another one.

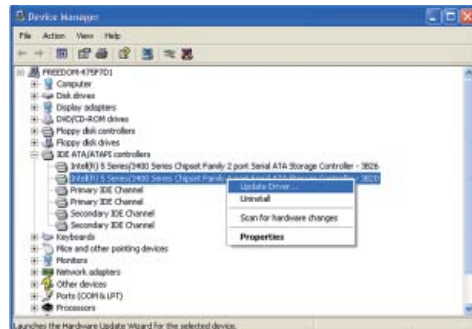

5. In the Hardware Update Wizard dialog box, select **"No, not this time"** then click **Next**.



6. Select **"Install from a list or specific location (Advanced)"** and then click **Next**.

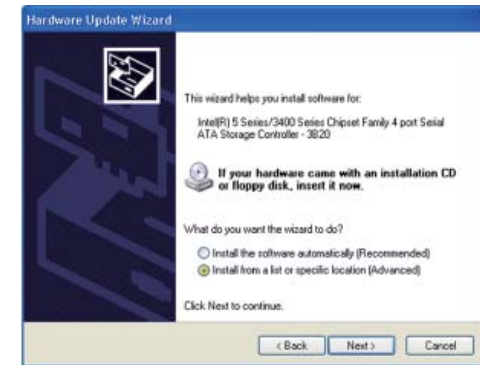

7. Select **"Don't search. I will choose the driver to install"** and then click **Next**.

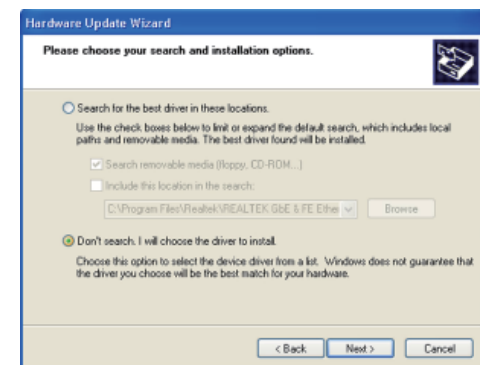

8. Click **“Have Disk”**.

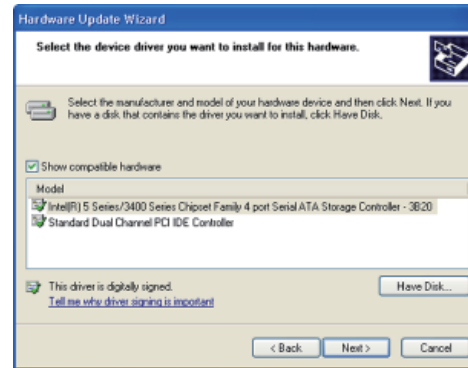

9. Select C:\AHCI\iaAHCI.inf and then click **Open**.

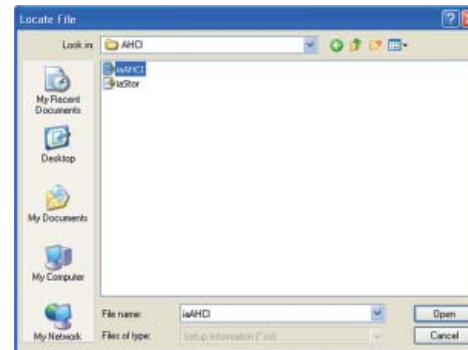

10. Select the appropriate AHCI Controller of your hardware device and then click **Next**.

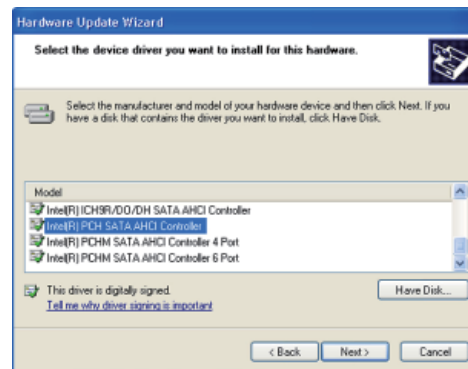

11. A warning message appeared because the selected SATA controller did not match your hardware device.

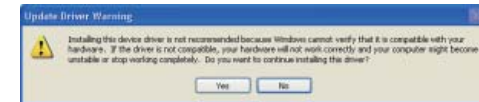

Ignore the warning and click **Yes** to proceed.

12. Click **Finish**.

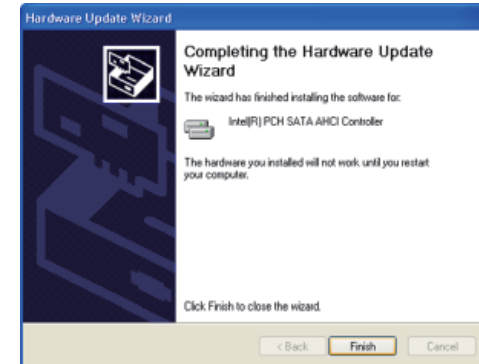

13. The system's settings have been changed. Windows XP requires that you restart the computer. Click **Yes**.



14. Enter the BIOS utility and modify the SATA controller from IDE to AHCI. By doing so, Windows will work normally with the SATA controller that is in AHCI mode.

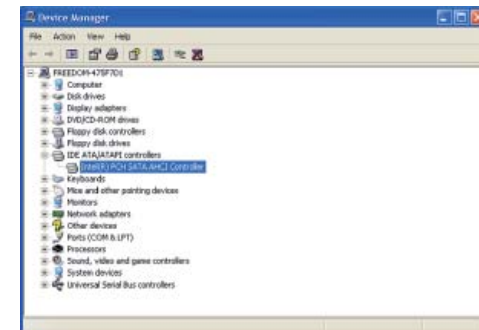

Appendix B - Watchdog Sample Code

;Software programming example:

```

;-----
;(1) Enter Super IO Configuration mode
;-----
MOV     DX,2EH
MOV     AL,87H
OUT     DX,AL
OUT     DX,AL

;-----
;(2) Configuration Logical Device 7, register CRF5/CRF6 (WDT Control /WDT
timer)
;-----
MOV     DX,2EH
MOV     AL,07H           ;Ready to Program Logical Device
OUT     DX,AL

MOV     DX,2FH
MOV     AL,07H           ;Select Logical Device 7
OUT     DX,AL

MOV     DX,2EH
MOV     AL, F6H           ;Select watchdog timer register
OUT     DX,AL

MOV     DX,2FH
MOV     AL,10H           ;Set watchdog timer value
OUT     DX,AL

MOV     DX,2EH
MOV     AL, F5H           ;Select watchdog Control Register
OUT     DX,AL

MOV     DX,2FH
MOV     AL,61H           ;Set Watchdog Control Value
OUT     DX,AL

;-----
;(1) Exit extended function mode
;-----
MOV     DX,2EH
MOV     AL,AAH
OUT     DX,AL

```

Appendix C - System Error Message

When the BIOS encounters an error that requires the user to correct something, either a beep code will sound or a message will be displayed in a box in the middle of the screen and the message, PRESS F1 TO CONTINUE, CTRL-ALT-ESC or DEL TO ENTER SETUP, will be shown in the information box at the bottom. Enter Setup to correct the error.

Error Messages

One or more of the following messages may be displayed if the BIOS detects an error during the POST. This list indicates the error messages for all Awards BIOSes:

CMOS BATTERY HAS FAILED

The CMOS battery is no longer functional. It should be replaced.



Important

Danger of explosion if battery incorrectly replaced. Replace only with the same or equivalent type recommended by the manufacturer. Dispose of used batteries according to the battery manufacturer's instructions.

CMOS CHECKSUM ERROR

Checksum of CMOS is incorrect. This can indicate that CMOS has become corrupt. This error may have been caused by a weak battery. Check the battery and replace if necessary.

DISPLAY SWITCH IS SET INCORRECTLY

The display switch on the motherboard can be set to either monochrome or color. This indicates the switch is set to a different setting than indicated in Setup. Determine which setting is correct, either turn off the system and change the jumper or enter Setup and change the VIDEO selection.

FLOPPY DISK(S) fail (80)

Unable to reset floppy subsystem.

FLOPPY DISK(S) fail (40)

Floppy type mismatch.

Hard Disk(s) fail (80)

HDD reset failed.

Hard Disk(s) fail (40)

HDD controller diagnostics failed.

Hard Disk(s) fail (20)

HDD initialization error.

Hard Disk(s) fail (10)

Unable to recalibrate fixed disk.

Hard Disk(s) fail (08)

Sector Verify failed.

Keyboard is locked out - Unlock the key

The BIOS detects that the keyboard is locked. Keyboard controller is pulled low.

Keyboard error or no keyboard present

Cannot initialize the keyboard. Make sure the keyboard is attached correctly and no keys are being pressed during the boot.

Manufacturing POST loop

System will repeat POST procedure infinitely while the keyboard controller is pull low. This is also used for the M/B burn in test at the factory.

BIOS ROM checksum error - System halted

The checksum of ROM address F0000H-FFFFFFH is bad.

Memory test fail

The BIOS reports memory test fail if the memory has error(s).

Appendix D - Troubleshooting Checklist

Troubleshooting Checklist

This chapter of the manual is designed to help you with problems that you may encounter with your personal computer. To efficiently troubleshoot your system, treat each problem individually. This is to ensure an accurate diagnosis of the problem in case a problem has multiple causes.

Some of the most common things to check when you encounter problems while using your system are listed below.

1. The power switch of each peripheral device is turned on.
2. All cables and power cords are tightly connected.
3. The electrical outlet to which your peripheral devices are connected is working. Test the outlet by plugging in a lamp or other electrical device.
4. The monitor is turned on.
5. The display's brightness and contrast controls are adjusted properly.
6. All add-in boards in the expansion slots are seated securely.
7. Any add-in board you have installed is designed for your system and is set up correctly.

Monitor/Display

If the display screen remains dark after the system is turned on:

1. Make sure that the monitor's power switch is on.
2. Check that one end of the monitor's power cord is properly attached to the monitor and the other end is plugged into a working AC outlet. If necessary, try another outlet.
3. Check that the video input cable is properly attached to the monitor and the system's display adapter.
4. Adjust the brightness of the display by turning the monitor's brightness control knob.

The picture seems to be constantly moving.

1. The monitor has lost its vertical sync. Adjust the monitor's vertical sync.
2. Move away any objects, such as another monitor or fan, that may be creating a magnetic field around the display.
3. Make sure your video card's output frequencies are supported by this monitor.

The screen seems to be constantly wavering.

1. If the monitor is close to another monitor, the adjacent monitor may need to be turned off. Fluorescent lights adjacent to the monitor may also cause screen wavering.

Power Supply

When the computer is turned on, nothing happens.

1. Check that one end of the AC power cord is plugged into a live outlet and the other end properly plugged into the back of the system.
2. Make sure that the voltage selection switch on the back panel is set for the correct type of voltage you are using.
3. The power cord may have a "short" or "open". Inspect the cord and install a new one if necessary.

Floppy Drive

The computer cannot access the floppy drive.

1. The floppy diskette may not be formatted. Format the diskette and try again.
2. The diskette may be write-protected. Use a diskette that is not write-protected.
3. You may be writing to the wrong drive. Check the path statement to make sure you are writing to the targeted drive.
4. There is not enough space left on the diskette. Use another diskette with adequate storage space.

Hard Drive

Hard disk failure.

1. Make sure the correct drive type for the hard disk drive has been entered in the BIOS.
2. If the system is configured with two hard drives, make sure the bootable (first) hard drive is configured as Master and the second hard drive is configured as Slave. The master hard drive must have an active/bootable partition.

Excessively long formatting period.

If your hard drive takes an excessively long period of time to format, it is likely a cable connection problem. However, if your hard drive has a large capacity, it will take a longer time to format.

Serial Port

The serial device (modem, printer) doesn't output anything or is outputting garbled characters.

1. Make sure that the serial device's power is turned on and that the device is on-line.
2. Verify that the device is plugged into the correct serial port on the rear of the computer.
3. Verify that the attached serial device works by attaching it to a serial port that is working and configured correctly. If the serial device does not work, either the cable or the serial device has a problem. If the serial device works, the problem may be due to the onboard I/O or the address setting.
4. Make sure the COM settings and I/O address are configured correctly.

Keyboard

Nothing happens when a key on the keyboard was pressed.

1. Make sure the keyboard is properly connected.
2. Make sure there are no objects resting on the keyboard and that no keys are pressed during the booting process.

System Board

1. Make sure the add-in card is seated securely in the expansion slot. If the add-in card is loose, power off the system, re-install the card and power up the system.
2. Check the jumper settings to ensure that the jumpers are properly set.
3. Verify that all memory modules are seated securely into the memory sockets.
4. Make sure the memory modules are in the correct locations.
5. If the board fails to function, place the board on a flat surface and seat all socketed components. Gently press each component into the socket.
6. If you made changes to the BIOS settings, re-enter setup and load the BIOS defaults.