

ADN253

Intel® Atom® Alder Lake-N Processors
User's Manual

Copyright

This publication contains information that is protected by copyright. No part of it may be reproduced in any form or by any means or used to make any transformation/adaptation without the prior written permission from the copyright holders.

This publication is provided for informational purposes only. The manufacturer makes no representations or warranties with respect to the contents or use of this manual and specifically disclaims any express or implied warranties of merchantability or fitness for any particular purpose. The user will assume the entire risk of the use or the results of the use of this document. Further, the manufacturer reserves the right to revise this publication and make changes to its contents at any time, without obligation to notify any person or entity of such revisions or changes.

Changes after the publication's first release will be based on the product's revision. The website will always provide the most updated information.

© 2025. All Rights Reserved.

Trademarks

Product names or trademarks appearing in this manual are for identification purpose only and are the properties of the respective owners.

FCC and DOC Statement on Class A

This equipment has been tested and found to comply with the limits for a Class A digital device, pursuant to Part 15 of the FCC rules. These limits are designed to provide reasonable protection against harmful interference when the equipment is operated in a residential installation. This equipment generates, uses and can radiate radio frequency energy and, if not installed and used in accordance with the instruction manual, may cause harmful interference to radio communications. However, there is no guarantee that interference will not occur in a particular installation. If this equipment does cause harmful interference to radio or television reception, which can be determined by turning the equipment off and on, the user is encouraged to try to correct the interference by one or more of the following measures:

- Reorient or relocate the receiving antenna.
- Increase the separation between the equipment and the receiver.
- Connect the equipment into an outlet on a circuit different from that to which the receiver is connected.
- Consult the dealer or an experienced radio TV technician for help.

Notice:

1. The changes or modifications not expressly approved by the party responsible for compliance could void the user's authority to operate the equipment.
2. Shielded interface cables must be used in order to comply with the emission limits.

Table of Contents

Chapter 1 - Introduction.....	6
Specifications	6
Dimensions	8
Block Diagram	8
Chapter 2 - Hardware Installations.....	9
Overview.....	9
Top View.....	9
Bottom View.....	9
Jumper Settings	10
BL_ON/OFF Selection (DPJP1).....	10
INV_PWR Selection (DPJP2).....	10
VCC_PANEL Selection (DPJP3).....	11
COM4/DIO Selection (JP1 & JP2).....	11
Pin Assignment	12
I2C Header (J8).....	12
SATA Power (CN11).....	12
Front Panel (JP4).....	13
USB2.0 / Case Open (J5).....	13
COM5 (TSJ1).....	14
COM6 (TSJ2).....	14
eDP / LVDS (DPCN2).....	15
DB9-COM4 Pins Customization (JP1 & JP2).....	16
Expansion Slots.....	17
Installing the M.2 Module	17
Installing a Heatsink	19
Chapter 3 - BIOS Settings.....	20
Overview	20
Main.....	21
Advanced	21
RC ACPI Settings.....	22
CPU Configuration.....	22
Power & Performance.....	23
PCH-FW Configuration.....	23
Intel(R) Time Coordinated Computing.....	24
Trusted Computing.....	24
PTN3460 Configuration.....	25
IT8786 Super IO Configuration.....	25
IT8786 Super IO Configuration ▶ Serial Port 1 Configuration	26
IT8786 Super IO Configuration ▶ Serial Port 2 Configuration	26
IT8786 Super IO Configuration ▶ Serial Port 3 Configuration	27
IT8786 Super IO Configuration ▶ Serial Port 4 Configuration	27
IT8786 Super IO Configuration ▶ Serial Port 5 Configuration	28
IT8786 Super IO Configuration ▶ Serial Port 6 Configuration	28
IT8786 Hardware Monitor.....	29
Serial Port Console Redirection.....	29
Serial Port Console Redirection ▶ Console Redirection Settings	30
Network Stack Configuration.....	30
USB Power Control.....	31
Chipset.....	32

System Agent (SA) Configuration.....	32
System Agent (SA) Configuration ▶ Memory Configuration	33
PCH-IO Configuration.....	33
PCH-IO Configuration ▶ PCI Express Configuration	34
PCH-IO Configuration ▶ SATA Configuration	34
PCH-IO Configuration ▶ HD Audio Configuration	35
Security	35
Secure Boot.....	36
Boot.....	36
Save & Exit.....	37
Updating the BIOS.....	37
Notice: BIOS SPI ROM.....	37
Chapter 4 - Out Of Band Setup (* Option by project support).....	38
What's OOB (Out-Of-Band) Management.....	38
Key Features.....	38
ADN253 cBMC.....	39
Default Password Setting	40
Remote Control PC Power On/Off	46
PC Power On/Off Status Check	47
Turn On/Off PC Remotely.....	47
Perform a Timed Force Shutdown.....	48
PC Rebooting.....	48
Remote Hardware Monitor Log (Super I/O).....	49
Super I/O Log	49
How to Export Super I/O Logs From OOB.....	50
Using USB Storage / MicroSD Card to run actions.....	51
The shell scripts for USB storage.....	51
The shell scripts for MicroSD card.....	51
Formatting a microSD Card under OOB.....	51
BIOS	52
Remote BIOS Update.....	52
Remote BIOS Update (Via Teraterm).....	54
Check BIOS Set Up from USB Storage.....	55
OOB IP Address Change.....	58
SSH.....	58
Console Redirection	59

About this Manual

This manual can be retrieved from the website.

The manual is subject to change and update without notice, and may be based on editions that do not resemble your actual products. Please visit our website or contact our sales representatives for the latest editions.

Warranty

1. Warranty does not cover damages or failures that arises from misuse of the product, inability to use the product, unauthorized replacement or alteration of components and product specifications.
2. The warranty is void if the product has been subjected to physical abuse, improper installation, modification, accidents or unauthorized repair of the product.
3. Unless otherwise instructed in this user's manual, the user may not, under any circumstances, attempt to perform service, adjustments or repairs on the product, whether in or out of warranty. It must be returned to the purchase point, factory or authorized service agency for all such work.
4. We will not be liable for any indirect, special, incidental or consequential damages to the product that has been modified or altered.

About this Package

The package contains the following items. If any of these items are missing or damaged, please contact your dealer or sales representative for assistance.

- 1 ADN253 Board
- 1 Heat Sink
- 1 SATA Data with 4pin Power Cable

Note: The items are subject to change in the developing stage. The product and accessories in the package may not come similar to the information listed above. This may differ in accordance with the sales region or models in which it was sold. For more information about the standard package in your region, please contact your dealer or sales representative.

Static Electricity Precautions

It is quite easy to inadvertently damage your PC, system board, components or devices even before installing them in your system unit. Static electrical discharge can damage computer components without causing any signs of physical damage. You must take extra care in handling them to ensure against electrostatic build-up.

1. To prevent electrostatic build-up, leave the system board in its anti-static bag until you are ready to install it.
2. Wear an antistatic wrist strap.
3. Do all preparation work on a static-free surface.
4. Hold the device only by its edges. Be careful not to touch any of the components, contacts or connections.
5. Avoid touching the pins or contacts on all modules and connectors. Hold modules or connectors by their ends.



Important:

Electrostatic discharge (ESD) can damage your processor, disk drive and other components. Perform the upgrade instruction procedures described at an ESD workstation only. If such a station is not available, you can provide some ESD protection by wearing an antistatic wrist strap and attaching it to a metal part of the system chassis. If a wrist strap is unavailable, establish and maintain contact with the system chassis throughout any procedures requiring ESD protection.

Safety Precautions

- Use the correct DC / AC input voltage range.
- Unplug the power cord before removing the system chassis cover for installation or servicing. After installation or servicing, cover the system chassis before plugging in the power cord.
- There is danger of explosion if battery incorrectly replaced.
- Replace only with the same or equivalent specifications of batteries recommend by the manufacturer.
- Dispose of used batteries according to local ordinance.
- Keep this system away from humid environments.
- Make sure the system is placed or mounted correctly and stably to prevent the chance of dropping or falling may cause damage.
- The openings on the system shall not be blocked and shall be kept in distance from

other objects to make sure of proper air ventilation to protect the system from over-heating.

- Dress the cables, especially the power cord, so they will not be stepped on, in contact with high temperature surfaces, or cause any tripping hazards.
- Do not place anything on top of the power cord. Use a power cord that has been approved for use with the system and is compliant with the voltage and current ranges required by the system's electrical specifications.
- If the system is to be unused or stored for a long time, disconnect it from the power source to avoid damage by transient overvoltage.
- If one of the following occurs, consult a service personnel:
 - The power cord or plug is damaged.
 - Liquid has penetrated the system.
 - The system has been exposed to moisture.
 - The system is not working properly.
 - The system is physically damaged.
- The unit uses a three-wire ground cable which is equipped with a third pin to ground the unit and prevent electric shock. Do not defeat the purpose of this pin. If your outlet does not support this kind of plug, contact your electrician to replace the outlet.
- Disconnect the system from the electricity outlet before cleaning. Use a damp cloth for cleaning the surface. Do not use liquid or spray detergents for cleaning.
- Before connecting, make sure that the power supply voltage is correct. The device is connected to a power outlet which should be grounded connection.



The system may burn fingers while running.

Wait for 30 minutes to handle electronic parts after power off.

Chapter 1 - Introduction

► Specifications

SYSTEM	Processor	Intel Alder Lake-N Series Intel PC Client Series Intel® Processor N50 2 Cores, 1.0GHz to 3.4 GHz Intel® Processor N97 4 Cores, 2.0GHz to 2.9 GHz Intel® Processor N200 4 Cores, 1.0GHz to 3.2 GHz Intel® Core™ i3-N305 8 Cores, 1.0GHz to 3.0 GHz Intel® Embedded Series Intel® Atom® X7211E 2 Cores, 1.0GHz to 2.9 GHz Intel® Atom® X7213E 2 Cores, 1.7GHz to 2.9 GHz Intel® Atom® X7425E 4 Cores, 1.5GHz to 2.7 GHz
	Memory	8GB/16GB LPDDR5 4800 Memory down
	BIOS	AMI SPI 256Mbit (supports UEFI boot only)
	GRAPHICS	Controller Intel® UHD Graphics
	Feature	Execution Units: Up to 32 EUs 3D API: Open GL 4.6, DirectX12, Vulkan 1.2 (Windows) Mesa 3D, OpenGL 4.6, Vulkan 1.2 (Linux) Precision: FP32, FP16, INT8 Compute: OpenCL 3.0
	Display	1 x eDP(Default)/LVDS 1 x HDMI 1.4 1 x USB-C Alt. Mode, one more USB-C(opt.)
STORAGE	Internal	1 x M.2 2242/2280 M key (SATA/PCIe) 1 x SATA III 1 x eMMC (up to 128GB,optional)
EXPANSION	Interface	1 x M.2 2242/2280 M key: PCIe1/SATA 1 x M.2 2230 E Key: USB2.0/PCIe 1 x M.2 3042/3052 B key: USB3.0/USB2.0/PCIe (PCIe x2 support by project)
AUDIO	Audio Codec	ALC888S
ETHERNET	Controller	2 x Intel Ethernet controller i226 2.5GbE (support TSN) 1 x Intel Ethernet controller i210 GbE (Only Core i7/i5 supports iAMT)
REAR I/O	Ethernet	2 x 2.5GbE RJ45 1 x GbE RJ45
	Serial	1 x COM/DIO Port
	USB	3 x USB 3.2 type A 1 x USB-C 3.2
	Audio	1 x 3.5mm Line out/Mic In
	Display	1 x HDMI
	Storage	1 x MicroSD (only for OOB function update)

FRONT I/O	Serial	3 x RS232/422/485 DB9 connector
	Serial	2 x RS232
	Display	1 x 40 pin LVDS/eDP (Default eDP)
INTERNAL I/O	SATA	1 x SATA 3.0 1 x 5V SATA Power (support SATA HDD LED via front panel)
	Front Panel	1 x Front Panel
	SMBus	1 x SMBus
WATCHDOG TIMER	Output & Interval	System Reset, Programmable via Software from 1 to 255 Seconds
SECURITY	TPM	TPM 2.0 support
	Type	Wide Range 9~36VDC
	Connector	DC Jack (or vertical type 4pin connector)
POWER	Consumption	Typical: 1265UE, 12V @ 1A (12Watt) Max.: 1265UE, 12V @ 2.6A (31.2Watt)
	RTC Battery	CR2032 Coin Cell
OS SUPPORT	Microsoft	Windows 11 IoT Enterprise
	Linux	Ubuntu 22.04
MECHANISM	Dimensions	4" SBC Form Factor , 165mm (6.49") x 115mm (4.53")
	Height	PCB: 1.6mm Top Side: 16.34mm, Bottom Side: 3mm
ENVIRONMENT	Temperature	Operating: -5 to 80°C with 0.2m/s air flow (i3-N305 conditional support)
	Humidity	Storage: 5 to 90% RH
MECHANISM	Dimensions	4" SBC Form Factor 165mm (6.5") x 115mm (4.53")
STANDARDS AND CERTIFICATIONS	Certifications	CE, FCC Class B (TBD in later stage)

► Dimensions

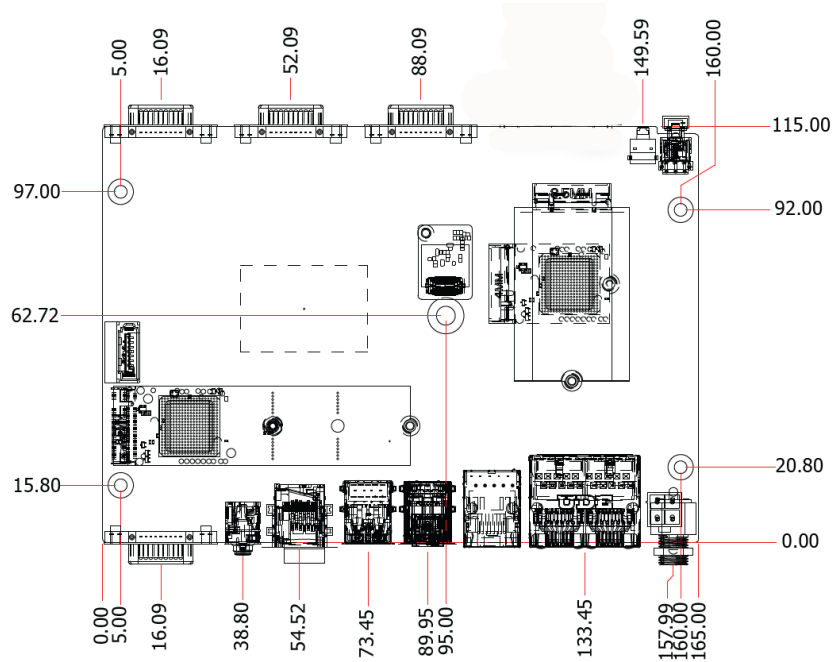

► Block Diagram

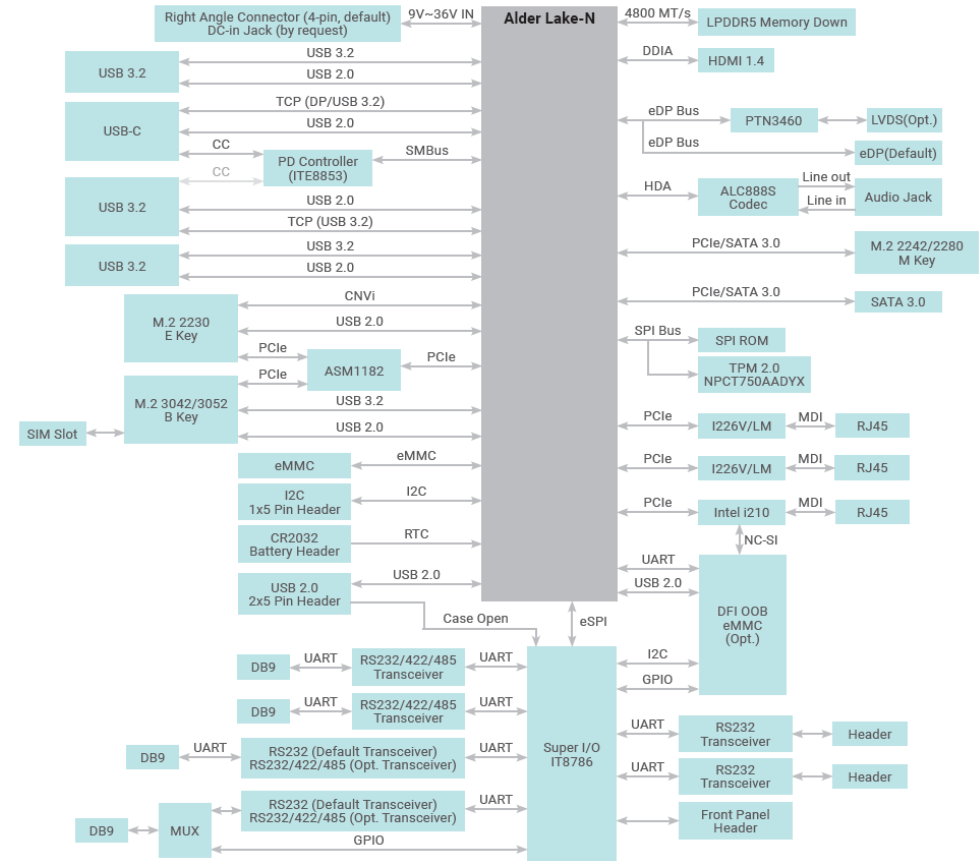

Chapter 2 - Hardware Installations

► Overview

Top View

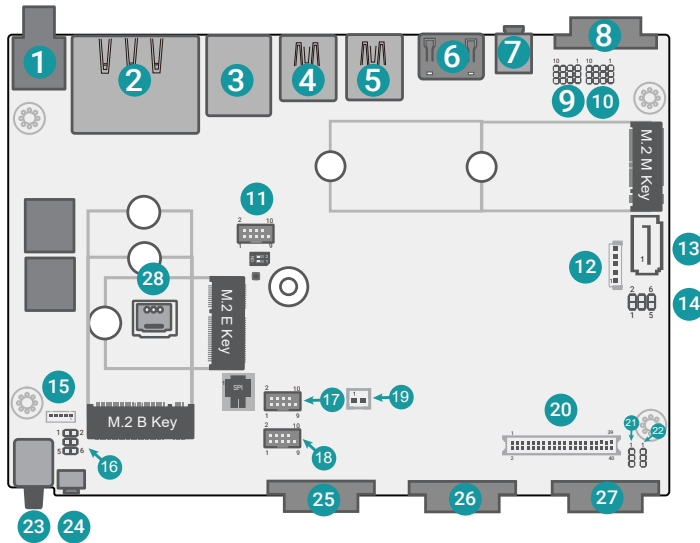

Bottom View

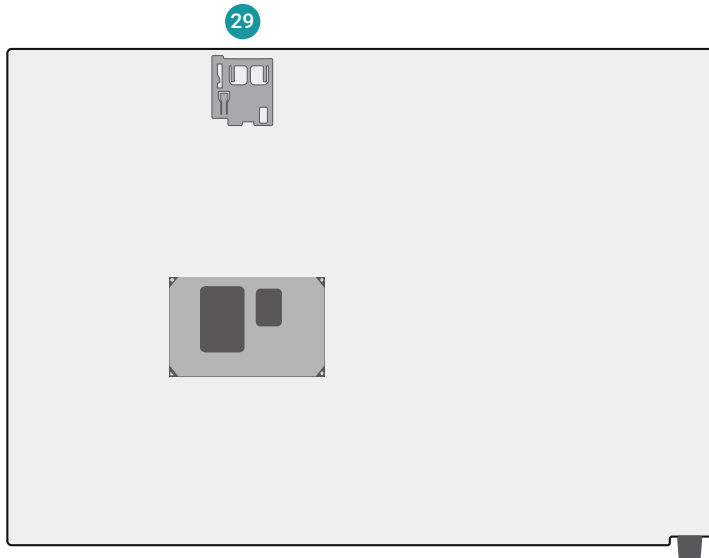

- | | |
|-----------------------------|------------------------|
| 1 DC-in | 21 INV_PWR Selection |
| 2 2.5G LAN | 22 BL_ON_OFF Selection |
| 3 LAN | 23 Power Button |
| 4 ▲USB3.2
▼USB Type-C | 24 Reset Button |
| 5 USB3.2 | 25 COM1 |
| 6 HDMI | 26 COM2 |
| 7 Audio | 27 COM3 |
| 8 COM4/DIO | 28 SIM Card Slot |
| 9 COM4/DIO Selection (JP2) | 29 MicroSD Card Slot |
| 10 COM4/DIO Selection (JP1) | |
| 11 USB2.0 / Case Open | |
| 12 SATA Power | |
| 13 SATA | |
| 14 VCC_PANEL Selection | |
| 15 I2C Header | |
| 16 Front Panel | |
| 17 COM5 | |
| 18 COM6 | |
| 19 RTC Battery | |
| 20 eDP / LVDS | |

► **Jumper Settings**

BL_ON_OFF Selection (DPJP1)

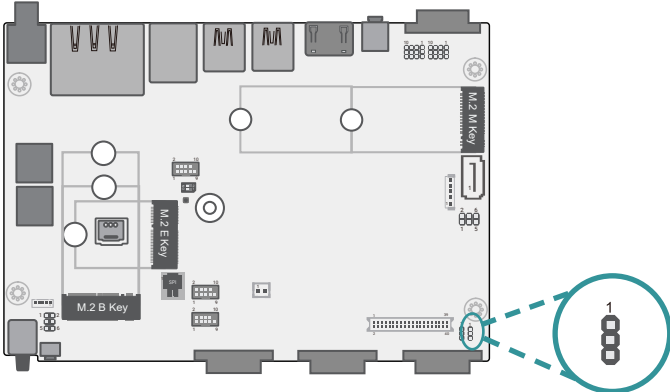

1

■ 1-2 On: 3.3V

1

■ 2-3 On : 5V

INV_PWR Selection (DPJP2)

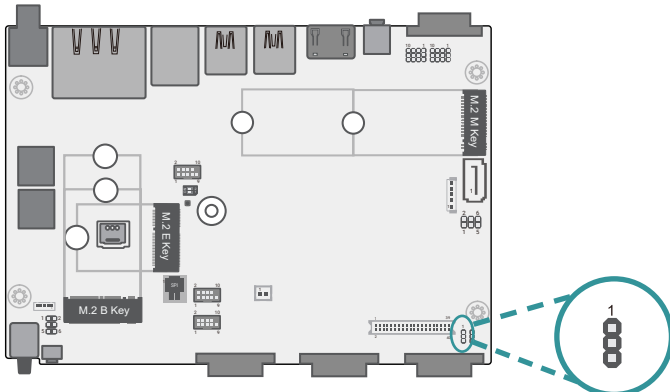

1

■ 1-2 On: 12V

1

■ 2-3 On: 5V

VCC_PANEL Selection (DPJP3)

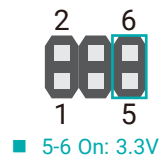
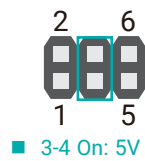
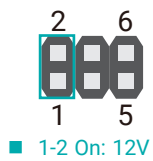
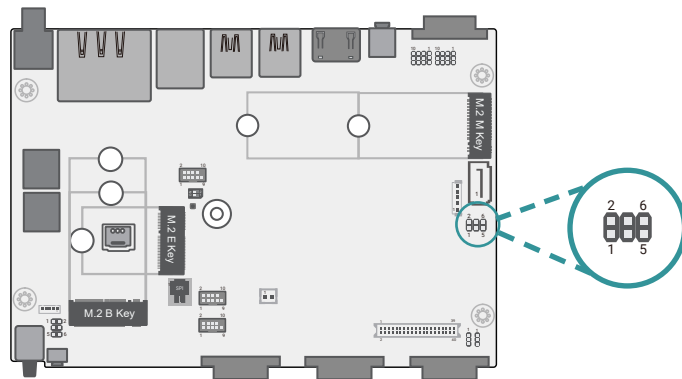

COM4/DIO Selection (JP1 & JP2)

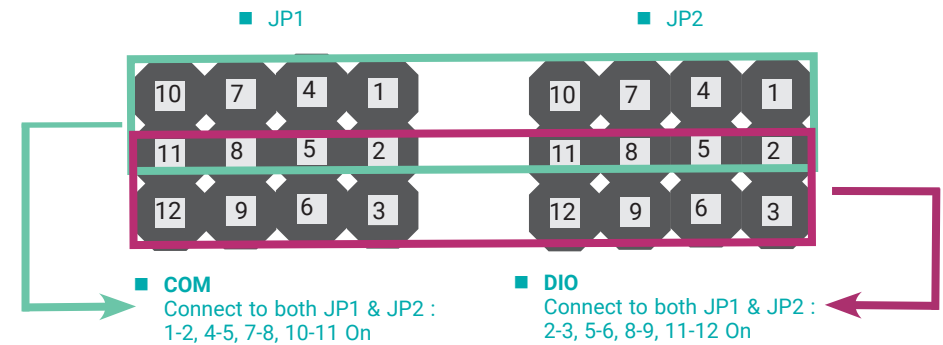
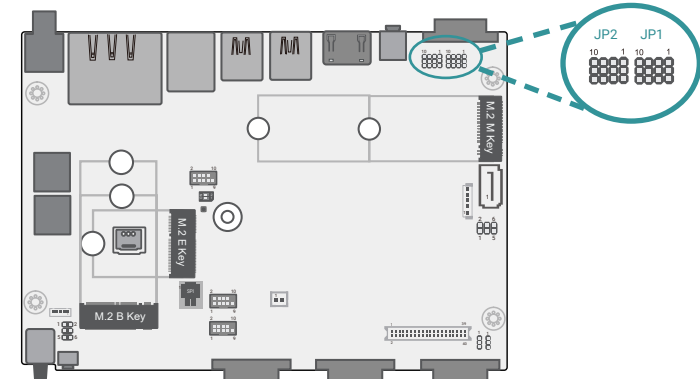

► **Pin Assignment**

I2C Header (J8)

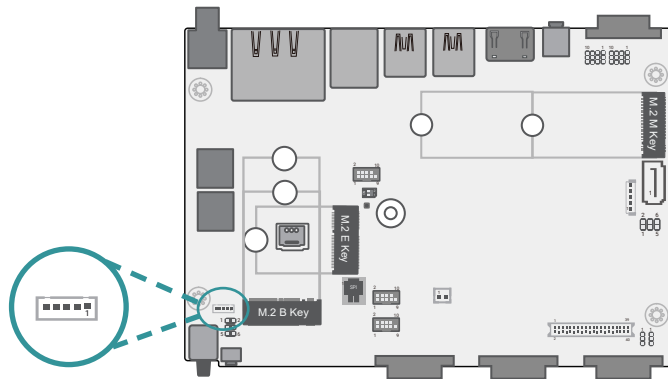

Pin	Assignment
1	3V3
2	GND
3	I2C_SCL
4	I2C_SDA
5	I2C_INT

SATA Power (CN11)

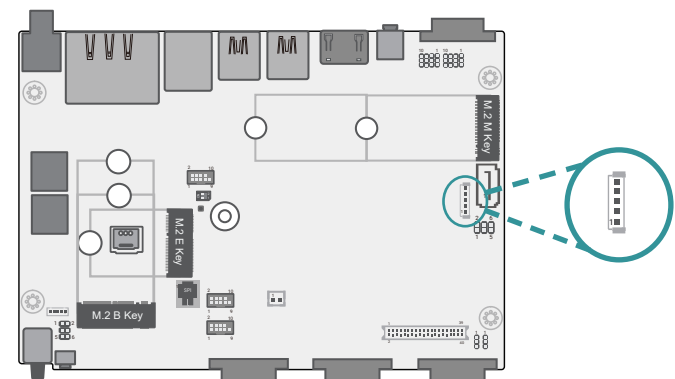

Pin	Assignment
1	5V
2	5V
3	12V
4	GND
5	GND

Front Panel (JP4)

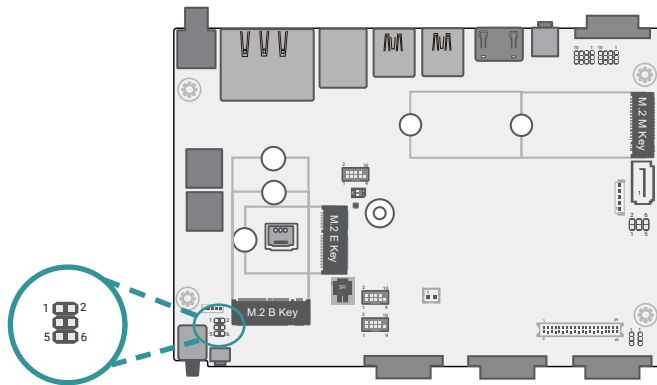

Pin	Assignment	Pin	Assignment
1	PWR_BTN	2	3V3
3	GND	4	SUS_LED#
5	SYS_RST	6	HD_LED#

USB2.0 / Case Open (J5)



Pin	Assignment	Pin	Assignment
1	NC	2	5V
3	NC	4	USB2_N
5	NC	6	USB2_P
7	GND	8	GND
9	CASEOPEN-	10	NC

COM5 (TSJ1)

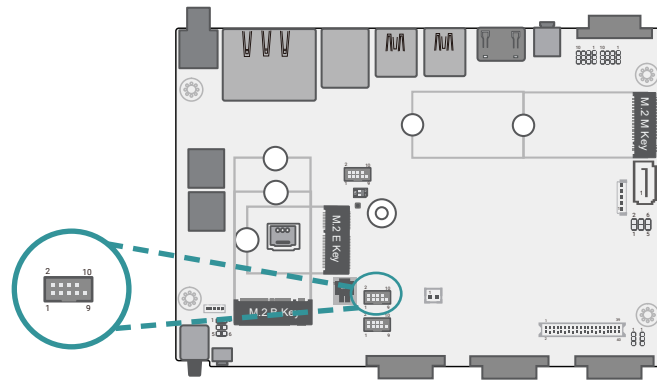

Pin	Assignment	Pin	Assignment
1	MDCD-	2	MSIN-
3	MSO-	4	MDTR-
5	GND	6	MDSR-
7	MRTS-	8	MCTS-
9	MRI-	10	NC

COM6 (TSJ2)

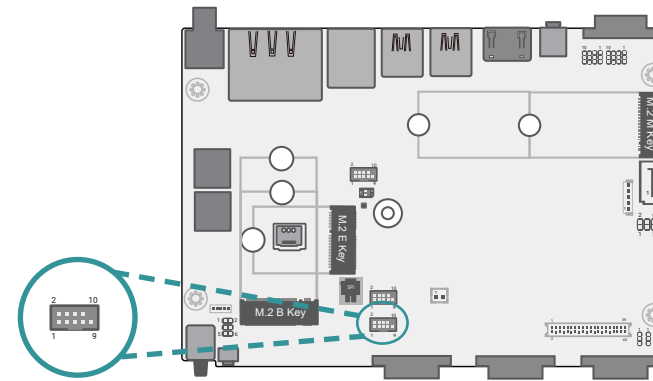

Pin	Assignment	Pin	Assignment
1	MDCD-	2	MSIN-
3	MSO-	4	MDTR-
5	GND	6	MDSR-
7	MRTS-	8	MCTS-
9	MRI-	10	NC

eDP / LVDS (DPCN2)

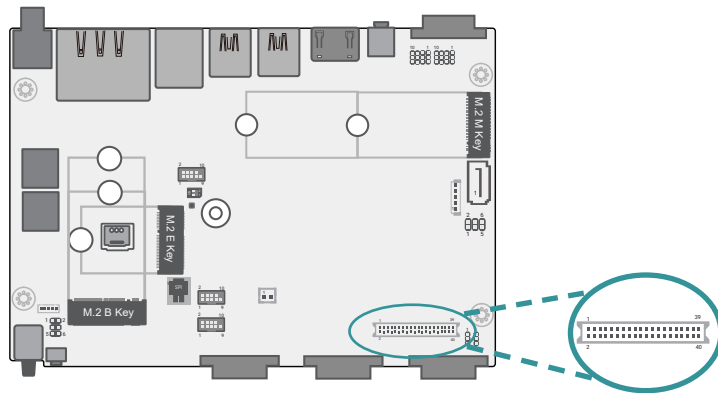

Pin	Assignment	Pin	Assignment
1	LVDS_A_LANE3_P	2	LVDS_B_LANE3_P
3	LVDS_A_LANE3_N	4	LVDS_B_LANE3_N
5	GND	6	GND
7	LVDS_A_LANE2_P	8	LVDS_B_LANE2_P
9	LVDS_A_LANE2_N	10	LVDS_B_LANE2_N
11	GND	12	GND
13	LVDS_A_LANE1_P	14	LVDS_B_LANE1_P / eDP_LANE1_P
15	LVDS_A_LANE1_N	16	LVDS_B_LANE1_N / eDP_LANE1_N
17	GND	18	GND
19	LVDS_A_LANE0_P	20	LVDS_B_LANE0_P / eDP_LANE0_P
21	LVDS_A_LANE0_N	22	LVDS_B_LANE0_N / eDP_LANE0_N
23	GND	24	GND
25	LVDS_A_CLK_P	26	LVDS_B_CLK_P / eDP_CLK_P
27	LVDS_A_CLK_N	28	LVDS_B_CLK_N / eDP_CLK_P
29	GND	30	GND
31	LVDS_DDC_CLK	32	eDP_HPD
33	LVDS_DDC_DATA	34	BL_ON_OFF
35	GND	36	LVDS_3V3 (1A)
37	INV_PWR (5V/12V, 2A)	38	DIMMING
39		40	PANEL_PWR (3.3V/5V/12V, 1A)

DB9-COM4 Pins Customization (JP1 & JP2)

Connect to JP1 (pin 2, ,5, 8, 11) & JP2 (pin 2, ,5, 8, 11) if there is internal signal communication request via DB9-COM4 connector without I/O shield changed.

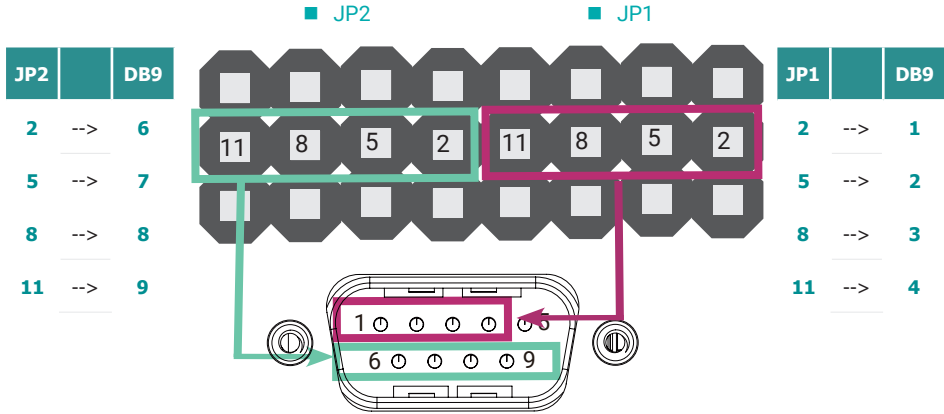
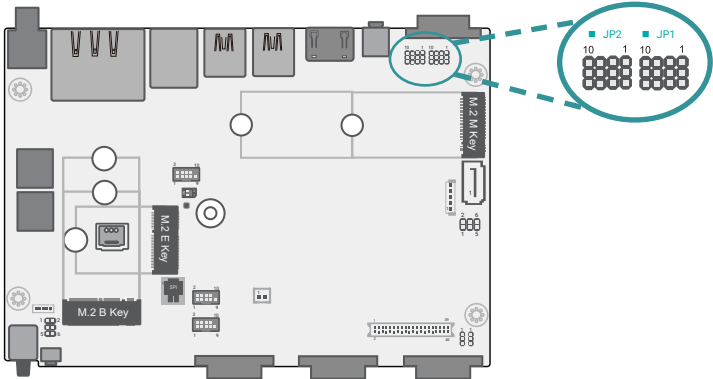

► **Expansion Slots**

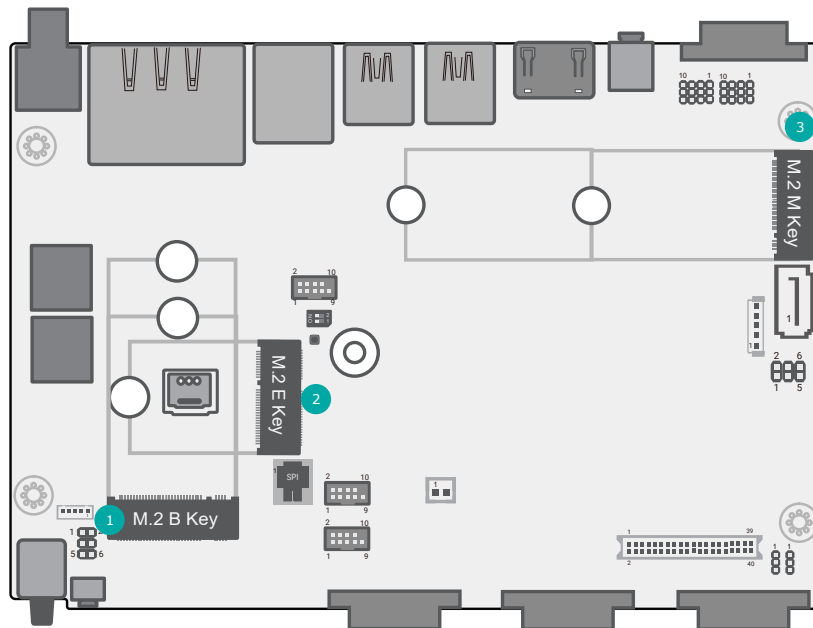

- 1 M.2 B-Key
- 2 M.2 E-Key
- 3 M.2 M-Key

Installing the M.2 Module

Before installing the M.2 module into the M.2 socket, please make sure that the following safety cautions are well-attended.

1. Make sure the PC and all other peripheral devices connected to it has been powered down.
2. Disconnect all power cords and cables.
3. Locate the M.2 socket on the system board
4. Make sure the notch on card is aligned to the key on the socket.
5. Make sure the standoff screw is removed from the standoff.

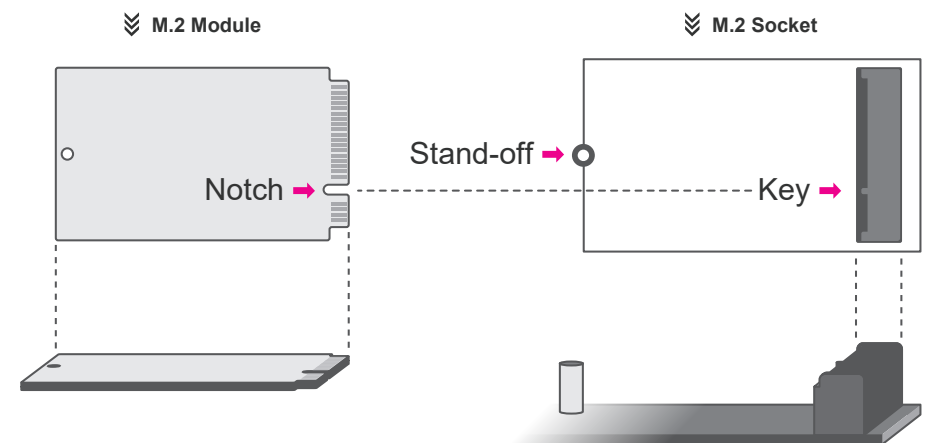

Please follow the steps below to install the card into the socket.

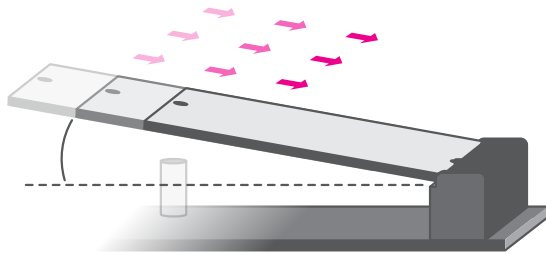

Step 1:
Insert the card into the socket at an angle while making sure the notch and key are perfectly aligned.

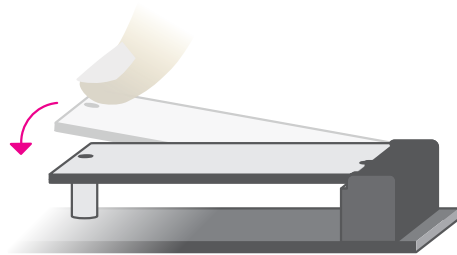

Step 2:
Press the end of the card far from the socket down until against the stand-off.

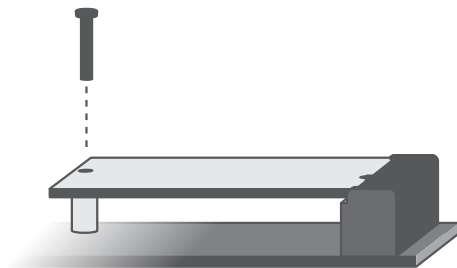

Step 3:
Screw tight the card onto the stand-off with a screw driver and a stand-off screw until the gap between the card and the stand-off closes up. The card should be lying parallel to the board when it's correctly mounted.

► Installing a Heatsink

Step 1:

On the bottom of the heatsink, you will see the alignment marks to paste three thermal pads and one thermal dissipation copper block.

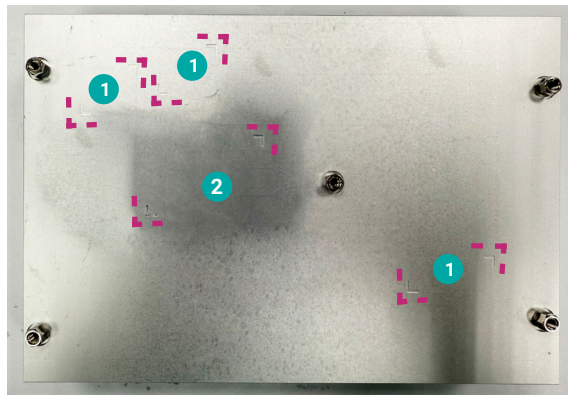

- 1 For thermal pad
- 2 For thermal dissipation copper block

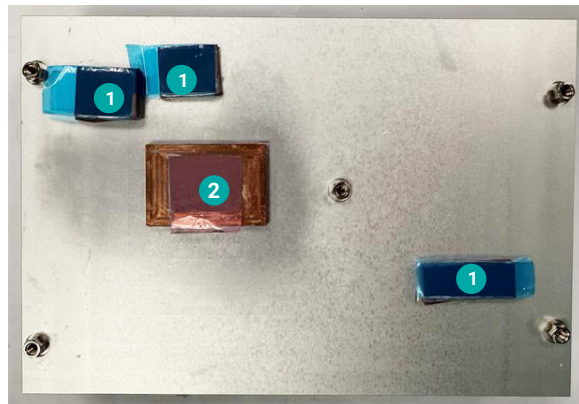

Before you place the heat sink on the CPU, you must apply a thermal paste onto a copper block and paste on the position 2. (See the photo above.)
Make sure to peel off all the plastic films from every thermal pad and the copper block.

Step 2:

Place the motherboard on top of the heatsink. CPU should be facing the interface metal side of the heat sink.

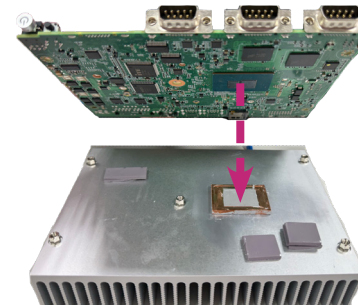

Note:
Make sure all the plastic films are removed.

There are five mounting holes of the motherboard circled in red. Make sure the mounting holes are aligned with the heatsink. To prevent possible damage to the motherboard, we suggest you to first fasten the mounting hole (No.3) with a screw. Then move on to the mounting hole : No.1 ->No.5 ->No.4 ->No.2 (Please see the photo below)
Do not screw each mounting hole tight fully and just enough to hold the motherboard in place. Once the screws are all half locked and seated, you can fasten all the mounting holes tight.

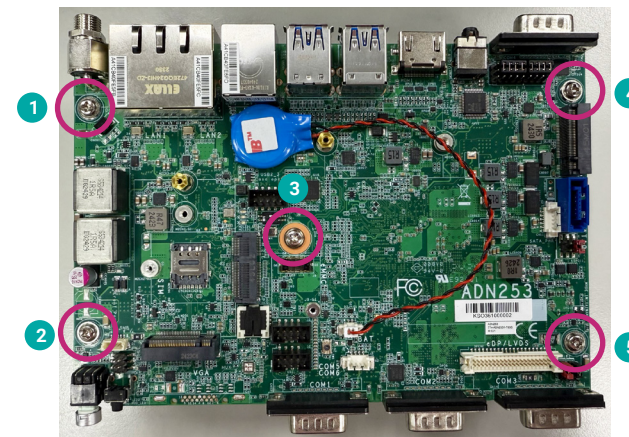

Note:
Do not use excessive force or place direct pressure on the board. It affects the board's performance and may damage the motherboard.

Chapter 3 - BIOS Settings

► Overview

The BIOS is a program that takes care of the basic level of communication between the CPU and peripherals. It contains codes for various advanced features found in this system board. The BIOS allows you to configure the system and save the configuration in a battery-backed CMOS so that the data retains even when the power is off. In general, the information stored in the CMOS RAM of the EEPROM will stay unchanged unless a configuration change has been made such as a hard drive replaced or a device added. It is possible that the CMOS battery will fail causing CMOS data loss. If this happens, you need to install a new CMOS battery and reconfigure the BIOS settings.



Note:

The BIOS is constantly updated to improve the performance of the system board; therefore the BIOS screens in this chapter may not appear the same as the actual one. These screens are for reference purpose only.

Default Configuration

Most of the configuration settings are either predefined according to the Load Optimal Defaults settings which are stored in the BIOS or are automatically detected and configured without requiring any actions. There are a few settings that you may need to change depending on your system configuration.

Entering the BIOS Setup Utility

The BIOS Setup Utility can only be operated from the keyboard and all commands are keyboard commands. The commands are available at the right side of each setup screen.

The BIOS Setup Utility does not require an operating system to run. After you power up the system, the BIOS message appears on the screen and the memory count begins. After the memory test, the message "Press DEL to run setup" will appear on the screen. If the message disappears before you respond, restart the system or press the "Reset" button. You may also restart the system by pressing the <Ctrl> <Alt> and keys simultaneously.

Legends

Keys	Function
Right / Left arrow	Move the highlight left or right to select a menu
Up / Down arrow	Move the highlight up or down between submenus or fields
<Enter>	Enter the highlighted submenu
+ (plus key)/F6	Scroll forward through the values or options of the highlighted field
- (minus key)/F5	Scroll backward through the values or options of the highlighted field
<F1>	Display general help
<F2>	Display previous values
<F7>	Popup Boot Device List
<F9>	Optimized defaults
<F10>	Save and Exit
<Esc>	Return to previous menu

Scroll Bar

When a scroll bar appears to the right of the setup screen, it indicates that there are more available fields not shown on the screen. Use the up and down arrow keys to scroll through all the available fields.

Submenu

When "►" appears on the left of a particular field, it indicates that a submenu which contains additional options are available for that field. To display the submenu, move the highlight to that field and press <Enter>.

► Main

The Main menu is the first screen that you will see when you enter the BIOS Setup Utility.

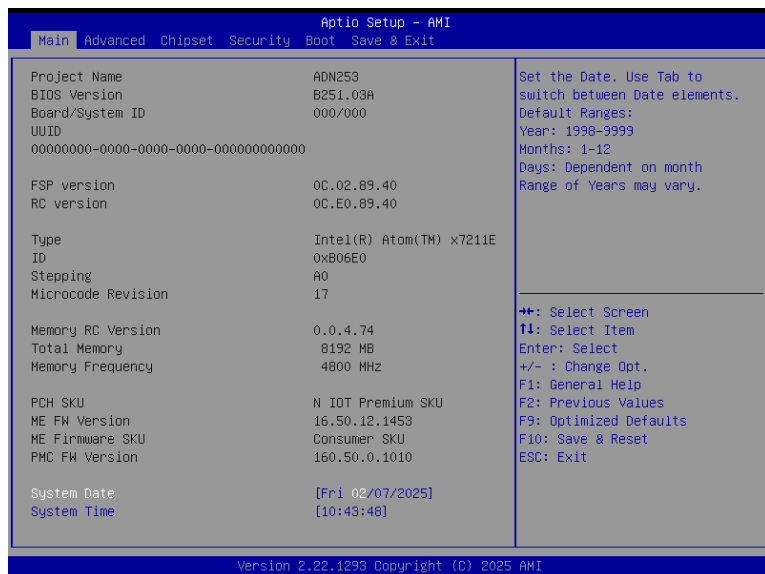

System Date

The date format is <month>, <date>, <year>. Press "Tab" to switch to the next field and press "-" or "+" to modify the value.

System Time

The time format is <hour>, <minute>, <second>. The time is based on the 24-hour military-time clock. For example, 1 p.m. is 13:00:00. Hour displays hours from 00 to 23. Minute displays minutes from 00 to 59. Second displays seconds from 00 to 59.

► Advanced

The Advanced menu allows you to configure your system for basic operation. Some entries are defaults required by the system board, while others, if enabled, will improve the performance of your system or let you set some features according to your preference.



Important:
Setting incorrect field values may cause the system to malfunction.

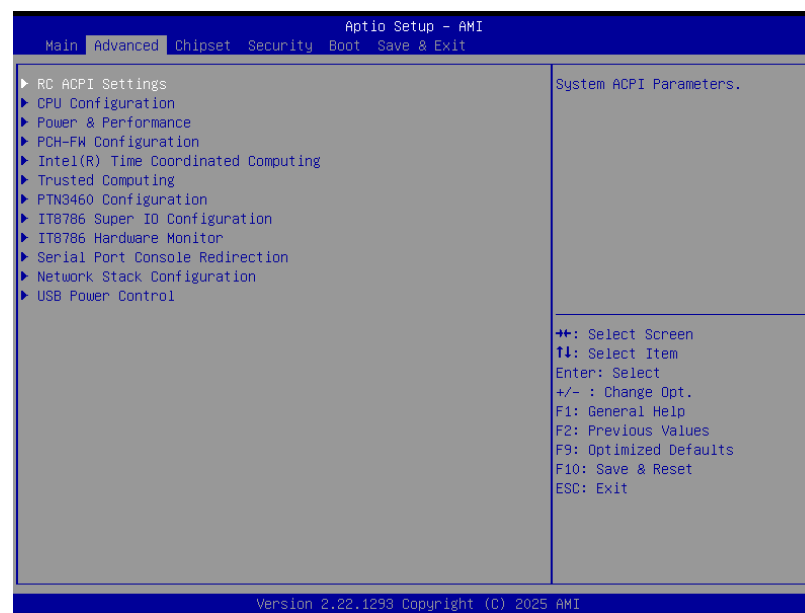

► Advanced

RC ACPI Settings

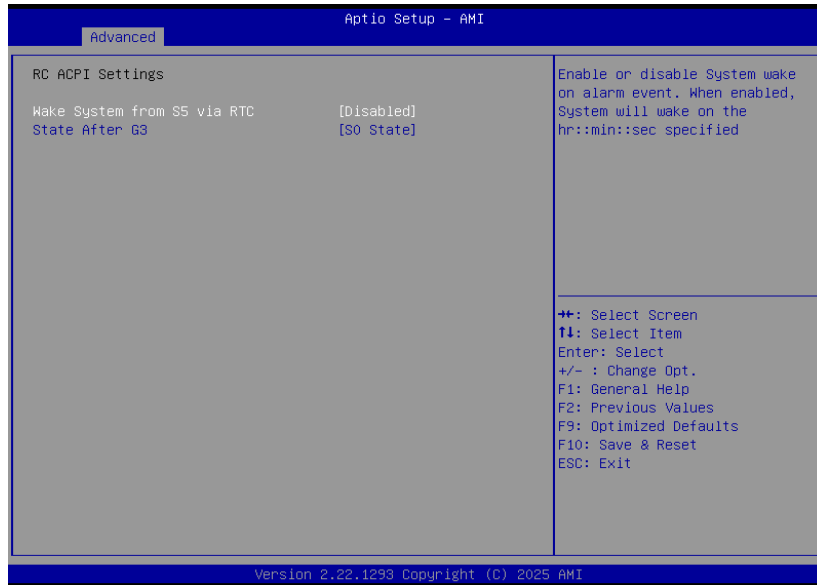

Wake system from S5 via RTC

When Enabled, the system will automatically power up at a designated time every day. Once it's switched to [Enabled], please set up the time of day – hour, minute, and second – for the system to wake up.

State After G3

Select between S0 State, and S5 State. This field is used to specify what state the system is set to return to when power is re-applied after a power failure (G3 state).

- **S0 State** The system automatically powers on after power failure.
- **S5 State** The system enter soft-off state after power failure. Power-on signal input is required to power up the system.

► Advanced

CPU Configuration

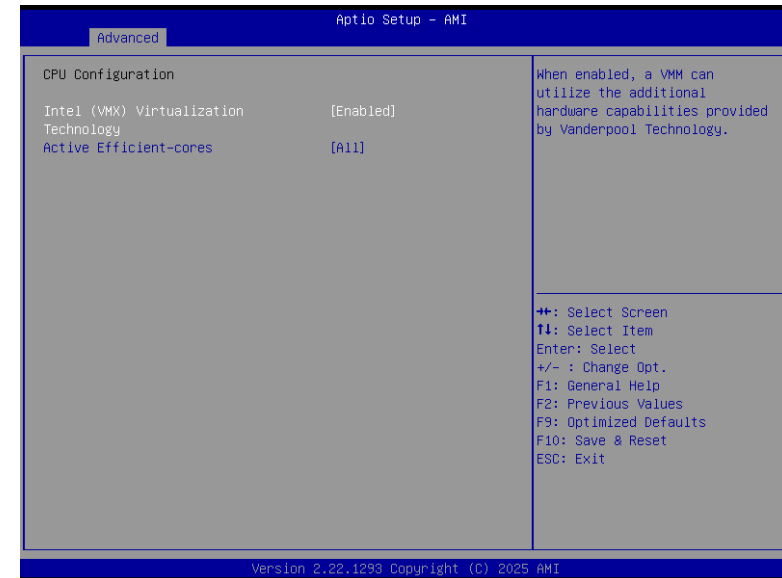

Intel (VMX) Virtualization Technology

When this field is set to Enabled, the VMM can utilize the additional hardware capabilities provided by Vanderpool Technology.

Active Efficient-cores : [All, 7,6,5,4,3,2,1]

Number of E-cores to enable in each processor package.
 Note: Number of Cores and E-cores are looked at together. When both are {0,0}, the system will enable all cores.

▶ Advanced

Power & Performance

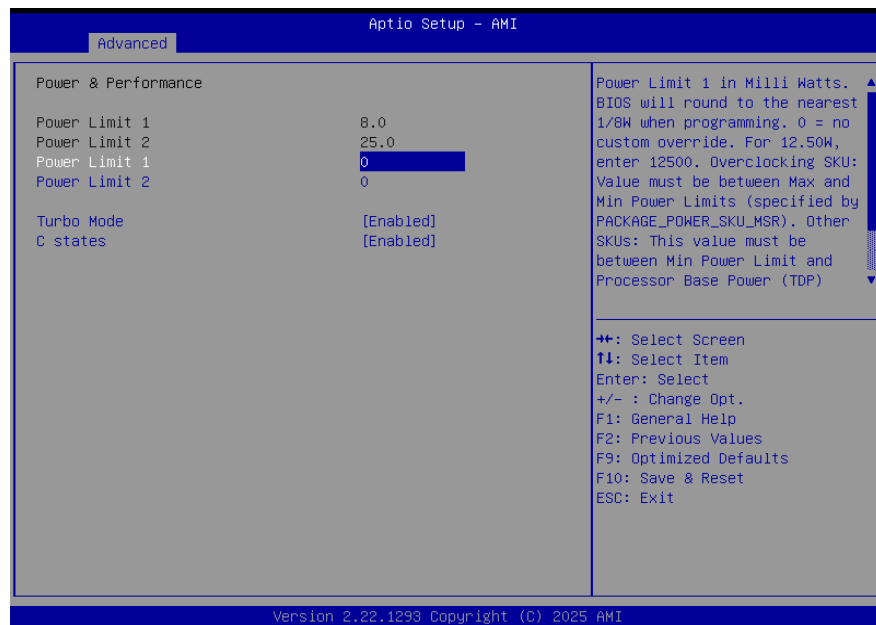

Turbo Mode

Enable or disable turbo mode of the processor. This field will only be displayed when EIST is enabled.

C states

Enable or disable CPU Power Management. It allows CPU to enter "C states" when it's idle and nothing is executing.

▶ Advanced

PCH-FW Configuration

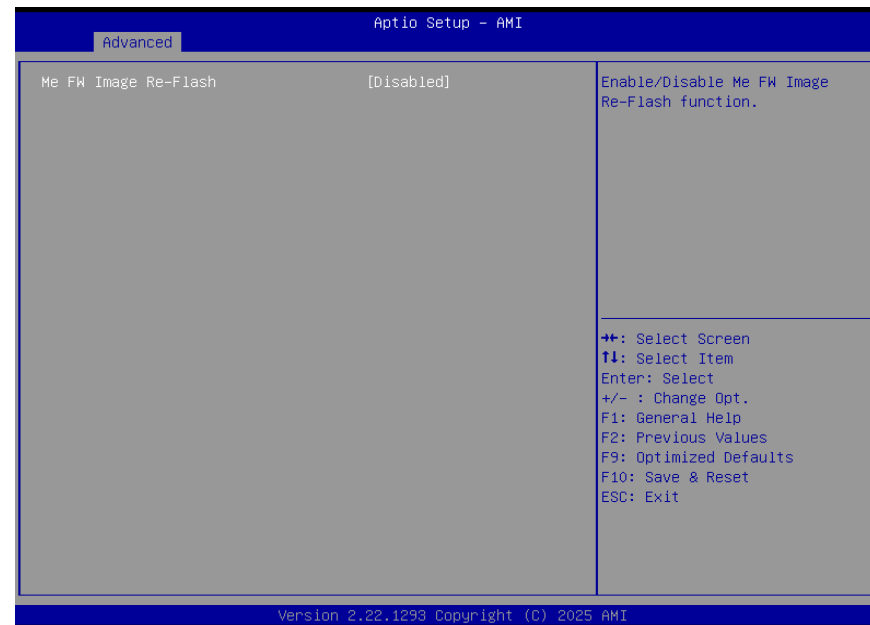

ME FW Image Re-Flash

Enable/Disable Me FW Image Re-Flash function.

▶ Advanced

Intel(R) Time Coordinated Computing

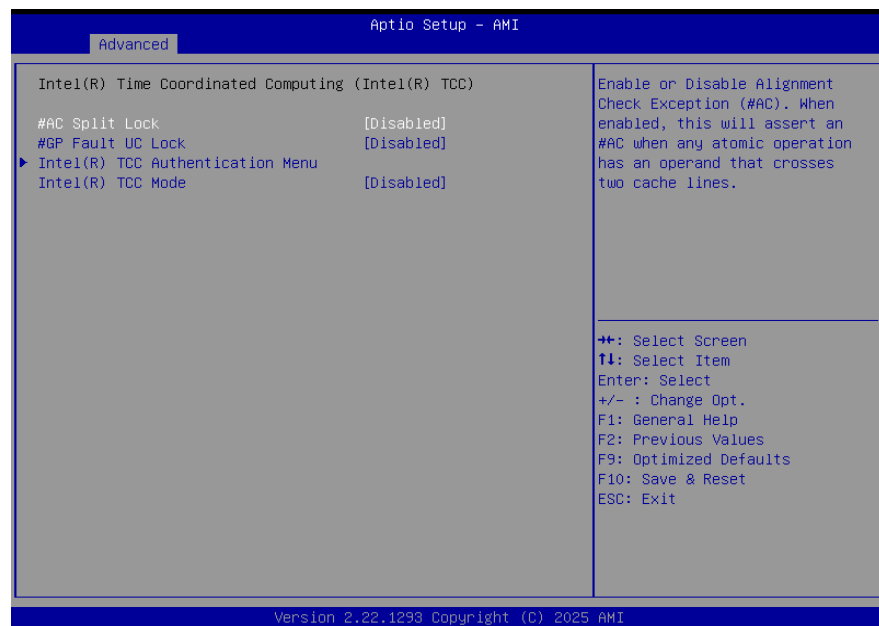

#AC Split Lock

Enable or Disable Alignment Check Exception (#AC). When enabled, this will assert an #AC when any atomic operation has an operand that crosses two cache lines.

#GP Fault UC Lock

Enable or Disable GP Fault Exception (GP#). When enabled, this will assert an GP# when encountering a Lock to un-cacheable memory before the bus is locked.

Intel(R) TCC Authentication Menu

Intel(R) TCC Authentication Menu options

Intel(R) TCC Mode

Enable or Disable Intel(R) TCC Mode.

When enabled, this will modify system settings to improve real-time performance. The full list of settings and their current state are displayed below when Intel (R) TCC mode is enabled.

▶ Advanced

Trusted Computing



Security Device Support

This field is used to enable or disable BIOS support for the security device such as an TPM 2.0 to achieve hardware-level security via cryptographic keys.

Pending operation

To clear the existing TPM encryption, select "TPM Clear" and restart the system. This field is not available when "Security Device Support" is disabled.

▶ Advanced

PTN3460 Configuration

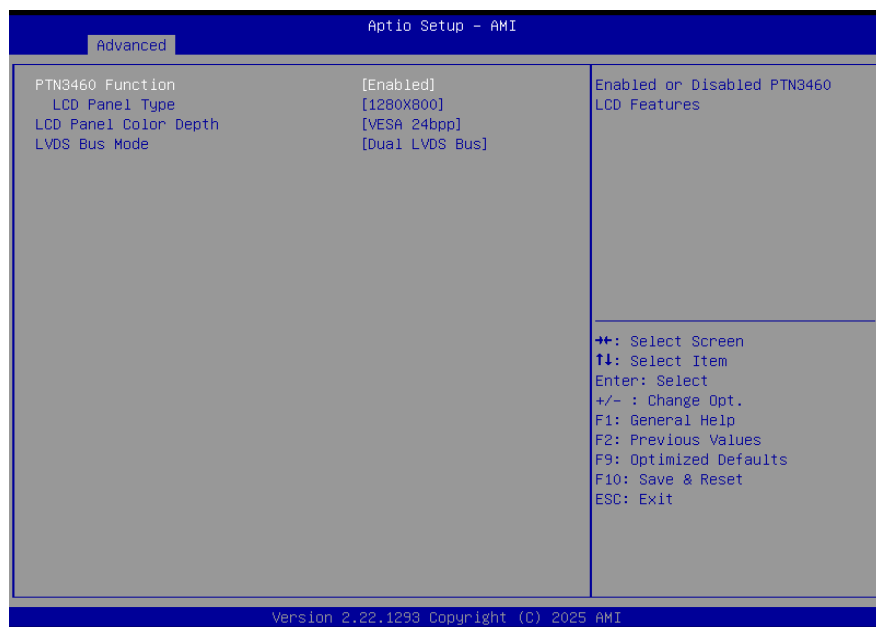

PTN3460 Function

Enable or Disable PTN3460 LCD Features. When this field is disabled, the following fields will remain hidden.

LCD Panel Type

Select the resolution of the LCD Panel – 800X480, 800X600, 1024X768, 1366X768, 1280X1024, 1920X1080, or 1920X1200.

LCD Panel Color Depth

Select the color depth of the LCD Panel – VESA 24bpp, JEIDA 24bpp, VESA and JEIDA 18 bpp.

LVDS Bus Mode

Select PTN3460 LVDS BUS Mode : Single LVDS Bus /Dual LVDS Bus



Note:

The configuration must match the specifications of your LCD Panel in order for the LCD Panel to display properly.

▶ Advanced

IT8786 Super IO Configuration

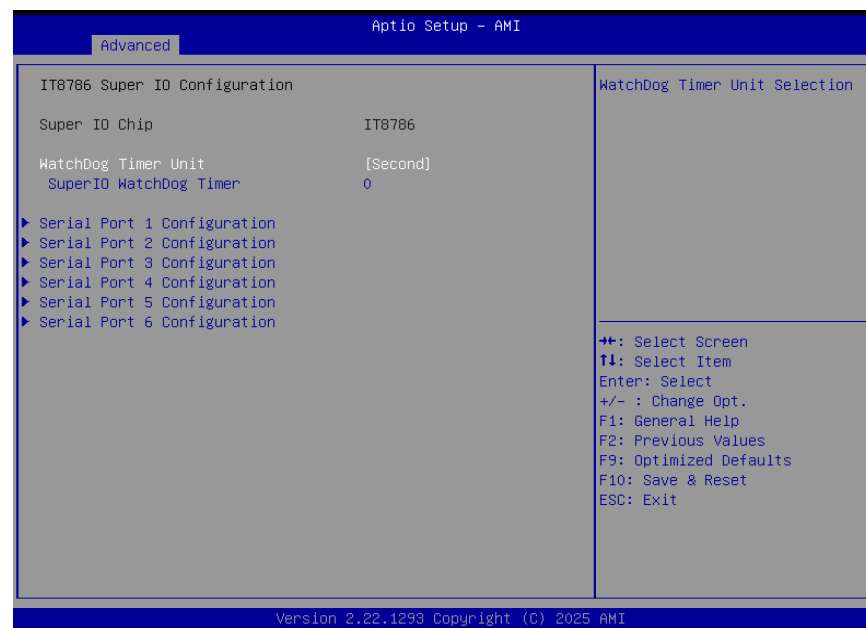

WatchDog Timer Unit

Select WatchDog Timer Unit – Second or Minute.

SuperIO WatchDog Timer

Set SuperIO WatchDog Timer Timeout value. The range is from 0 (disabled) to 255.



Note:

The sub-menus are detailed in following sections.

▶ Advanced

IT8786 Super IO Configuration ▶ Serial Port 1 Configuration

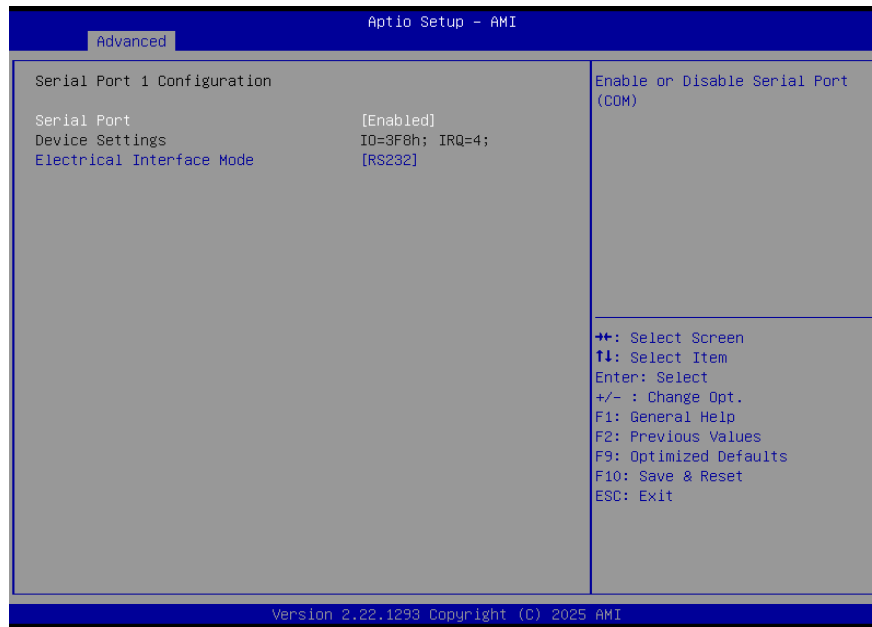

Serial Port

Enable or disable serial port.

▶ Advanced

IT8786 Super IO Configuration ▶ Serial Port 2 Configuration

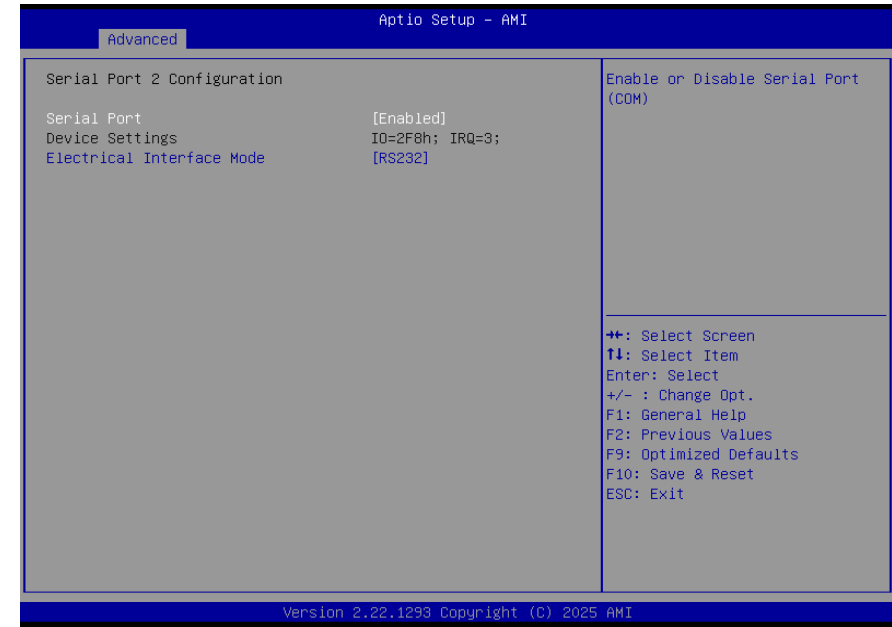

Serial Port

Enable or disable serial port.

▶ Advanced

IT8786 Super IO Configuration ▶ Serial Port 3 Configuration

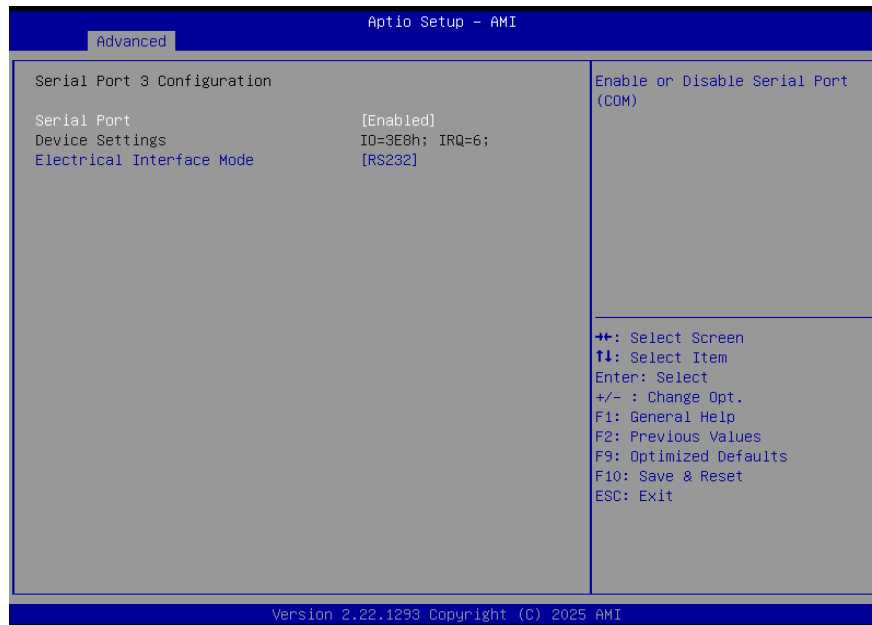

Serial Port

Enable or disable serial port.

▶ Advanced

IT8786 Super IO Configuration ▶ Serial Port 4 Configuration

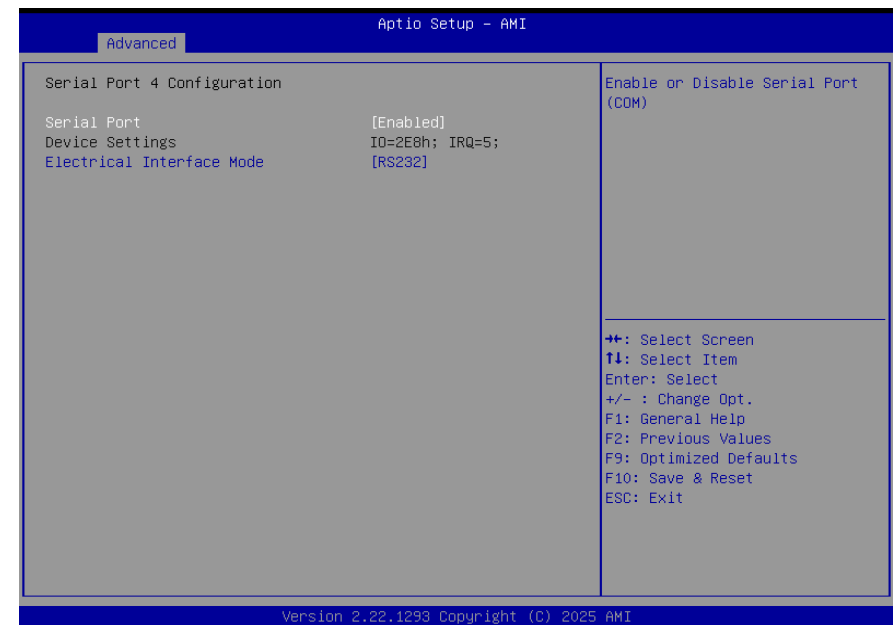

Serial Port

Enable or disable serial port.

▶ Advanced

IT8786 Super IO Configuration ▶ Serial Port 5 Configuration



Serial Port

Enable or disable serial port.

▶ Advanced

IT8786 Super IO Configuration ▶ Serial Port 6 Configuration

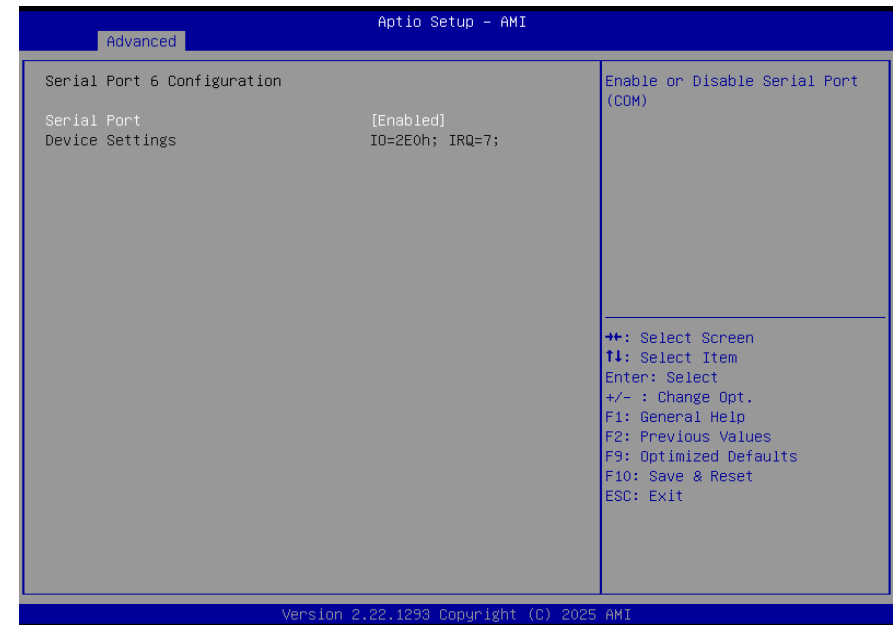

Serial Port

Enable or disable serial port.

▶ Advanced

IT8786 Hardware Monitor

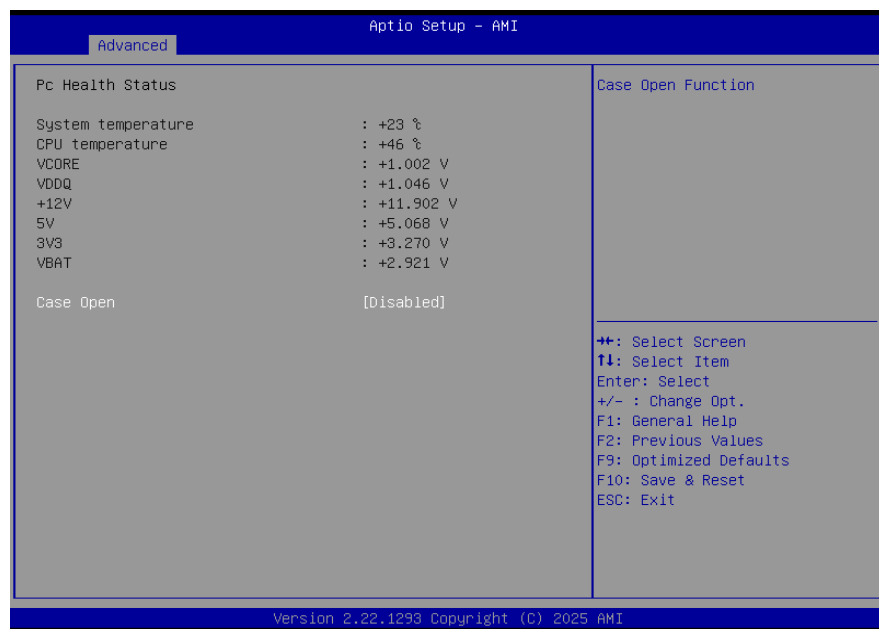

This section displays the system's health information, i.e. voltage readings, CPU and system temperatures, and fan speed readings

Case Open

Enable or disable the case open detection function.

▶ Advanced

Serial Port Console Redirection

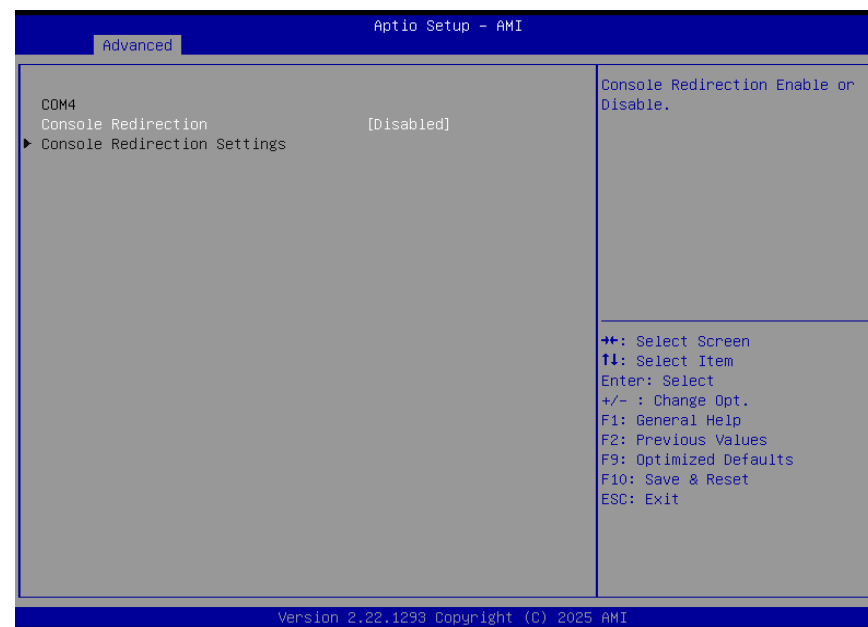

► Advanced

Serial Port Console Redirection ► Console Redirection Settings

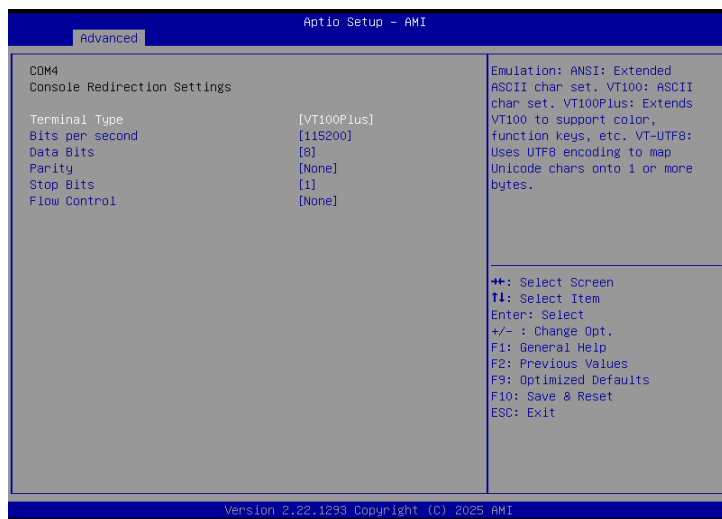

Configure the serial settings of the current COM port.

Terminal Type

Select terminal type: VT100, VT100+, VT-UTF8 or ANSI.

Bits per second

Select serial port transmission speed: 9600, 19200, 38400, 57600 or 115200.

Data Bits

Select data bits: 7 bits or 8 bits.

Parity

Select parity bits: None, Even, Odd, Mark or Space.

Stop Bits

Select stop bits: 1 bit or 2 bits.

Flow Control

Select flow control type: None or Hardware RTS/CTS. Flow Control is for RS485 mode and is only supported by Serial Port 1 (COM1).

► Advanced

Network Stack Configuration



Network Stack

Enable or disable UEFI network stack. The following fields will appear when this field is enabled.

IPv4 PXE Support

Enable or disable IPv4 PXE boot support. If disabled, IPv4 PXE boot support will not be available.

IPv6 PXE Support

Enable or disable IPv6 PXE boot support. If disabled, IPv6 PXE boot support will not be available.

PXE boot wait time

Set the wait time in seconds to press ESC key to abort the PXE boot. Use either +/- or numeric keys to set the value.

Media detect count

Set the number of times the presence of media will be checked. Use either +/- or numeric keys to set the value.

► **Advanced**

USB Power Control

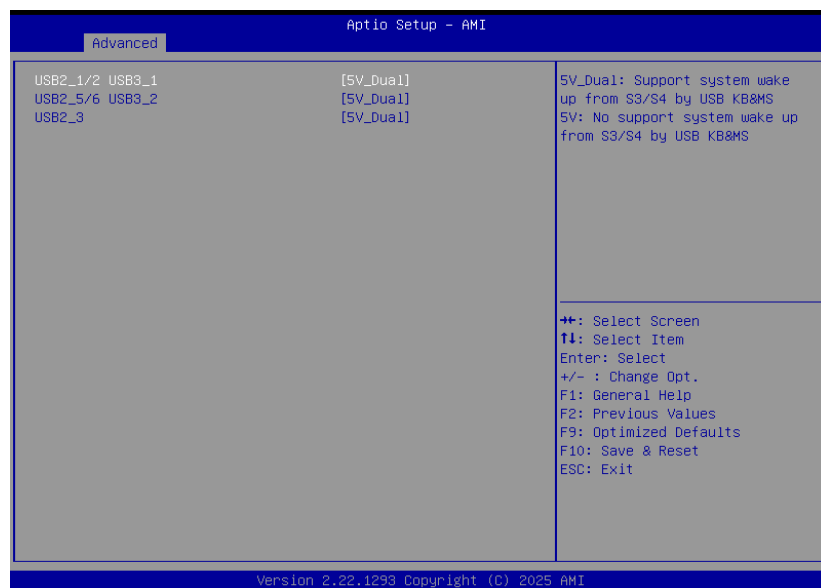

Server CA Configuration

5_Dual: Support system wake up from S3/S4 by USB KB&MS

5V: No support system wake up from S3/S4 by USB KB&MS

► Chipset



► Chipset

System Agent (SA) Configuration



Please select a submenu and press Enter. The submenus are detailed in the following pages.

► Chipset

System Agent (SA) Configuration ► Memory Configuration



In-Band ECC Support

Enable/Disable In-Band ECC.
Will be enabled if memory has symmetric configuration

► Chipset

PCH-IO Configuration



PCI Express Configuration

PCI Express Configuration Settings

SATA Configuration

SATA Device Options Settings

HD Audio Configuration

HD Audio Subsystem Configuration Settings

► Chipset

PCH-IO Configuration ► PCI Express Configuration

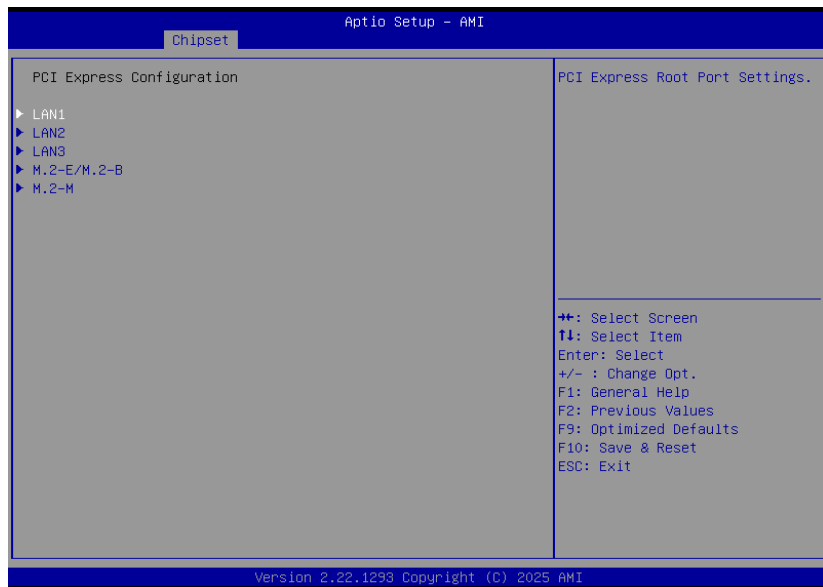

Select one of the PCI Express channels and press enter to configure the following settings.

LAN 1,2,3 M.2-B, M.2-E, M.2-M

Control the PCI Express Root Port.

► Chipset

PCH-IO Configuration ► SATA Configuration



SATA Controller(s)

This field is used to enable or disable the Serial ATA controller.

SATA Mode Selection

The mode selection determines how the SATA controller(s) operates.

- **AHCI** This option allows the Serial ATA controller(s) to use AHCI (Advanced Host Controller Interface).

Ports

Enable or disable the Serial ATA port.

► Chipset

PCH-IO Configuration ► HD Audio Configuration

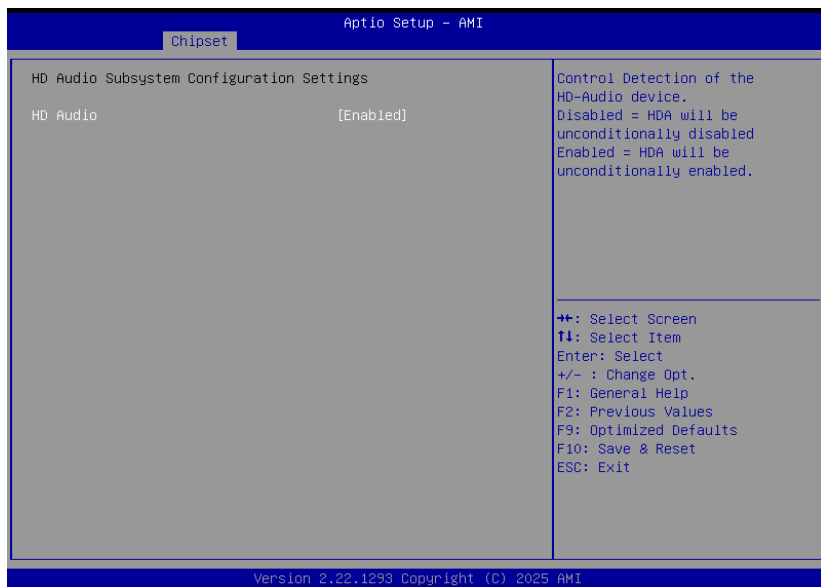

HD Audio

Control the detection of the HD Audio device.

- **Disabled** HDA will be unconditionally disabled.
- **Enabled** HDA will be unconditionally enabled.

► Security

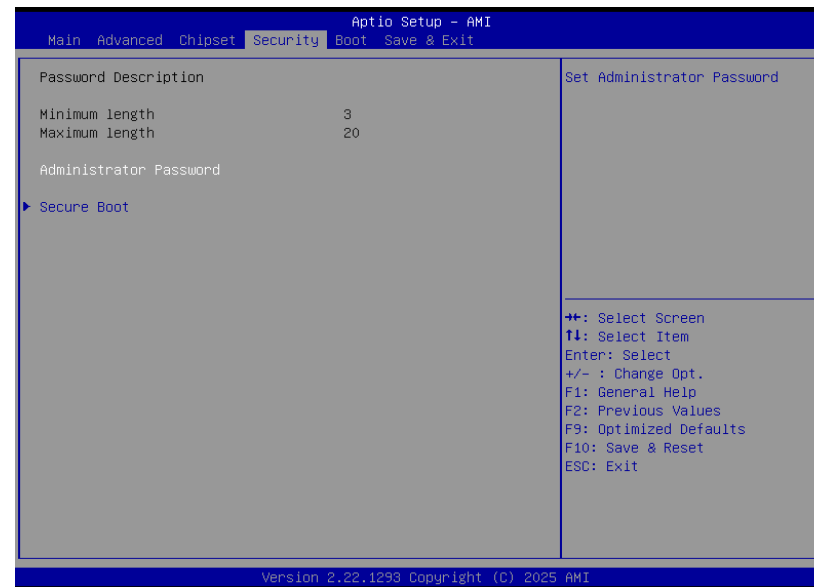

Administrator Password

Set the administrator password. To clear the password, input nothing and press enter when a new password is asked. Administrator Password will be required when entering the BIOS.

► Security

Secure Boot



Secure Boot

The Secure Boot store a database of certificates in the firmware and only allows the OSes with authorized signatures to boot on the system. To activate Secure Boot, please make sure that “Secure Boot” is “[Enabled]”, Platform Key (PK) is enrolled, “System Mode” is “User”, and CSM is disabled. After enabling/disabling Secure Boot, please save the configuration and restart the system. When configured and activated correctly, the Secure Boot status will be “Active”.

Secure Boot Mode

Select the secure boot mode – Standard or Custom. When set to Custom, the following fields will be configurable for the user to manually modify the key database.

Restore Factory Keys

Force system to User Mode. Load OEM-defined factory defaults of keys and databases onto the Secure Boot. Press Enter and a prompt will show up for you to confirm.

Reset To Setup Mode

Clear the database from the NVRAM, including all the keys and signatures installed in the Key Management menu. Press Enter and a prompt will show up for you to confirm.

Key Management

Enables expert users to modify Secure Boot Policy variables without full authentication.

► Boot

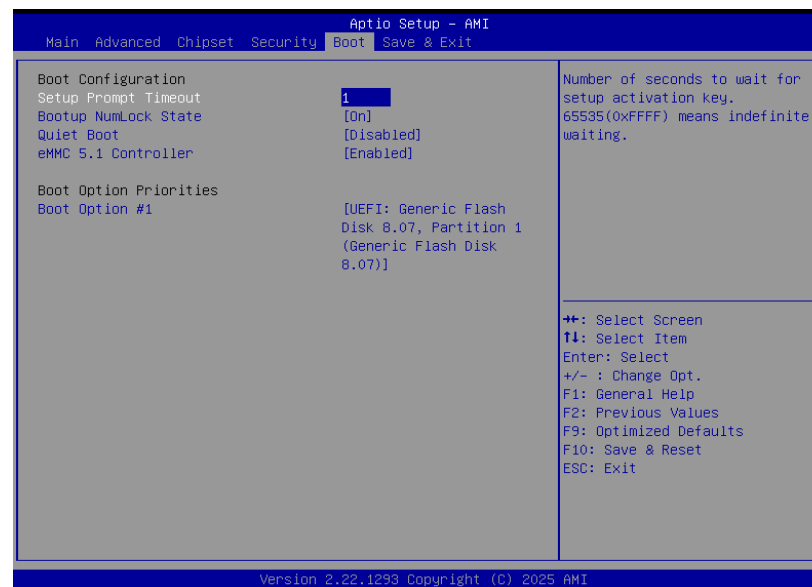

Setup Prompt Timeout

Set the number of seconds to wait for the setup activation key. 65535 (0xFFFF) denotes indefinite waiting.

Bootup NumLock State

Select the keyboard NumLock state: On or Off.

Quiet Boot

This section is used to enable or disable quiet boot option.

Boot Option Priorities

Rearrange the system boot order of available boot devices.



Note:

If “Quiet Boot” is enabled, “BGRT Logo” will show up for configuration.

► Save & Exit

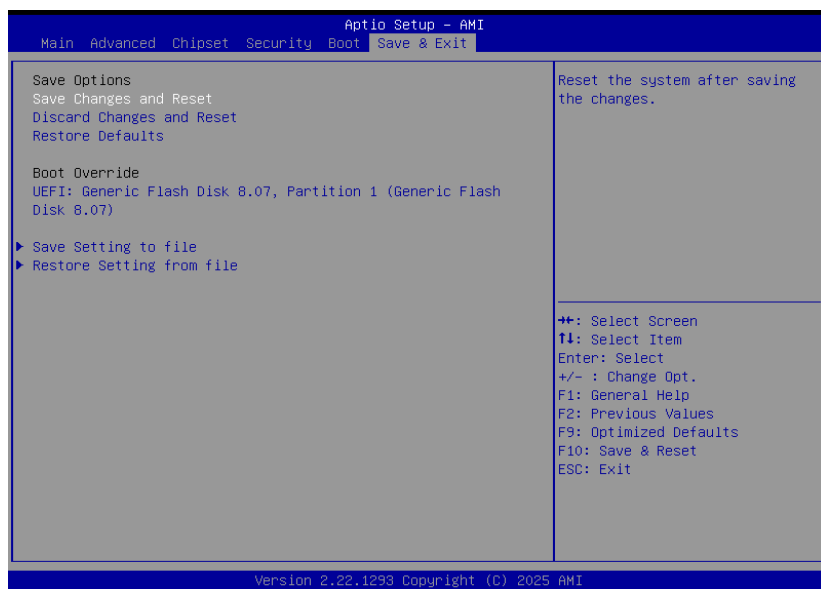
**Save Changes and Reset**

To save the changes, select this field and then press <Enter>. A dialog box will appear. Select Yes to reset the system after saving all changes made.

Discard Changes and Reset

To discard the changes, select this field and then press <Enter>. A dialog box will appear. Select Yes to reset the system setup without saving any changes.

Restore Defaults

To restore and load the optimized default values, select this field and then press <Enter>. A dialog box will appear. Select Yes to restore the default values of all the setup options.

Boot Override

Move the cursor to an available boot device and press Enter, and then the system will immediately boot from the selected boot device. The Boot Override function will only be effective for the current boot. The "Boot Option Priorities" configured in the Boot menu will not be changed.

- **Save Setting to file** Select this option to save BIOS configuration settings to a USB flash device.
- **Restore Setting from file** This field will appear only when a USB flash device is detected. Select this field to restore setting from the USB flash device.

► Updating the BIOS

To update the BIOS, you will need the new BIOS file and a flash utility. Please contact technical support or your sales representative for the files and specific instructions about how to update BIOS with the flash utility.

► Notice: BIOS SPI ROM

1. The Intel® Management Engine has already been integrated into this system board. Due to the safety concerns, the BIOS (SPI ROM) chip cannot be removed from this system board and used on another system board of the same model.
2. The BIOS (SPI ROM) on this system board must be the original equipment from the factory and cannot be used to replace one which has been utilized on other system boards.
3. If you do not follow the methods above, the Intel® Management Engine will not be updated and will cease to be effective.

**Note:**

- a. You can take advantage of flash tools to update the default configuration of the BIOS (SPI ROM) to the latest version anytime.
- b. When the BIOS IC needs to be replaced, you have to populate it properly onto the system board after the EEPROM programmer has been burned and follow the technical person's instructions to confirm that the MAC address should be burned or not.

Chapter 4 - Out Of Band Setup (* Option by project support)

▶ What's OOB (Out-Of-Band) Management

As Industrial IoT demands rise in recent decades, the number of connected IoT devices drastically grow. However, the personnel responsible for equipment maintenance cannot meet the growing numbers of IoT devices; additionally, unexpected factors occur, e.g. the global pandemic. It seems like it is harder to maintain and repair the equipment in a timely manner.

Remote management without running OS. Out-of-band (OOB) technology can timely predict equipment status before the shutdown and efficiently activate OS auto-backup and recovery despite host crashes. Furthermore, the data of device health status are collected automatically to the cloud, and users can easily monitor all connected devices through a customizable UX dashboard.

▶ Key Features

- ▶ Open SSH login
- ▶ Remote power on/off & reset control
- ▶ Remote hardware monitor log
- ▶ Recovery (Factory Mode)
- ▶ Remote BIOS setup & uefi shell (serial over lan)
- ▶ Remote BIOS update SPI-NAND
- ▶ Remote BIOS update SOL & DFI USB-Storage
- ▶ Change OOB IP address

► ADN253 cBMC

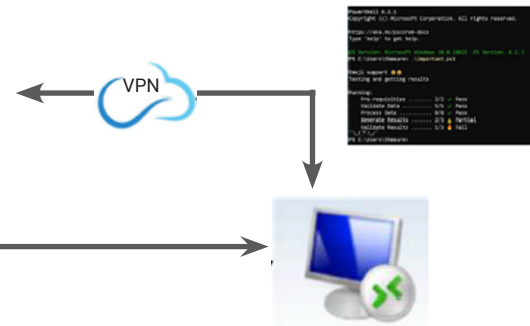
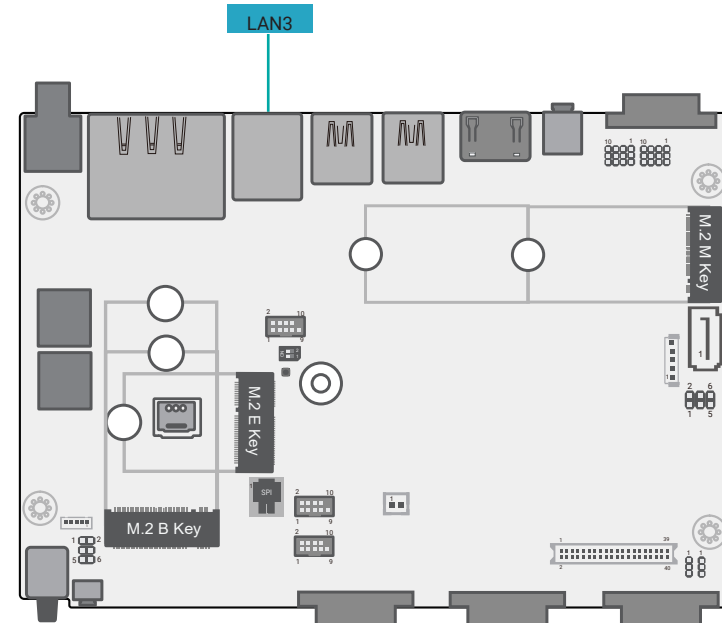
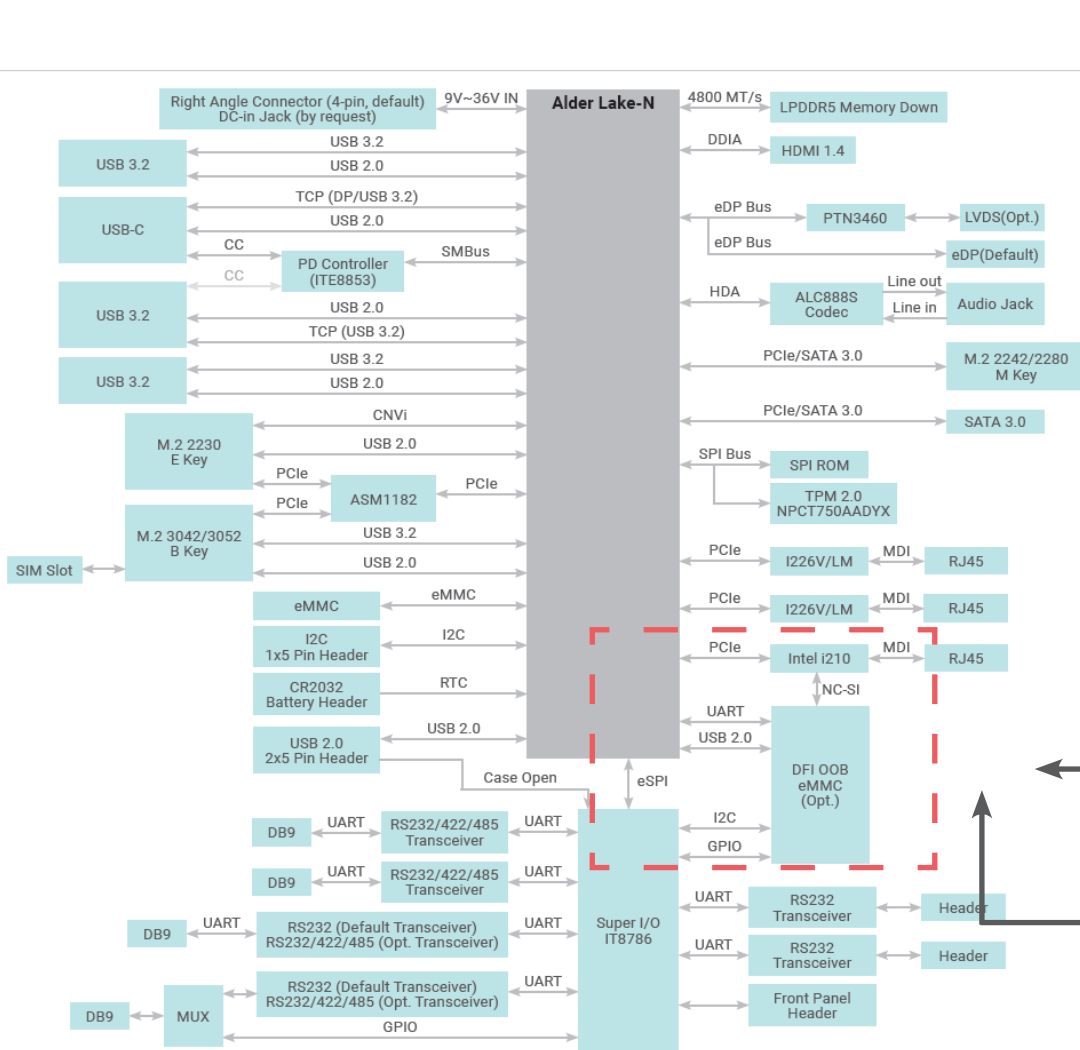

► Default Password Setting

Step 1:

The default password can be obtained through the "ping" and "arp -a" commands.

```

C:\Users\test>ping 192.168.10.100

Pinging 192.168.10.100 with 32 bytes of data:
Reply from 192.168.10.100: bytes=32 time<1ms TTL=64
Reply from 192.168.10.100: bytes=32 time<1ms TTL=64
Reply from 192.168.10.100: bytes=32 time<1ms TTL=64
Reply from 192.168.10.100: bytes=32 time<1ms TTL=64

Ping statistics for 192.168.10.100:
    Packets: Sent = 4, Received = 4, Lost = 0 (0% loss),
    Approximate round trip times in milli-seconds:
        Minimum = 0ms, Maximum = 0ms, Average = 0ms

C:\Users\test>arp -a

Interface: 192.168.10.101 --- 0x5
Internet address      Physical Address      Type
192.168.10.100        00-01-29-00-00-01     dynamic
192.168.10.255        ff-ff-ff-ff-ff-ff     static
224.0.0.22            01-00-5e-00-00-16     static
224.0.0.251           01-00-5e-00-00-fb     static
224.0.0.252           01-00-5e-00-00-fc     static

C:\Users\test>
    
```

After entering ping OOB IP address and execute "arp -a" commands, the screen will show OOB MAC address.

The default password is OOB MAC address -1. If there are letters from A to F, make sure they are all uppercase letters.

For example 1: 000129000001-1 --> 000129000000

For example 2: 000129110000-1 --> 00012910FFFF

Step 2:

Use a LAN cable to connect a LAN port on PC and a LAN port (i210) on the board.

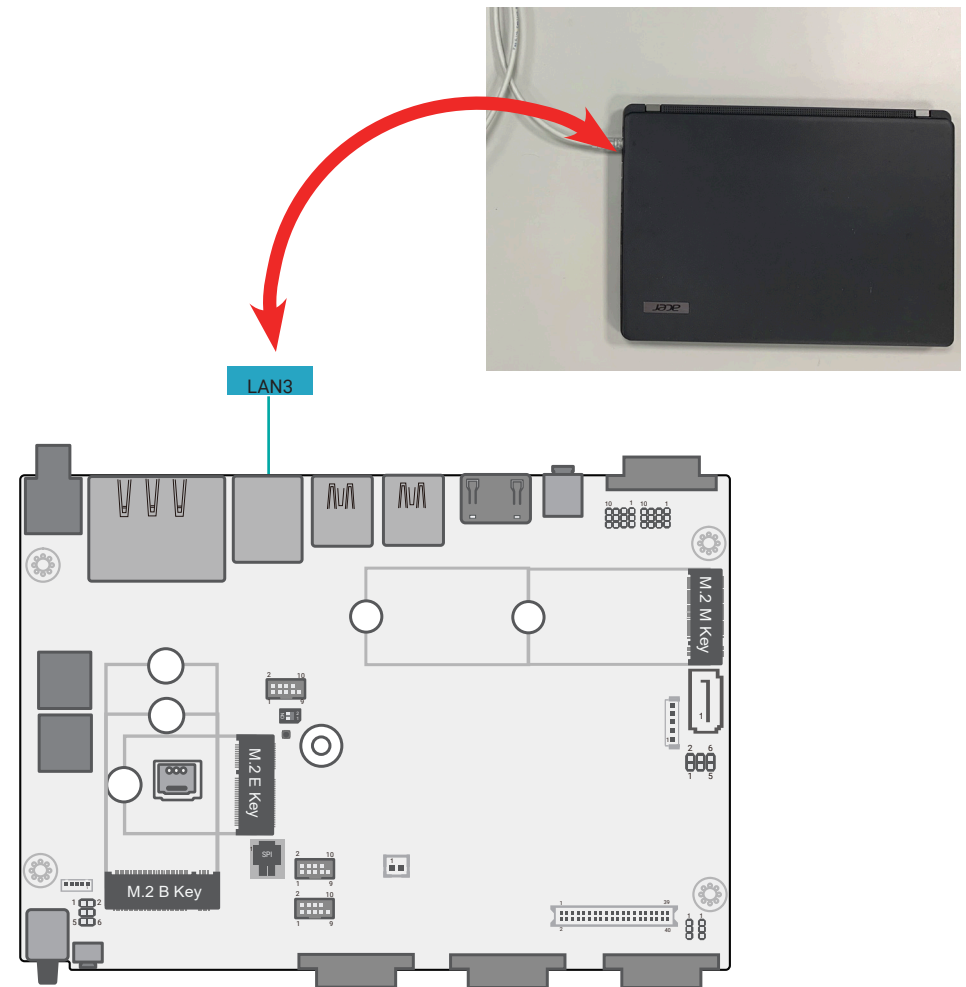

Step 3: (Please note that this setup is only required for the first time use.)

Setup Lan IP Address - Open **Network Status** go to **Advanced network settings** and click **Change adapter options**, double click **Ethernet**.

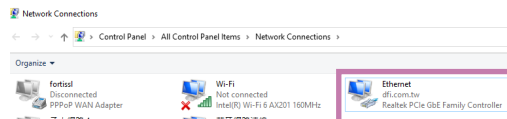
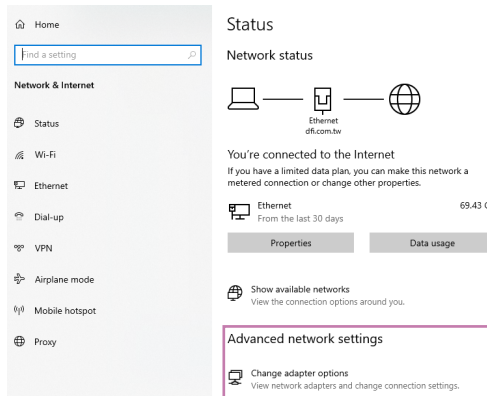

Click **Priorities** - Select **Internet Protocol Version 4 (TCP/IPv4)** and click **Priorities**.
Type in the following information, then press **OK**.

IP address: 192.168.10.99
Subnet mask: 255.255.255.0

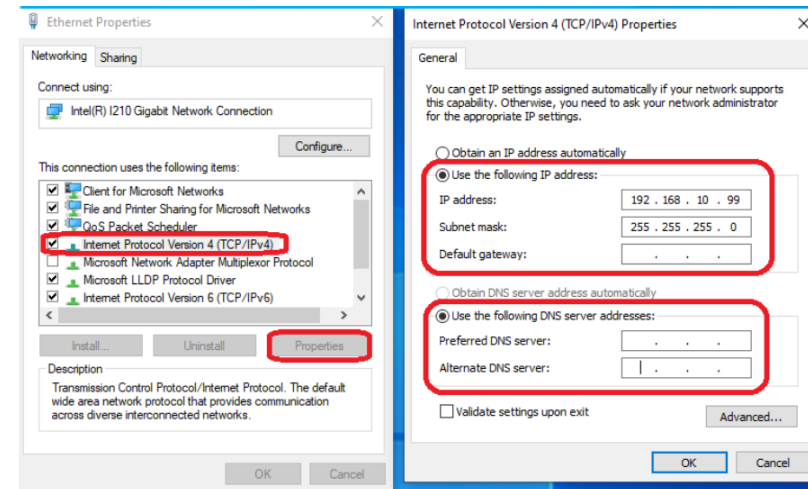

Note:

Remote PC and DFI system shall be in the same network domain.

Step 4:

Execute windows Command Prompt.

To run the command prompt:

- Pressing Windows key + R key to open "Run" box. Type "cmd" and then click "OK".
- Or
- Using the search bar in the Windows 10, type "cmd" into the search bar and press enter.

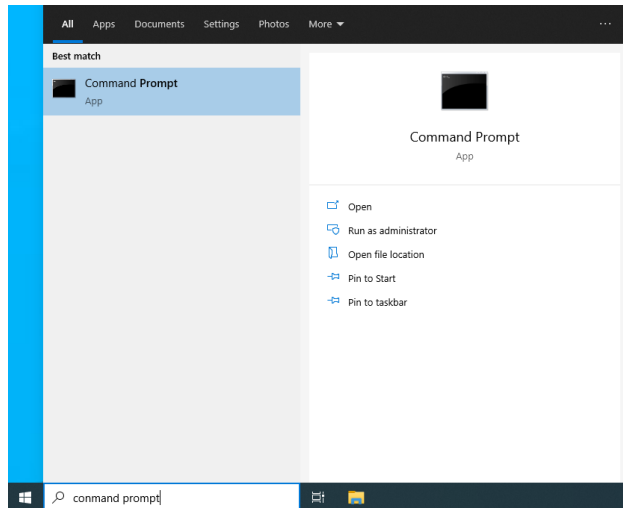

Open SSH login

Please obtain a default password before logging in, and type in the information as follows:

C:\users\user name> . ssh root@192.168.10.100

**Are you sure you want to continue connecting : yes
(This question only appears for the first time login.)**

Please go to the next page for how to use SSH key pair to log in without entering a password.



Note:

For creating a default password, please refer to [Default Password Setting - Step 1](#).

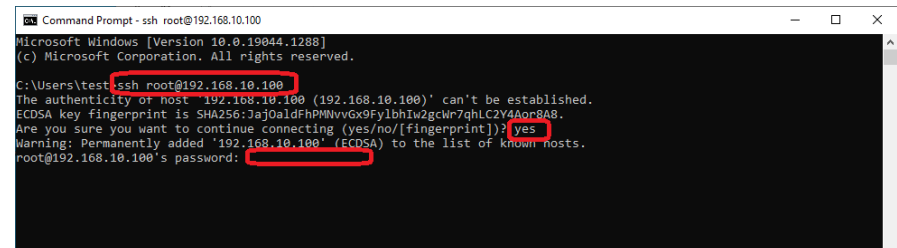

Note:

When you enter a default password in Command Prompt, it doesn't appear or show up on the screen.

After entering the password, you will see **~#**

Then type in **cd DFI**.

When it displays **/DFI #**, you may now start typing in commands for each function.

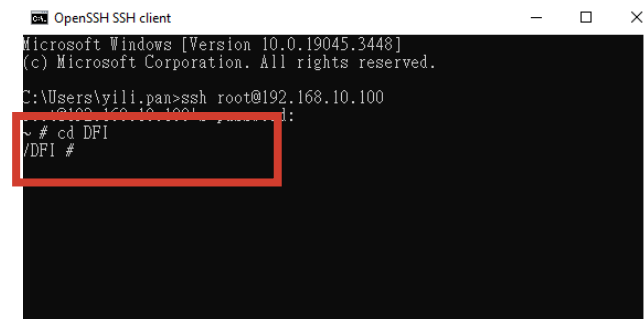

Use SSH key Pair Login

Step 1:

Execute windows Command Prompt.

To run the command prompt:

- Pressing Windows key + R key to open "Run" box. Type "cmd" and then click "OK".
- Or
- Using the search bar in the Windows 10, type "cmd" into the search bar and press enter.

Please enter the command as follows: **C:\users\user name> : ssh-keygen**

The file will be saved in **C:\users\user name\.ssh** folder.

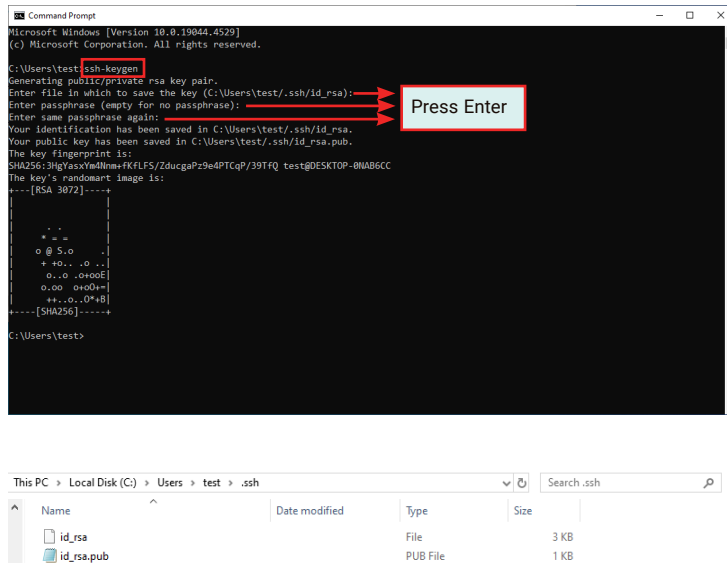

Step 2:

Please obtain a default password before logging in, and type in the information as follows:

C:\users\user name> : ssh root@192.168.10.100 "mkdir -p ~/.ssh && chmod 700 ~/.ssh"

Are you sure you want to continue connecting : yes
(This question only appears for the first time log in)



Note:

- For creating a default password, please refer to [Default Password Setting - Step 1](#).
- When you enter a default password in Command Prompt, it doesn't appear or show up on the screen.

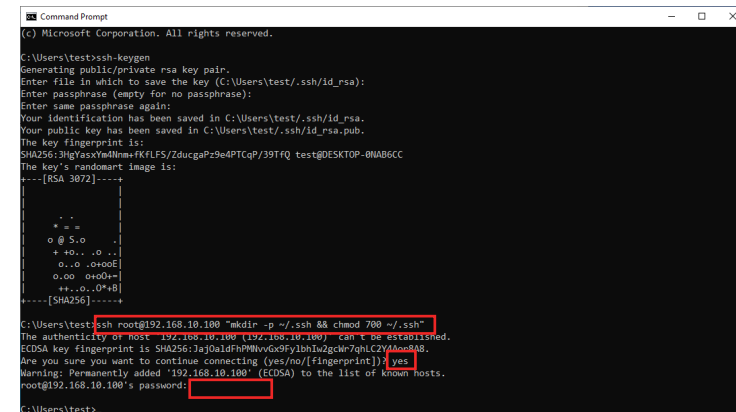

Step 3:

Please enter the command as follows:

scp C:\Users\test\.ssh\id_rsa.pub root@192.168.10.100:~/.ssh/authorized_keys

And then enter the password.



Note:

- For creating a default password, please refer to [Default Password Setting - Step 1](#).
- When you enter a default password in Command Prompt, it doesn't appear or show up on the screen.

```

Command Prompt
Enter file in which to save the key (C:\Users\test\.ssh\id_rsa):
Enter passphrase (empty for no passphrase):
Enter same passphrase again:
Your identification has been saved in C:\Users\test\.ssh\id_rsa.
Your public key has been saved in C:\Users\test\.ssh\id_rsa.pub.
The key fingerprint is:
SHA256:3HgYassYndNm+FKFLFS/ZducgaPz9e4PTcQp/39TFQ test@DESKTOP-0NAB6CC
The key's randomart image is:
+-----[RSA 3072]-----+
|
| o @ S.o .
| + + + . . .
| o..o .o+oE
| o..o o+o+o+
| ++..o..O*B
|-----[SHA256]-----+

C:\Users\test>ssh root@192.168.10.100 "mkdir -p ~/.ssh && chmod 700 ~/.ssh"
The authenticity of host '192.168.10.100 (192.168.10.100)' can't be established.
ECDSA key fingerprint is SHA256:JaJ0aldFhPMvVg9Fy1bh1w2gcw7qHLc2Y4Aor8A8.
Are you sure you want to continue connecting (yes/no/[fingerprint])? yes
Warning: Permanently added '192.168.10.100' (ECDSA) to the list of known hosts.
root@192.168.10.100's password:
C:\Users\test>scp C:\Users\test\.ssh\id_rsa.pub root@192.168.10.100:~/.ssh/authorized_keys
root@192.168.10.100's password:
id_rsa.pub 100% 575 0.6KB/s 00:00
C:\Users\test>
    
```

- Use SSH key Pair Login - Change A Path and Create A Filename

You can also type in a path location where you want to save the file and create a file name.

For example :

Please enter the command as follows: **ssh-keygen -f C:\Users\test\.ssh\4-1c-b4-0a-b0-6a**

The file will be located in **C:\users\test** folder.

The file name is **a4-1c-b4-0a-b0-6a**.

```

Microsoft Windows [Version 10.0.19044.4529]
(c) Microsoft Corporation. All rights reserved.

C:\Users\test>ssh-keygen -f C:\Users\test\.ssh\4-1c-b4-0a-b0-6a
Generating public/private rsa key pair:
Enter passphrase (empty for no passphrase):
Enter same passphrase again:
Your identification has been saved in C:\Users\test\.ssh\4-1c-b4-0a-b0-6a.pub.
The key fingerprint is:
SHA256:IVBSU7X2omKYT92j127gbBdkydsDdn4BAf1ZVxK2zk test@DESKTOP-0NAB6CC
The key's randomart image is:
+-----[RSA 3072]-----+
|
| o.o.o+..
| o+..+..
| .oo.oE+
| o.+..+
| S 0000
| o .o.o..
| o + 0000 ..
| + . . . +
| + . . . +
|-----[SHA256]-----+

C:\Users\test>
    
```

Step 4:

Please enter the command as follows: **ssh root@192.168.10.100**

It will log in automatically, no need to enter any password.

And then you will see **~#**

```

OpenSSH SSH client
Enter passphrase (empty for no passphrase):
Enter same passphrase again:
Your identification has been saved in C:\Users\test\.ssh\id_rsa.
Your public key has been saved in C:\Users\test\.ssh\id_rsa.pub.
The key fingerprint is:
SHA256:3HgYassYndNm+FKFLFS/ZducgaPz9e4PTcQp/39TFQ test@DESKTOP-0NAB6CC
The key's randomart image is:
+-----[RSA 3072]-----+
|
| o @ S.o .
| + + + . . .
| o..o .o+oE
| o..o o+o+o+
| ++..o..O*B
|-----[SHA256]-----+

C:\Users\test>ssh root@192.168.10.100 "mkdir -p ~/.ssh && chmod 700 ~/.ssh"
The authenticity of host '192.168.10.100 (192.168.10.100)' can't be established.
ECDSA key fingerprint is SHA256:JaJ0aldFhPMvVg9Fy1bh1w2gcw7qHLc2Y4Aor8A8.
Are you sure you want to continue connecting (yes/no/[fingerprint])? yes
Warning: Permanently added '192.168.10.100' (ECDSA) to the list of known hosts.
root@192.168.10.100's password:
C:\Users\test>scp C:\Users\test\.ssh\id_rsa.pub root@192.168.10.100:~/.ssh/authorized_keys
root@192.168.10.100's password:
id_rsa.pub 100% 575 0.6KB/s 00:00
C:\Users\test>ssh root@192.168.10.100
#
    
```

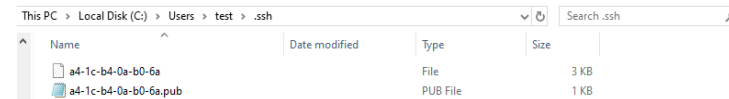

Step 1:

Please obtain a default password before logging in, and type in the information as follows:

```
C:\users\user_name> : ssh root@192.168.10.100 "mkdir -p ~/.ssh && chmod 700 ~/.ssh"
```

Are you sure you want to continue connecting : yes
(This question only appears for the first time log in)



Note:

- For creating a default password, please refer to [Default Password Setting - Step 1](#).
- When you enter a default password in Command Prompt, it doesn't appear or show up on the screen.

Step 2:

Please enter the command as follows:

```
scp C:\Users\test\ssh\4-1c-b4-0a-b0-6a.pub root@192.168.10.100:~/.ssh/authorized_keys
```

And then enter the password.



Note:

- For creating a default password, please refer to [Default Password Setting - Step 1](#).
- When you enter a default password in Command Prompt, it doesn't appear or show up on the screen.

```
Microsoft Windows [Version 10.0.19044.4529]
(c) Microsoft Corporation. All rights reserved.

C:\Users\test>ssh-keygen -f C:\Users\test\ssh\4-1c-b4-0a-b0-6a
Generating public/private rsa key pair.
Enter passphrase (empty for no passphrase):
Enter same passphrase again:
Your identification has been saved in C:\Users\test\ssh\4-1c-b4-0a-b0-6a.
Your public key has been saved in C:\Users\test\ssh\4-1c-b4-0a-b0-6a.pub.
The key fingerprint is:
SHA256:1V8S07X2omKYT92j127gbDkydsDdn4Baf1ZVxK2zk test@DESKTOP-0NAB6CC
The key's randomart image is:
----[RSA 3072]-----
  o.o+o+..
  o+==..
  o 80.+8E+
  o.o+..+*
  S  ooo
  o . o.o..
  o + oooo ..
  + . +.+ |
  .o+
  ----[SHA256]-----

C:\Users\test>ssh root@192.168.10.100 "mkdir -p ~/.ssh && chmod 700 ~/.ssh"
The authenticity of host '192.168.10.100 (192.168.10.100)' can't be established.
ECDSA key fingerprint is SHA256:Jaj0aldFhPwVvx9fy1bhIw2gchw7qhlC2YAor8A8.
Are you sure you want to continue connecting (yes/no/[fingerprint])? yes
Warning: Permanently added '192.168.10.100' (ECDSA) to the list of known hosts.
root@192.168.10.100's password:
C:\Users\test>
```

```
Microsoft Windows [Version 10.0.19044.4529]
(c) Microsoft Corporation. All rights reserved.

C:\Users\test>ssh-keygen -f C:\Users\test\ssh\4-1c-b4-0a-b0-6a
Generating public/private rsa key pair.
Enter passphrase (empty for no passphrase):
Enter same passphrase again:
Your identification has been saved in C:\Users\test\ssh\4-1c-b4-0a-b0-6a.
Your public key has been saved in C:\Users\test\ssh\4-1c-b4-0a-b0-6a.pub.
The key fingerprint is:
SHA256:1V8S07X2omKYT92j127gbDkydsDdn4Baf1ZVxK2zk test@DESKTOP-0NAB6CC
The key's randomart image is:
----[RSA 3072]-----
  o.o+o+..
  o+==..
  o 80.+8E+
  o.o+..+*
  S  ooo
  o . o.o..
  o + oooo ..
  + . +.+ |
  .o+
  ----[SHA256]-----

C:\Users\test>scp C:\Users\test\ssh\4-1c-b4-0a-b0-6a.pub root@192.168.10.100:~/.ssh/authorized_keys
root@192.168.10.100's password:
100% 575 0.6KB/s 00:00
C:\Users\test>
```

Step 3:

Please enter the command as follows:

```
ssh -i C:\Users\test\ssh\4-1c-b4-0a-b0-6a root@192.168.10.100
```

It will log in automatically, no need to enter any password.

And then you will see ~#

```
OpenSSH SSH client
Enter passphrase (empty for no passphrase):
Enter same passphrase again:
Your identification has been saved in C:\Users\test\ssh\4-1c-b4-0a-b0-6a.
Your public key has been saved in C:\Users\test\ssh\4-1c-b4-0a-b0-6a.pub.
The key fingerprint is:
SHA256:1V8S07X2omKYT92j127gbDkydsDdn4Baf1ZVxK2zk test@DESKTOP-0NAB6CC
The key's randomart image is:
----[RSA 3072]-----
  . . . o
  + + o +
  % + +
  ++ E o S o
  |o.o+..+o
  |..+..+..+
  |oo 4oo.o
  |
  |----[SHA256]-----

C:\Users\test>ssh root@192.168.10.100 "mkdir -p ~/.ssh && chmod 700 ~/.ssh"
The authenticity of host '192.168.10.100 (192.168.10.100)' can't be established.
ECDSA key fingerprint is SHA256:Jaj0aldFhPwVvx9fy1bhIw2gchw7qhlC2YAor8A8.
Are you sure you want to continue connecting (yes/no/[fingerprint])? yes
Warning: Permanently added '192.168.10.100' (ECDSA) to the list of known hosts.
root@192.168.10.100's password:

C:\Users\test>scp C:\Users\test\ssh\4-1c-b4-0a-b0-6a.pub root@192.168.10.100:~/.ssh/authorized_keys
root@192.168.10.100's password:
100% 575 0.6KB/s 00:00
a4-1c-b4-0a-b0-6a.pub
C:\Users\test>ssh -i C:\Users\test\ssh\4-1c-b4-0a-b0-6a root@192.168.10.100
```

► Remote Control PC Power On/Off

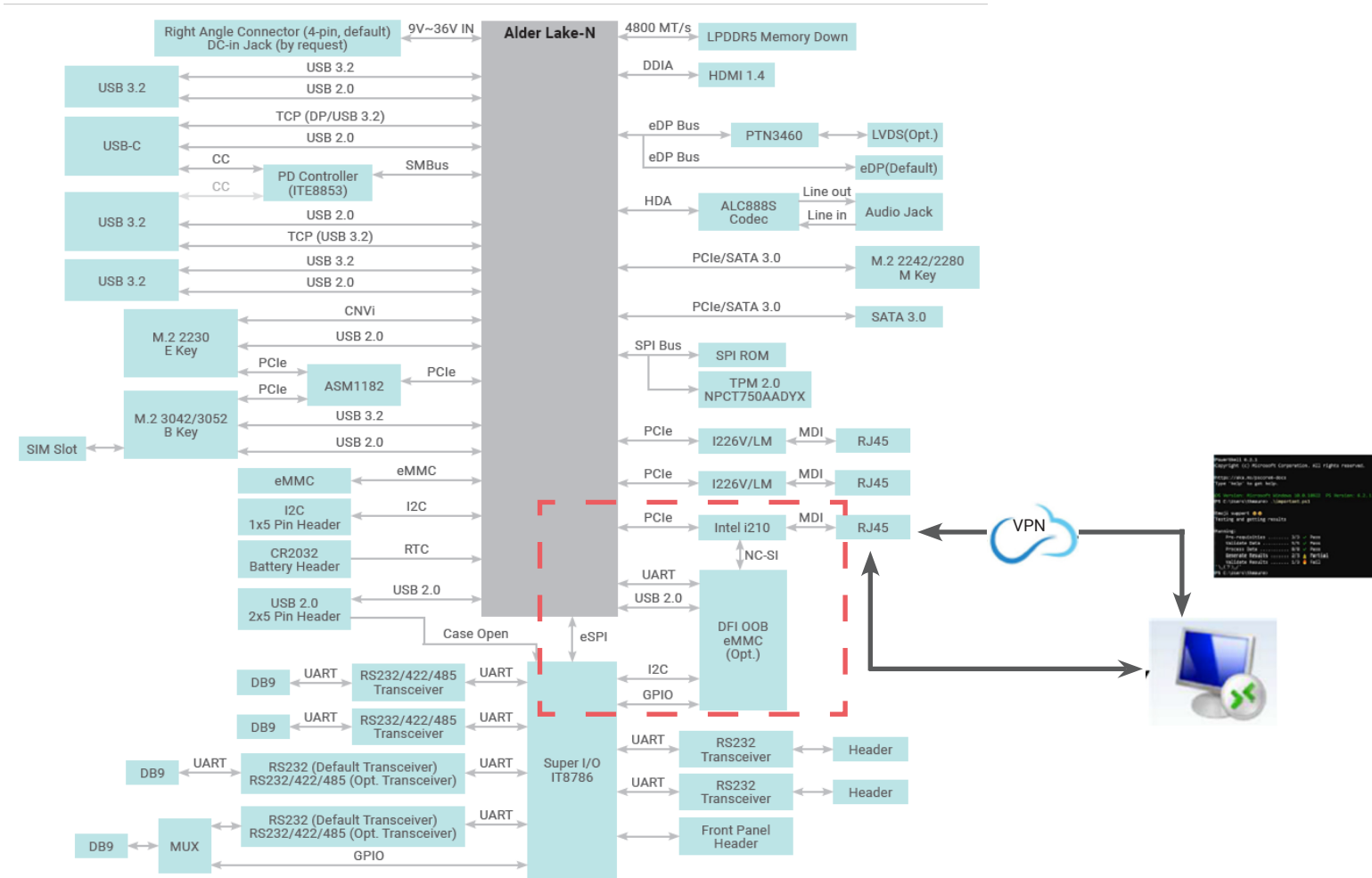

PC Power On/Off Status Check

Please complete [Default Password Setting - Step 4](#) before entering the following command.
Check the current power On/Off status remotely by typing in following command.

Shell Script : `./pc_status.sh`

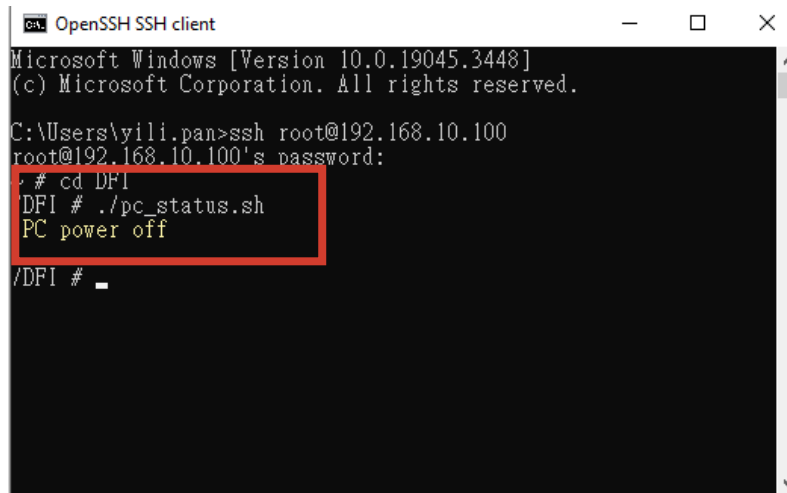

```
ca. OpenSSH SSH client
Microsoft Windows [Version 10.0.19045.3448]
(c) Microsoft Corporation. All rights reserved.

C:\Users\yili.pan>ssh root@192.168.10.100
root@192.168.10.100's password:
# cd DFI
DFI # ./pc_status.sh
PC power off
/DFI # _
```

Turn On/Off PC Remotely

After the status check, you can control PC power on/off remotely.
Please complete [Default Password Setting - Step 4](#) before entering the following command.
To toggle power on or power off, just type in the same command again.

Shell Script : `./power_button.sh`



```
ca. OpenSSH SSH client
Microsoft Windows [Version 10.0.19045.3448]
(c) Microsoft Corporation. All rights reserved.

C:\Users\yili.pan>ssh root@192.168.10.100
root@192.168.10.100's password:
# cd DFI
DFI # ./pc_status.sh
PC power off

DFI # ./power_button.sh
DFI # ./pc_status.sh
PC power on

DFI # ./power_button.sh
DFI # ./pc_status.sh
PC power off

/DFI #
```



1. Check the PC power on/off status to make sure the current power status.
2. Type in shell script: `./power_button.sh` to power on or power off the PC.
3. Then check the status again.

Perform a Timed Force Shutdown

To forcibly shut down the PC, please type in the following command.
Please complete Default Password Setting - Step 4 before entering the following command.
Numbers means this will force shutdown your PC in xx seconds (waiting time).
Setting it to 5 will shutdown your PC after 5 seconds.

Shell Script : **./power_button.sh 5**

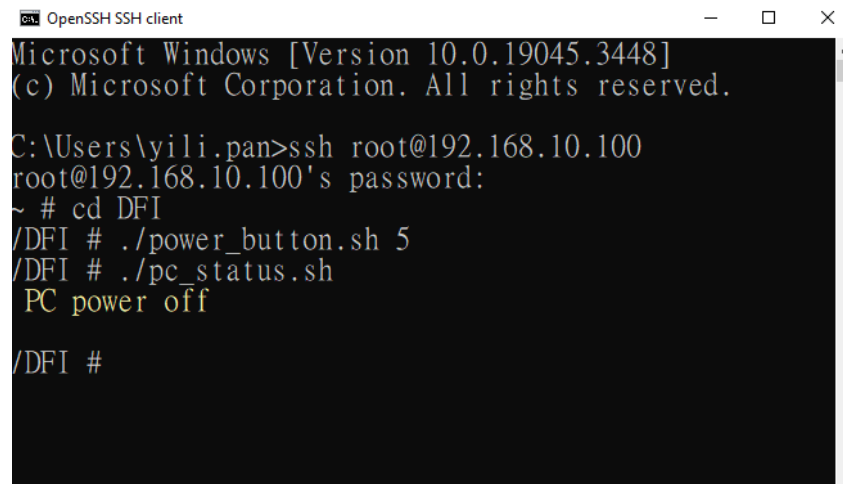

```
OpenSSH SSH client
Microsoft Windows [Version 10.0.19045.3448]
(c) Microsoft Corporation. All rights reserved.

C:\Users\yili.pan>ssh root@192.168.10.100
root@192.168.10.100's password:
~ # cd DFI
/DFI # ./power_button.sh 5
/DFI # ./pc_status.sh
PC power off

/DFI #
```

PC Rebooting

To reboot the PC, please type in the following command.
You will hear a single beep, it means PC rebooted successfully.
Please complete Default Password Setting - Step 4 before entering the following command.

Shell Script : **./reset_button.sh**

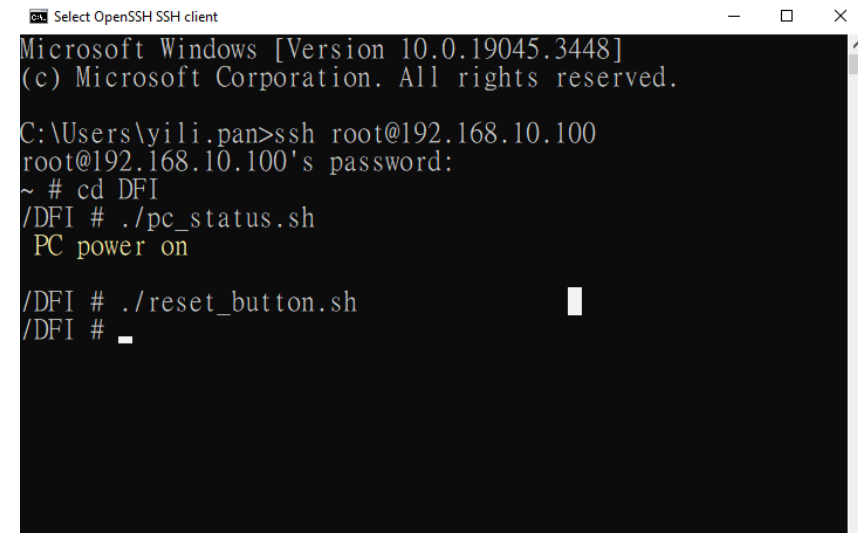

```
Select OpenSSH SSH client
Microsoft Windows [Version 10.0.19045.3448]
(c) Microsoft Corporation. All rights reserved.

C:\Users\yili.pan>ssh root@192.168.10.100
root@192.168.10.100's password:
~ # cd DFI
/DFI # ./pc_status.sh
PC power on

/DFI # ./reset_button.sh
/DFI #
```

► Remote Hardware Monitor Log (Super I/O)

I2C bus:

Super I/O: Voltage, Temperature, Fan Speed

PCH: CPU Temperature

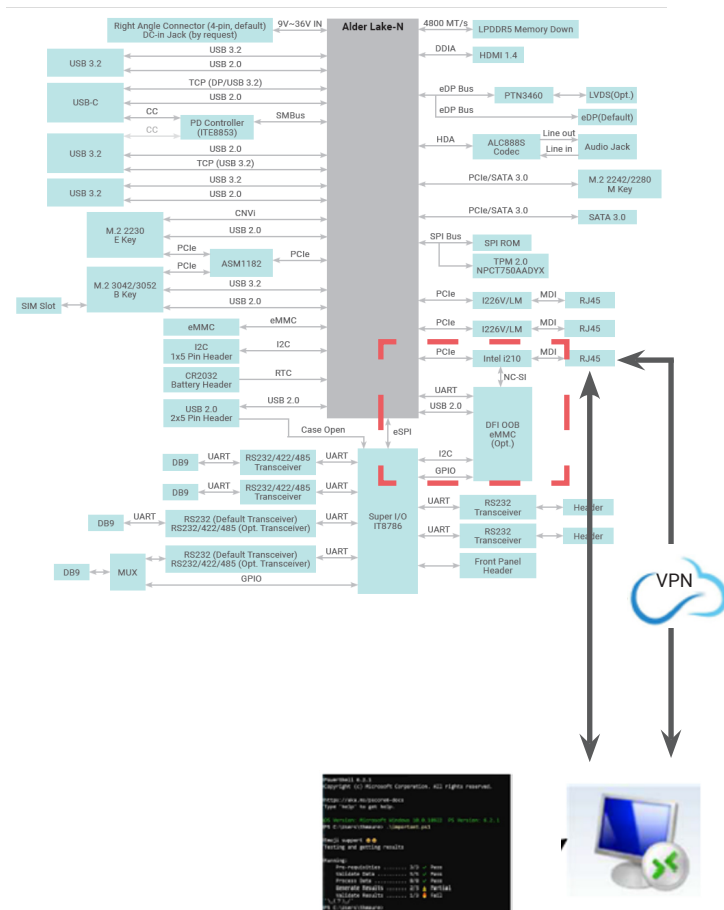

Super I/O Log

To start/stop super I/O log, please type in the following commands.

Please complete Default Password Setting - Step 4 before entering the following command.

To start super I/O log:

Shell Script : `./sio_start_log.sh YYYY-MM-DD hh:mm:ss hours /DFI/sio_log &`

For example: `./sio_start_log.sh 2024-05-24 09:00:00 24 /DFI/sio_log &`

Make sure to add the ampersand "&" at the end to run in the background.

```

/DFI # ./sio start_log.sh 2024-05-24 09:00:00 24 /DFI/sio_log &
/DFI # Fri May 24 09:00:00 UTC 2024
Save Path=/DFI/sio_log
Start log .....
/DFI #
    
```

To stop super I/O log:

Shell Script : `./sio_stop_log.sh`

```

DFI # ./sio_stop_log.sh
=== DFI COB ===
||+ Terminated
DFI # ./sio_start_log.sh 2024-05-24 09:00:00 24 /DFI/sio_log
DFI #
    
```

How to Export Super I/O Logs From OOB

To export super I/O log, please type in the following command.

Please complete [Default Password Setting - Step 4](#) before entering the following command.

Shell Script : **scp -r root@192.168.10.100:/DFI/sio_log C:\Users\username\.ssh**

For example: *scp -r root@192.168.10.100:/DFI/sio_log C:\Users\yili.pan\.ssh*

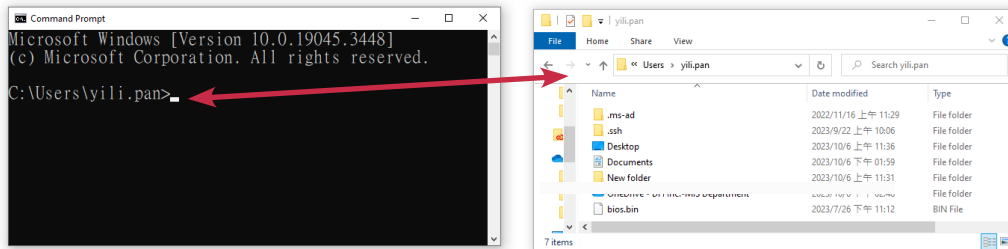

The log file is saved in C drive.

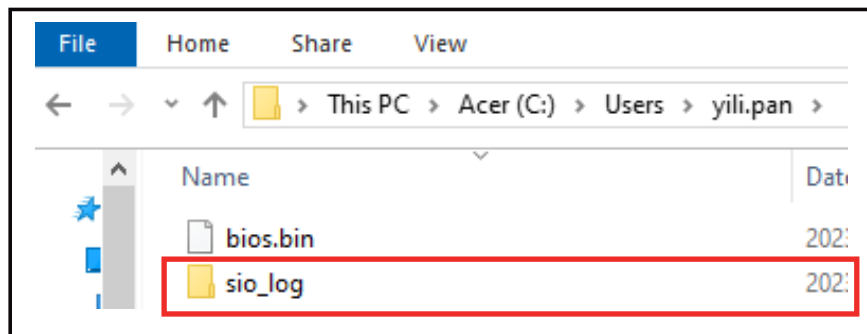

► Using USB Storage / MicroSD Card to run actions

The shell scripts for USB storage

Please execute the following commands to switch between the USB flash drive and the microSD card for the device operations.

To insert a USB flash drive, please execute a shell script as following:

Shell Script : **./insert_usb_storage.sh**

To remove a USB flash drive, please execute a shell script as following:

Shell Script : **./eject_usb_storage.sh**

To format a USB flash drive to factory settings, please execute a shell script as following:

Shell Script : **./format_usb_storage.sh**

If file operations are performed via a USB flash drive under OOB, need to refresh windows to update. To update a USB flash drive, please execute a shell script as following:

Shell Script : **./refresh_usb_storage.sh**

The shell scripts for MicroSD card

Please format your MicroSD card to FAT32 before executing any commands, and then insert it into the OOB MicroSD card slot.

There are two ways to format a MicroSD card :

1. You can format a microSD card using your Windows computer. Make sure that once you have formatted, your card will be formatted to FAT32 filesystem type.
2. You can format a micro SD card using commands.

Formatting a microSD Card under OOB

Please format a MicroSD card before using it to log in OOB.

What are the situations do you need to format a MicroSD card :

- A brand new MicroSD card.
- Your MicorSD card is not formatted as FAT32.

The instructions are as follows :

```

~ # fdisk /dev/mmcb1k0
The number of cylinders for this disk is set to 480896.
There is nothing wrong with that, but this is larger than 1024,
and could in certain setups cause problems with:
 1) software that runs at boot time (e.g., old versions of LILO)
 2) booting and partitioning software from other OS
   (e.g., DOS fdisk, 2/2 fdisk)

Command (m for help) n
Partition type
  p primary partition (1-4)
  e extended

3 p
Partition number (1-4): 1
First sector (16-30777343, default 16): Press Enter
Using default value 16
Last sector or +size{K,M,G,T} (16-30777343, default 30777343): Press Enter
Using default value 30777343
Command (m for help): w
8 partition table has been altered.
Calling ioctl() to re-read partition table
~ # mkdosfs /dev/mmcb1k0p1
~ # reboot
9
  
```

- | | | | |
|---|--|---|--|
| 1 | Type in fdisk /dev/mmcb1k0 | 6 | Press enter |
| 2 | Choose : n (a lowercase letter) | 7 | Choose : w (a lowercase letter) |
| 3 | Choose : p (a lowercase letter) | 8 | Type in mkdosfs /dev/mmcb1k0p1 |
| 4 | Choose : 1 | 9 | Type in reboot |
| 5 | Press enter | | |

To insert a MicroSD card, please execute a shell script as following:

Shell Script : **./insert_uSD.sh /dev/mmcb1k0p1**

To remove a MicroSD card, please execute a shell script as following:

Shell Script : **./eject_uSD.sh**

If file operations are performed via a MicroSD card under OOB, need to refresh windows to update. To update a USB flash drive, please execute a shell script as following:

Shell Script : **./refresh_uSD.sh /dev/mmcb1k0p1**

► BIOS

Remote BIOS Update

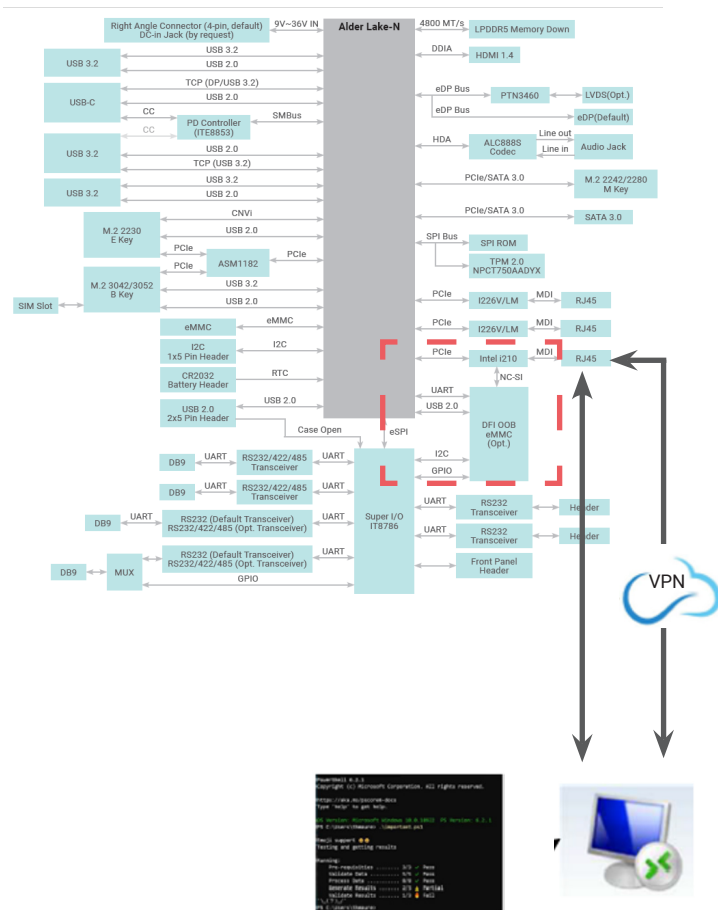

Step 1:

Before starting the update, you will have to prepare **BIOS bin file**.

BIOS bin file (Every BIOS file has a different file name to be used as a command, please enter the file name accordingly.)

How to request to obtain the files and update BIOS, please watch the video below for more information:

<https://www.dfi.com/tw/knowledge/video/5>

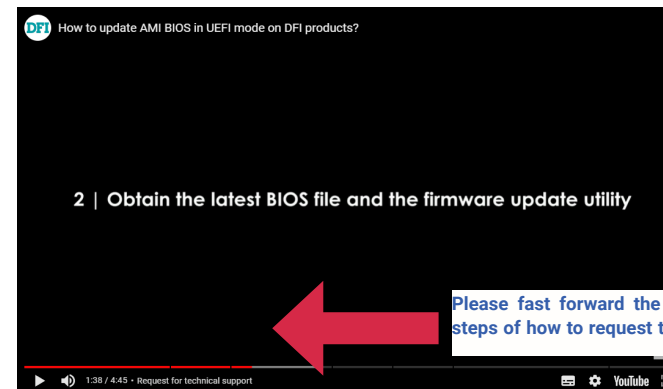

Please fast forward the video to 1:31 and follow the steps of how to request the BIOS files from DFI.

Step 2:

Copy BIOS bin file to its corresponding users folder in C drive.

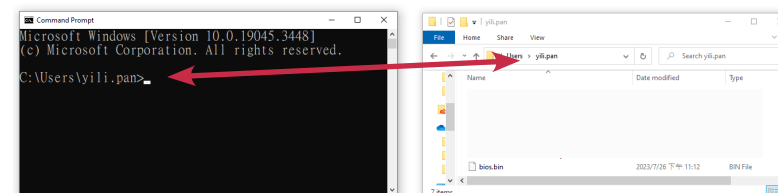

Step 3:

Open command prompt and type in the command below.
Every BIOS file has a different file name used as a command, please enter the file name accordingly.

Shell Script : **scp bios.bin file name root@192.168.10.100:~/DFI/bios/**

For example:

BIOS file name : B246.18A

Shell Script : scp B246.18A root@192.168.10.100:~/DFI/bios/

```
C:\Users\test>scp B246.18A root@192.168.10.100:~/DFI/bios/
```

Please enter a default password.
root@192.168.10.100's password:



Note:

For creating a default password, please refer to [Default Password Setting - Step 1](#).

Refresh DFI USB storage to notify windows

Shell Script : **ssh root@192.168.10.100 ./DFI/refresh_usb_storage.sh**

```
C:\Users\test>ssh root@192.168.10.100 ./DFI/refresh_usb_storage.sh
root@192.168.10.100's password:

=== DFI OOB ===

C:\Users\test>
```

Step 4:

Run SSH command:
Please type in the information as follows:

C:\users\user name> : ssh root@192.168.10.100

Are you sure you want to continue connecting : yes
(This question only appears for the first time log in)

root@192.168.10.100's password:

For creating a default password, please refer to [Default Password Setting - Step 1](#).

After entering the password, you will see **~#** Then type in **cd /DFI/bios/**

Step 5:

For the next step, you will have to shut down the PC if the power is still on.

To turn off the pc, enter **cd ..** to go back one level.

Type in **./power_button.sh** to execute shutdown.

Then type in **cd bios/**

and the final step, type in **/DFI/bios #./update_bios.sh BIOS bin file name** to begin the BIOS update.

Enter the following command to start updating BIOS:

Shell Script : **./updatebios.sh bios bin file name**

For example:

BIOS file name : B246.18A

Shell Script : ./updatebios.sh B246.18A

```
OpenSSH client
Microsoft Windows [Version 10.0.19045.3448]
(c) Microsoft Corporation. All rights reserved.

C:\Users\yili.pan>ssh root@192.168.10.100
root@192.168.10.100's password:
~ # cd DFI/bios/.
/DFI/bios # ./updatebios.sh B246.18A
Please shut down the PC, and execute again

/DFI/bios # cd ..
/DFI # ./power_button.sh
/DFI # cd bios/
/DFI/bios # ./updatebios.sh B246.18A

=== DFI OOB ===
Using clock_gettime for delay loops (clk_id: 1, resolution: 1ns).
The following protocols are supported: SPI.
Probing for Winbond W25Q256JV_Q, 32768 kB; compare id: id1 0xef, id2 0x4019
Found Winbond flash chip "W25Q256JV_Q" (32768 kB, SPI) on linux_spi.
Chip status register is 0x00.

Please wait...

Reading old flash chip contents... Reading old flash chip contents... done.
Erasing and writing flash chip... ..
Verifying flash... VERIFIED.
BIOS update is finished

/DFI/bios # _
```

Check BIOS Set Up from USB Storage

Before starting BIOS update, please make sure the [BIOS set up is on USB storage](#).

To check BIOS set up, please execute a shell script as following:

Shell Script : **./insert_usb_storage.sh**

If BIOS set up is on USB storage, it shows **USB Storage is exist, Please eject it.**

```
/DFI #  
/DFI # ./insert_usb_storage.sh  
  
USB Storage is exist, Please eject it
```

If BIOS set up is on MicroSD, it shows **This is USB uSD, Please execute eject_uSD.sh.**

and execute **./eject_uSD.sh**

and then execute **./insert_usb_storage.sh**

```
/DFI # ./eject_usb_storage.sh  
  
This is USB uSD, Please exec eject_uSD.sh  
  
/DFI # ./eject_uSD.sh  
/DFI # ./insert_usb_storage.sh  
/DFI #
```

Step 1:

Before starting the update, you will have to prepare two files:

1. *AfuEfiU64.efi*
2. *BIOS bin file*

How to request to obtain the files and update BIOS, please watch the video below for more information:

<https://www.dfi.com/tw/knowledge/video/5>



Please fast forward the video to 1:31 and follow the steps of how to request the BIOS files from DFI.

Step 2:

TeraTerm is already included in the DFI system.

After successfully booting to OOB, you will see a USB flash drive in the DFI system.

Please copy the teraterm folder from the USB flash drive to the computer where you want to operate the OOB.

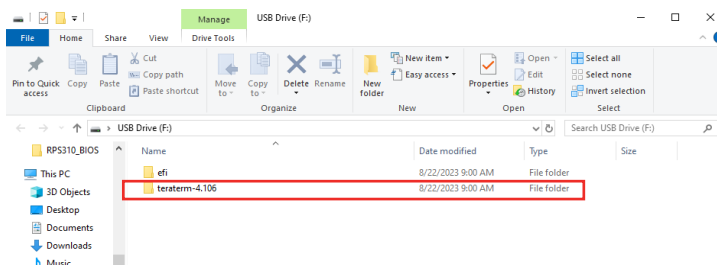

Go to Teraterm folder and open **telnet.bat**.

Press "ESC" key ,when system power on.

Run SSH command:

Please type in the information as follows:

- Copy BIOS from local PC to remote OOB module
`scp AfuEfiU64.efi root@192.168.10.100:~/DFI/USB/files`
`scp bios.bin file name root@192.168.10.100:~/DFI/USB/files`

Shell Script : `scp bios.bin file name root@192.168.10.100:~/DFI/USB/files`

For example:

BIOS file name : B246.18A

Shell Script : scp B246.18A root@192.168.10.100:~/DFI/USB/files

Shell Script : `scp AfuEfiU64.efi root@192.168.10.100:~/DFI/USB/files`

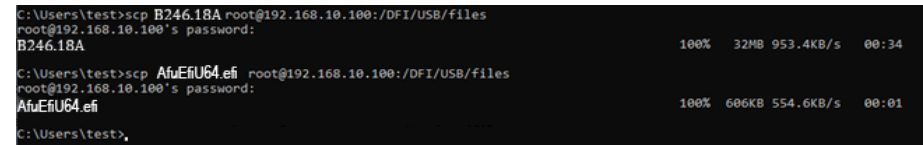

Refresh DFI USB storage to notify windows

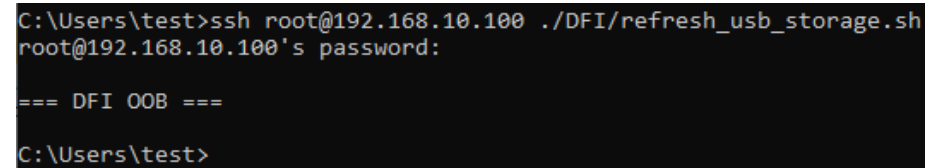

- How to Access BIOS Setup Menu When Power on

If the DFI system is power on which installed OOB, executing **power_button.sh** script to off/on the system. The script must be executed twice, first is for powering off the system, second is for powering on the system.

After the first execution, check if the system status is power off, then proceed with the second execution to be able to enter BIOS setup menu.

For the baud rate setting change, please input the shell script below to choose from 115200 or 921600. Make sure the baud rate setting from BIOS console redirection is matched.

Shell Script : `./setbaudrate.sh`

For example:

baud rate : 921600

Shell Script : ./setbaudrate.sh 921600

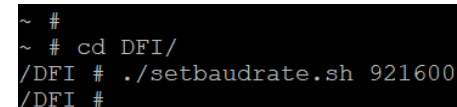

Step 3:

Access BIOS setup menu.

When system power is on, press "ESC" key in the teraterm window.

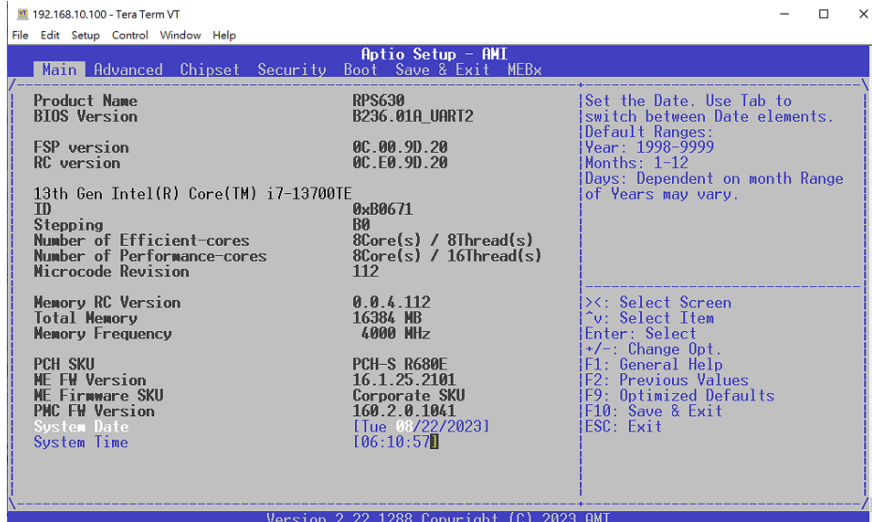

Step 4:

Please contact technical support or your sales representative for the files and specific instructions about how to update BIOS with the flash utility.

When there is no error message displayed, the BIOS update will be completed successfully.

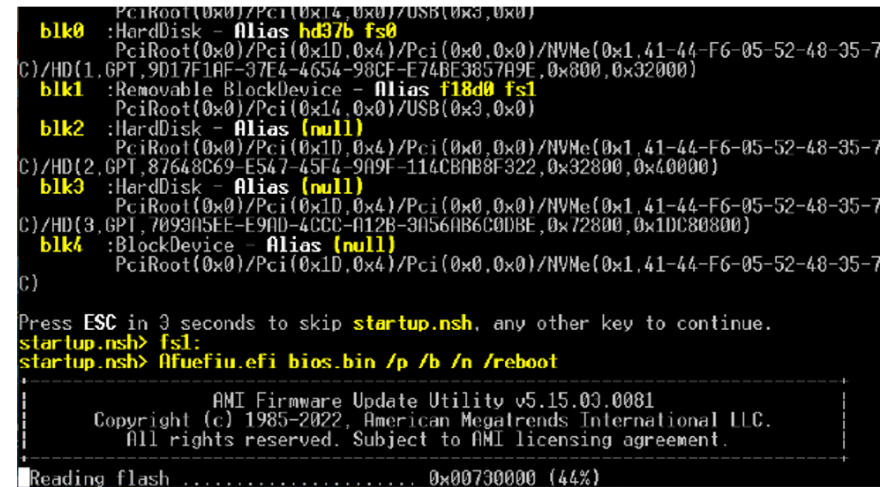

Boot from DFI USB-Storage device & update BIOS in uefi mode.

Use arrow key to select **Save & Exit** ---> **UEFI: DFI USB-Storage**

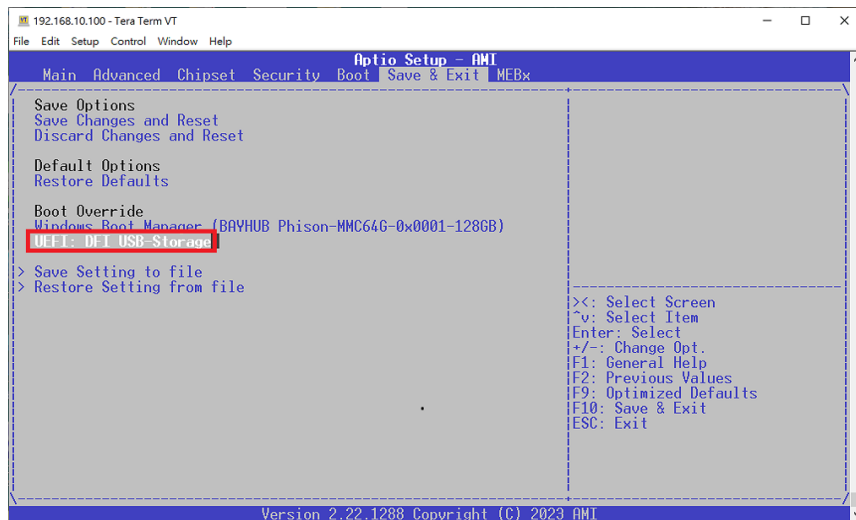

► OOB IP Address Change

SSH

Step 1:

Execute windows Command Prompt.

To run the command prompt:

- Pressing Windows key + R key to open "Run" box. Type "cmd" and then click "OK".
- Or
- Using the search bar in the Windows 10, type "cmd" into the search bar and press enter.

Typing in following command and you will see a message to ask for a new IP address.

(For example: 192.168.10.88)

Shell Script : `ssh root@192.168.10.100 ./DFI/ipconfig.sh`

```
C:\Users\test>ssh root@192.168.10.100 ./DFI/ipconfig.sh
root@192.168.10.100's password:
[1;33m Please input IP address [0m
192.168.10.88
```

Press Enter and close the current window since it is frozen and unable to operate. Please open a new window to login new IP address and run command prompts. After the network changes, make sure it should be in the same network domain as OOB.

Step 2:

In the new command prompts window, login to OOB with SSH

`ssh root@(Input new IP address)`

Shell Script : `ssh root@192.168.10.88`

```
C:\Users\test>ssh root@192.168.10.88
The authenticity of host '192.168.10.88 (192.168.10.88)' can't be established.
ECDSA key fingerprint is SHA256:JajOaldFhPMNvvGx9FylbhIw2gcWr7qhLC2Y4Aor8A8.
Are you sure you want to continue connecting (yes/no/[fingerprint])? yes
Warning: Permanently added '192.168.10.88' (ECDSA) to the list of known hosts.
root@192.168.10.88's password:
~#
```

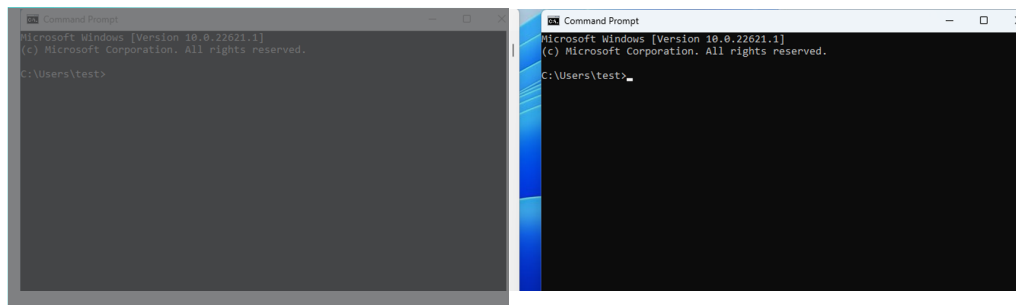

Close a frozen window → Open a new window to run command prompts with new IP address.

Console Redirection

Step 1:

After the IP address changes, Console Redirection is unable to run commands.

To fix the problem, please navigate to **C:\Program Files (x86)\teraterm**

to look for a TTL file named **'telnet.ttl'**. This file needs to be modified.

After that, Console Redirection has been updated successfully.

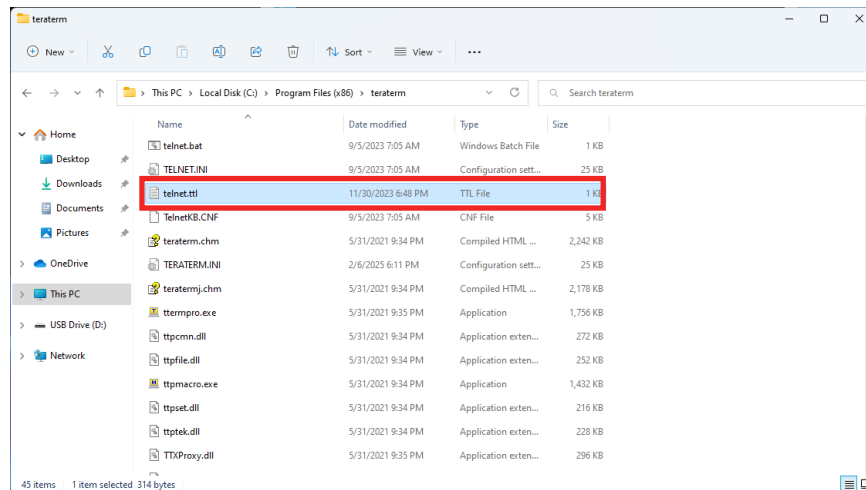

The old IP address

```
show 0
connect '192.168.10.100:50005 /nossh /T=1'
:detpwd
loadkeymap 'TelnetKB.CNF'
wait "Enter Password"
testlink
if result=0 then
  mpause 200
end
```

Change to the new IP address

```
show 0
connect '192.168.10.88:50005 /nossh /T=1'
:detpwd
loadkeymap 'TelnetKB.CNF'
wait "Enter Password"
testlink
if result=0 then
  mpause 200
end
endif
loadkeymap 'KEYBOARD.CNF'
```