

RK701

Rockchip Processor
Qseven

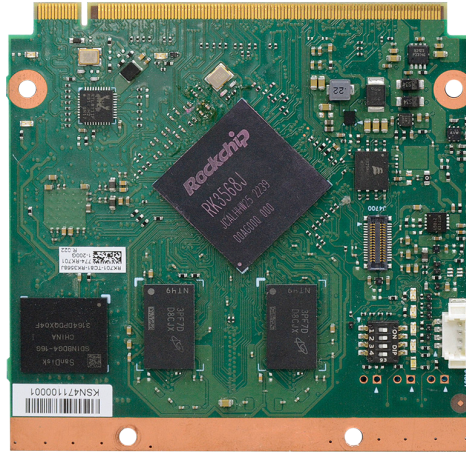

Front View



Bottom View

KEY FEATURES



DDR4

2GB/4GB/8GB DDR4
Memory Down



4K High Resolution

Supports 4K / 2K resolution



Dual Displays

1 eDP/LVDS +
1 DP/TMDS



Multiple Expansion

2 PCIe 3.0, 1 PCIe 2.0



RICH I/O

1 Realtek GbE,
1 USB 3.2, 4 USB 2.0

MECHANICAL DRAWING

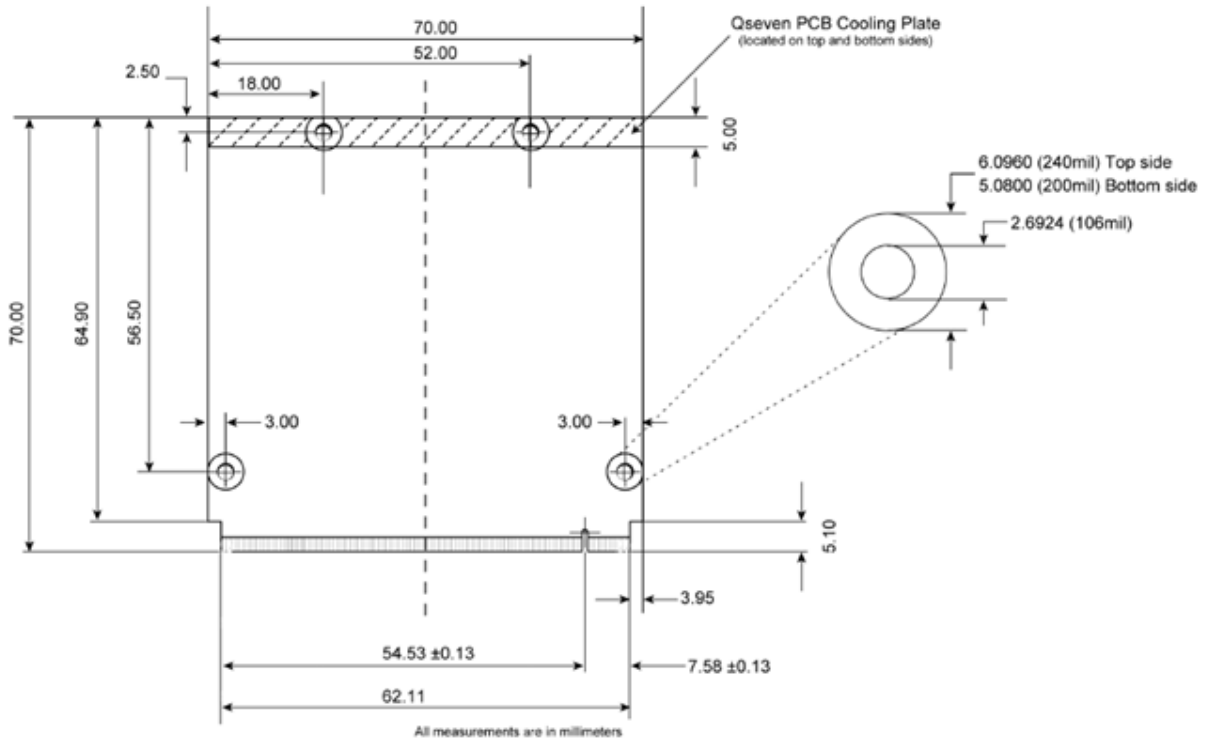

Qseven Module Top Side

SPECIFICATION

SYSTEM	Processor	Rockchip RK3568 quad-core Cortex-A55 @2.0GHz Rockchip RK3568J quad-core Cortex-A55 @1.8GHz	
	Memory	2GB/4GB/8GB DDR4 Memory Down 3200MHZ	
GRAPHICS	Controller	G52 2EE	
	Feature	OpenGL ES1.1/2.0/3.0/3.1/3.2, Vulkan 1.1, OpenCL 2.0	
	Display	1 x eDP/LVDS 1 x DP/TMDS	HDMI: resolution up to 4096 x 2160 @30HZ LVDS: resolution up to 1024 x 600 @60Hz eDP: resolution up to 3840 x 2160 @60Hz
	Dual Displays	eDP/LVDS + DP/TMDS	
EXPANSION	Interface	2 x PCIe x1 (Gen 3) 1 x PCIe x1 (Gen 2) 1 x uSD (available upon request) 1 x I2C 2 x SPI (SPI0 set to TPM 2.0) 1 x CAN bus 2 x UART 1 x MIPI-CSI (available upon request)	
AUDIO	Interface	HD Audio	
ETHERNET	Controller	1 x RTL8211F-CG	
I/O	USB	1 x USB 3.2 4 x USB 2.0	
	SATA	2 x SATA 3.0 (up to 6Gb/s, SATA 1 Co-Lay PCIE Gen 2)	
	eMMC	Supports up to 128GB eMMC, NC as default eMMC 5.1, BGA-153 Ball 8~128G(MLC mode)	
	GPIO	1 x 4-bit GPIO	
SECURITY	TPM	TPM 2.0	
POWER	Type	5V, 5VSB, VCC_RTC	
	Consumption	TBD	
OS SUPPORT (UEFI ONLY)	Linux	Linux	
ENVIRONMENT	Temperature	Operating: 0 to 60°C, -40 to 85°C	
	Humidity	Operating: 5 to 90% RH	Storage: 5 to 90% RH
	MTBF	TBD	
MECHANICAL	Dimensions	Qseven form factor	70mm (2.76") x 70mm (2.76")
	Compliance	Qseven specification revision 2.1	
STANDARDS AND CERTIFICATIONS	Certification	CE, FCC Class B, RoHS	

ORDERING INFORMATION

Model Name	P/N	CPU	Memory	eDP	USB 3.2	USB 2.0	eMMC	Operating Temp.
RK701-BC41-RK3568	770-RK7011-000G	RK3568	4 GB	LVDS	1	4	16GB	0 to 60°C
RK701-BC81-RK3568	770-RK7011-100G	RK3568	8 GB	LVDS	1	4	16GB	0 to 60°C
RK701-TC81-RK3568J	770-RK7011-200G	RK3568J	8 GB	LVDS	1	4	16GB	-40 to 85°C

PACKING LIST

• 1 RK700 board
• 1 Heat sink

OPTIONAL ITEMS

• Qseven Carrier Board
• Heat spreader