



DT122-SD

Q170/
H110



► Features

- 6th/7th Gen Intel Core Desktop Box PC
- 1x 3.5" / 2x 2.5" SATA drive bay
- 1x optional slim ODD bay
- Supports 1 expansion slot: 1 PCIe x16 or 1 PCI

► Panel

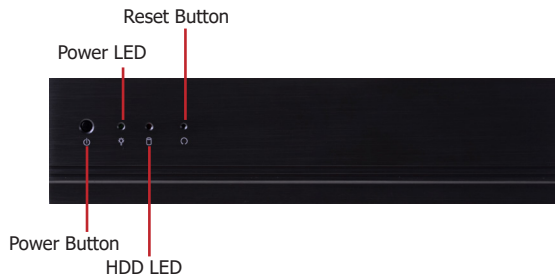

Front View

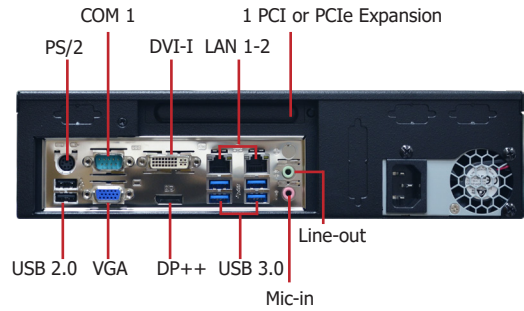

Rear View

► Dimensions

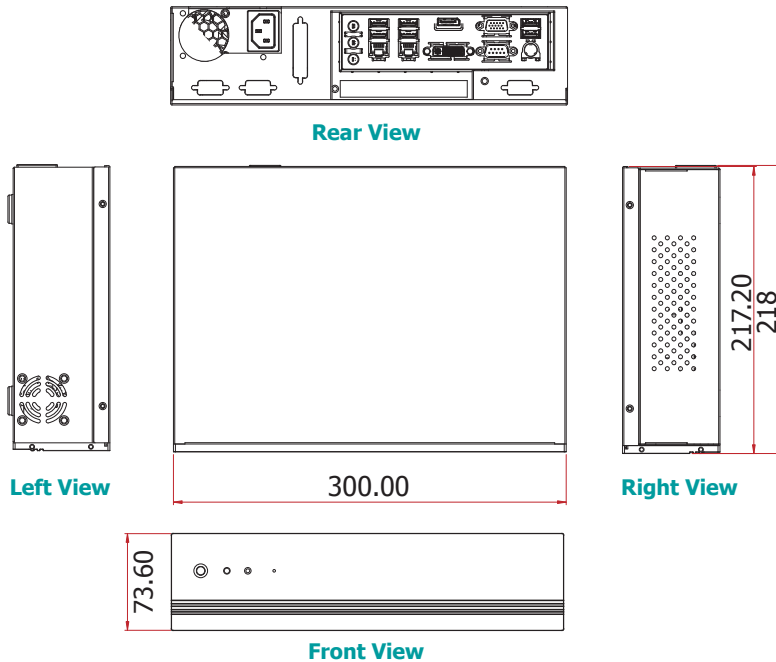

► Specifications

SYSTEM	Processor	6th/7th Generation Intel® Core™ Processors, LGA 1151 Socket Intel® Core™ i7-6700TE, Quad Core, 8M Cache, 2.4GHz (3.4GHz), 35W Intel® Core™ i5-6500TE, Quad Core, 6M Cache, 2.3GHz (3.3GHz), 35W Intel® Core™ i3-6100TE, Dual Core, 4M Cache, 2.7GHz, 35W Intel® Core™ i7-7700T Processor, Quad Core, 8M Cache, 2.9GHz (3.8GHz), 35W Intel® Core™ i5-7500T Processor, Quad Core, 6M Cache, 2.7GHz (3.3GHz), 35W Intel® Core™ i3-7101TE Processor, Dual Core, 3M Cache, 3.4GHz, 35W Intel® Pentium® Processor G4400TE, Dual Core, 3M Cache, 2.4GHz, 35W Intel® Celeron® Processor G3900TE, Dual Core, 2M Cache, 2.6GHz, 35W Intel® Celeron® Processor G3930TE, Dual Core, 2M Cache, 2.7GHz, 35W	
	Chipset	Intel® Q170 Chipset	Intel® H110 Chipset
	Memory	Two 260-pin SODIMM up to 32GB Dual Channel DDR4 1866/2133MHz	
	BIOS	Insyde SPI 128Mbit	
	GRAPHICS	Controller	Intel® HD Gen 9 Graphics
	Feature	OpenGL 5.0, DirectX 12, OpenCL 2.1 HW Decode: AVC/H.264, MPEG2, VC1/WMV9, JPEG/MJPEG, HEVC/H265, VP8, VP9 HW Encode: MPEG2, AVC/H264, JPEG, HEVC/H265, VP8, VP9	
	Display	1 x VGA 1 x DVI-I (DVI-D signal) 1 x DP++	VGA: resolution up to 1920x1200 @ 60Hz DVI-I: resolution up to 1920x1200 @ 60Hz DP: resolution up to 4096x2304 @ 60Hz
	Triple Displays	VGA + DVI-I (DVI-D signal) + DP++ (H110 supports dual displays)	
STORAGE		1 x 3.5" or 2 x 2.5" SATA 3.0 Drive Bay (1 x 2.5" by default) 1 x Slim ODD Bay (available upon request)	
EXPANSION	Interface	1 x PCIe x16 (Gen 3) or 1 x PCI (through optional riser card) Q170: 1 x Half-size Mini PCIe (mSATA/PCIe, PCIe by default) H110: 1 x Full-size Mini PCIe (mSATA/PCIe, PCIe by default)	
AUDIO	Audio Codec	Realtek ALC888S-VD2-GR	
ETHERNET	Controller	Q170: 1 x Intel® I210AT PCIe (10/100/1000Mbps) 1 x Intel® I219LM PCIe with iAMT11.0 (10/100/1000Mbps) (only Core i7/i5 supports iAMT) H110: 1 x Intel® I211AT PCIe (10/100/1000Mbps) 1 x Intel® I219V PCIe (10/100/1000Mbps)	
LED	Indicators	1 x Power LED 1 x HDD LED	
FRONT I/O	Buttons	1 x Power Switch 1 x Reset Switch	
REAR I/O	Ethernet	2 x GbE (RJ-45)	
	Serial	1 x RS-232 (DB-9)	
	USB	4 x USB 3.0 2 x USB 2.0	
	PS/2	1 x PS/2 (mini-DIN-6)	
	Display	1 x VGA 1 x DVI-I (DVI-D signal) 1 x DP++	
	Audio	1 x Line-in (available upon request) 1 x Line-out 1 x Mic-in	
COOLING	Fan	1 x System Fan 1 x CPU Fan	
WATCHDOG TIMER	Output & Interval	System Reset, Programmable via Software from 1 to 255 Seconds	
POWER	Supply	Flex ATX 250W (150W/350W/400W available upon request)	DC-in External Power Adapter (available upon request)
OS SUPPORT		Windows 7 (/WES7) 32/64-bit Windows 8.1 (64-bit) Windows 10 IoT Enterprise 64-bit	Debian 8 (with VESA graphic driver) CentOS 7 (with VESA graphic driver) Linux
MECHANISM	Construction	Front Bezel aluminum + Chassis Sheet Metal	
	Mounting	Wall mount	
	Dimensions (W x H x D)	300mm x 73.6mm x 218mm	
	Weight	3.7 kg	
ENVIRONMENT	Operating Temperature	0 to 45°C	
	Storage Temperature	-20 to 60°C	
	Relative Humidity	0 to 90% RH (non-condensing)	
STANDARDS AND CERTIFICATIONS	Shock	Operating: 3G	Non-operating: 5G
	Vibration	Operating: Random 5~500Hz 1G	Non-operating: Sweep Sine 10~500Hz 1.5G
	Package Drop	ISTA Project 1A	
	Certification	CE, FCC Class A, RoHS	

Wall Mounting

Type A Wall mount bracket

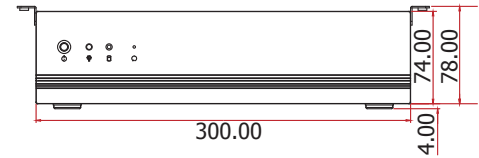
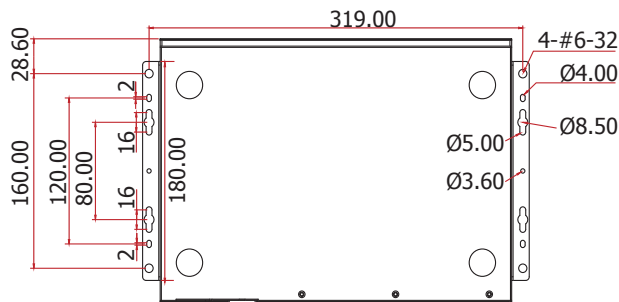
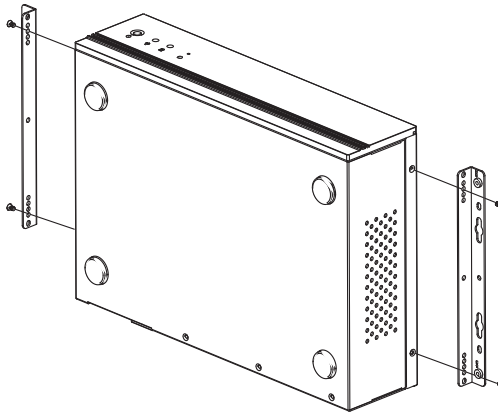

Type B Wall mount bracket

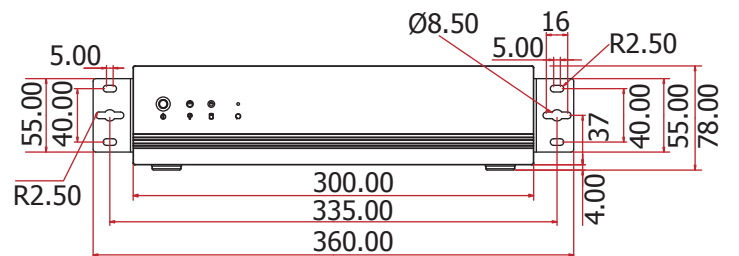
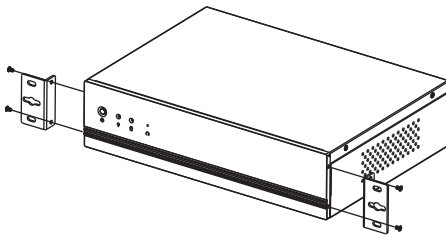

► Ordering Information

Model Name	Part Number	Description
DT122-SD	750-DT1221-000G	DT122-SD: SD100-Q170, 250W PSU, PCIe x16, SYSTEM F/G RoHS
DT122-SD	750-DT1221-100G	DT122-SD: SD100-H110, 250W PSU, PCIe x16, SYSTEM F/G RoHS
DT122-SD	750-DT1221-200G	DT122-SD: SD100-Q170, 250W PSU, PCI, SYSTEM F/G RoHS
DT122-SD	750-DT1221-300G	DT122-SD: SD100-H110, 250W PSU, PCI, SYSTEM F/G RoHS
DT122-SD	750-DT1221-400G	DT122-SD: SD100-Q170, 250W PSU, SYSTEM F/G RoHS
DT122-SD	750-DT1221-500G	DT122-SD: SD100-H110, 250W PSU, SYSTEM F/G RoHS

► Optional Items

Optional Items	Part Number	Description
CPU	785-1151DL	CPU, LGA1151, Long-Term Support, RoHS
Memory	785-RSOD416G	SODIMM, DDR4 Module, 16GB, RoHS
	785-RSOD48G	SODIMM, DDR4 Module, 8GB, RoHS
	785-RSOD44G	SODIMM, DDR4 Module, 4GB, RoHS
HDD	785-H351T0B	3.5" SATA HDD, 1TB, RoHS
	785-H35500G	3.5" SATA HDD, 500GB, RoHS
	785-H25500G	2.5" SATA HDD, 500GB, RoHS
mSATA	785-MS128GMF	mSATA Card, 128GB MLC, RoHS
	785-MS64GMF	mSATA Card, 64GB MLC, RoHS
	785-MS32GMF	mSATA Card, 32GB MLC, RoHS
	785-MS16GMF	mSATA Card, 16GB MLC, RoHS
	785-MS08GMF	mSATA Card, 8GB MLC, RoHS
	785-MS04GMF	mSATA Card, 4GB MLC, RoHS
Wi-Fi	761-110091-000G	Wi-Fi Kit, RoHS
Power Cord	785-PWRD	Power Cord, Standards (USA/EUR/CH), 1.8m, RoHS
Wall Mount	761-DT1220-100G	DT122 Type A Wall Mount Kit for Top Cover, RoHS
	761-DT1220-000G	DT122 Type B Wall Mount Kit for Front Cover, RoHS

► Packing List

• 1 DT122-SD system unit
• 1 CPU cooler
• 1 HDD drive bay kit
• 1 Heatsink/fan
• 1 Quick Installation Guide