



EC500-KH

CM238
QM175



► Features

- Supports DDR4 SODIMM up to 64GB
- Three independent displays: 1 VGA + 1 DVI/HDMI + 1 HDMI/DP
- Rugged and Fanless Embedded System
- Rich I/O connectivity: 2 GbE, 4 COM, 4 USB 3.0, 2 USB 2.0, 1 CFast
- Supports 2 Mini PCIe and 1 M.2 NVMe slots
- Operating Temperature: -20 to 60°C, -40 to 70°C (optional)

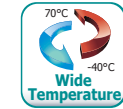

► Panel

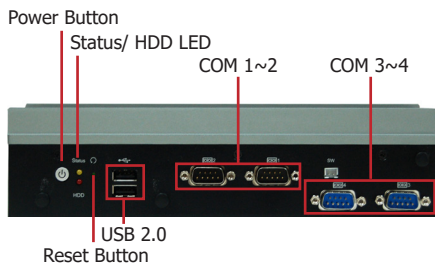

Front View

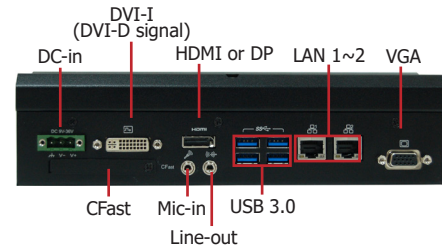

Rear View

► Dimensions

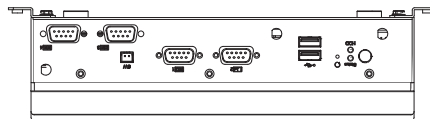

Front View

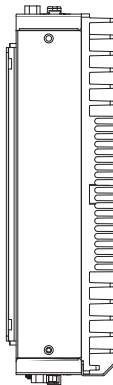

Left View

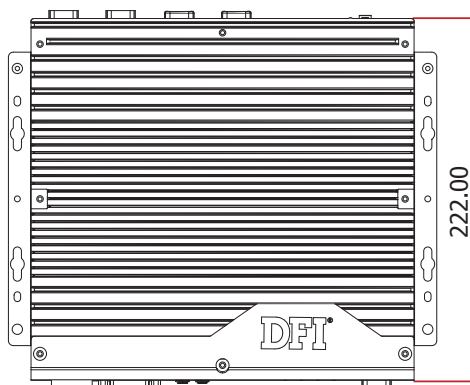

Rear View

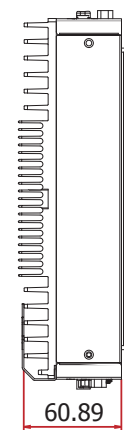

Right View

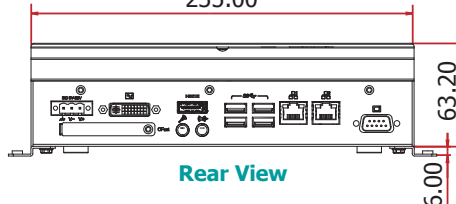

► Specifications

SYSTEM	Processor	7th Generation Intel® Core™ Processors, BGA 1440 Intel® Xeon® Processor E3-1535M v6, Quad Core, 8M Cache, 3.1GHz (4.2GHz), 45W Intel® Core™ i7-7820EQ Processor, Quad Core, 8M Cache, 3.0GHz (3.7GHz), 45W Intel® Core™ i5-7440EQ Processor, Quad Core, 6M Cache, 2.9GHz (3.6GHz), 45W Intel® Core™ i5-7442EQ Processor, Quad Core, 6M Cache, 2.1GHz (2.9GHz), 25W Intel® Core™ i3-7100E Processor, Dual Core, 3M Cache, 2.9GHz, 35W Intel® Core™ i3-7102E Processor, Dual Core, 3M Cache, 2.1GHz, 25W	
	Chipset	Intel® CM238 Chipset Intel® QM175 Chipset	
	Memory	Two 260-pin SODIMM up to 64GB (CM238 supports ECC) Dual Channel DDR4 2400MHz	
	BIOS	Insyde SPI 128Mbit	
GRAPHICS	Controller	Intel® HD Graphics	
	Feature	OpenGL up to 5.0, DirectX 11, OpenCL 2.1 HW Decode: HEVC/H.265, H.264, M/JPEG, MPEG2, VC1/WMV9, VP8 (8-bit), VP9 (10-bit) HW Encode: HEVC/H.265, M/JPEG, MPEG2, VP8	
	Display	1 x VGA 1 x HDMI/DVI (DVI-D signal) (DVI available upon request) 1 x HDMI/DP++ (DP++ available upon request)	VGA: resolution up to 1920x1200 @ 60Hz DVI: resolution up to 1920x1200 @ 60Hz HDMI: resolution up to 4096x2160 @ 24Hz DP++: resolution up to 4096x2304 @ 60Hz
	Triple Displays	VGA + HDMI/DVI (DVI-D signal) + HDMI/DP++	
STORAGE	Internal	1 x 2.5" SATA 3.0 Drive Bay 1 x CFast Socket	
EXPANSION	Interface	1 x Full-size Mini PCIe with micro SIM socket (PCIe/USB) 1 x Full-size Mini PCIe with micro SIM socket (USB) 1 x M.2 2280 M key (PCIe x4 NVMe, Intel optane memory support)	
ETHERNET	Controller	1 x Intel® I211AT PCIe (10/100/1000Mbps) 1 x Intel® I219LM with iAMT11.0 PCIe (10/100/1000Mbps) (only Core i7/i5 supports iAMT)	
LED	Indicators	1 x Power LED 1 x Status LED 1 x HDD LED	
FRONT I/O	Serial	2 x RS-232/422/485 (DB-9) (RS-232 with power) 2 x RS-232/422/485 (DB-9)	
	USB	2 x USB 2.0 (type A)	
	Buttons	1 x Power button 1 x Reset button	
	Antenna	3 x Antenna hole	
REAR I/O	Ethernet	2 x GbE (RJ-45)	
	USB	4 x USB 3.0 (type A)	
	Display	1 x VGA 1 x HDMI/DVI (DVI-D signal) (DVI available upon request) 1 x HDMI/DP++ (DP++ available upon request)	
	Audio	1 x Line-out 1 x Mic-in (available upon request)	
WATCHDOG TIMER	Output & Interval	System Reset, Programmable via Software from 1 to 255 Seconds	
SECURITY	TPM	TPM 2.0 (optional)	
POWER	Type	Wide range 9~36V	
	Connector	3-pole terminal block 2-pin power extension switch connector	
OS SUPPORT	Microsoft	Windows 10 IoT Enterprise 64 Bit	
	Linux	Linux (available upon request)	
MECHANISM	Construction	Metal + Aluminum	
	Mounting	Wall mount	
	Dimensions (W x H x D)	235 x 60.89 x 222mm	
	Weight	3.5kg	
ENVIRONMENT	Operating Temperature	0 to 50°C (HDD) -20 to 60°C (SSD) -40 to 70°C (optional)	
	Storage Temperature	-20 to 85°C	
	Relative Humidity	5 to 95% RH (non-condensing)	
STANDARDS AND CERTIFICATIONS	Shock	Half sine wave 3G, 11ms, 3 shock per axis	
	Vibration	IEC68-2-64	
	Certification	CE, FCC Class A, Microsoft Azure	

All product specifications are subject to change without notice.

Wall Mounting

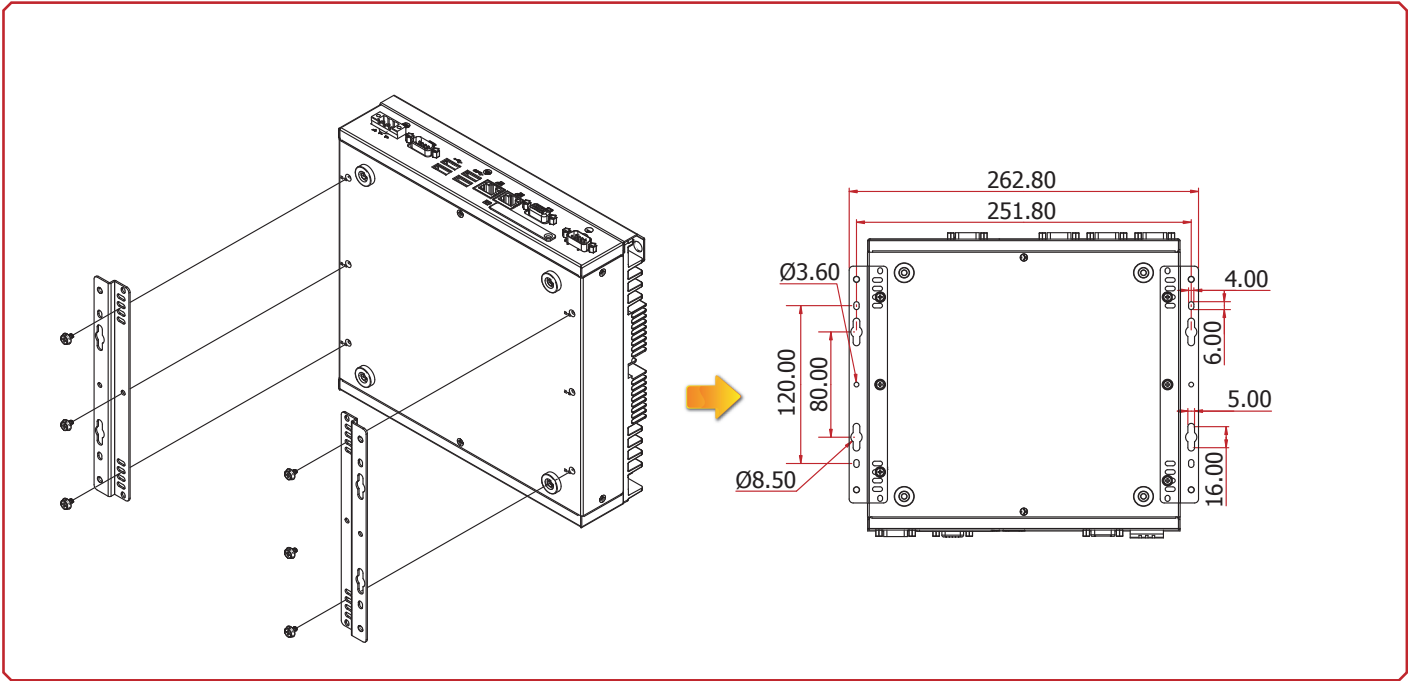

► Ordering Information

Model Name	Part Number	Description
EC500-KH	750-EC5002-000G	EC500-KH Fanless, KH263-QM175, I7-7820EQ, VGA/DVI/HDMI, 4 COM, 6 USB, 2 LAN DC 9~36V input, F/G SYSTEM RoHS, Op. temp. -40 to +70°C
EC500-KH	750-EC5002-100G	EC500-KH Fanless, KH263-QM175, I3-7102E, VGA/DVI/HDMI, 4 COM, 6 USB, 2 LAN DC 9~36V input, F/G SYSTEM RoHS, Op. temp. -40 to +70°C
EC500-KH	750-EC5002-200G	EC500-KH Fanless, KH263-CM238, E3-1535M v6, VGA/DVI/HDMI, 4 COM, 6 USB, 2 LAN, DC 9~36V input, F/G SYSTEM RoHS, Op. temp. -20 to +60°C
EC500-KH	750-EC5002-300G	EC500-KH Fanless, KH263-QM175, I5-7440EQ, VGA/DVI/DP, 4 COM, 6 USB, 2 LAN, DC 9~36V input, F/G SYSTEM RoHS, Op. temp. -40 to +70°C

► Optional Items

Optional Items	Part Number	Description
SO-DIMM	138-540002-106G	4GB DDR4 2666Mhz SO-DIMM 1Rx8 512Mx8 CL19 1.2V
	138-580004-102G	8GB DDR4 2666Mhz SO-DIMM 1Rx8 1Gx8 CL19 1.2V
	138-5G0163-102G	16GB DDR4 2666Mhz SO-DIMM 2Rx8 1Gx8 CL19 1.2V
	TBD	32GB DDR4 2666Mhz SO-DIMM 2Rx8 2Gx8 CL19 1.2V
	TBD	4GB DDR4 2666Mhz SO-DIMM 1Rx8 512Mx8 CL19 1.2V, wide temp.
	138-580004-104G	8GB DDR4 2666Mhz SO-DIMM 1Rx8 IND 1Gx8 CL19 1.2V, wide temp.
	138-5G0163-103G	16GB DDR4 2666Mhz SO-DIMM 2Rx8 IND 1Gx8 CL19 1.2V, wide temp.
	TBD	32GB DDR4 2666Mhz SO-DIMM 2Rx8 IND 2Gx8 CL19 1.2V, wide temp.
	138-540002-107G	4GB DDR4 2666Mhz ECC-SO-DIMM 1Rx8 512Mx8 CL19 1.2V
	138-580004-103G	8GB DDR4 2666Mhz ECC-SO-DIMM 1Rx8 1Gx8 CL19 1.2V
	TBD	16GB DDR4 2666Mhz ECC-SO-DIMM 2Rx8 1Gx8 CL19 1.2V
	TBD	32GB DDR4 2666Mhz ECC-SO-DIMM 2Rx8 2Gx8 CL19 1.2V
M.2 SSD	785-M2PCIE032G	32GB, M.2 2280 SSD, PCIE x4, M Key, TLC, RoHS
	785-M2PCIE064G	64GB, M.2 2280 SSD, PCIE x4, M Key, TLC, RoHS
	785-M2PCIE128G	128GB, M.2 2280 SSD, PCIE x4, M Key, TLC, RoHS
	785-M2PCIE256G	256GB, M.2 2280 SSD, PCIE x4, M Key, TLC, RoHS
2.5" SSD	785-S25032G	32GB, 2.5" SSD, SATA3, MLC, RoHS
	785-S25064G	64GB, 2.5" SSD, SATA3, MLC, RoHS
	785-S25128G	128GB, 2.5" SSD, SATA3, MLC, RoHS
	785-S25256G	256GB, 2.5" SSD, SATA3, MLC, RoHS
	785-S25512G	512GB, 2.5" SSD, SATA3, MLC, RoHS
CFast	785-CFS256G	256GB CFast, RoHS
	785-CFS128G	128GB CFast, RoHS
	785-CFS64G	64GB CFast, RoHS
	785-CFS32G	32GB CFast, RoHS
	785-CFS16G	16GB CFast, RoHS
	785-CFS8G	8GB CFast, RoHS



► Optional Items

Optional Items	Part Number	Description
Wi-Fi/BT Kit	612-WPEQ26-000G	MINI-CARD 802.11ac/a/b/g/n+BT, 2T2R, WPEQ-261ACN(BT), SPARKLAN
Power Cord	785-PWRD	Power Cord, Standards (USA/EUR/CH/UK), 1.8m, RoHS
Power Adapter	671-110002-100G	100W, 12V, Level 6, RoHS
	671-110003-100G	120W, 19V, Level 6, RoHS
	671-112005-100G	120W, 24V, Level 6, Wide Temp, RoHS
	671-116003-000G	160W, 19V, Level 6, RoHS
Wall Mount	761-EC5410-000G	Wall Mount Kit, RoHS

► Packing List

• 1 EC500-KH system unit
• 1 Extend power switch cable
• 1 terminal block 3pole for DC input
• 1 cable with 2 wire stripped and tinned to DC jack