



3rd/2nd Gen Intel® Core™□
Desktop Box PC

DT122-SB

Q67



Features

- Supports DDR3 DIMM up to 16GB
- Up to 2x 2.5" or 1x 3.5" SATA drive bay
- 1 DVI-I, 1 VGA, 4 USB 2.0, 2 LAN, 2 COM
- Dual independent display



Optional
Optical Drive



Panel

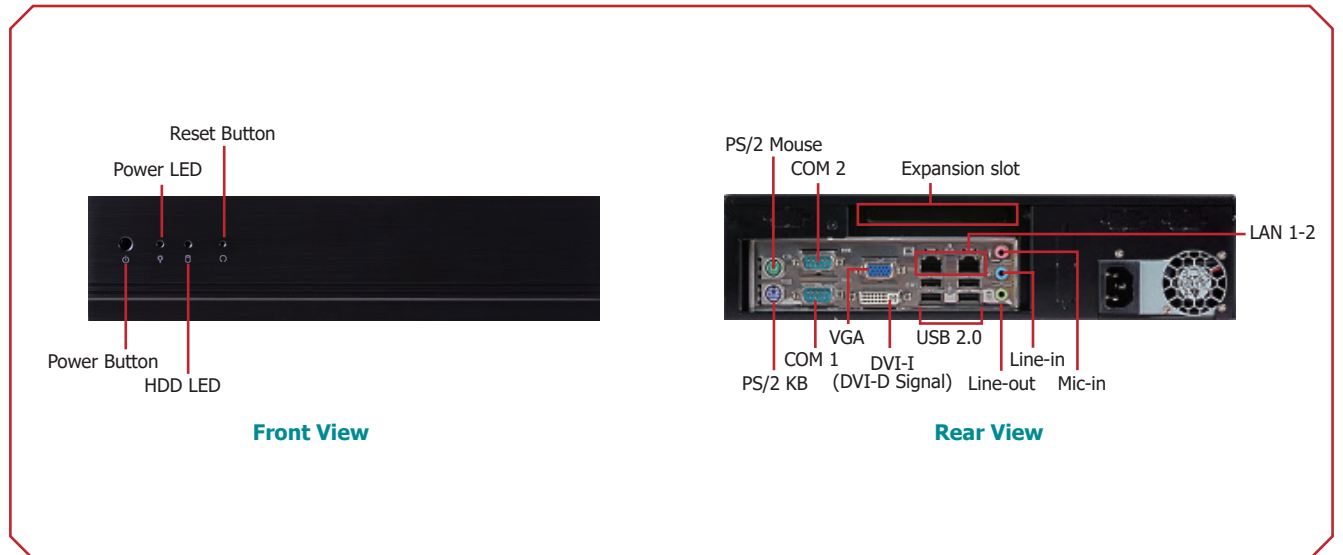

Dimensions

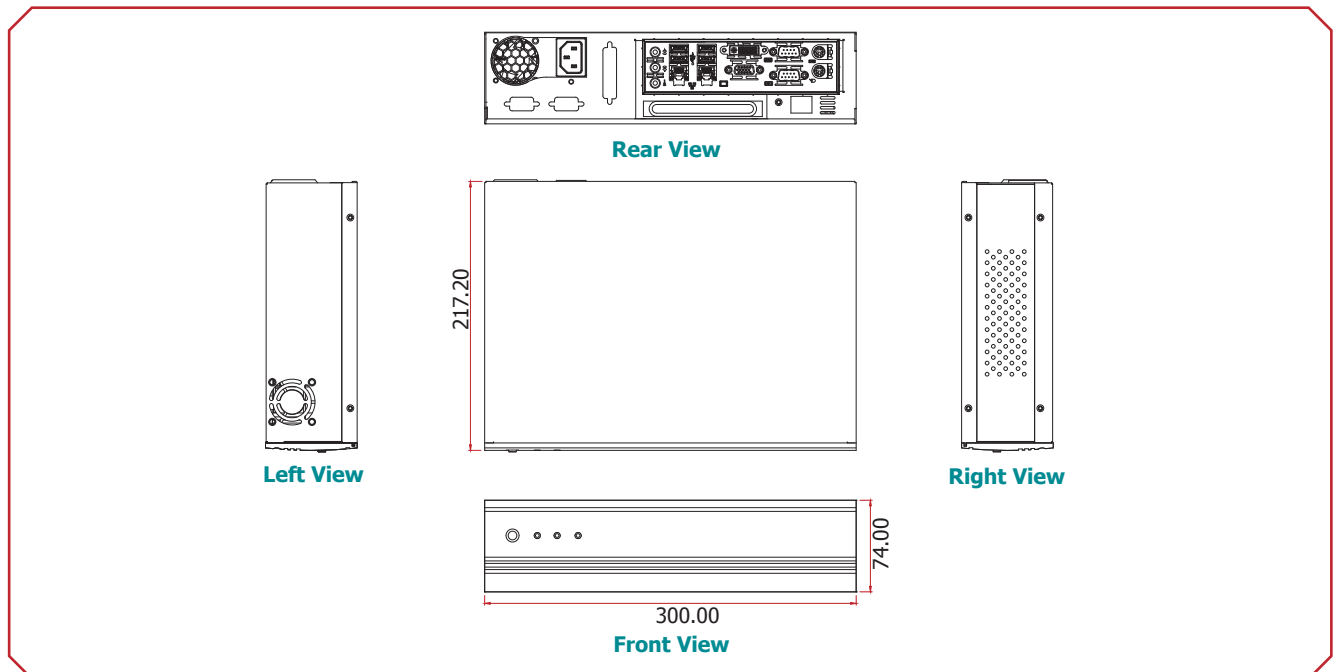

DT122-SB

► Specifications

PROCESSOR SYSTEM

- Processors:
 - 3rd generation Intel® Core™ processors (22nm process technology)
 - Intel® Core™ i5-3550S (6M Cache, up to 3.7GHz); 65W
 - Intel® Core™ i3-3220 (3M Cache, 3.3GHz); 55W
 - Intel® Pentium® G2120 (3M Cache, 3.1 GHz); 65W
 - 2nd generation Intel® Core™ processors (32nm process technology)
 - Intel® Core™ i3-2120 (3M Cache, 3.3 GHz); 65W
 - Intel® Pentium® G850 (3M Cache, 2.9 GHz); 65W
- Chipset: Intel® Q67 Express chipset

MEMORY

- Two DDR3 DIMM sockets
- Supports DDR3 1333/1600MHz (3rd generation processors)
Supports DDR3 1066/1333MHz (2nd generation processors)
- Supports up to 16GB memory

GRAPHICS

- Intel® HD Graphics
- Display ports: DVI-I (DVI-D signal) and VGA
- DVI-I supports up to 1920x1200 @ 60Hz resolution
- VGA supports up to 2048x1536 @ 75Hz resolution

STORAGE

- Up to 2 2.5" or 1 3.5" SATA drive bay
- 1 optical drive bay (optional)

ETHERNET

- Intel® W82579LM with iAMT8.0 Gigabit Ethernet Phy
- Intel® W82574L PCI Express Gigabit Ethernet controller

AUDIO

- Realtek® ALC262 2-channel High Definition Audio

COM

- 2 DB-9 RS232/422/485 COM ports
- 2 DB-9 RS232 COM ports (optional)

USB

- 4 Type A USB 2.0/1.1 ports
- 2 Type A USB 2.0/1.1 ports (optional)

I/O PORTS

- Front Panel
 - 1 Power button
 - 1 Reset button
 - 2 LED indicators: Power, HDD
- Rear Panel
 - 1 PS/2 Mouse
 - 1 PS/2 Keyboard
 - 2 DB-9 RS232/422/485 COM
 - 1 DB-15 VGA
 - 1 DVI-I (DVI-D signal)
 - 2 RJ45 LAN
 - 4 USB 2.0
 - Mic-in, Line-in and Line out

EXPANSION

- 1 expansion slot
 - 1 PCIe x16 or 1 PCI slot

POWER

- Power type
 - ATX
- Power input voltage
 - AC 100-240V, 3.5A, 250W

COOLING SYSTEM

- 1 CPU cooler

ENVIRONMENT

- Temperature
 - Operating: 0°C ~ 45°C
 - Storage: -20°C ~ 60°C
- Humidity
 - 90% RH at 45°C, 1 week

VIBRATION

- Operating: 1G, 5~500Hz
- Non-operating: 1.5G, 5~25Hz
- IEC 68-2-64 compliant

SHOCK

- Operating: 3G peak acceleration (11 msec. duration)
- Non-operating: 10G peak acceleration (11 msec. duration)
- IEC 68-2-27 compliant

CONSTRUCTION

- Front panel: aluminum
- Rear chassis: sheet metal

MOUNTING

- 2 types of wall mount bracket
 - Type A
 - Type B

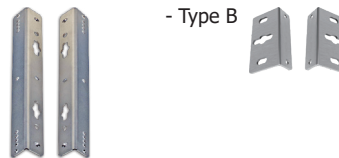

- Brackets and screws (optional)

DIMENSIONS

- 300mm x 75mm x 217mm (W x H x D)

WEIGHT

- 4.04 kg

OS SUPPORT

- Windows 7, Windows 7 Embedded, Windows XP,
Windows XP Embedded, Linux Kernel 2.6

CERTIFICATION

- CE
- FCC Class B
- RoHS



DT122-SB

▶ Wall Mounting

Type A Wall mount bracket

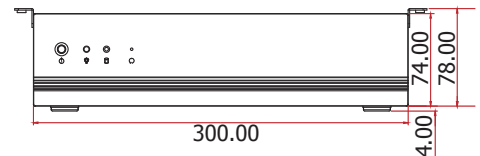
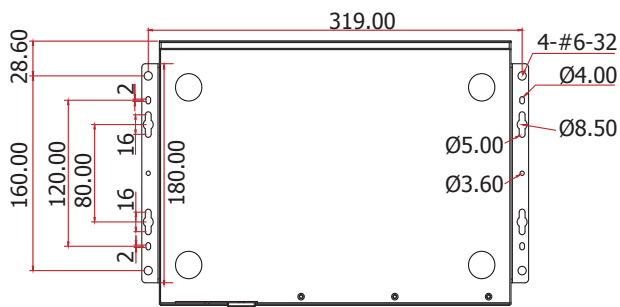
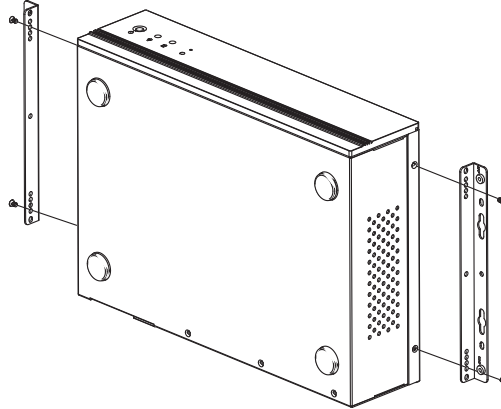

Type B Wall mount bracket

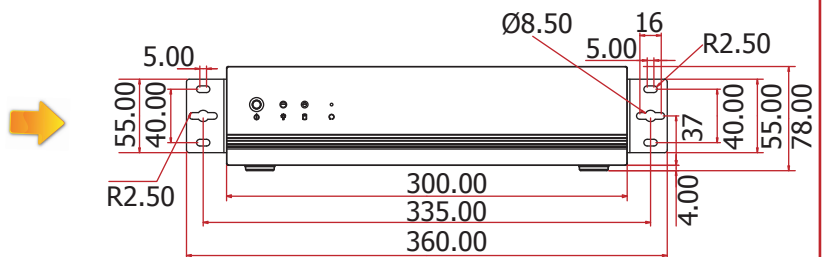
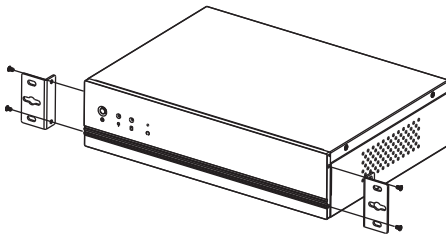

DT122-SB

► Ordering Information

Model Name	Part Number	Description
DT122-SB	750-DT1220-000G	DT122-SB: SB100 RoHS
	750-DT1220-500G	DT122-SB: W/DVD SB100 RoHS
	750-DT1220-020G	DT122-SB: SB100, RoHS, with 1 PCI expansion
	750-DT1220-010G	DT122-SB: SB100, RoHS, with 1 PCIe x16 expansion

► Optional Items

Optional Items	Part Number	Description
CPU	785-CP1155DL	CPU, LGA 1155, Long-term support, RoHS
Memory	785-RL0D38G-L	Long DIMM, DDR3L Module (supports dual voltage 1.5V DDR3/1.35V DDR3L), 8GB, RoHS
	785-RL0D34G-L	Long DIMM, DDR3L Module (supports dual voltage 1.5V DDR3/1.35V DDR3L), 4GB, RoHS
	785-RL0D32G	Long DIMM, DDR3, 2GB, RoHS
HDD	785-H353T0B	3.5" SATA HDD, 500GB, RoHS
	785-H25500G	2.5" SATA HDD, 500GB, RoHS
	785-H25320G	2.5" SATA HDD, 320GB, RoHS
	785-S251TBG	2.5" SATA SSD, 1TB MLC, RoHS
	785-S25512G	2.5" SATA SSD, 512GB MLC, RoHS
	785-S25256G	2.5" SATA SSD, 256GB MLC, RoHS
	785-S25128G	2.5" SATA SSD, 128GB MLC, RoHS
	785-S25064G	2.5" SATA SSD, 64GB MLC, RoHS
Power Cord	785-PWRD	Power Cord, Standards (USA/EUR/CH), 1.8m, RoHS
Wall Mount	761-DT1220-100G	DT122 Type A Wall Mount Kit for Top Cover, RoHS
	761-DT1220-000G	DT122 Type B Wall Mount Kit for Front Cover, RoHS

► Packing List

• 1 DT122 system unit
• 1 CPU cooler
• 1 HDD drive bay kit
• 1 Quick Installation Guide