

KEY FEATURES



High Performance CPU

Intel® Coffee Lake Core i7 processor



802.3af PoE Ports

4x RJ45 or M12 type PoE ports at 15W



AI Accelerated

Support up to 150W MXM GPU module

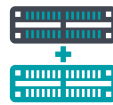

Scalability

Multiple expansion slots for 4G/LTE/5G cellular support



Support 5G Communication

Support M.2 B key 3042/3052 5G-NR module



Wide-Temperature

Up to -20°C~70°C operation without active fan



PANEL

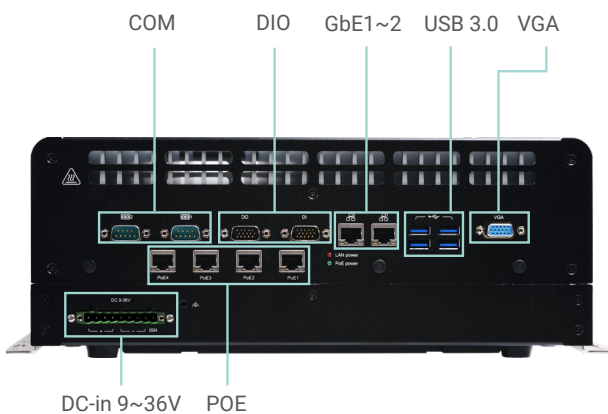

Front View

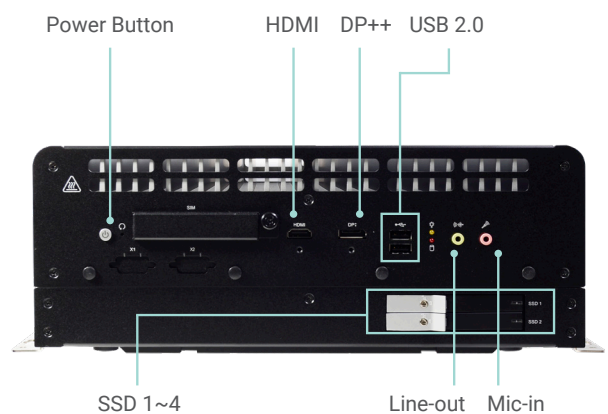

Rear View

DIMENSIONS

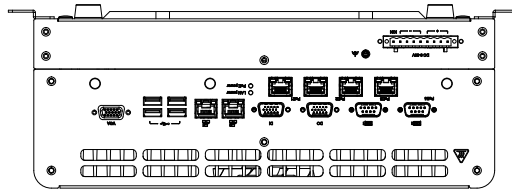

Front View

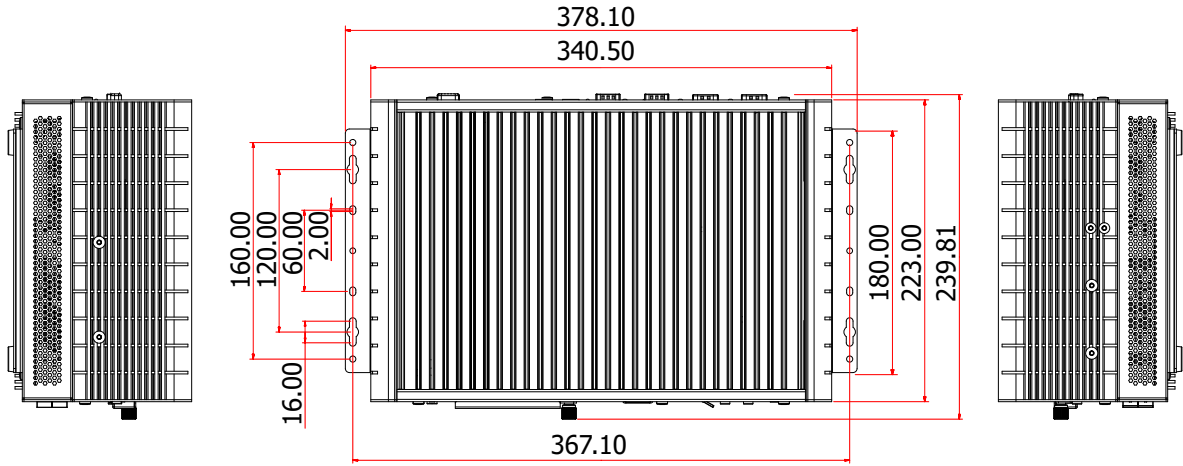

Left View

Right View

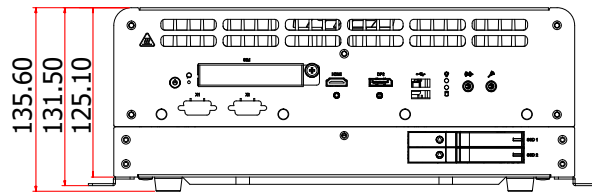

Rear View

WALL MOUNTING

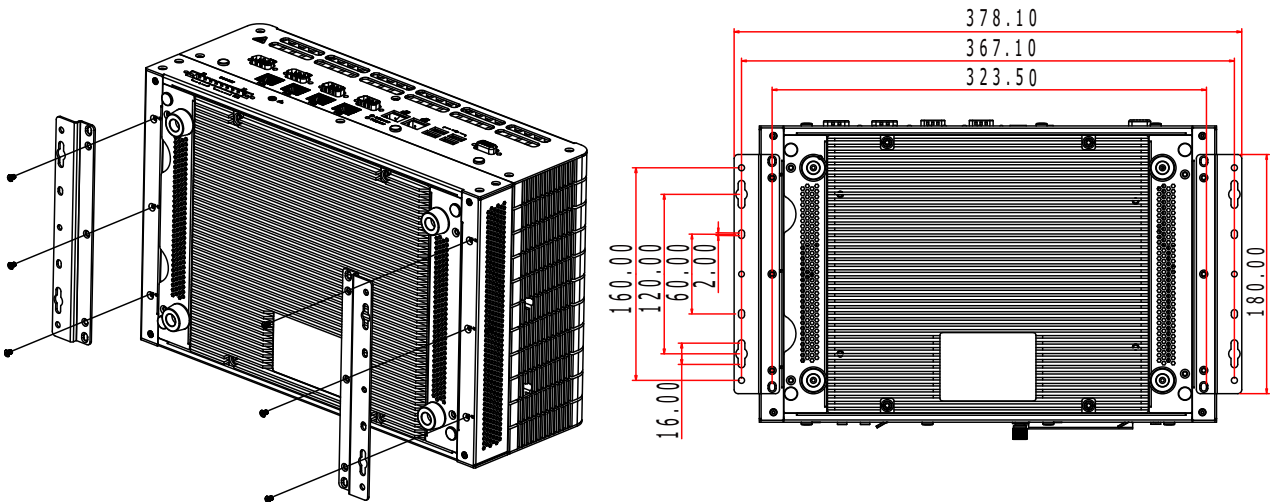

SPECIFICATION

SYSTEM	Processor	8th/9th Generation Intel® Core™ Processors, LGA 1151 Intel® Core™ i7-9700TE 8C/8T 1.8GHz 12MB cache, TDP 35W with Q370PCH Intel® Core™ i7-8700T 6C/12T 2.4GHz 12MB cache, TDP 35W with Q370PCH Intel® Core™ i7-9700E 8C/8T 2.6GHz 12MB cache, TDP 65W with Q370PCH Intel® Core™ i5-9500TE 6C/6T 2.2GHz 9MB cache, TDP 35W with Q370PCH (Other CPU support upon request)
	Chipset	Intel® Q370 Chipset
	Memory	Dual Channel DDR4 2666/2400 MHz by SODIMMs up to 64GB
	BIOS	AMI SPI 128Mbit
GRAPHICS	Controller	Intel® HD Graphics
	Display	1 x VGA (display out by DB-15 connector) 1 x HDMI (with screw lock) 1 x DP++ (standard display port connector DIP type with screw lock) Support NVIDIA Optimus technology VGA: resolution up to 1920x1200@60Hz HDMI: resolution up to 4096x2160@24Hz DP++: resolution up to 4096x2304@60Hz
AI ACCELERATOR	Interface	MXM Type A, B, C on x16 PCIe 3.0
	Controller	Nvidia Quadro embedded/ Geforce series
STORAGE	External	2 x Swappable 2.5" 7mm SSD storage bays with lock
	Internal	1 x M.2 2280 M key supports SATA SSD
EXPANSION	Interface	1 x Half-size Mini PCIe for WiFi/BT modules, with PCIe x1 & USB signal 2 x Full-size Mini PCIe support PCIe x1, USB 2.0 signal with SIM card socket of each 1 x M.2 B key supports 3042, 3052 devices or 5G module on PCIe x1, USB2.0, USB3.0 signal with SIM card slot bracket - SIM card can all be external accessible 1 x M.2 2280 M key supports 2242, 2260 & 2280 devices (PCIe x4 & SATA signal, support boot up function)
AUDIO	Audio Codec	Realtek ALC888
	Interface	1 x Mic-in 1 x Line-out
ETHERNET	Controller	5 x Intel® I210IT NIC (10/100/1000Mbps) 1 x Intel® I219LM with iAMT11.0 PCIe (10/100/1000Mbps) (only Core i7/i5 supports iAMT)
	Interface	2 x RJ45 GbE 4 x RJ45 802.3af 15W PoE ports
LED	Indicators	1 x Power LED (green) 5 x Storage LED (red) 4 x PoE LED
FRONT I/O	PoE	4 x PoE ports at RJ45 or M12 X-coded connectors Support 802.3af, max 15.4W (PSE side) NOT support Wake on Lan
	Ethernet	2 x GbE (RJ-45) support Wake on Lan
	Serial	2 x High speed full RS-232/422/485 (DB-9) 2 x RS-232/422/485 (pin headers)
	DIO	1 x 8bit isolated DI port by DB-9 connector 1 x 8bit isolated DO port by DB-9 connector 2KV isolation
	Display	1 x VGA display out by DB15 connector
	USB	4 x USB 3.0 (type A)
	Power-in	1 x 9pins 5.0mm terminal block
REAR I/O	USB	2 x USB 2.0 (type A)
	Display	1 x HDMI 1 x DP++
	Audio	1 x Mic-in 1 x Line-out by 3.5mm 3P phone jack
	Buttons	1 x Power button 1 x Reset button
	SIM	3 x SIM sockets (external accessible with cover)
	Antenna Holes	7 x SMA type antenna hole for GNSS, WWAN/LTE MIMO, WLAN/ BT MIMO, 5G
	WATCHDOG TIMER	Output & Interval
SECURITY	TPM	TPM 2.0
POWER	Type	+12VDC (9~36V), +24VDC(14.4~33.6) +12V and +24V compliant to eMark with power ignition function Reverse polarity protection
	Connector	9-pin 5.0mm terminal block
OS SUPPORT	Microsoft	Windows 10 IoT Enterprise 64 Bit
	Linux	Ubuntu 18.04
MECHANISM	Construction	Metal + Aluminum
	Mounting	Wall mount
	Dimensions (W x H x D)	340.5 x 132 x 223mm (3U height, excluding rubber foot)
	Weight	9.85 kg

SPECIFICATION

ENVIRONMENT	Operating Temperature	-20°C to 70°C when CPU+GPU<100W without fan -20°C to 60°C when CPU+GPU<160W without fan -20°C to 70°C when CPU+GPU<190W with active fan CPU & GPU will be throttling at high temperature
	Storage Temperature	-40 to 85°C
	Relative Humidity	10% to 90% (non-condensing)
STANDARDS AND CERTIFICATIONS	Shock (SSD/HDD)	MIL-STD-810G Method 516.6, Procedure 1, OP:10G 11ms, Non-OP: 40G 11ms (Test by SSD, HDD is not support)
	Vibration	MIL-STD-810G Method 514.6C-3, Category 4 Composite wheeled vehicle Table 514.6C-VI
	Certification	CE, FCC, UKCA, RoHS, E-Mark

COMPATIBLE MXM MODULES

GPU	MXM Type	Architecture	Memory	TFLOPS	TGP
T1000	A	Turing	4GB GDDR6	2.6	50W
RTX 3000	B	Turing	6GB GDDR6	5.3	80W
RTX A500	A	Ampere	4GB GDDR6	6.54	35W
RTX A1000	A	Ampere	4GB GDDR6	6.66	60W
RTX A2000	A	Ampere	8GB GDDR6 with ECC	8.64	60W
RTX A4500	B+	Ampere	16GB GDDR6 with ECC	17.66	115W

OPTIONAL ITEMS

Optional Items	Part Number	Description
2.5" SSD	785-S251TBG	2.5" SATA SSD, 1TB MLC, -40 to 85°C, RoHS
	785-S25512G	2.5" SATA SSD, 512GB MLC, -40 to 85°C, RoHS
	785-S25256G	2.5" SATA SSD, 256GB MLC, -40 to 85°C, RoHS
	785-S25128G	2.5" SATA SSD, 128GB MLC, -40 to 85°C, RoH
M.2 SATA SSD	785-M2SATA64G	64GB, M.2 2280 SSD, SATA3 B+M Key, MLC, Wide Temp.
	785-M2SATA128G	128GB, M.2 2280 SSD, SATA3 B+M Key, MLC, Wide Temp.
	785-M2SATA256G	256GB, M.2 2280 SSD, SATA3 B+M Key, MLC, Wide Temp.
	785-M2SATA512G	512GB, M.2 2280 SSD, SATA3 B+M Key, 3D TLC, PE: 3K, 30u" -20~75
Memory	138-580004-104G	8GB DDR4 2666Mhz SO-DIMM 1Rx8 IND 1Gx8 CL19 1.2V
	138-540002-121G	4GB DDR4 2666Mhz SO-DIMM, -40 to 85C
WiFi/BT module kit	761-AP1235-000G	WiFi/Bluetooth Module ENL-R8852BE, antenna *2, 200mm SMA cables*2, Mini PCIe Bracket, screws
LTE module kit	761-RC3000-001G	EG25GGB CAT4 miniPCIe module, antenna*2, 300mm SMA cables*2
5G module kit	761-RC3000-100G	RM520N-GL-M2 M.2 module, antenna*4, 184mm SMA cables *4
M12 Cable	A81-005038-054G	8-pin M12 X-coded to RJ45 PoE cable
CAN bus module	770-MPEC21-100G	MPE-CAN2 MiniPCIe Full CAN Module Card Assembly

PACKING LIST

• 1 VC300-CS system unit
• 1 Power connector
• 1 Mounting bracket