

DFI

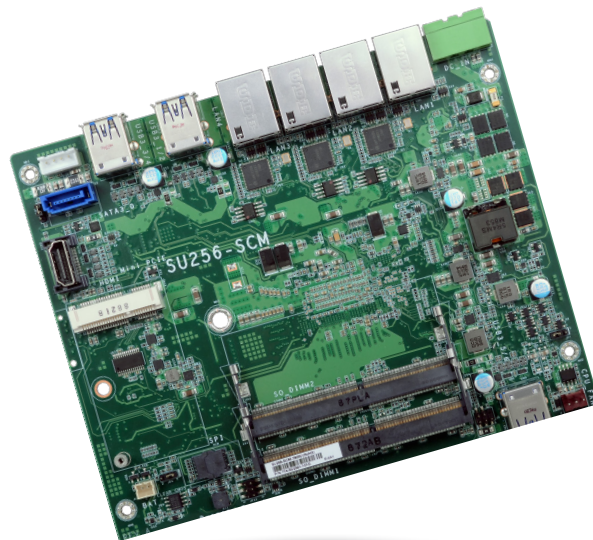

SU256-SCM Embedded SBC 4" User's Manual

Copyright

This publication contains information that is protected by copyright. No part of it may be reproduced in any form or by any means or used to make any transformation/adaptation without the prior written permission from the copyright holders.

This publication is provided for informational purposes only. The manufacturer makes no representations or warranties with respect to the contents or use of this manual and specifically disclaims any express or implied warranties of merchantability or fitness for any particular purpose. The user will assume the entire risk of the use or the results of the use of this document. Further, the manufacturer reserves the right to revise this publication and make changes to its contents at any time, without obligation to notify any person or entity of such revisions or changes.

Changes after the publication's first release will be based on the product's revision. The website will always provide the most updated information.

© 2019. All Rights Reserved.

Trademarks

Product names or trademarks appearing in this manual are for identification purpose only and are the properties of the respective owners.

FCC and DOC Statement on Class B

This equipment has been tested and found to comply with the limits for a Class B digital device, pursuant to Part 15 of the FCC rules. These limits are designed to provide reasonable protection against harmful interference when the equipment is operated in a residential installation. This equipment generates, uses and can radiate radio frequency energy and, if not installed and used in accordance with the instruction manual, may cause harmful interference to radio communications. However, there is no guarantee that interference will not occur in a particular installation. If this equipment does cause harmful interference to radio or television reception, which can be determined by turning the equipment off and on, the user is encouraged to try to correct the interference by one or more of the following measures:

- Reorient or relocate the receiving antenna.
- Increase the separation between the equipment and the receiver.
- Connect the equipment into an outlet on a circuit different from that to which the receiver is connected.
- Consult the dealer or an experienced radio TV technician for help.

Notice:

1. The changes or modifications not expressly approved by the party responsible for compliance could void the user's authority to operate the equipment.
2. Shielded interface cables must be used in order to comply with the emission limits.

Table of Contents

Copyright.....	2
Trademarks	2
FCC and DOC Statement on Class B.....	2
Warranty.....	4
Static Electricity Precautions.....	4
Safety Measures	4
Before Using the System Board.....	5
Chapter 1 - Introduction	6
Specifications	6
Features.....	7
Chapter 2 - Hardware Installation.....	8
Board Layout.....	8
Block Diagram.....	9
Mechanical Diagram	9
System Memory.....	10
Jumper Settings	10
Clear CMOS.....	10
Auto Power-on Select.....	11
Mini PCIe Signal Select	11
Front Panel I/O Ports.....	12
Rear Panel I/O Ports.....	12
15~36V DC-in	13
Graphics Interface	13
USB Ports.....	14
RJ45 LAN Ports.....	15
I/O Connectors.....	16
Serial ATA Connector	16
Serial ATA Power Connector	16
Expansion Slot.....	16
Cooling Fan Connector.....	17
SMBus Connector	17
Front Panel Connector	18
Battery.....	19
Chapter 3 - BIOS Setup.....	20

Overview.....	20
Insyde BIOS Setup Utility.....	21
Main	21
Advanced	21
Security.....	29
Boot.....	30
Exit.....	31
Updating the BIOS	31
Notice: BIOS SPI ROM	32
Chapter 4 - Supported Software	33
Chapter 5 - RAID.....	48
Chapter 6 - Intel AMT Settings.....	51
Overview	51
Enable Intel® AMT in the Insyde BIOS.....	51
Configure Intel® AMT in the Intel® Management Engine BIOS Extension (MEBX) Section	52

Warranty

1. Warranty does not cover damages or failures that arised from misuse of the product, inability to use the product, unauthorized replacement or alteration of components and product specifications.
2. The warranty is void if the product has been subjected to physical abuse, improper installation, modification, accidents or unauthorized repair of the product.
3. Unless otherwise instructed in this user's manual, the user may not, under any circumstances, attempt to perform service, adjustments or repairs on the product, whether in or out of warranty. It must be returned to the purchase point, factory or authorized service agency for all such work.
4. We will not be liable for any indirect, special, incidental or consequential damages to the product that has been modified or altered.

Static Electricity Precautions

It is quite easy to inadvertently damage your PC, system board, components or devices even before installing them in your system unit. Static electrical discharge can damage computer components without causing any signs of physical damage. You must take extra care in handling them to ensure against electrostatic build-up.

1. To prevent electrostatic build-up, leave the system board in its anti-static bag until you are ready to install it.
2. Wear an antistatic wrist strap.
3. Do all preparation work on a static-free surface.
4. Hold the device only by its edges. Be careful not to touch any of the components, contacts or connections.
5. Avoid touching the pins or contacts on all modules and connectors. Hold modules or connectors by their ends.



Important:

Electrostatic discharge (ESD) can damage your processor, disk drive and other components. Perform the upgrade instruction procedures described at an ESD workstation only. If such a station is not available, you can provide some ESD protection by wearing an antistatic wrist strap and attaching it to a metal part of the system chassis. If a wrist strap is unavailable, establish and maintain contact with the system chassis throughout any procedures requiring ESD protection.

Safety Measures

To avoid damage to the system:

- Use the correct AC input voltage range.

To reduce the risk of electric shock:

- Unplug the power cord before removing the system chassis cover for installation or servicing. After installation or servicing, cover the system chassis before plugging the power cord.

Before Using the System Board

Before using the system board, prepare basic system components. If you are installing the system board in a new system, you will need at least the following internal components.

- Storage devices such as hard disk drive, etc.

You will also need external system peripherals you intend to use which will normally include at least a keyboard, a mouse and a video display monitor.

Chapter 1 - Introduction

Specifications

SYSTEM	Processor	6th Generation Intel® Core™ Processors, BGA 1356 (Skylake-U*) Intel® Core™ i7-6600U Processor, Dual Core, 4M Cache, 2.6GHz (3.4GHz), 15W Intel® Core™ i5-6300U Processor, Dual Core, 3M Cache, 2.4GHz (3.0GHz), 15W Intel® Core™ i3-6100U Processor, Dual Core, 3M Cache, 2.3GHz, 15W Intel® Core™ i7-7600U Processor, Dual Core, 4M Cache, 2.8GHz (3.9GHz), 15W
	Memory	DDR4-2400 SO-DIMM 260pin 8GB (1R*8) x 2pcs
	BIOS	Insyde SPI 128Mbit
GRAPHICS	Controller	Intel® HD Graphics GT Series
	Feature	OpenGL 5.0, DirectX 12, OpenCL 2.1 HW Decode: AVC/H.264, MPEG2, VC1/WMV9, JPEG/MJPEG, HEVC/H265, VP8, VP9 HW Encode: AVC/H.264, MPEG2, JPEG, HEVC/H265, VP8, VP9
	Display	1 x HDMI
EXPANSION	Interface	1 x Full-size Mini PCIe
	Storage	1 x Flash Module mSATA SATAIII 256GB MLC
ETHERNET	Controller	3 x Intel® I210IT PCIe (10/100/1000Mbps) 1 x Intel® I219LM PCIe with iAMT9.5 (10/100/1000Mbps) (only Core i7/i5 supports iAMT)
REAR I/O	Ethernet	4 x GbE (RJ-45)
	USB	4 x USB 3.0
FRONT I/O	USB	2 x USB 3.0
INTERNAL I/O	SATA	1 x SATA 3.0 (up to 6Gb/s) 1 x SATA Power
	SMBus	1 x SMBus
	Display	1 x HDMI
WATCHDOG TIMER	Output & Interval	System Reset, Programmable via Software from 1 to 255 Seconds
SECURITY	TPM	TPM 2.0
POWER	Type	Wide Range 15~36V
	Connector	Terminal Block
	Consumption	TBD
	RTC Battery	CR2032 Coin Cell

OS SUPPORT	Microsoft/ Linux	Windows 7 (32/64-bit) Windows 8.1 (64-bit) Windows 10 WES 7 WE8S CentOS 7 (1804)
	ENVIRONMENT	Temperature Operating: -20 to 70°C Storage: -40 to 85°C
MECHANICAL	Humidity	TBD
	MTBF	TBD
	Dimensions	4" SBC Form Factor 165mm (6.49") x 135mm (5.31")
	Height	PCB: 1.6mm Top Side: TBD, Bottom Side: TBD

Features

• Watchdog Timer

The Watchdog Timer function allows your application to regularly “clear” the system at the set time interval. If the system hangs or fails to function, it will reset at the set time interval so that your system will continue to operate.

• DDR4

DDR4 deliver increased system bandwidth and improved performance at a lower power than DDR3 and DDR3L. It is not compatible with older standards of DDR memories.

• Graphics

The integrated Intel® HD graphics engine delivers an excellent blend of graphics performance and features to meet business needs. It provides excellent video and 3D graphics with outstanding graphics responsiveness. These enhancements deliver the performance and compatibility needed for today’s and tomorrow’s business applications. Supports 1 HDMI interface for display output.

• Serial ATA

Serial ATA is a storage interface that is compliant with SATA 1.0a specification. With speed of up to 6Gb/s (SATA 3.0), it improves hard drive performance faster than the standard parallel ATA whose data transfer rate is 100MB/s.

• Gigabit LAN

Four Intel® Gigabit LAN controllers (three Intel® I210IT PCI Express Gigabit Ethernet controllers and one Intel® I219LM Gigabit Ethernet Phy) support up to 1Gbps data transmission.

• Power Failure Recovery

When power returns after an AC power failure, you may choose to either power-on the system manually or let the system power-on automatically.

• USB

The system board supports the USB 3.0. It is capable of running at a maximum transmission speed of up to 5 Gbit/s (625 MB/s) and is faster than USB 2.0 (480 Mbit/s, or 60 MB/s) and USB 1.1 (12Mb/s). USB 3.0 reduces the time required for data transmission, reduces power consumption, and is backward compatible with USB 2.0. It is a marked improvement in device transfer speeds between your computer and a wide range of simultaneously accessible external Plug and Play peripherals.

• Wake-On-LAN

This feature allows the network to remotely wake up a Soft Power Down (Soft-Off) PC. It is supported via the onboard LAN port or via a PCI LAN card that uses the PCI PME (Power Management Event) signal. However, if your system is in the Suspend mode, you can power-on the system only through an IRQ or DMA interrupt.

• Wake-On-USB

This function allows you to use a USB keyboard or USB mouse to wake up a system from the S3 (STR - Suspend To RAM) state.

• ACPI STR

The system board is designed to meet the ACPI (Advanced Configuration and Power Interface) specification. ACPI has energy saving features that enables PCs to implement Power Management and Plug-and-Play with operating systems that support OS Direct Power Management. ACPI when enabled in the Power Management Setup will allow you to use the Suspend to RAM function.

With the Suspend to RAM function enabled, you can power-off the system at once by pressing the power button or selecting “Standby” when you shut down Windows® without having to go through the sometimes tiresome process of closing files, applications and operating system. This is because the system is capable of storing all programs and data files during the entire operating session into RAM (Random Access Memory) when it powers-off. The operating session will resume exactly where you left off the next time you power-on the system.

Chapter 2 - Hardware Installation

Board Layout

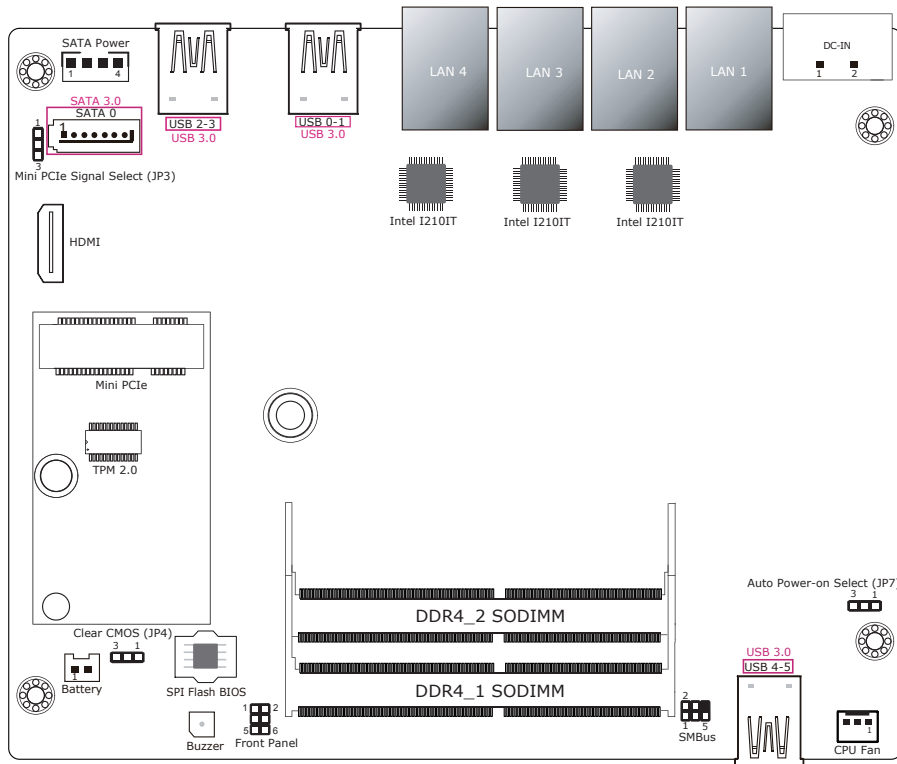

Top View

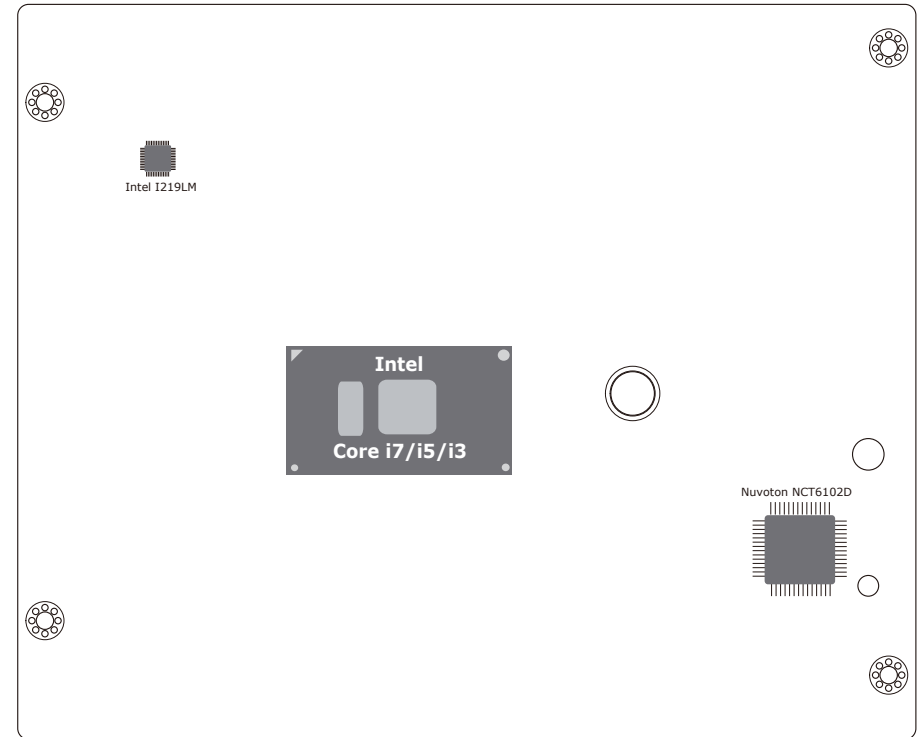

Bottom View

Block Diagram

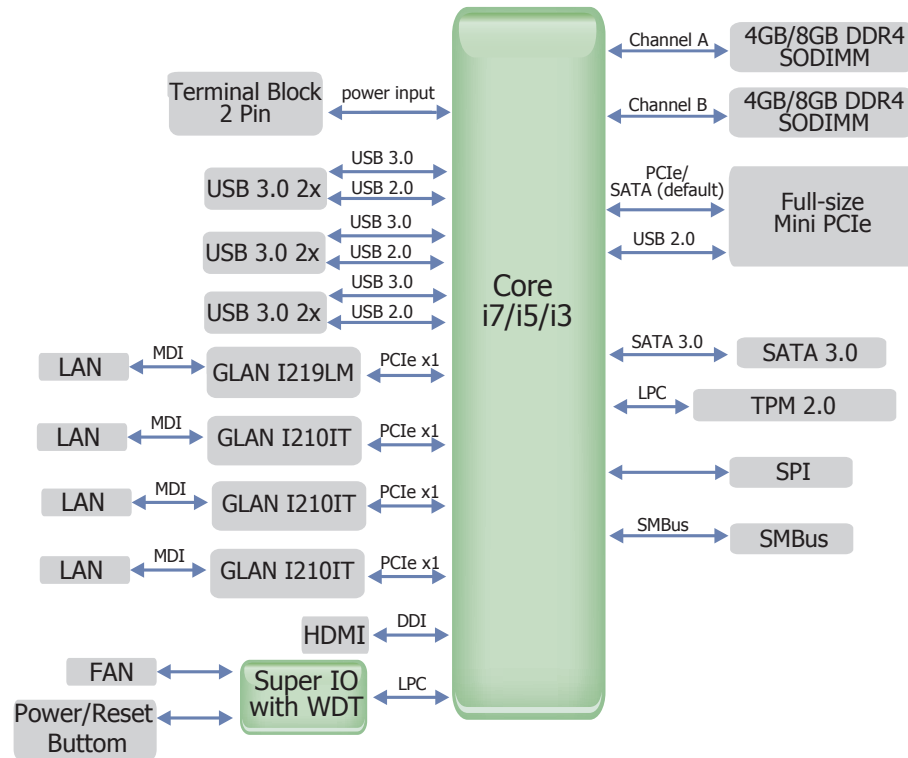

Mechanical Diagram

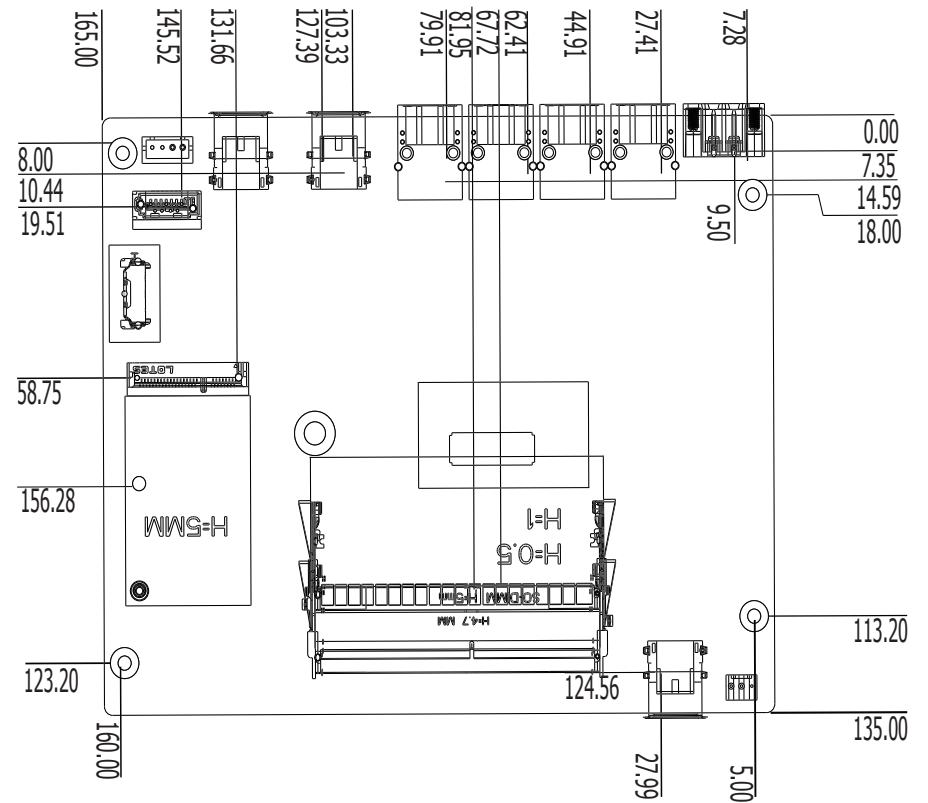

**Important:**

Electrostatic discharge (ESD) can damage your board, processor, disk drives, add-in boards, and other components. Perform installation procedures at an ESD workstation only. If such a station is not available, you can provide some ESD protection by wearing an antistatic wrist strap and attaching it to a metal part of the system chassis. If a wrist strap is unavailable, establish and maintain contact with the system chassis throughout any procedures requiring ESD protection.

System Memory

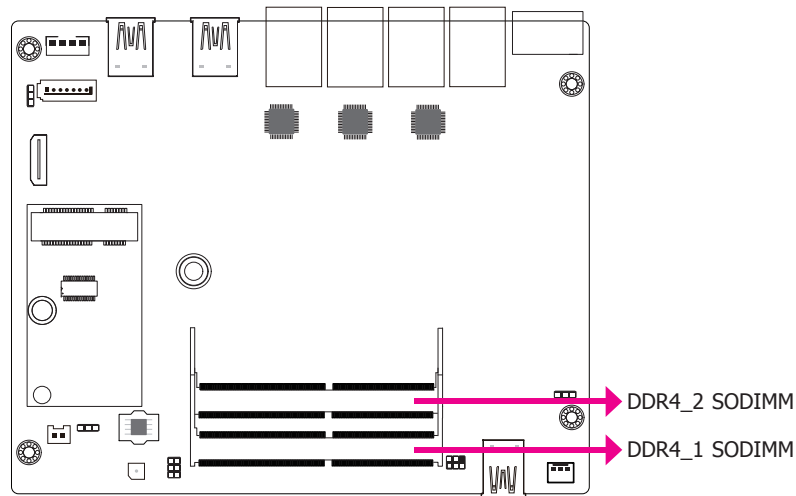

Features

- Two 260-pin SODIMM up to 8GB
- Dual Channel DDR4 2400MHz

Jumper Settings

Clear CMOS

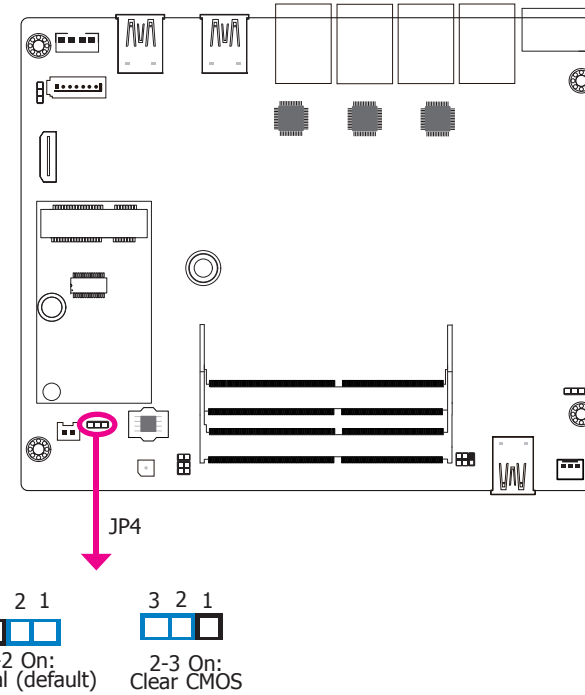

If you encounter the following,

- CMOS data becomes corrupted.
- You forgot the supervisor or user password.

you can reconfigure the system with the default values stored in the ROM BIOS.

To load the default values stored in the ROM BIOS, please follow the steps below.

1. Power-off the system and unplug the power cord.
2. Set JP4 pins 2 and 3 to On. Wait for a few seconds and set JP4 back to its default setting, pins 1 and 2 On.
3. Now plug the power cord and power-on the system.

Auto Power-on Select

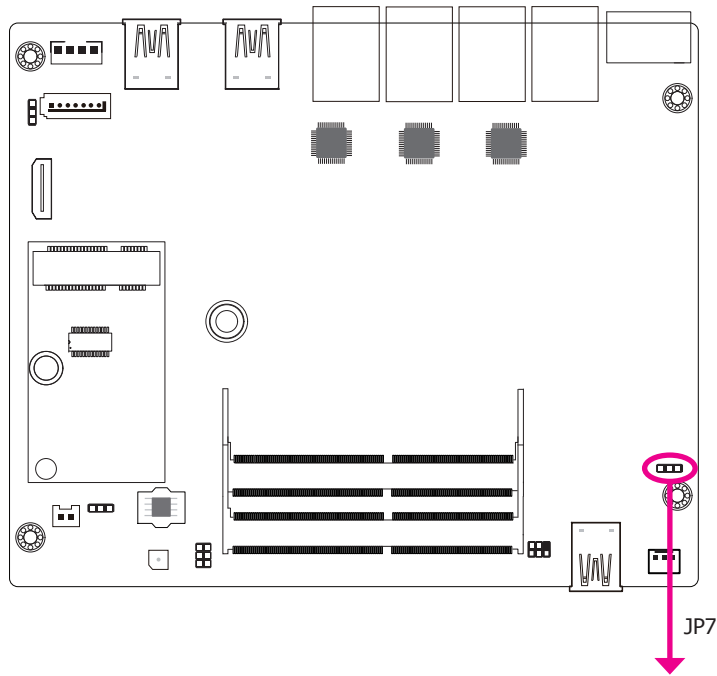

1-2 On:
Power-on via power button
(default)



2-3 On:
Power-on via AC power

JP7 is used to select the method of powering on the system. If you want the system to power-on whenever AC power comes in, set JP7 pins 2 and 3 to On. If you want to use the power button, set pins 1 and 2 to On.

When using the JP7 "Power On" feature to power the system back on after a power failure occurs, the system may not power on if the power lost is resumed within 5 seconds (power flicker).

Mini PCIe Signal Select

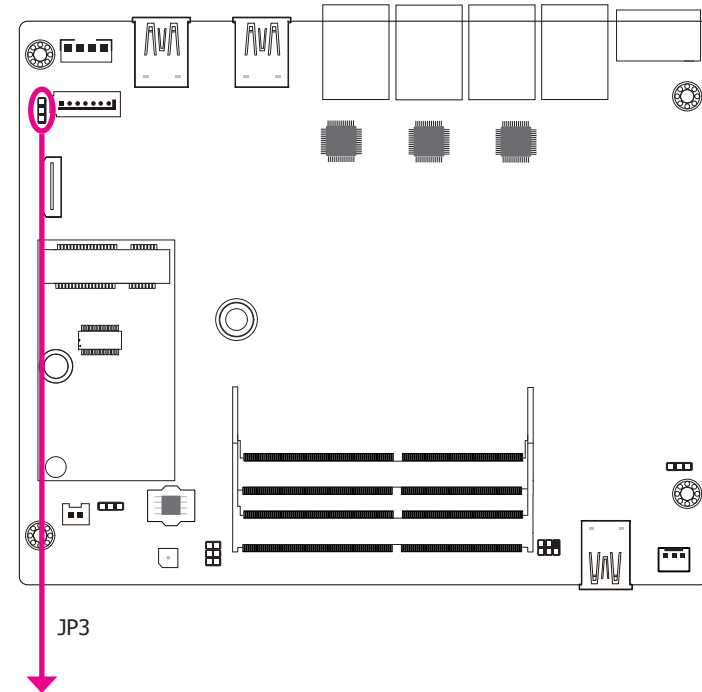

1-2 On:
mSATA (default)



2-3 On:
PCIe

JP3 is used to select the Mini PCIe signal: PCIe or mSATA (default).

Front Panel I/O Ports

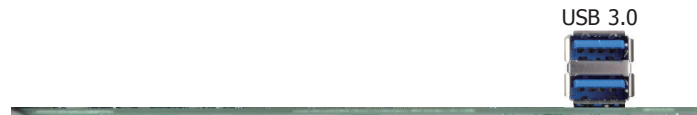

The front panel I/O ports consist of the following:

- 2 USB 3.0 ports

Rear Panel I/O Ports



The rear panel I/O ports consist of the following:

- 1 15~36V DC-in 2-pin terminal block
- 4 LAN ports
- 4 USB 3.0 ports

15~36V DC-in

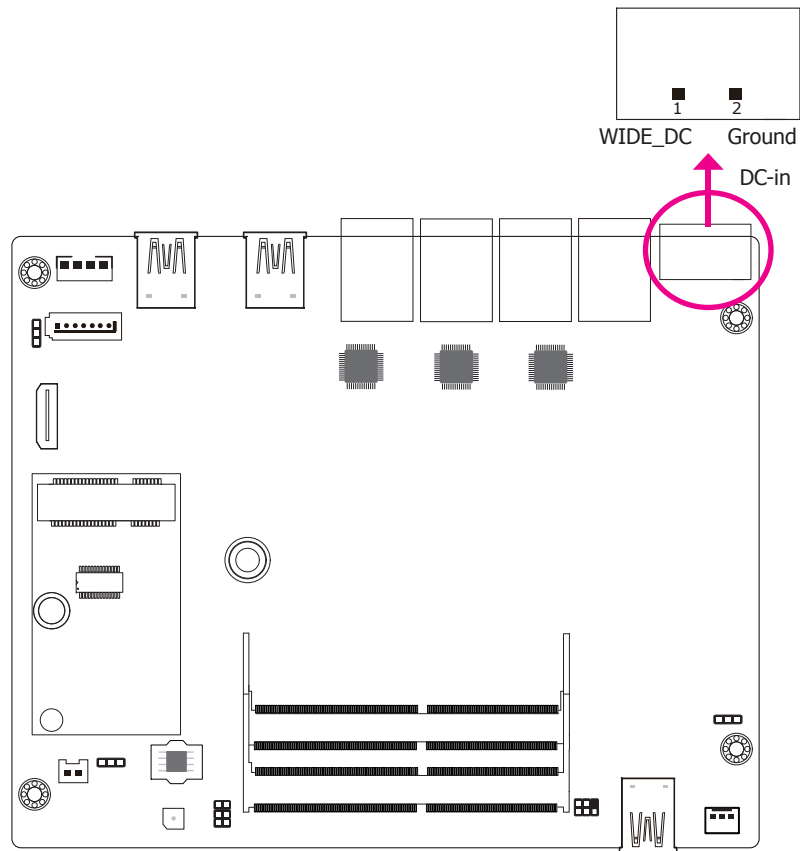

Connect a DC power cord to the 2-pin terminal block. Using a voltage more than the recommended range may fail to boot the system or cause damage to the system board.

Graphics Interface

The display port consists of the following:

- 1 HDMI port

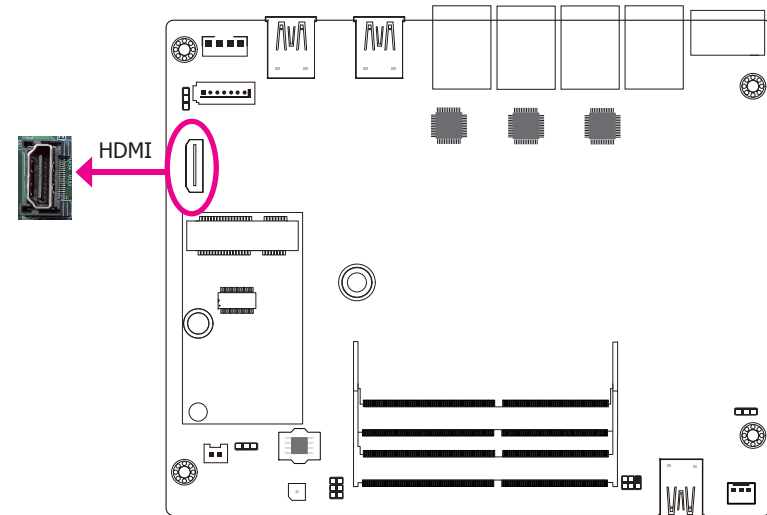

HDMI Port

The HDMI port which carries both digital audio and video signals is used to connect a LCD monitor or digital TV that has the HDMI port.

USB Ports

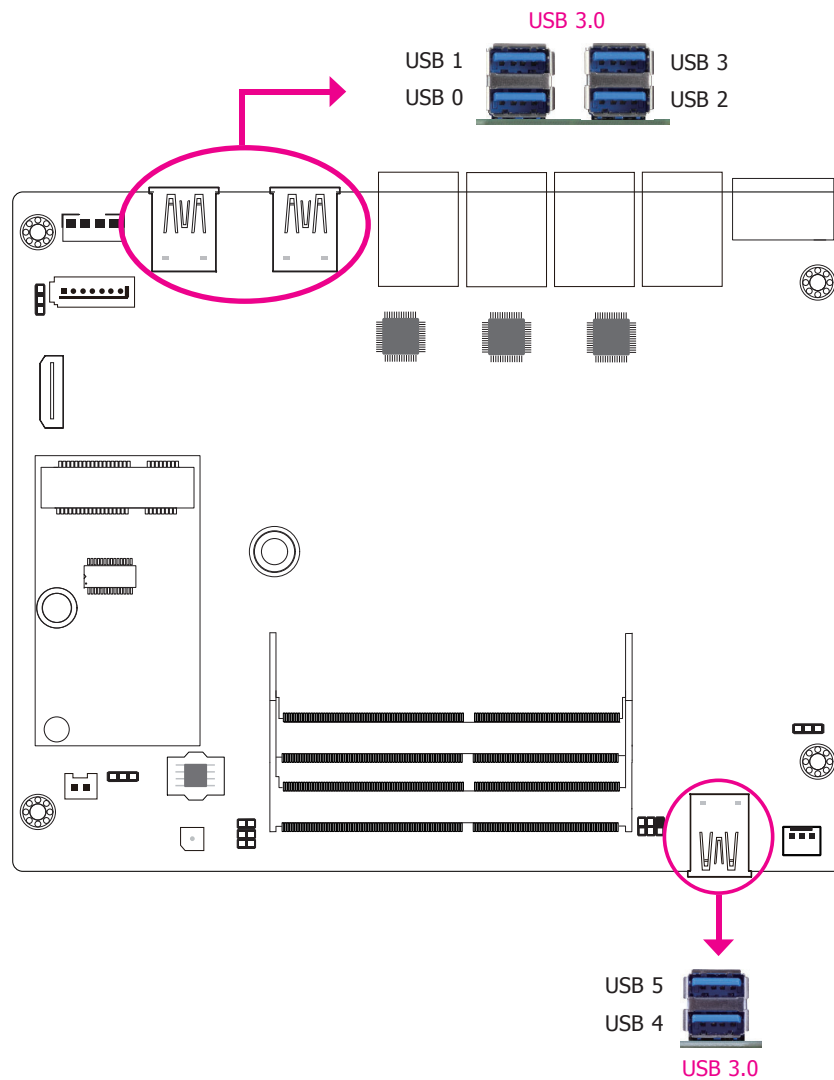

The USB device allows data exchange between your computer and a wide range of simultaneously accessible external Plug and Play peripherals.

The system board is equipped with 6 onboard USB 3.0 port (USB 0-1/2-3/4-5).

BIOS Setting

Configure the onboard USB in the Advanced menu ("USB Configuration" submenu) of the BIOS. Refer to chapter 3 for more information.

Driver Installation

You may need to install the proper drivers in your operating system to use the USB device. Refer to chapter 4 for more information.

Wake-On-USB Keyboard/Mouse

The Wake-On-USB Keyboard/Mouse function allows you to use a USB keyboard or USB mouse to wake up a system from the S3 (STR - Suspend To RAM) state.

RJ45 LAN Ports

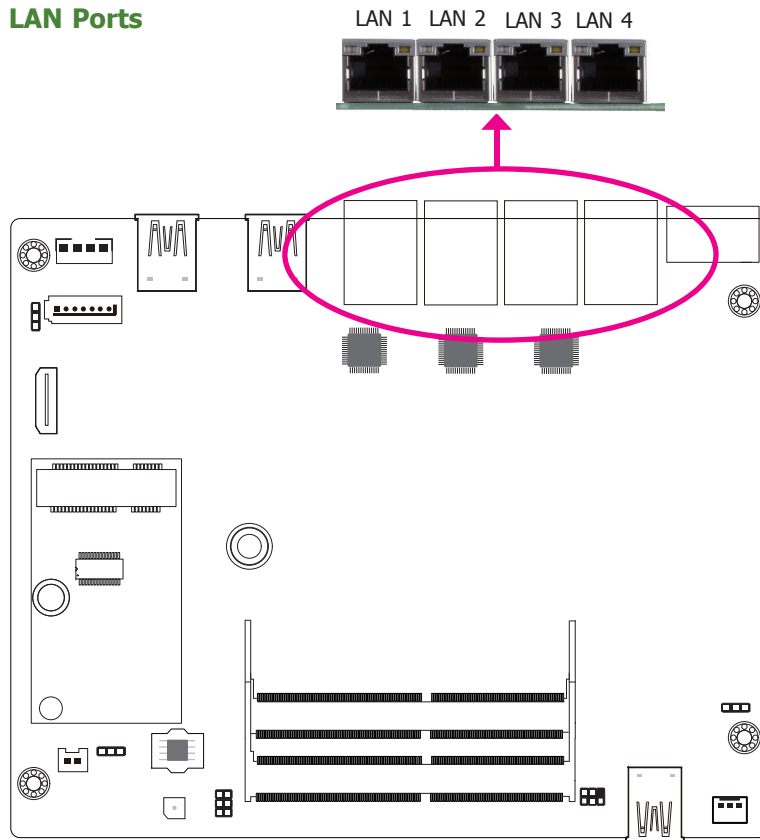

Features

- 3 Intel® I210IT PCI Express Gigabit Ethernet controllers
- 1 Intel® I219LM PCI Express Gigabit Ethernet controller

The LAN ports allow the system board to connect to a local area network by means of a network hub.

Driver Installation

Install the LAN drivers. Refer to chapter 4 for more information.

I/O Connectors

Serial ATA Connector

Serial ATA Power Connector

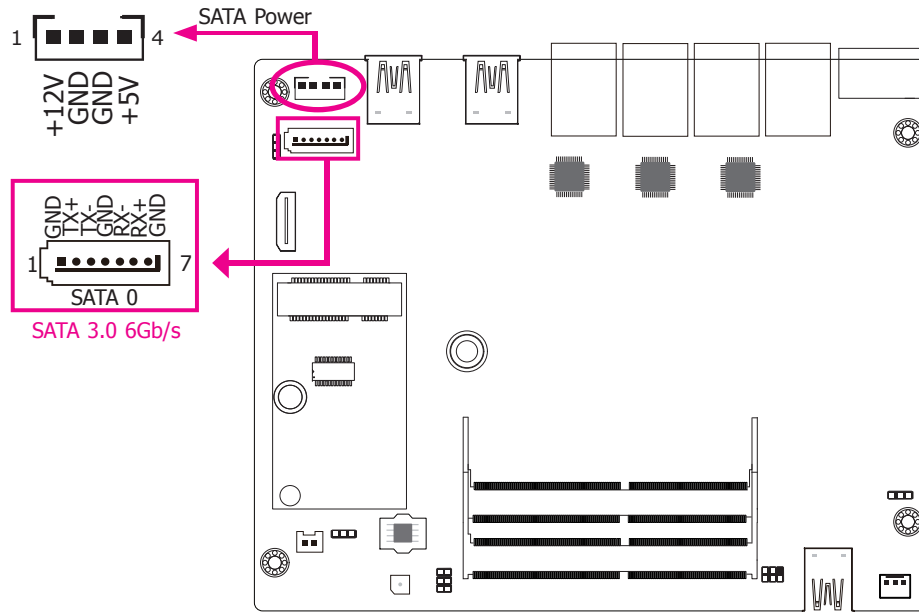

Features

- 1 Serial ATA 3.0 port with data transfer rate up to 6Gb/s
- Integrated Advanced Host Controller Interface (AHCI) controller

The Serial ATA connector is used to connect the Serial ATA device. Connect one end of the Serial ATA data cable to a SATA connector and the other end to your Serial ATA device.

The SATA power connector supplies power to the SATA drive. Connect one end of the provided power cable to the SATA power connector and the other end to your storage device.

BIOS Setting

Configure the Serial ATA drives in the Advanced menu ("SATA Configuration" submenu) of the BIOS. Refer to chapter 3 for more information.

Expansion Slot

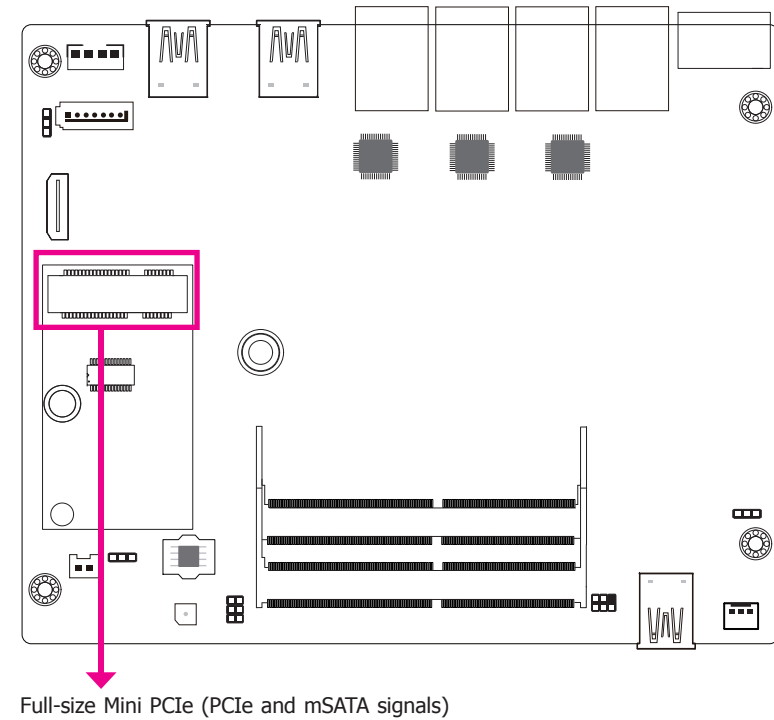

Mini PCI Express Slot

The full-size Mini PCIe socket supports the installation of a Mini PCIe card or an mSATA card (flash module mSATA SATAIII 256GB MLC) .

To switch between these two signals, use JP3. Refer to the previous section for more information.

Cooling Fan Connector

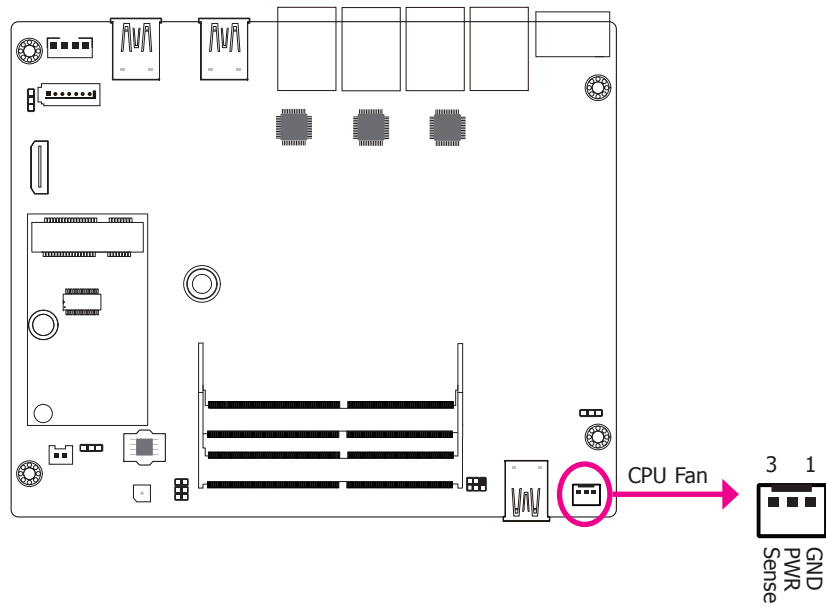

The fan connector is used to connect the cooling fan. The cooling fan will provide adequate airflow throughout the chassis to prevent overheating the CPU and system board components.

BIOS Setting

The Advanced menu ("SIO NUVOTON6102D" submenu) of the BIOS will display the current speed of the cooling fans. Refer to chapter 3 for more information.

SMBus Connector

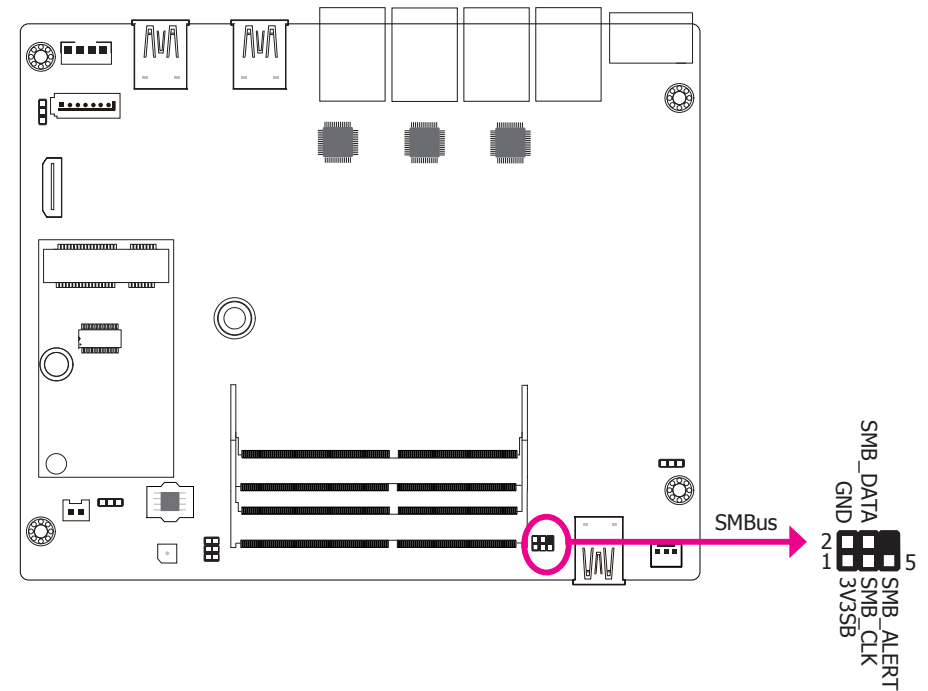

The SMBus (System Management Bus) connector is used to connect SMBus devices. It is a multiple device bus that allows multiple chips to connect to the same bus and enable each one to act as a master by initiating data transfer.

Front Panel Connector

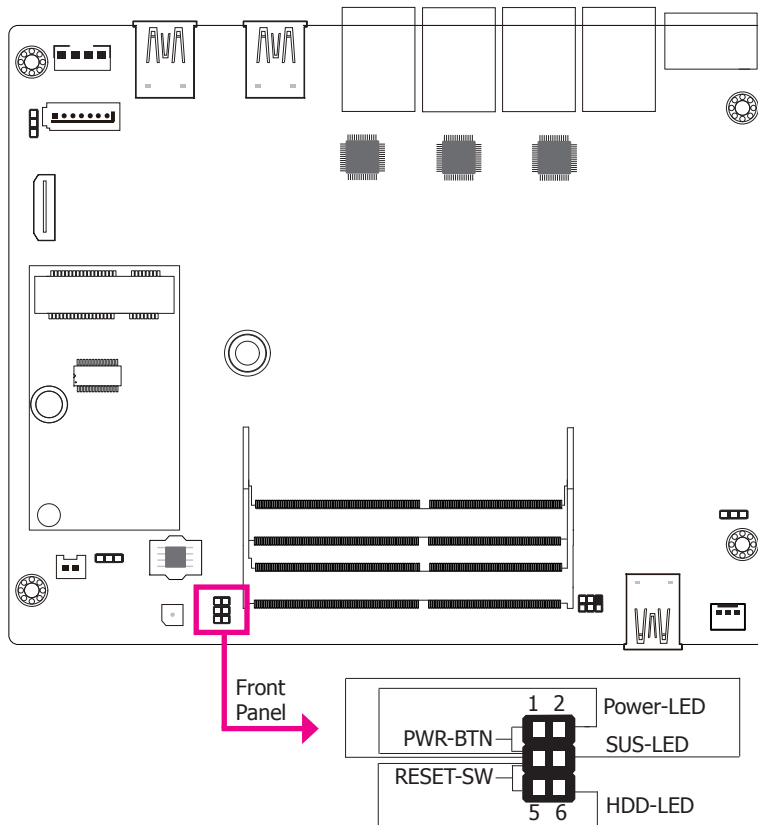

HDD-LED - HDD LED

This LED will be lit when the hard drive is being accessed.

RESET-SW - Reset Switch

This switch allows you to reboot without having to power off the system.

PWR-BTN - Power Switch

This switch is used to power on or off the system.

PWR-LED - Power LED

When the system's power is on, this LED will be lit.

SUS-LED - Suspend Mode LED

When the system is in the S1 (POS - Power On Suspend) state, it will blink every second. When the system is in the S3 (STR - Suspend To RAM) state, it will blink every 4 seconds.

	Pin	Pin Assignment		Pin	Pin Assignment
HDD-LED	3	GND	PWR-BTN	1	Power Button
	6	HD LED		3	GND
RESET-SW	3	GND	PWR-LED	2	Power LED
	5	Signal		3	GND
			SUS-LED	3	GND
				4	SUS LED

Battery

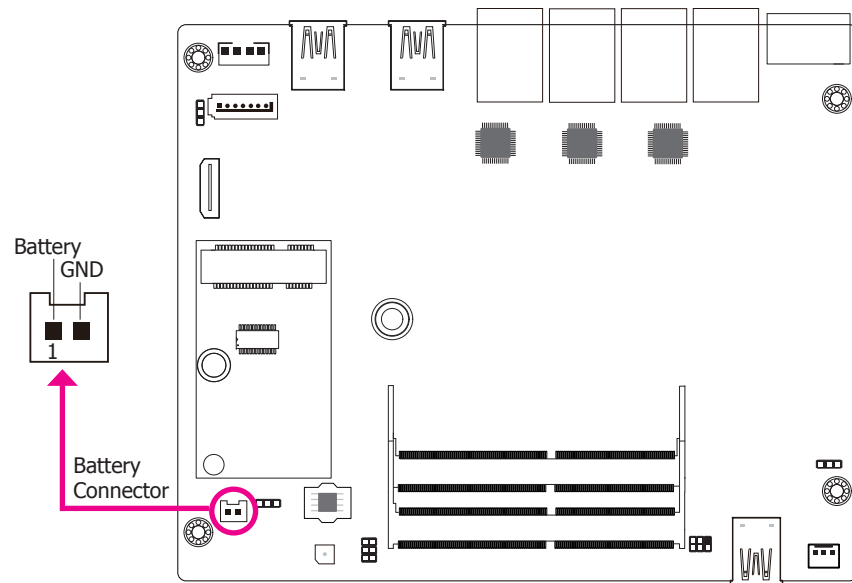

Connect to the battery connector

The lithium ion battery powers the real-time clock and CMOS memory. It is an auxiliary source of power when the main power is shut off.

Safety Measures

- Danger of explosion if battery incorrectly replaced.
- Replace only with the same or equivalent type recommended by the manufacturer.
- Dispose of used batteries according to local ordinance.

Chapter 3 - BIOS Setup

Overview

The BIOS is a program that takes care of the basic level of communication between the CPU and peripherals. It contains codes for various advanced features found in this system board. The BIOS allows you to configure the system and save the configuration in a battery-backed CMOS so that the data retains even when the power is off. In general, the information stored in the CMOS RAM of the EEPROM will stay unchanged unless a configuration change has been made such as a hard drive replaced or a device added.

It is possible that the CMOS battery will fail causing CMOS data loss. If this happens, you need to install a new CMOS battery and reconfigure the BIOS settings.



Note:

The BIOS is constantly updated to improve the performance of the system board; therefore the BIOS screens in this chapter may not appear the same as the actual one. These screens are for reference purpose only.

Default Configuration

Most of the configuration settings are either predefined according to the Load Optimal Defaults settings which are stored in the BIOS or are automatically detected and configured without requiring any actions. There are a few settings that you may need to change depending on your system configuration.

Entering the BIOS Setup Utility

The BIOS Setup Utility can only be operated from the keyboard and all commands are keyboard commands. The commands are available at the right side of each setup screen.

The BIOS Setup Utility does not require an operating system to run. After you power up the system, the BIOS message appears on the screen and the memory count begins. After the memory test, the message "Press DEL to run setup" will appear on the screen. If the message disappears before you respond, restart the system or press the "Reset" button. You may also restart the system by pressing the <Ctrl> <Alt> and keys simultaneously.

Legends

Keys	Function
Right and Left arrows	Moves the highlight left or right to select a menu.
Up and Down arrows	Moves the highlight up or down between submenu or fields.
<Esc>	Exit to the BIOS Setup Utility.
<F5>	Scrolls forward through the values or options of the highlighted field.
<F6>	Scrolls backward through the values or options of the highlighted field.
Tab	Select a field.
<F1>	Displays general help
<F9>	Optimized defaults
<F10>	Saves and resets the setup program.
<Enter>	Press <Enter> to enter the highlighted submenu.

Scroll Bar

When a scroll bar appears to the right of the setup screen, it indicates that there are more available fields not shown on the screen. Use the up and down arrow keys to scroll through all the available fields.

Submenu

When "►" appears on the left of a particular field, it indicates that a submenu which contains additional options are available for that field. To display the submenu, move the highlight to that field and press <Enter>.

Insyde BIOS Setup Utility

Main

The Main menu is the first screen that you will see when you enter the BIOS Setup Utility.

InsydeH2O Setup Utility		Rev. 5.0
Main	Advanced	Security Boot Exit
Project Name	SU256	This is the help for the hour, minute, second field. Valid range is from 0 to 23, 0 to 59, 0 to 59. INCREASE/REDUCE: +/-.
BIOS Version	B194.12A	
Supported Processor	Intel 6th and 7th Generation CPU	
Processor Type	Intel(R) Core(TM) i7-7600U CPU @ 2.80GHz	
CPUID:	0x806E9 (KABYLAKE ULT ULX)	
CPU Speed:	2900 MHz	
CPU Stepping:	09 (KBL H0/J0 Stepping)	
L1 Data Cache:	32 KB	
L1 Instruction Cache:	32 KB	
L2 Cache:	256 KB	
L3 Cache:	4096 KB	
Number Of Processors:	2 Core(s) / 4 Thread(s)	
Microcode Rev:	0000008E	
Total Memory	16384 MB	
System Memory Speed	2133 MHz	
SODIMM 0	8192 MB	
SODIMM 1	8192 MB	
PCH Rev / SKU	21 (C1 Stepping) / SKL PCH-LP (U) iHDCP	
Intel ME Version / SKU	2.2 Premium 11.8.55.3510 / CORPORATE	
System Time	[13:29:03]	
System Date	[08/05/2019]	

F1 Help ↑/↓ Select Item F5/F6 Change Values F9 Setup Defaults
Esc Exit ←/→ Select Item Enter Select ► SubMenu F10 Save and Exit

System Time

The time format is <hour>, <minute>, <second>. The time is based on the 24-hour military-time clock. For example, 1 p.m. is 13:00:00. Hour displays hours from 00 to 23. Minute displays minutes from 00 to 59. Second displays seconds from 00 to 59.

System Date

The date format is <month>, <date>, <year>. Month displays the month, from 01 to 12. Date displays the date, from 01 to 31. Year displays the year, from 2000 to 2099.

Advanced

The Advanced menu allows you to configure your system for basic operation. Some entries are defaults required by the system board, while others, if enabled, will improve the performance of your system or let you set some features according to your preference.



Important:

Setting incorrect field values may cause the system to malfunction.

InsydeH2O Setup Utility		Rev. 5.0
Main	Advanced	Security Boot Exit
▶ACPI Configuration		ACPI Configuration Setting
▶CPU Configuration		
▶Video Configuration		
▶Audio Configuration		
▶SATA Configuration		
▶USB Configuration		
▶PCI Express Configuration		
▶ME Configuration		
▶Active Management Technology Support		
▶MEBX Configuration		
▶UEFI Device Manager		
▶SIO NUVOTON6102D		

F1 Help ↑/↓ Select Item F5/F6 Change Values F9 Setup Defaults
Esc Exit ←/→ Select Item Enter Select ► SubMenu F10 Save and Exit

ACPI Configuration

This section is used to configure the system ACPI parameters.

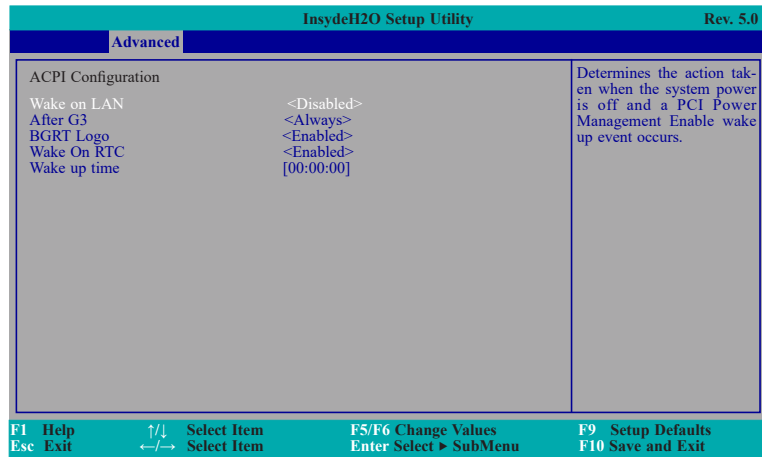

Wake on RTC

Wake On Real-time clock (RTC) allows the system to wake up from S4 or S5 states at the configured time. When enabled, please also set up the Wake Up Time that follows this field.

Wake up time

When Wake on RTC is enabled, this field will appear. Please configure the time (i.e. hour, minute, and second) at which the system is specified to wake up.

Wake on LAN

This field is used to enable or disable the LAN signal to wake up the system.

After G3

This field is to specify what state to go when power is re-applied after a power failure (G3 state).

S0 State The system working state.

S5 State System off, except for trickle current to devices such as the power button.

BGRT Logo

This field use to enable or disable to support display logo with ACPI BGRT table.



Note:

BGRT Logo field will appear only when Quiet Boot is enabled. Refer to the Boot menu later in this chapter for more information.

CPU Configuration

This section is used to configure the CPU.

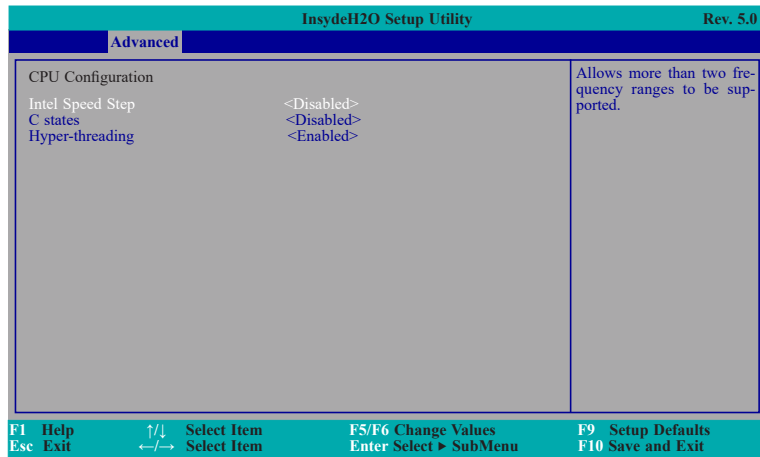

Intel(R) SpeedStep(tm)

This field is used to enable or disable the Intel Enhanced SpeedStep Technology.

Turbo Mode

Enable or disable the turbo mode.

C states

Enable or disable C-states. By enabling it, clock and voltage will be reduced when the system load is low.

Hyper-threading

Enable or disable Hyper-threading. When it is enabled, a physical core will perform as two logical processors, and the user may experience better computational efficiency of the system.

Video Configuration

This section configures the video settings.

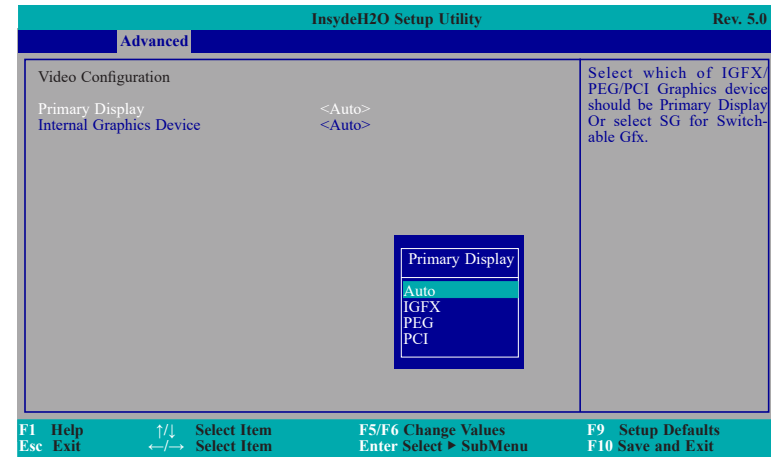

Primary Display

Set the initial priority.

Internal Graphics

Keep IGFX enabled or disabled based on the setup options.

Audio Configuration

This section is used to configure the audio settings.

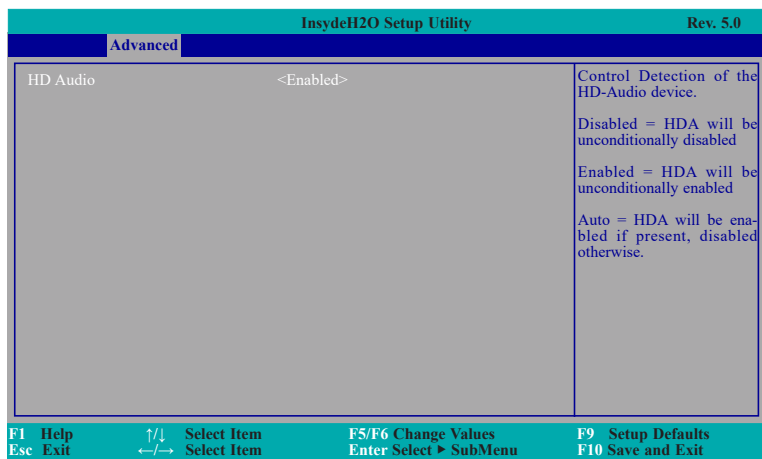

HD Audio

Control the detection of the HD audio device.

Disabled

HDA will be unconditionally disabled.

Enabled

HDA will be unconditionally enabled.

Auto

HDA will be enabled if present, disabled otherwise.

SATA Configuration

This section is designed to select the SATA controller and the type of hard disk drive which are installed in your system unit.

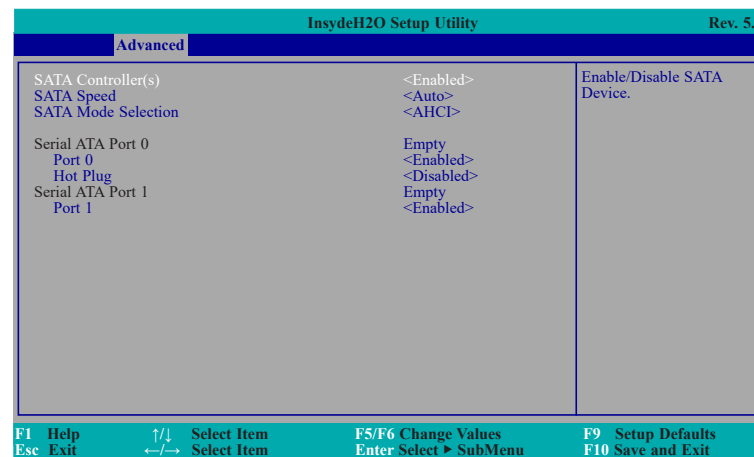

SATA Controller(s)

This field is used to enable or disable Serial ATA devices.

SATA Speed

Select the SATA speed (generation): Auto, Gen1, Gen2, or Gen3.

SATA Mode Selection

The mode selection determines how the SATA controller(s) operates.

AHCI

This option allows the Serial ATA devices to use AHCI (Advanced Host Controller Interface).

RAID

This option allows you to create RAID or Intel Rapid Storage configuration on Serial ATA devices.

Port 0/1

Enable or disable the serial ATA port.

Hot Plug

Enable or disable hot plug of the SATA port 0 (SATA 3.0).

USB Configuration

This section is used to configure the parameters of the USB device.

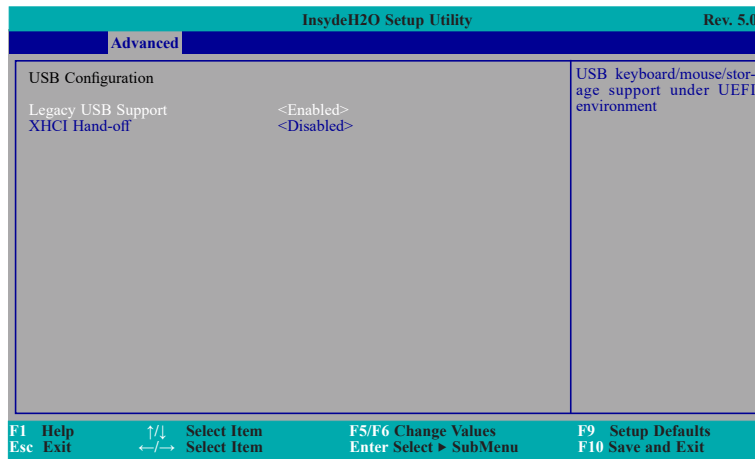

Legacy USB Support

Disabled

Disable USB keyboard/mouse/storage support under UEFI and DOS environment.

Enabled

Enable USB keyboard/mouse/storage support under UEFI and DOS environment.

UEFI Only

Enable USB keyboard/mouse/storage support under UEFI environment.

PCI Express Configuration

This section configures settings relevant to PCI Express root ports. Press Enter to configure each port.

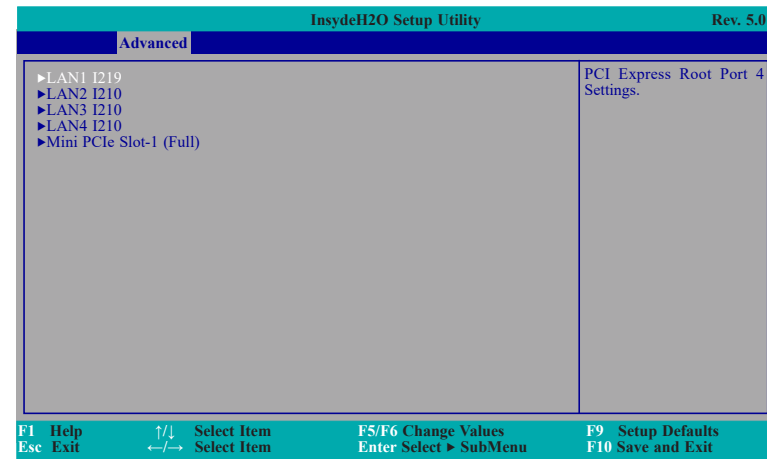

PCI Express Root Port 4/5/6

This field is used to enable or disable the PCI Express Root Port.

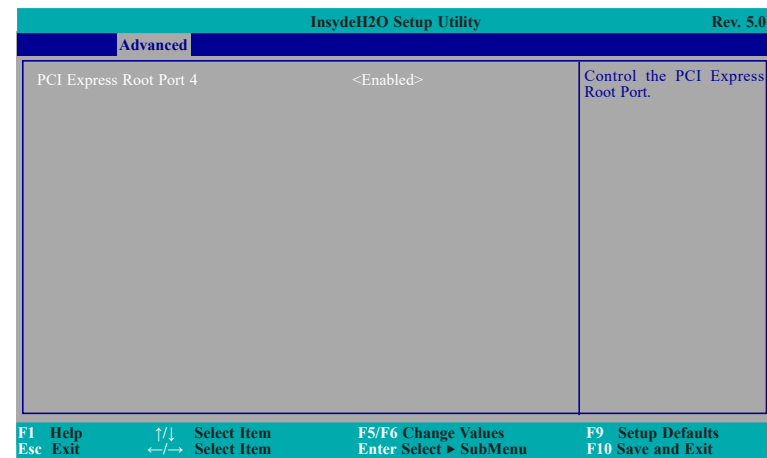

ME Configuration

This section configures settings relevant to flash ME region.

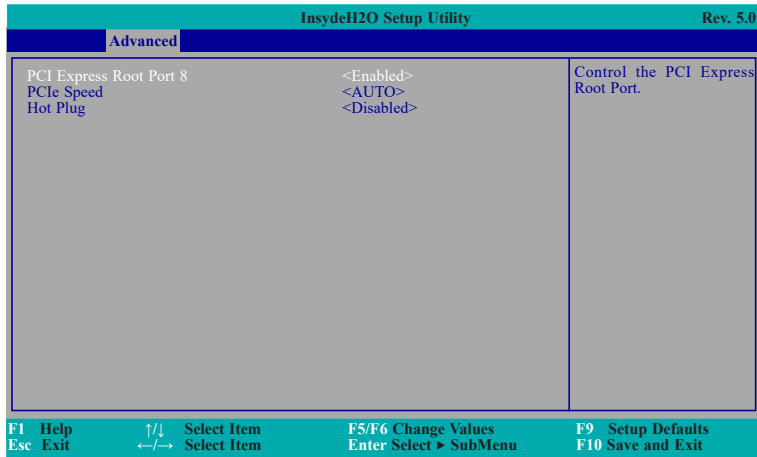

PCI Express Root Port 8

This field is used to enable or disable the PCI Express Root Port for the Mini PCIe Slot-1 that can also be configured as mSATA.

PCIe Speed

Select the speed of the PCI Express Root Port: Auto, Gen1, Gen2 or Gen3.

Hot Plug

This field is used to enable or disable hot plug of the Mini PCIe port.

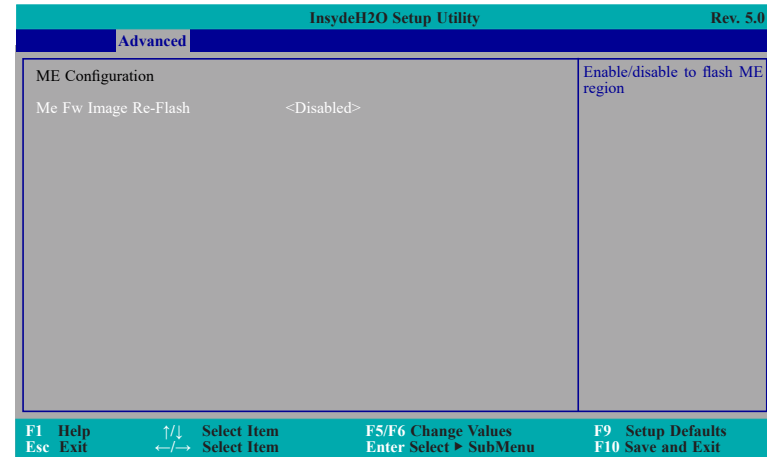

Me Fw Image Re-Flash

This field is used to enable or disable the flash ME region.

Active Management Technology Support

The section allows users to enable or disable the Intel® Active Management Technology (Intel® AMT). Please refer to **Chapter 6** for more information.

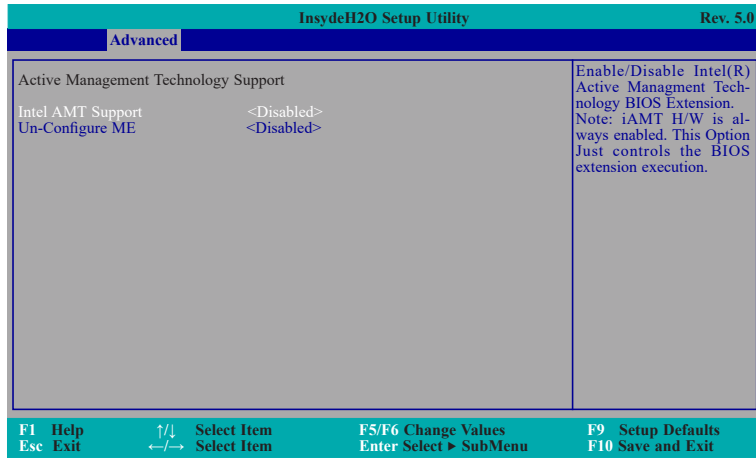

Intel AMT Support

This field is used to enable or disable Intel® Active Management Technology.

Un-Configure ME

This field is used to enable or disable to un-configure ME with resetting MEBX password to default.

MEBX Configuration

Configure Intel® Active Management Technology (Intel® AMT) in the Intel® Management Engine BIOS Extension (MEBX) section. Please refer to **Chapter 6** for more information.

UEFI Device Manager

Press Enter and a prompt will show up. Press Enter again to exit BIOS and enter the setup page of Device Manager. To return to BIOS, please Esc to restart the system.

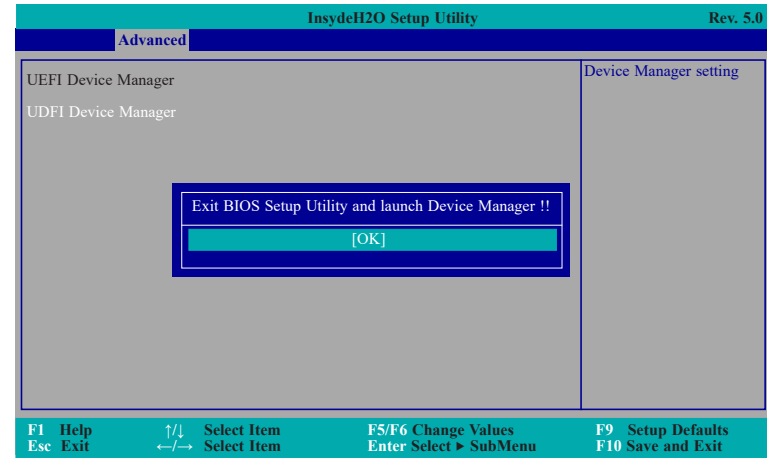

SIO NUVOTON6102D

This section configures the system super I/O chip parameters.

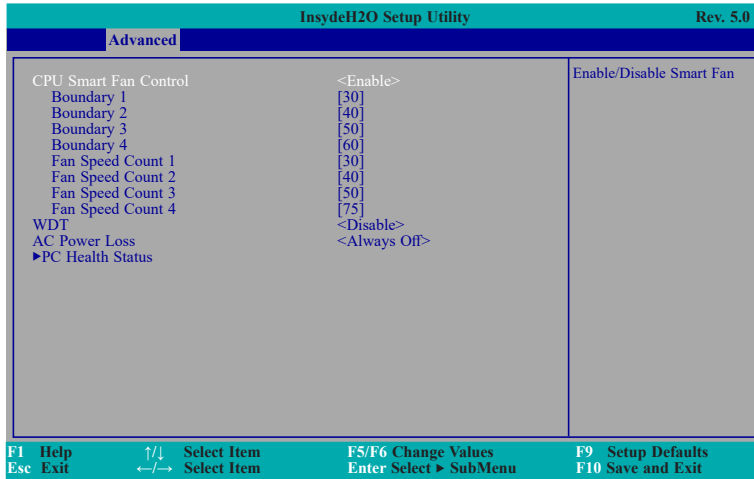

CPU Smart Fan Control

Enable or disable the CPU smart fan. When disabled, Fix Fan Speed Count field will appear for configuration.

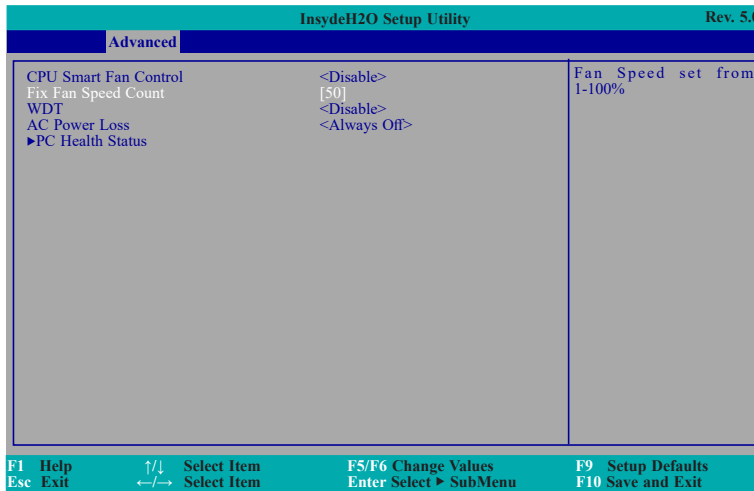

Fix Fan Speed Count

Set the fix fan speed. The range is from 1-100% (full speed).

Boundary 1 to Boundary 4

Set the boundary temperatures that determine the operation of the fan with different fan speeds accordingly. For example, when the system or the CPU temperature reaches boundary temperature 1, the system or CPU fan should be turned on and operate at the designated speed. The range is from 0-127°C.

Fan Speed Count 1 to Fan Speed Count 4

Set the fan speed. The range is from 1-100% (full speed).

WDT

Enable or disable the watchdog function. A counter will appear if you select to enable WDT. Input any value between 1 to 255 seconds.

AC Power Loss

Set the AC power loss to always off or always on.

PC Health Status

This section displays the PC health status.

Advanced		InsydeH2O Setup Utility		Rev. 5.0
PC Health Status				
Voltage				
VCORE	0.864	V		
5V	5.017	V		
+12V	11.968	V		
VDDQ	1.200	V		
VBAT	3.168	V		
3VSB	3.344	V		
Temperature				
System (°C/°F)	38.5 C/	101.3 F		
CPU (°C/°F)	45.5 C/	113.9 F		
Fan Speed				
CPU FAN	0	RPM		

F1 Help ↑/↓ Select Item **F5/F6** Change Values **F9** Setup Defaults
Esc Exit ←/→ Select Item Enter Select ► SubMenu **F10** Save and Exit

Security

Main		Advanced	Security	Boot	Exit	Rev. 5.0
Current TPM Device		<TPM 2.0 (DTPM)>		When Hidden, don't ex-		
TPM State		All Hierarchies Enabled, Owned		poses TPM to 0		
TPM Availability		<Available>				
TPM Operation		<No Operation>				
Supervisor Password		Not installed				
Set Supervisor Password						
Power on Password		<Disabled>				

F1 Help ↑/↓ Select Item **F5/F6** Change Values **F9** Setup Defaults
Esc Exit ←/→ Select Item Enter Select ► SubMenu **F10** Save and Exit

TPM Availability

Show or hide the TPM availability and its configurations.

TPM Operation

Enable or disable the TPM function. It displays the following options:

No Operation No changes to current state.

Enable Enable and activate TPM.

Set Supervisor Password

Set the supervisor's password and the length of the password must be greater than one character.

Power on Password

Disable Input of password is required when accessing the BIOS Setup Utility.

Enable Input of password is required during Power-on Self-test (POST).

Boot

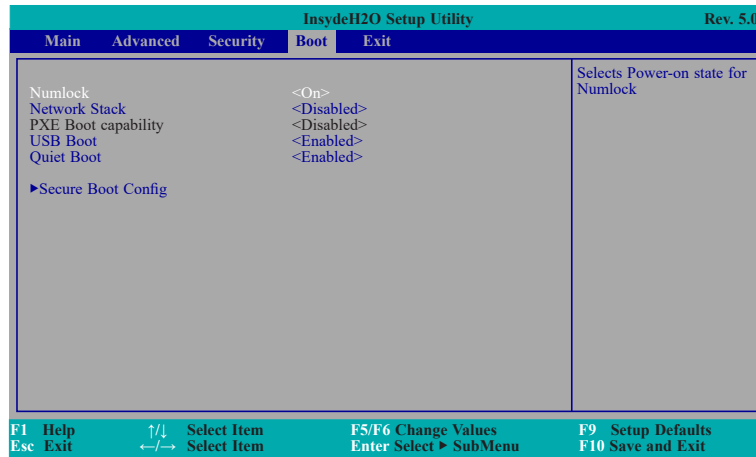

Numlock

Select the power-on state for numlock.

Network Stack

This field is used to enable or disable network stack.

PXE Boot capability

Disabled Support Network Stack

UEFI IPv4

UEFI IPv6

UEFI IPv4/IPv6

USB Boot

Enable or disable to change USB boot devices boot order.

Quiet Boot

Enable or disable Quiet Boot.

Secure Boot Config

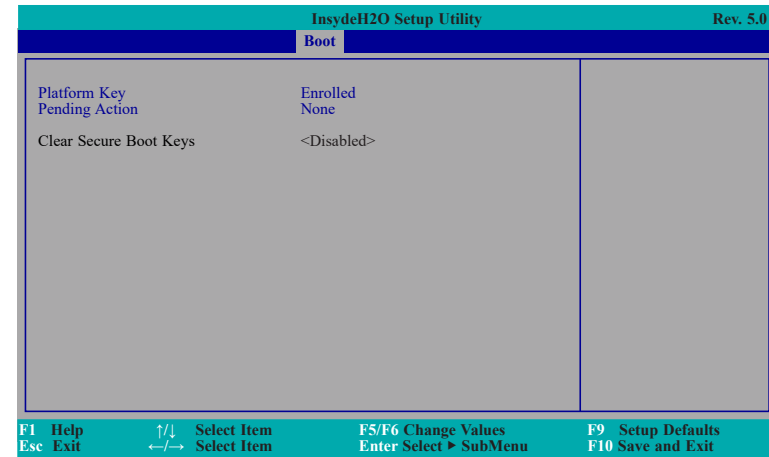

The secure key is enrolled as default and cannot be cleared for security reasons.

Exit

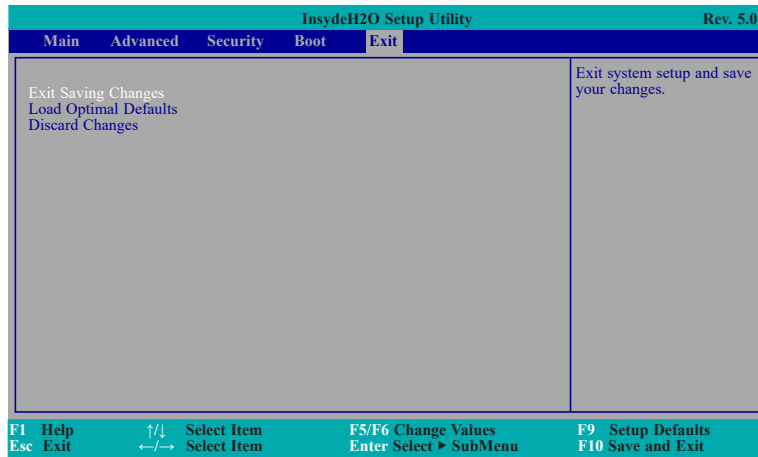

Exit Saving Changes

Select Yes and press <Enter> to exit the system setup and save your changes.

Load Optimal Defaults

Select YES and press <Enter> to load optimal defaults.

Discard Changes

Select YES and press <Enter> to exit the system setup without saving your changes.

Updating the BIOS

To update the BIOS, you will need the new BIOS file and a flash utility. Please contact technical support or your sales representative for the files.

Notice: BIOS SPI ROM

1. The Intel® Management Engine has already been integrated into this system board. Due to the safety concerns, the BIOS (SPI ROM) chip cannot be removed from this system board and used on another system board of the same model.
2. The BIOS (SPI ROM) on this system board must be the original equipment from the factory and cannot be used to replace one which has been utilized on other system boards.
3. If you do not follow the methods above, the Intel® Management Engine will not be updated and will cease to be effective.

**Note:**

- a. You can take advantage of flash tools to update the default configuration of the BIOS (SPI ROM) to the latest version anytime.
- b. When the BIOS IC needs to be replaced, you have to populate it properly onto the system board after the EEPROM programmer has been burned and follow the technical person's instructions to confirm that the MAC address should be burned or not.

Chapter 4 - Supported Software

Please contact technical support or your sales representative for the drivers, utilities and software applications required to enhance the performance of the system board.

Intel Chipset Software Installation Utility

The Intel Chipset Software Installation Utility is used for updating Windows® INF files so that the Intel chipset can be recognized and configured properly in the system.

To install the utility, download “SU256-SCM Chipset Driver” zip file.

1. Setup is ready to install the utility. Click “Next”.

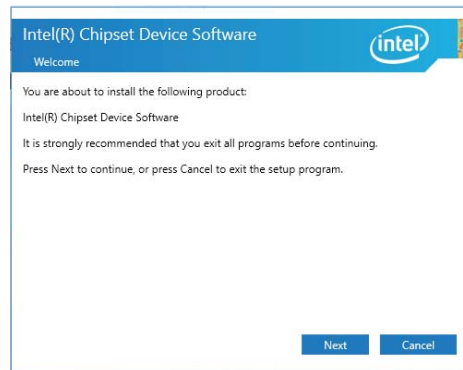

2. Read the license agreement then click “Accept”.

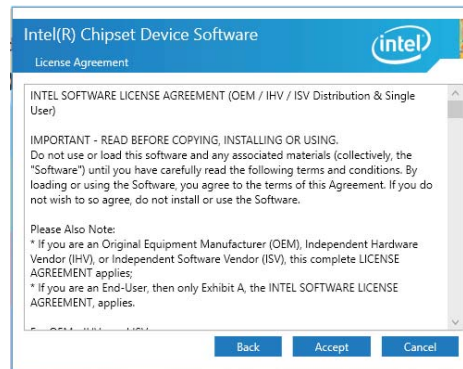

3. Go through the readme document for more installation tips then click “Install”.

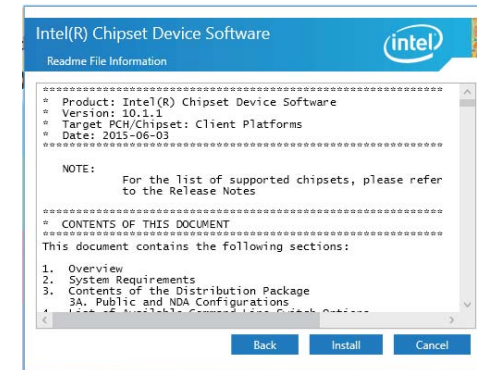

4. The step displays the installing status in the progress.

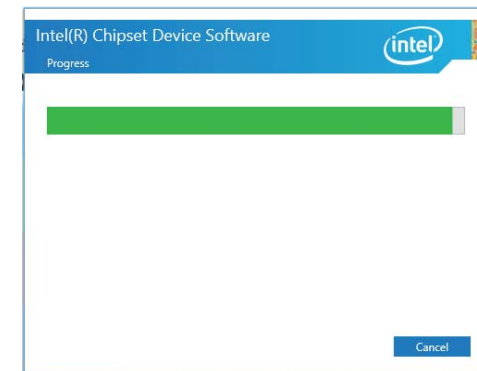

5. After completing installation, click “Restart Now” to exit setup.

Restarting the system will allow the new software installation to take effect.



Intel® Rapid Storage Technology

The Intel Rapid Storage Technology is a utility that allows you to monitor the current status of the SATA drives. It enables enhanced performance and power management for the storage subsystem.

To install the driver, download “SU256-SCM IRST Driver” zip file.

1. Setup is ready to install the utility. Click “Next”.

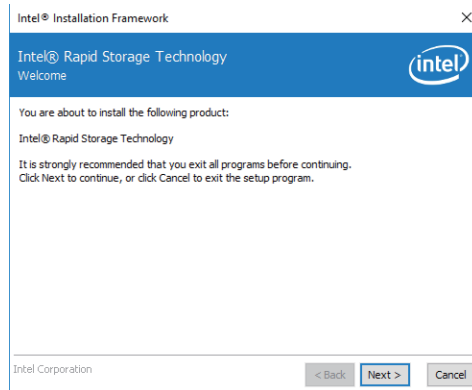

2. Read the license agreement and click “I accept the terms in the License Agreement”. Then, click “Next”.

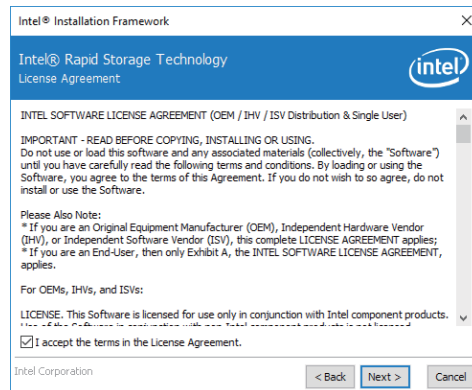

3. Go through the readme document to view system requirements and installation information then click “Next”.

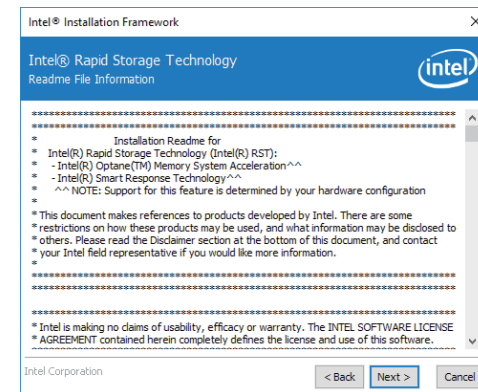

4. Click “Next” to install to the default folder or click “change to choose another destination folder”.

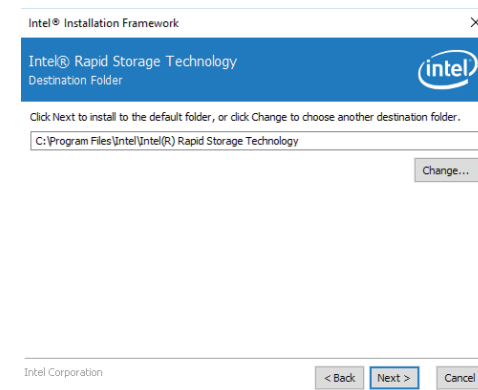

5. Confirm the installation and click “Next”.

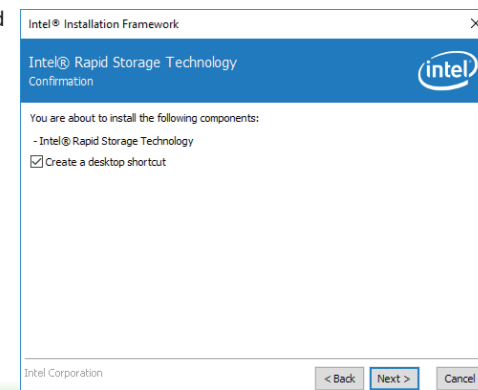

6. Click “Yes, I want to restart this computer now” to complete the installation and then click “Finish”.

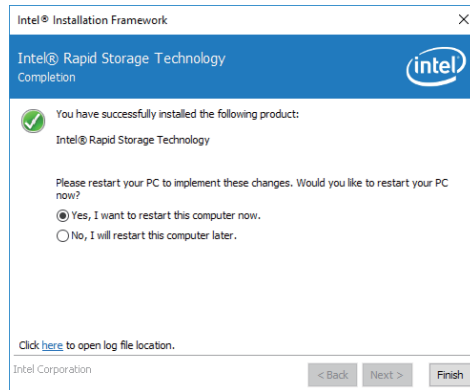

Intel Graphics Drivers

To install the driver, download “SU256-SCM Graphics Driver” zip file.

1. Setup is now ready to install the graphics driver. Click “Next”.

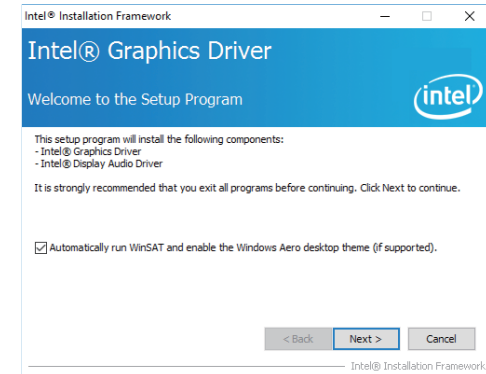

By default, the “Automatically run WinSAT and enable the Windows Aero desktop theme” is enabled. With this enabled, after installing the graphics driver and the system rebooted, the screen will turn blank for 1 to 2 minutes (while WinSAT is running) before the Windows 10 desktop appears. The “blank screen” period is the time Windows is testing the graphics performance.

We recommend that you skip this process by disabling this function then click “Next”.

2. Read the license agreement then click “Yes”.

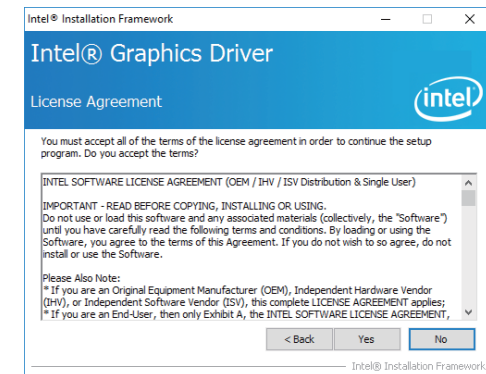

- Go through the readme document for system requirements and installation tips then click "Next".

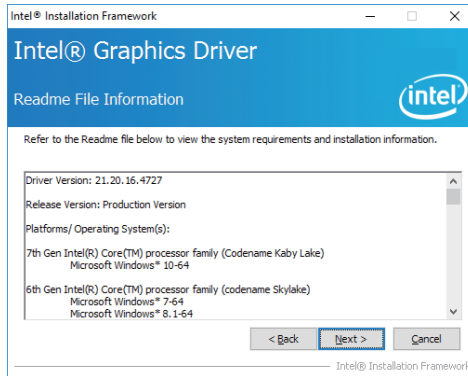

- Setup is now installing the driver. Click "Next" to continue.

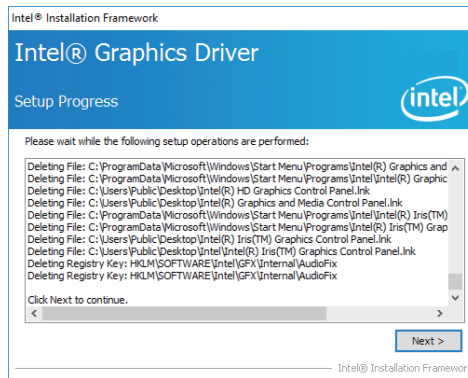

- Click "Yes, I want to restart this computer now" then click "Finish".

Restarting the system will allow the new software installation to take effect.

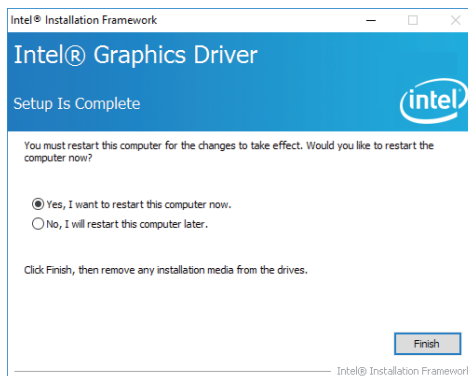

Intel LAN Driver

To install the driver, download "SU256-SCM LAN Driver" zip file.

- Setup is ready to install the driver. Click "Next".

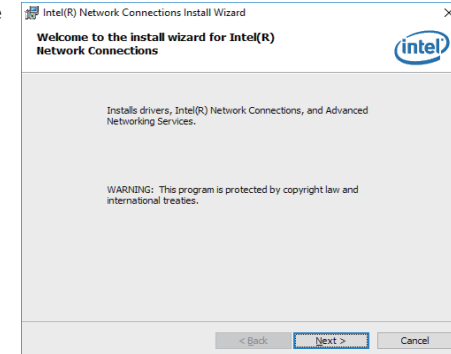

- Click "I accept the terms in the license agreement" then click "Next".

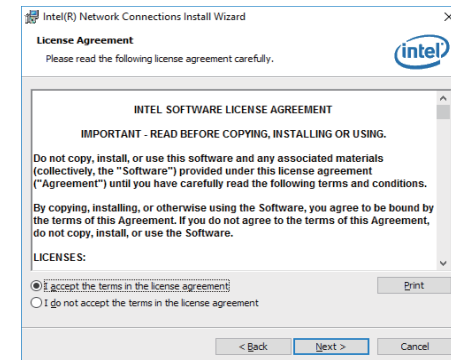

- Select the program features you want installed then click "Next".

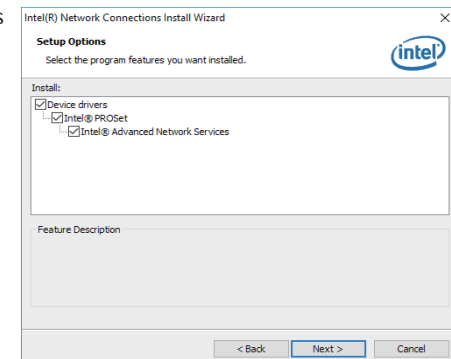

4. Click "Install" to begin the installation.

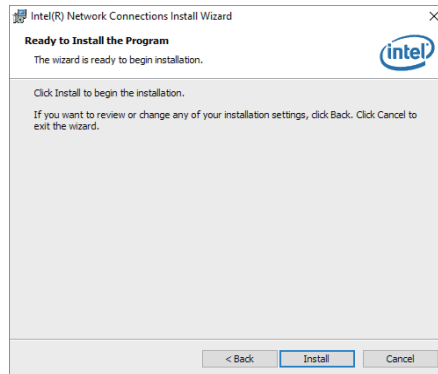

5. The step displays the installing status in the progress.

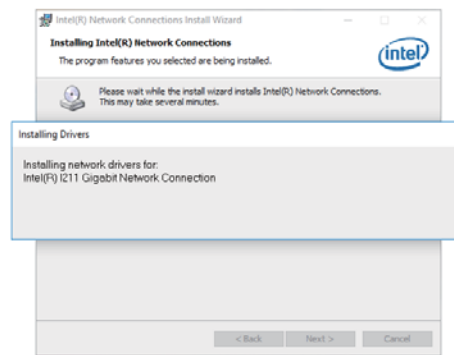

6. After completing installation, click "Finish".

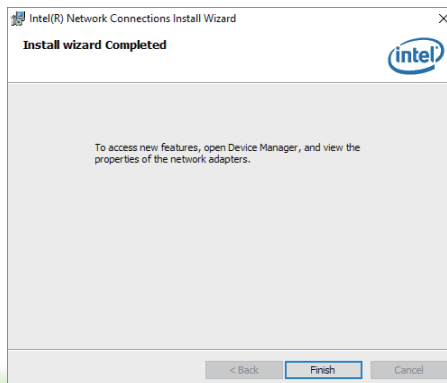

Intel Management Engine Driver

To install the driver, download "SU256-SCM ME Driver" zip file.

1. Setup is ready to install the driver. Click "Next".

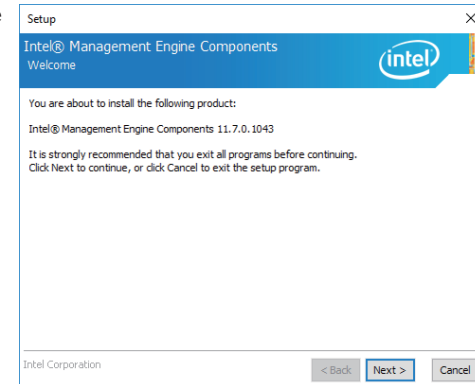

2. Read the license agreement then tick "I accept the terms in the License Agreement". Click "Next".

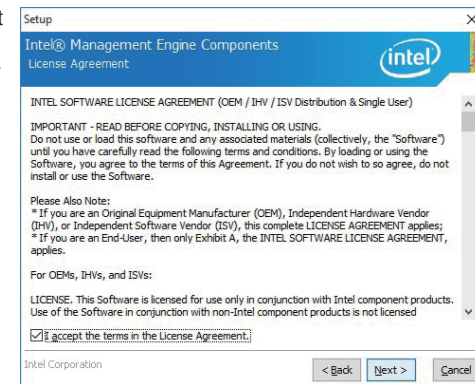

- Click "Next" to install to the default folder, or click "Change" to choose another destination folder.

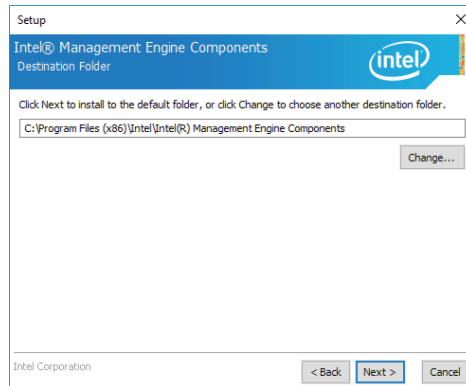

- Please wait while the product is being installed.

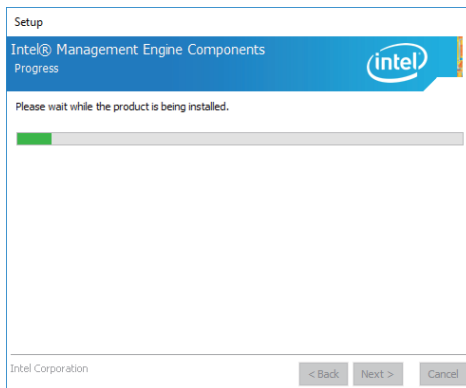

- After completing installation, click "Finish".

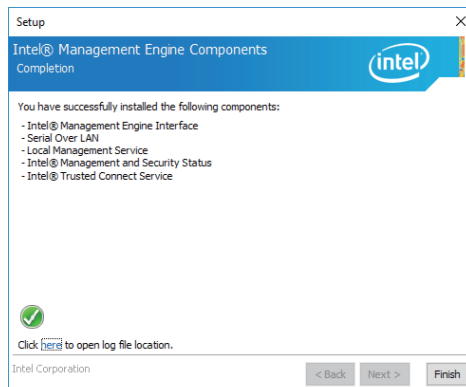

SIO Driver (Windows 10)

To install the driver, download "SU256-SCM SIO Driver W10x64" zip file.

- Setup is ready to install the driver. Click "Next".

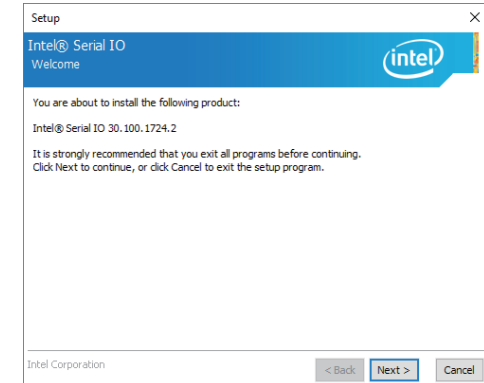

- Read the license agreement carefully. Tick "I accept the terms in the License Agreement" then click "Next".

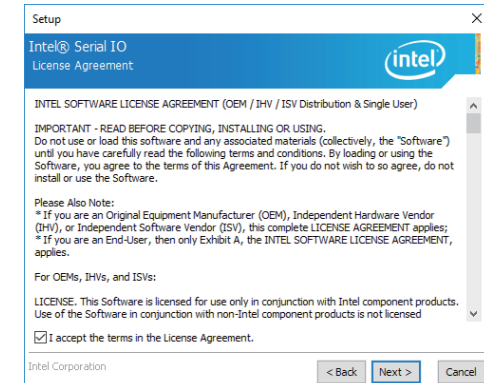

3. Go through the readme document for system requirements and installation tips then click "Next".

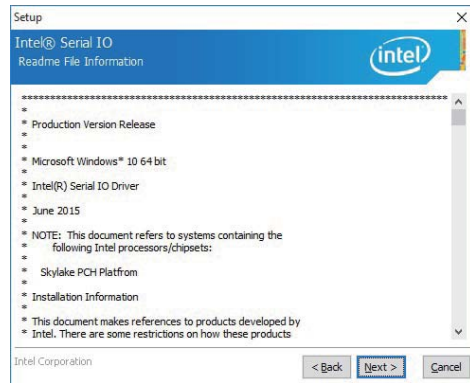

4. Setup is ready to install the driver. Click "Next".

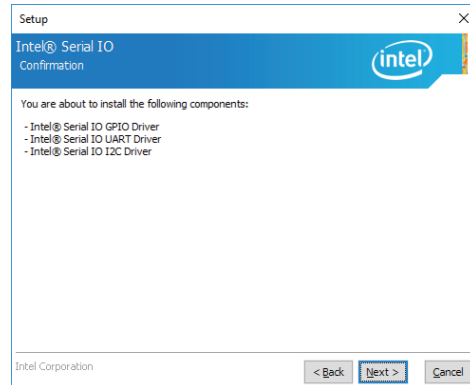

5. Setup is now installing the driver.

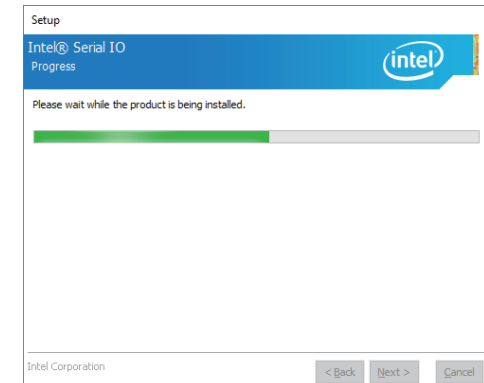

6. Click "Yes, I want to restart this computer now" then click "Finish".

Restarting the system will allow the new software installation to take effect.

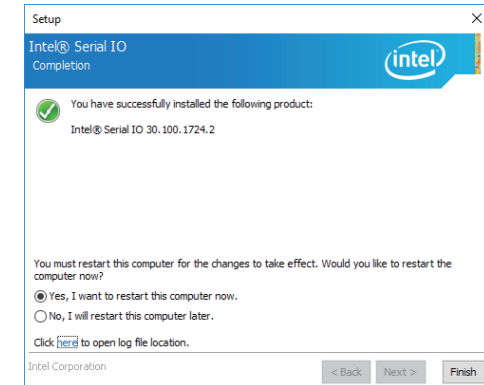

SIO Driver (Windows 8.1)

To install the driver, download "SU256-SCM SIO Driver W8.1x64" zip file.

1. Setup is ready to install the driver.
Click "Next".

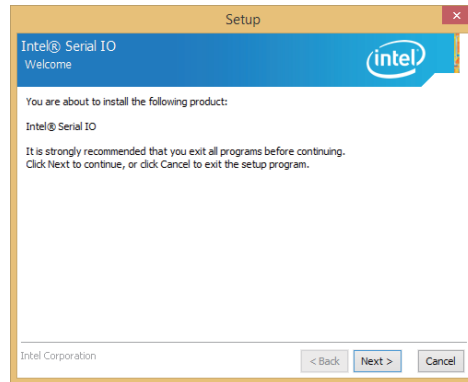

2. Read the license agreement carefully.
Tick "I accept the terms in the License Agreement" then click "Next".

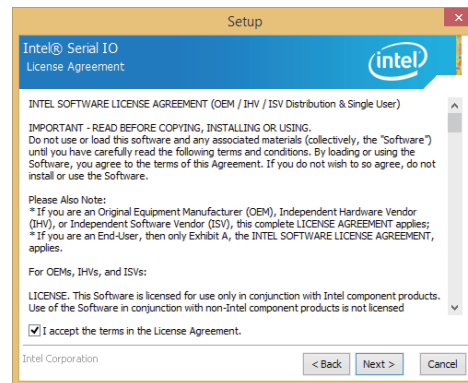

3. Go through the readme document for system requirements and installation tips then click "Next".

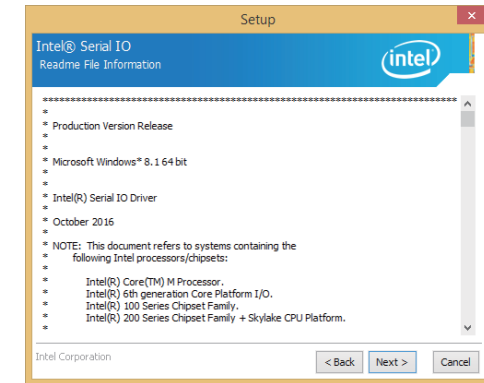

4. Setup is ready to install the driver.
Click "Next".

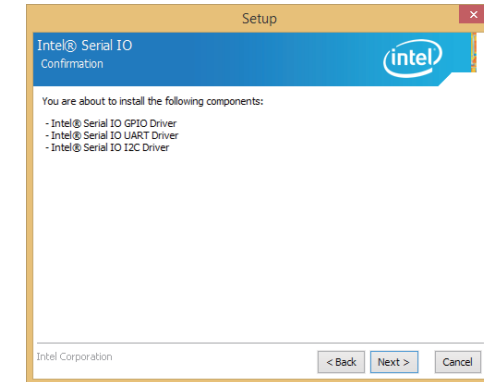

5. Setup is now installing the driver.

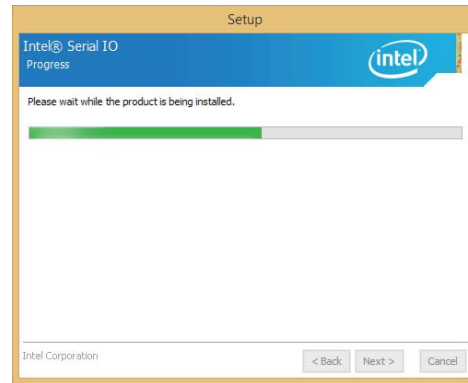

6. Click "Yes, I want to restart this computer now" then click "Finish".

Restarting the system will allow the new software installation to take effect.

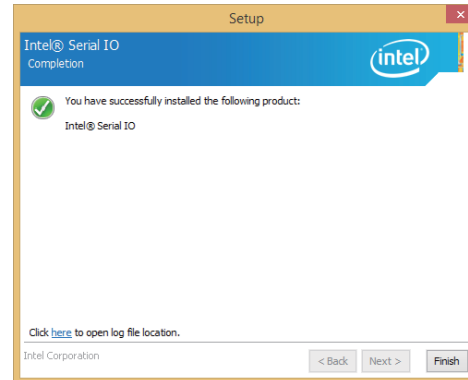

SIO Driver (Windows 7)

To install the driver, download "SU256-SCM SIO Driver W7x64" zip file.

1. Setup is ready to install the driver. Click "Next".

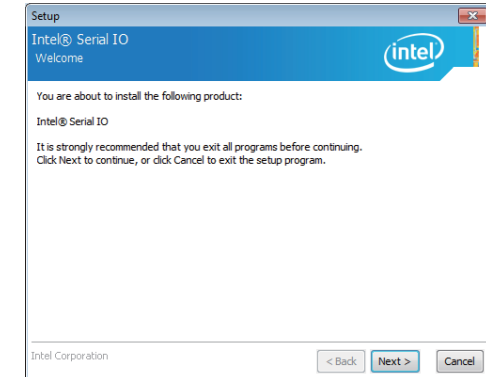

2. Read the license agreement carefully. Tick "I accept the terms in the License Agreement" then click "Next".

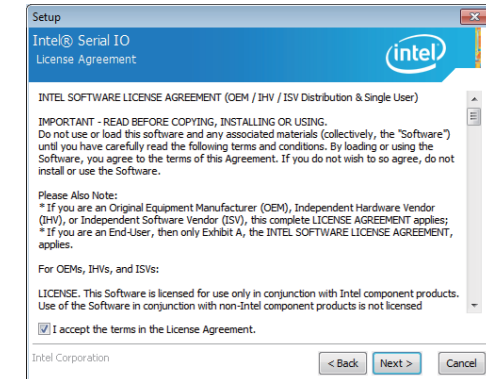

3. Go through the readme document for system requirements and installation tips then click "Next".

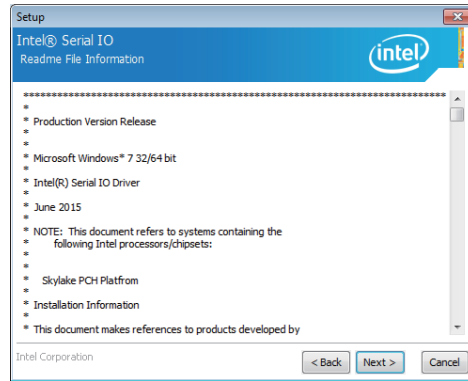

4. Setup is ready to install the driver. Click "Next".



5. Setup is now installing the driver.

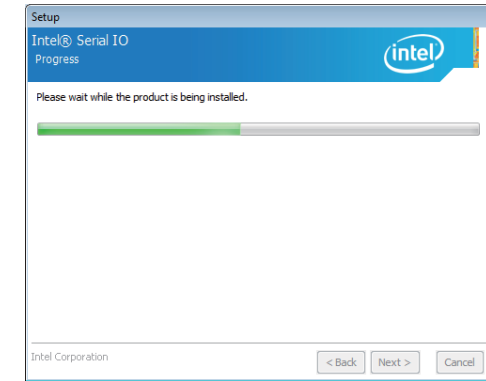

6. Click "Yes, I want to restart this computer now" then click "Finish".

Restarting the system will allow the new software installation to take effect.

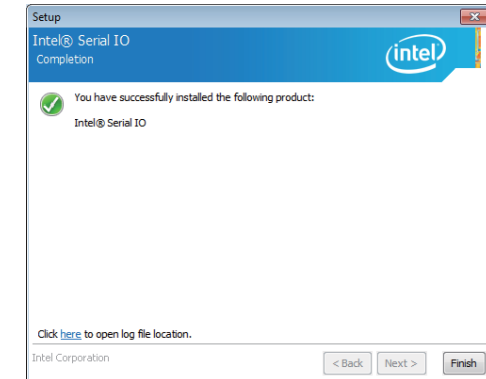

Intel USB 3.0 Driver (Windows 8.1)

To install the driver, download "SU256-SCM USB3.0 Driver W8.1x64".

1. Setup is ready to install the driver. Click "Next".

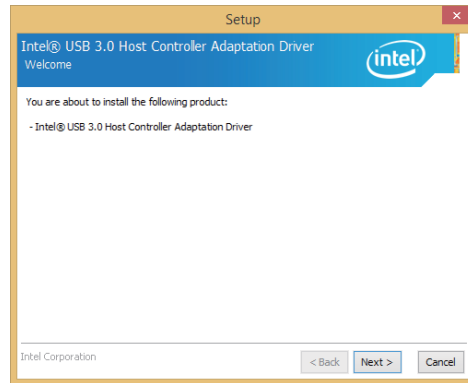

2. Read the license agreement then tick "I accept the terms in the license agreement". Click "Next".

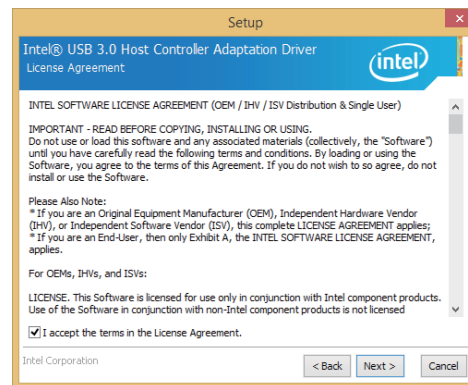

3. Click "Next".

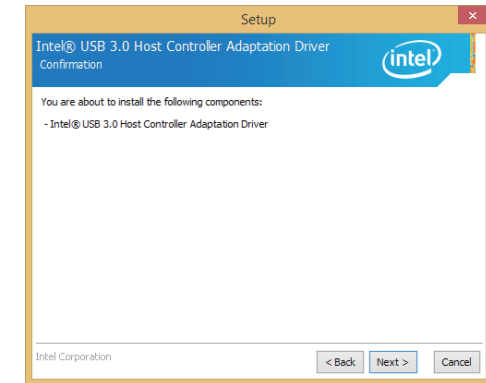

4. Setup is currently installing the driver. After installation has completed, click "Next".

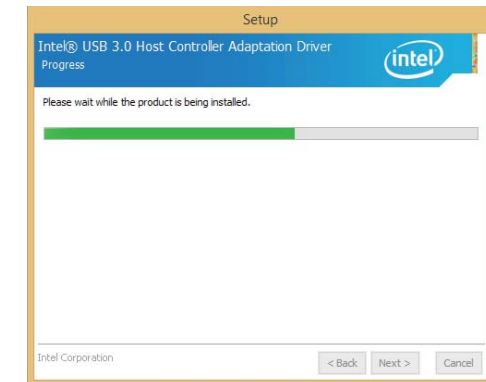

5. Click "Yes, I want to restart this computer now" then click "Finish".

Restarting the system will allow the new software installation to take effect.

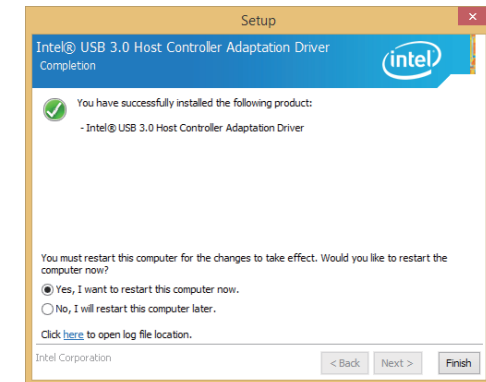

Intel USB 3.0 Driver (Windows 7)

To install the driver, download "SU256-SCM USB3.0 Driver W7x86x64".

1. Setup is ready to install the driver.
Click "Next".

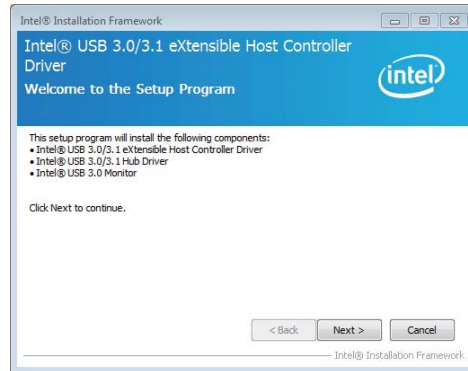

2. Read the license agreement then click "Yes".

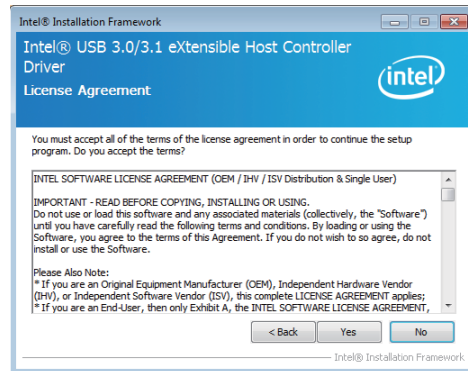

3. Read the Readme File Information then click "Next".

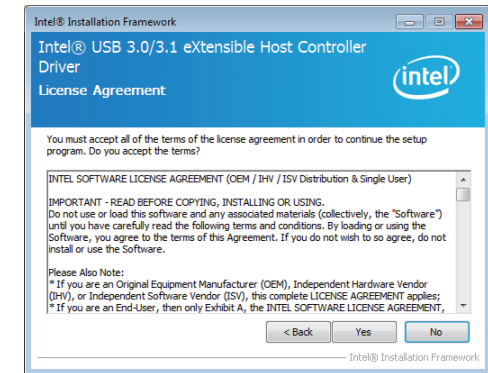

5. Setup is currently installing the driver. After installation has completed, click "Next".

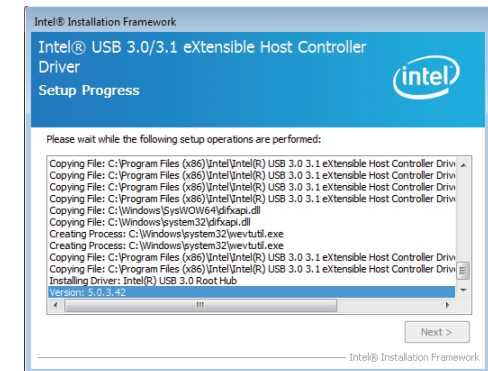

6. Click "Finish".

Restarting the system will allow the new software installation to take effect.

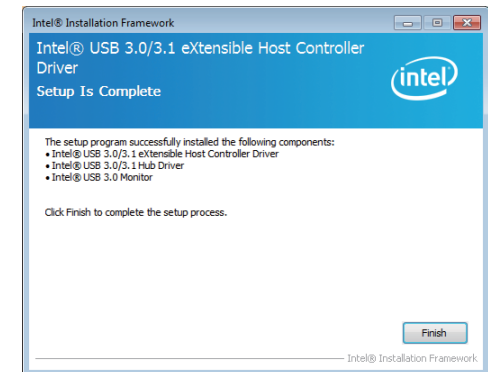

Microsoft Framework 4.5.2 (For Windows 7 only)

Note:

Before installing Microsoft Framework 4.5.2, make sure you have updated your Windows 7 operating system to Service Pack 3.

To install the driver, download “SU256-SCM DotNetFx45” zip file at our website.

1. Setup is now extracting files.

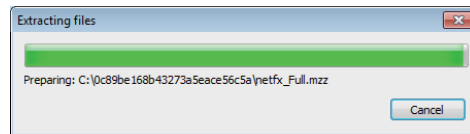

2. Read the license agreement carefully.

Click “I have read and accept the terms of the License Agreement” then click “Install”.

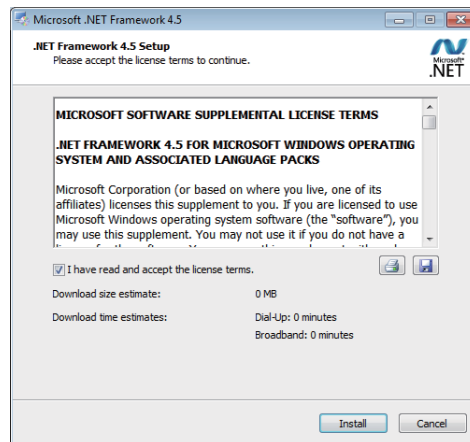

3. Setup is now installing the driver.

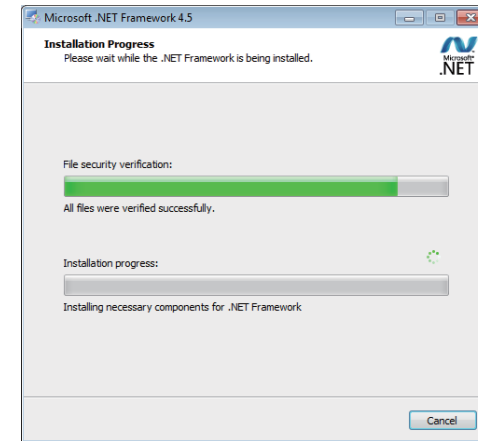

4. Click “Finish”.

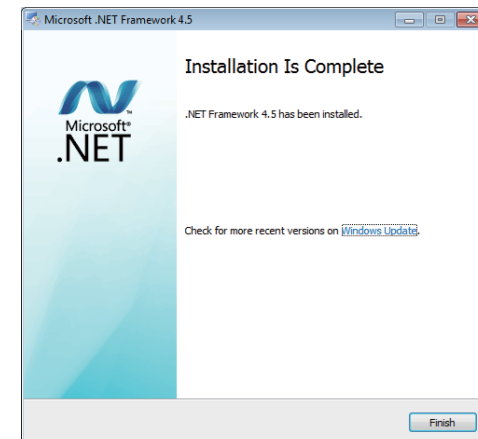

Kernel Mode Driver Framework (For Windows 7 only)

To install the driver, download “SU256-SCM KMDf” zip file at our website.

1. Click “Yes” to install the update.



2. The update is installed now.

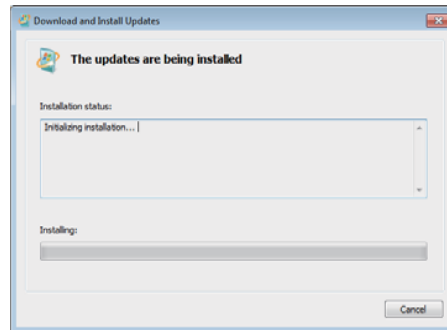

3. Click “Restart Now” to restart your computer when the installation is complete.

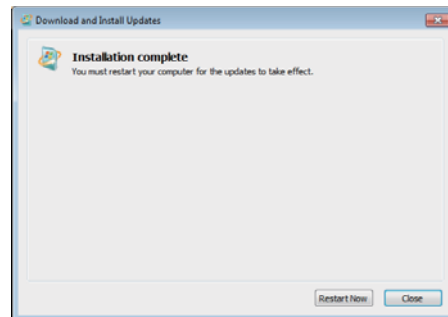

Infineon TPM 2.0 Driver (For Windows 7 64-bit only)

To install the driver, download “SU256-SCM TPM2.0 Hotfix” zip file at our website.

1. Click “OK”.

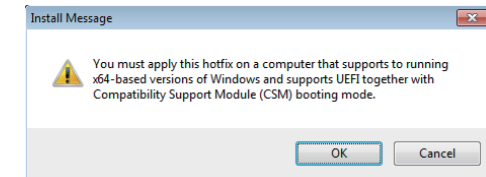

2. Click “Yes”.

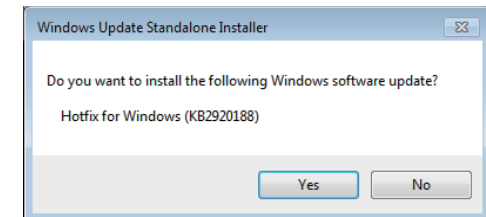

3. Setup is now installing the updates.

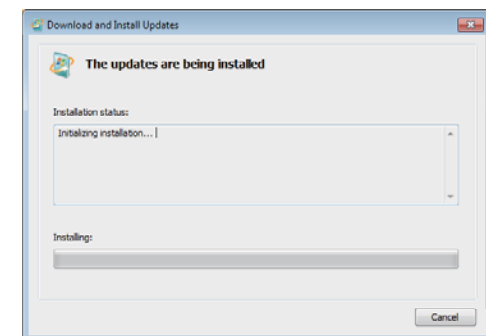

- Click "Restart now" to restart your system.

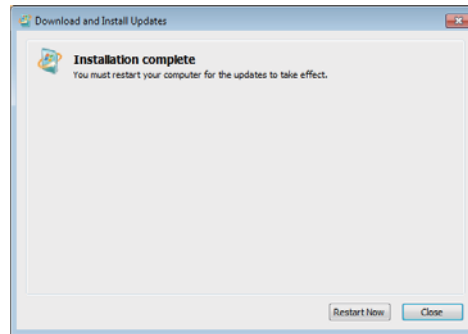

Chapter 5 - RAID

The system board allows configuring RAID on Serial ATA drives. It supports RAID 0 and RAID 1.

RAID Levels

RAID 0 (Striped Disk Array without Fault Tolerance)

RAID 0 uses two new identical hard disk drives to read and write data in parallel, interleaved stacks. Data is divided into stripes and each stripe is written alternately between two disk drives. This improves the I/O performance of the drives at different channel; however it is not fault tolerant. A failed disk will result in data loss in the disk array.

RAID 1 (Mirroring Disk Array with Fault Tolerance)

RAID 1 copies and maintains an identical image of the data from one drive to the other drive. If a drive fails to function, the disk array management software directs all applications to the other drive since it contains a complete copy of the drive's data. This enhances data protection and increases fault tolerance to the entire system. Use two new drives or an existing drive and a new drive but the size of the new drive must be the same or larger than the existing drive.

Settings

To enable the RAID function, the following settings are required.

1. Connect the Serial ATA drives.
2. Enable RAID in the Insyde BIOS.
3. Create a RAID volume.
- 3-1. Create a RAID volume if the boot type is UEFI.
4. Install the Intel Rapid Storage Technology Utility.

Step 1: Connect the Serial ATA Drives

Refer to chapter 2 for details on adjusting the jumper to mSATA signal (P.11), connecting the Serial ATA drives and installing an mSATA card in the mini PCIe slot (P. 16).

**Important:**

1. Make sure you have installed the Serial ATA drives and connected the data cable. Otherwise you will not be able to enter the RAID BIOS utility.
2. Treat the cable with extreme caution, especially while creating RAID. A damaged cable will ruin the entire installation process and operating system. The system will not boot and you will lose all data in the hard drives. Please give special attention to this warning because there is no way of recovering back the data.

Step 2: Enable RAID in the Insyde BIOS

1. Power-on the system then press to enter the main menu of the Insyde BIOS.
2. Go to "Advanced" menu, and select the "SATA Configuration" submenu.
3. Change the "SATA Mode Selection" to "RAID" mode.
4. Save the changes in the "Exit" menu.
5. Reboot the system.

Step 3: Create a RAID Volume

1. When the Intel® RST option ROM status screen displays during POST, press <Ctrl> and <I> simultaneously to enter the option ROM user interface.
2. Select 1: Create RAID Volume and press <Enter>.
3. Use the up or down arrow keys to select the RAID level and press <Enter>.
4. Use the up or down arrow keys to select the strip size and press <Enter>.
5. Select the capacity and press <Enter>. You must select less than one hundred percent of the available volume space to leave space for the second volume.
6. Press <Enter> to create the volume.
7. At the prompt, press <Y> to confirm volume creation.
8. Select 4: Exit and press <Enter>.
9. Press <Y> to confirm exit.

Step 3-1: Create a RAID Volume if the boot type is UEFI

If the boot type is set to UEFI, RAID volume creation will be different. Please use the following steps to create RAID volumes. To set the boot type, enter the Insyde BIOS and go to "Boot" > "Boot Type".

1. Go to the "Advanced" menu of the Insyde BIOS and select UEFI Device Manager, and press Enter. In the Device Manager menu, select Intel(R) Rapid Storage Technology and press Enter.

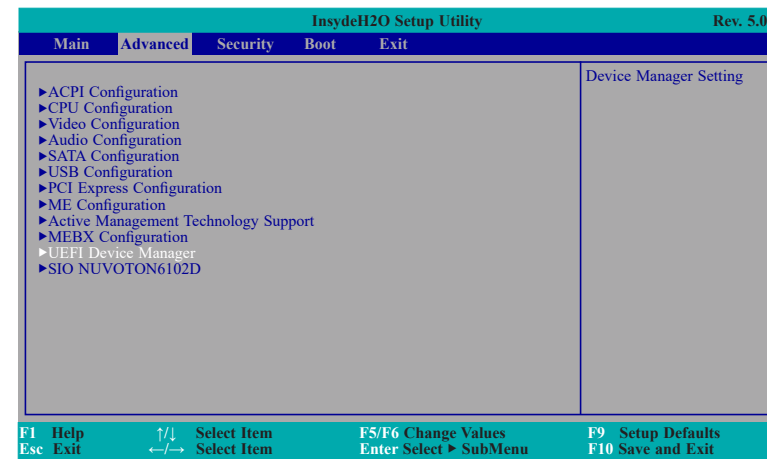

2. The screen displays all available drives. Select "Create RAID volume" to create a RAID volume.
3. Use the up or down arrow keys to select the RAID level and press <Enter>.
4. Use the up or down arrow keys to scroll through the list of hard drives and press <Enter> to select the drive.
5. Press <Enter>.
6. Use the up or down arrow keys to select the strip size and press <Enter>.
7. Enter the volume size and press <Enter>.
8. At the prompt, press <Y> to confirm volume creation.

Step 4: Install the Intel Rapid Storage Technology Utility

The Intel Rapid Storage Technology is a utility that allows you to monitor the current status of the SATA drives. It enables enhanced performance and power management for the storage subsystem.

To install the driver, click "SU256-SCM_IRST" on the main menu. Please refer to **Chapter 4** for more information.

Chapter 6 - Intel AMT Settings

Overview

Intel Active Management Technology (Intel® AMT) combines hardware and software solution to provide maximum system defense and protection to networked systems.

The hardware and software information are stored in non-volatile memory. With its built-in manageability and latest security applications, Intel® AMT provides the following functions.

- **Discover**

Allows remote access and management of networked systems even while PCs are powered off; significantly reducing desk-side visits.

- **Repair**

Remotely repair systems after OS failures. Alerting and event logging help detect problems quickly to reduce downtime.

- **Protect**

Intel AMT's System Defense capability remotely updates all systems with the latest security software. It protects the network from threats at the source by proactively blocking incoming threats, reactively containing infected clients before they impact the network, and proactively alerting when critical software agents are removed.

Enable Intel® AMT in the Insyde BIOS

1. Power-on the system then press to enter the main menu of the Insyde BIOS.
2. In the **Advanced** menu, select **Active Management Technology Support**.

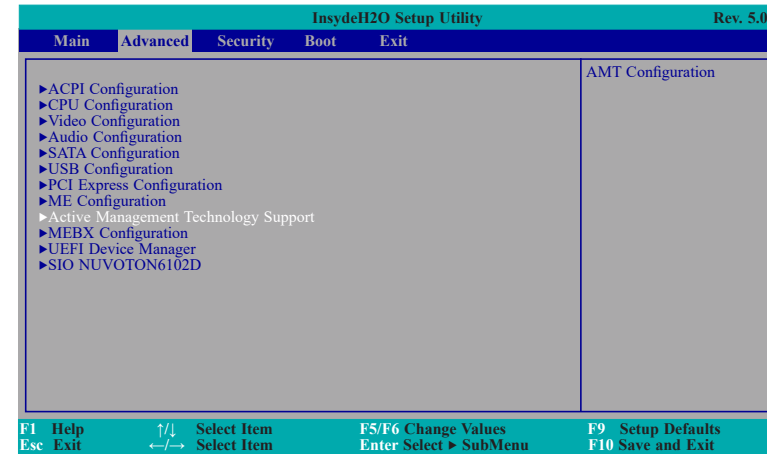

3. Select **Enabled** in the **Intel AMT Support** field.

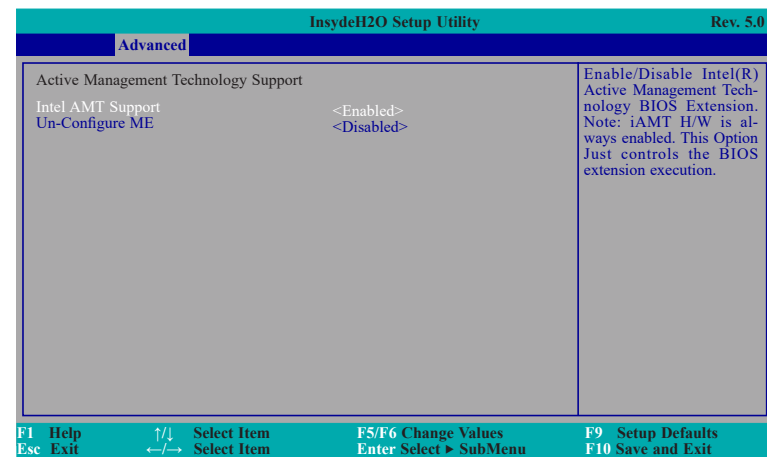

- In the **Exit** menu, select **Exit Saving Changes** then select **Yes** and press Enter.

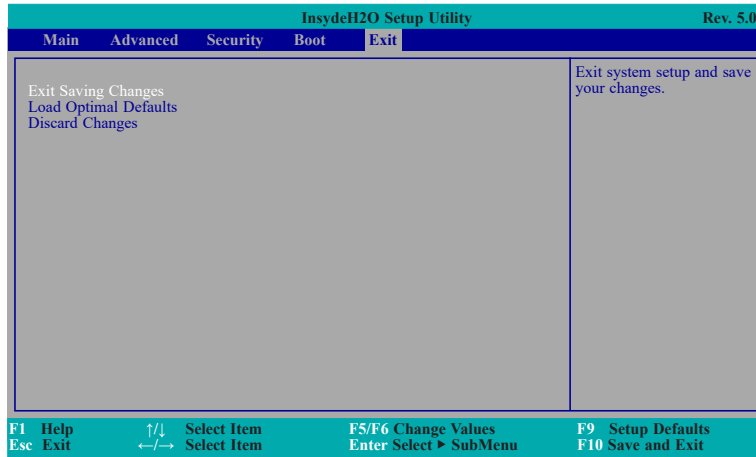

Configure Intel® AMT in the Intel® Management Engine BIOS Extension (MEBX) Section

- After the system reboots, press to enter the main menu of the Insyde BIOS.
- In the **Advanced** menu, select **MEBX Configuration**.

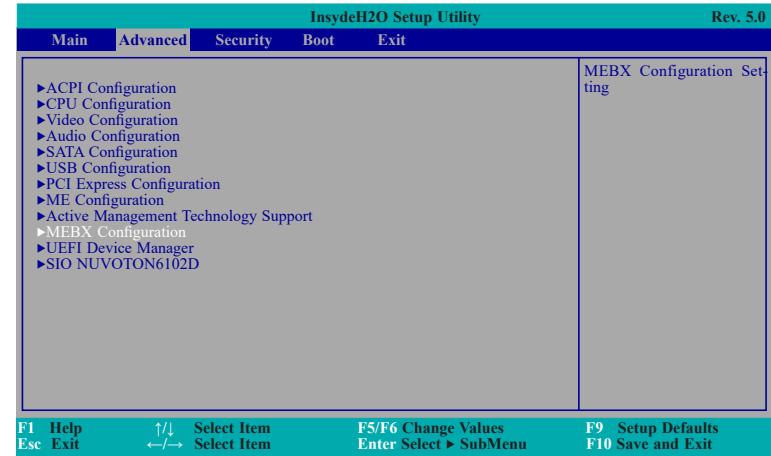

- Under **MEBX Configuration** page, press Enter again to launch MEBX setup system.

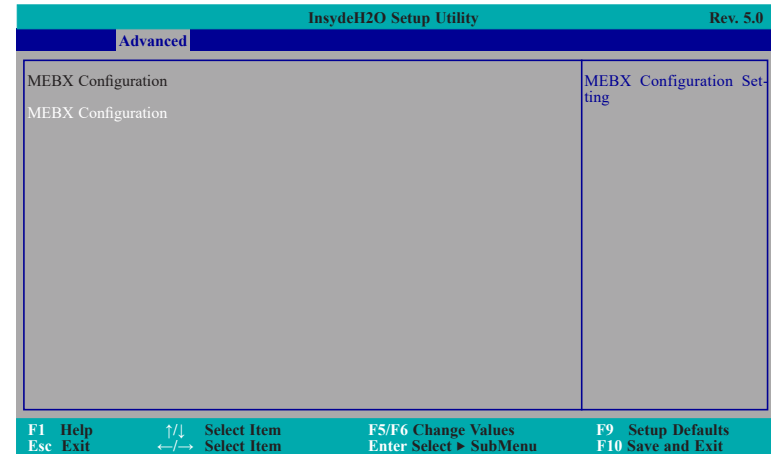

4. Select **MEBx Login** and press Enter. You will be prompted for a password. The default password is "admin". Enter the default password in the space provided under Intel(R) ME Password then press Enter.

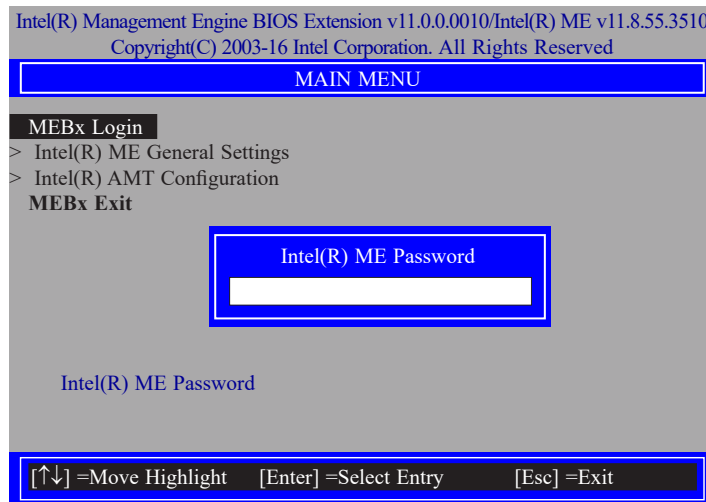

5. Enter a new password in the space provided under Intel(R) ME New Password then press Enter. The password must include:

- 8-32 characters
- Strong 7-bit ASCII characters excluding : , and " characters
- At least one digit character (0, 1, ...9)
- At least one 7-bit ASCII non alpha-numeric character, above 0x20, (e.g. !, \$, ;)
- Both lower case and upper case characters

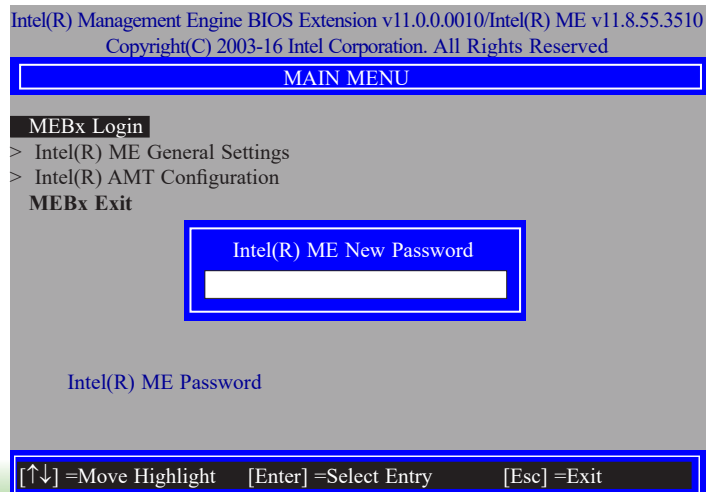

6. You will be asked to verify the new password. Enter the same new password in the space provided under Verify Password then press Enter.

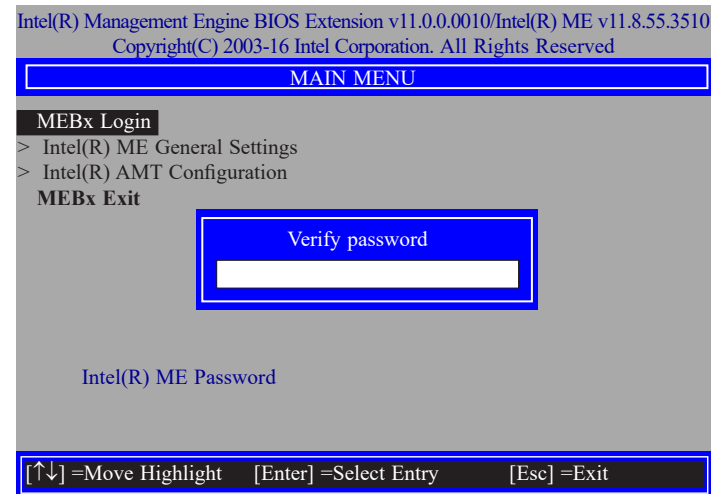

7. Select **Intel(R) ME General Settings** then press Enter.

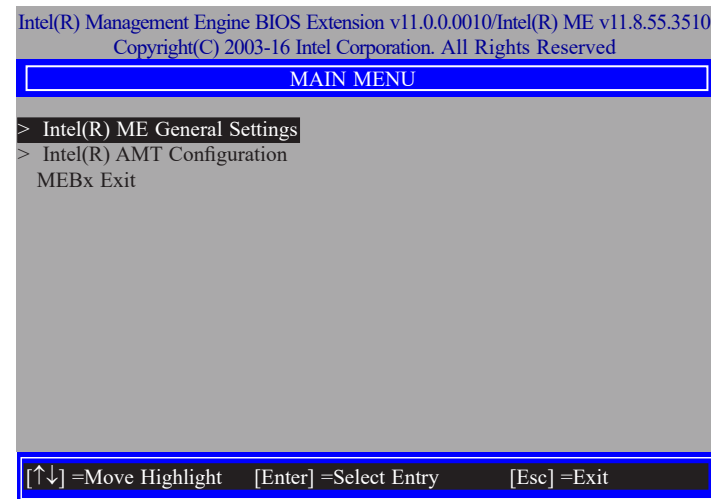

8. If you want to change ME password, select **Change ME Password** then press Enter. Enter the current password in the space provided under Intel(R) ME Password then press Enter.

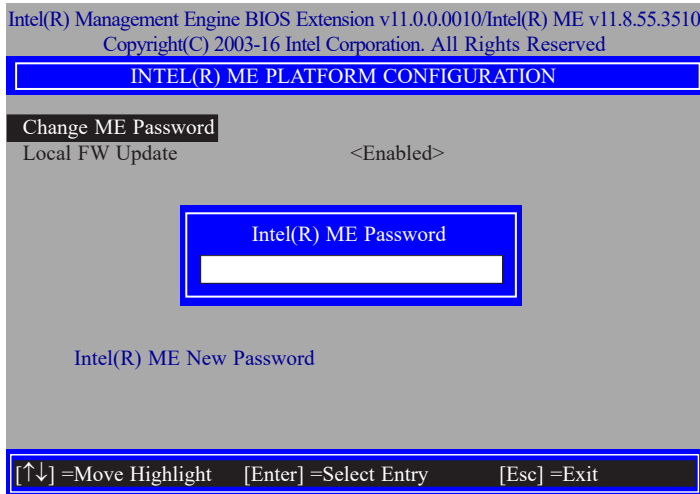

9. Enter a new password in the space provided under Intel(R) ME New Password then press Enter. The password must include:

- 8-32 characters
- Strong 7-bit ASCII characters excluding : , and " characters
- At least one digit character (0, 1, ...9)
- At least one 7-bit ASCII non alpha-numeric character, above 0x20, (e.g. !, \$, ;)
- Both lower case and upper case characters

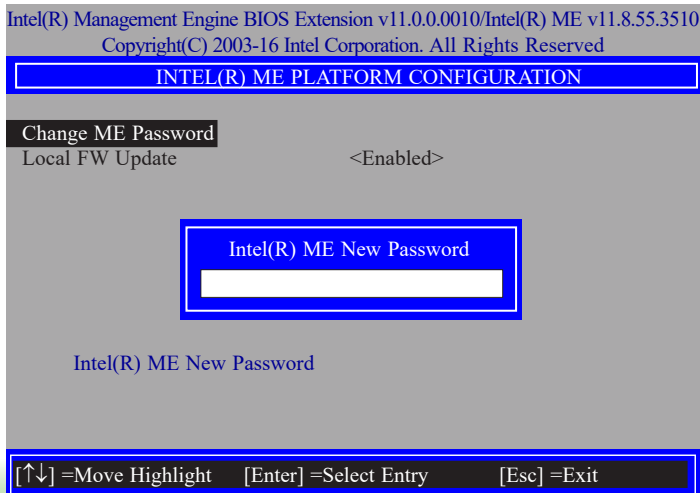

10. You will be asked to verify the new password. Enter the same new password in the space provided under Verify Password then press Enter.

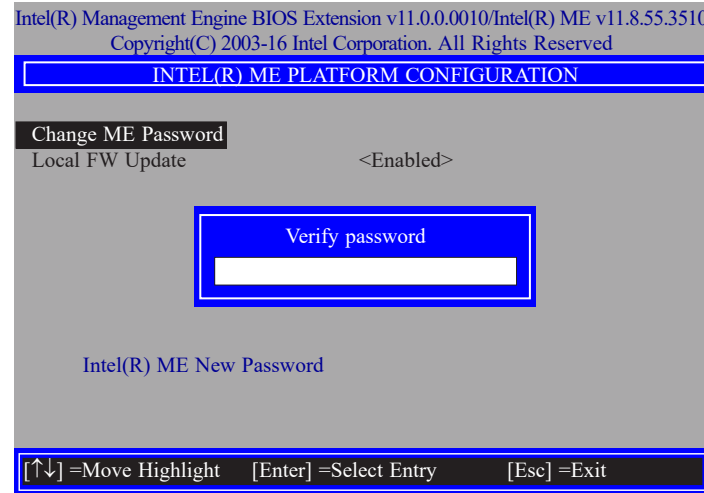

11. Select **Local FW Update** then press Enter. Select **Enabled** or **Disabled** or **Password Protected** then press Enter.

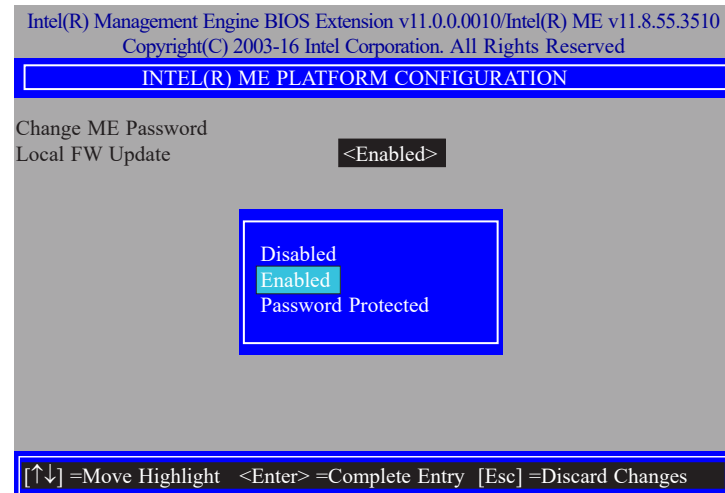

12. Press Esc until you return to the **Main Menu**. Select **Intel(R) AMT Configuration** then press Enter.

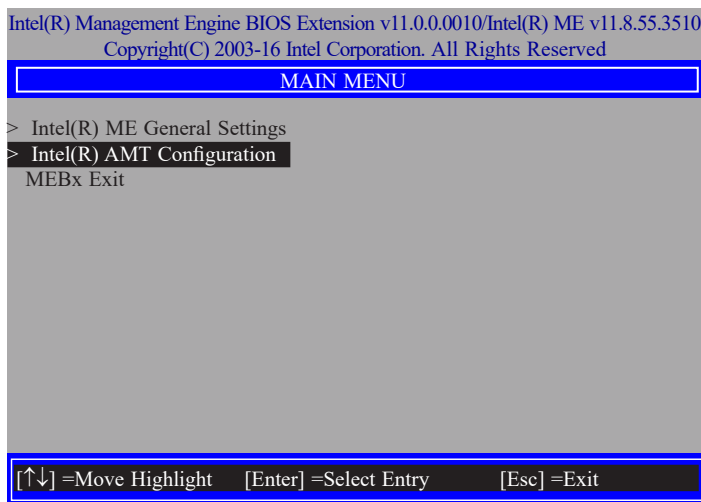

14. In the **Intel(R) AMT Configuration** menu, select **SOL/Storage Redirection/KVM** then press Enter.

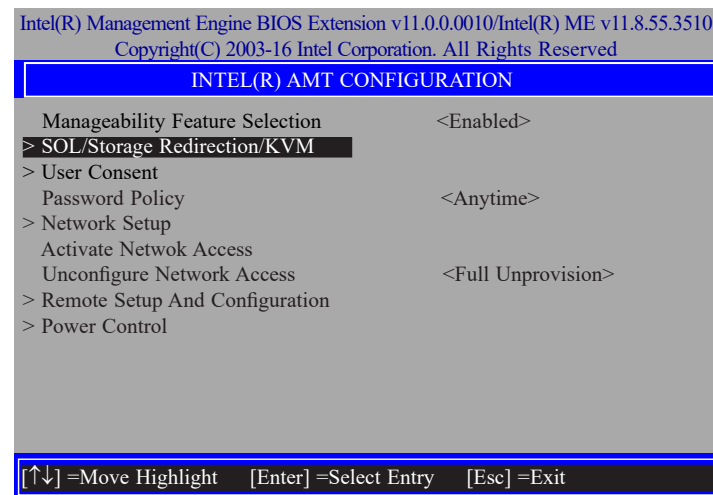

13. In the **Intel(R) AMT Configuration** menu, select **Manageability Feature Selection** then press Enter. Select **Enabled** or **Disabled** then press Enter.

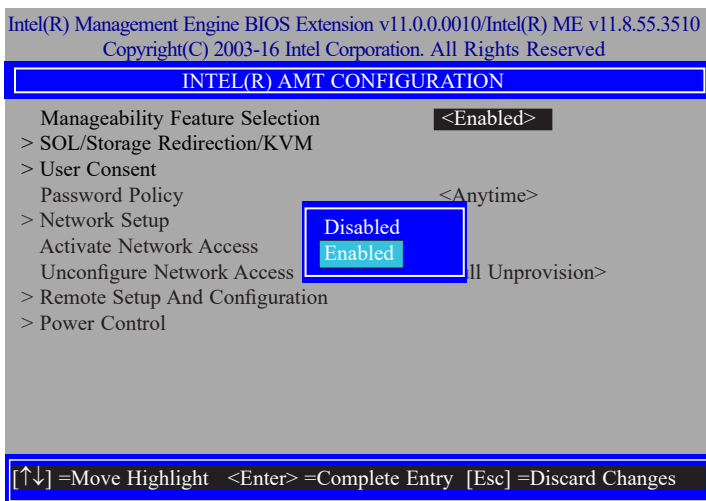

15. In the **SOL/Storage Redirection/KVM** menu, select **Username and Password** then press Enter. Select **Enabled** or **Disabled** then press Enter.

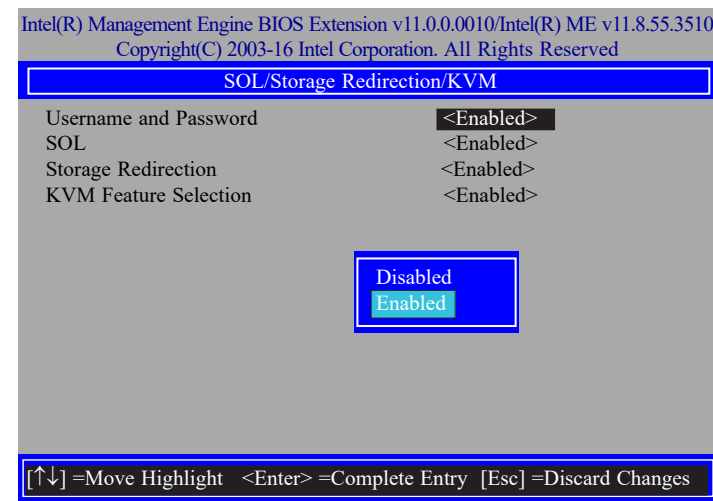

16. In the **SOL/Storage Redirection/KVM** menu, select **SOL** then press Enter. Select **Enabled** or **Disabled** then press Enter.

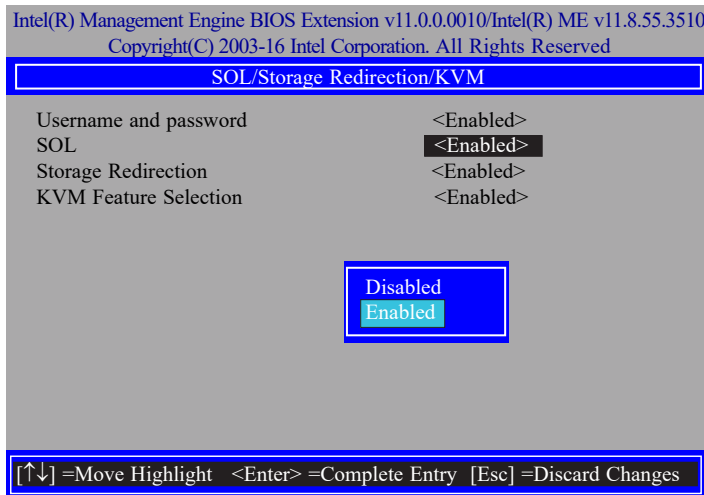

18. In the **SOL/Storage Redirection/KVM** menu, select **KVM Feature Selection** then press Enter. Select **Enabled** or **Disabled** then press Enter.

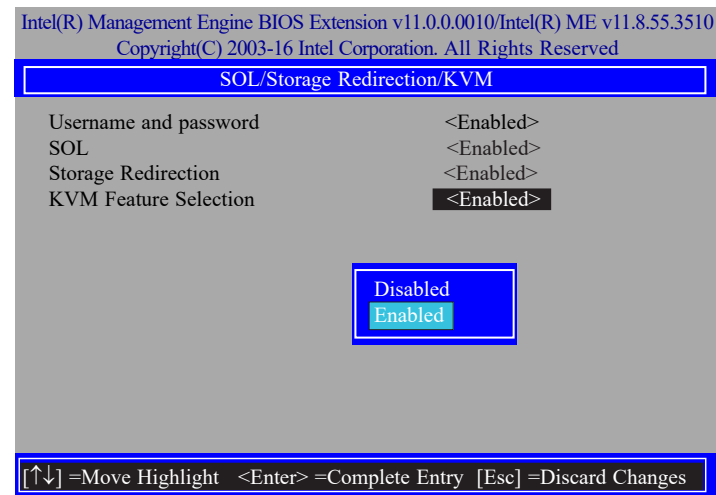

17. In the **SOL/Storage Redirection/KVM** menu, select **Storage Redirection** then press Enter. Select **Enabled** or **Disabled** then press Enter.

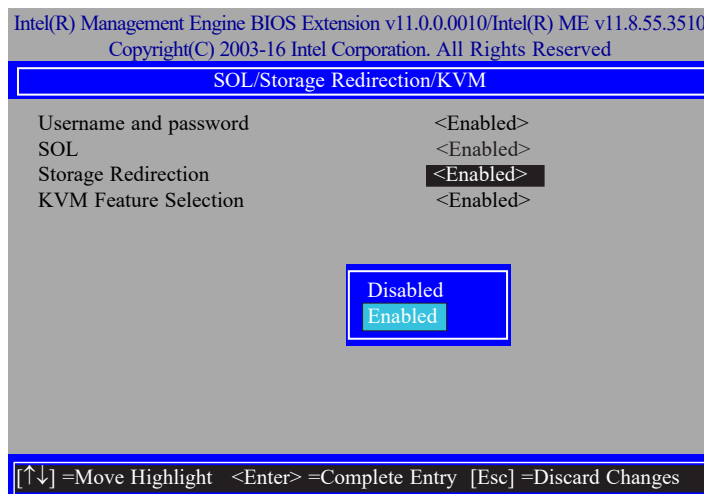

19. Press Esc until you return to the **Intel(R) AMT Configuration** menu. Select **User Consent** then press Enter.

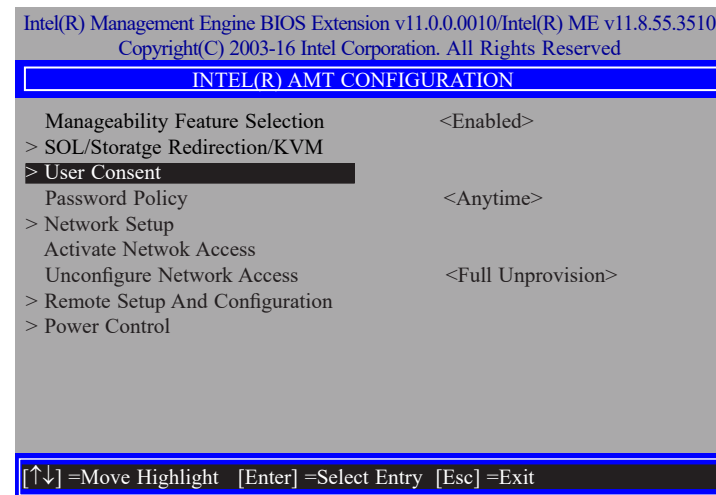

20. In the **User Consent** menu, select **User Opt-in** then press Enter. Select **NONE** or **KVM** or **ALL** then press Enter.

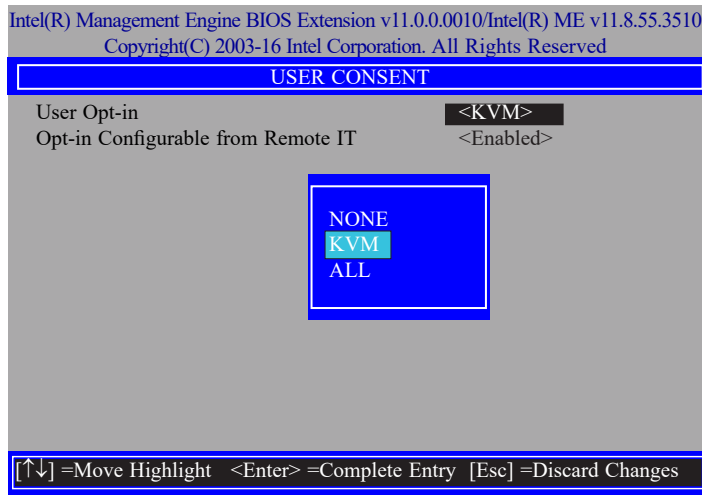

21. In the **User Consent** menu, select **Opt-in Configurable from Remote IT** then press Enter. Select **Enabled** or **Disabled** then press Enter.

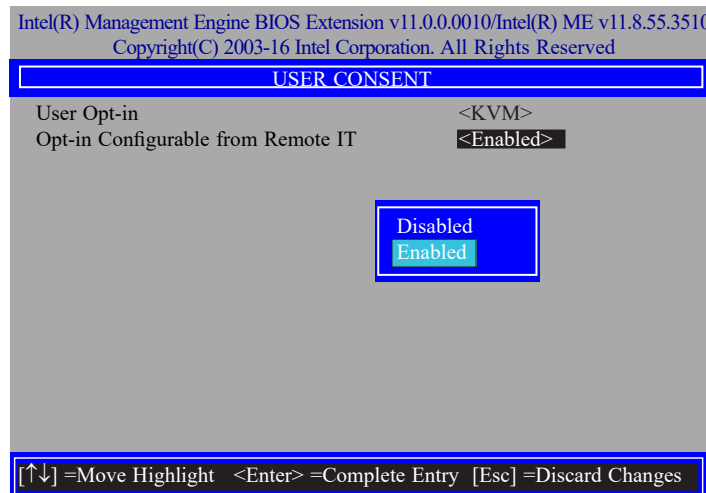

22. Press Esc until you return to the **Intel(R) AMT Configuration** menu. Select **Password Policy** then press Enter.

You may choose to use a password only during setup and configuration or to use a password anytime the system is being accessed.

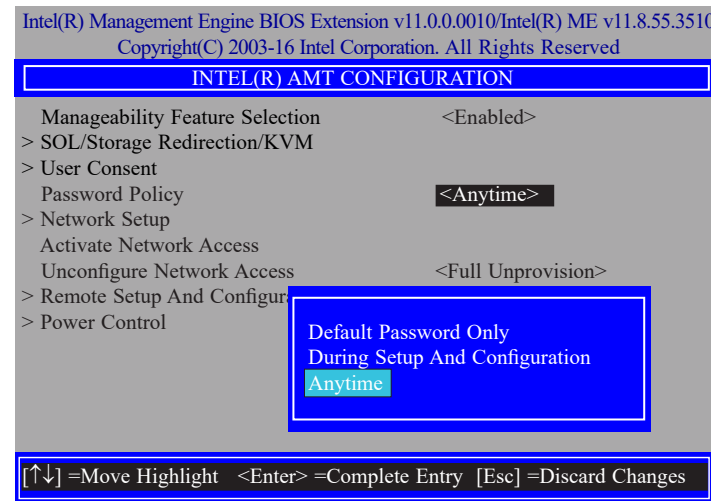

23. In the **Intel(R) AMT Configuration** menu, select **Network Setup** then press Enter.

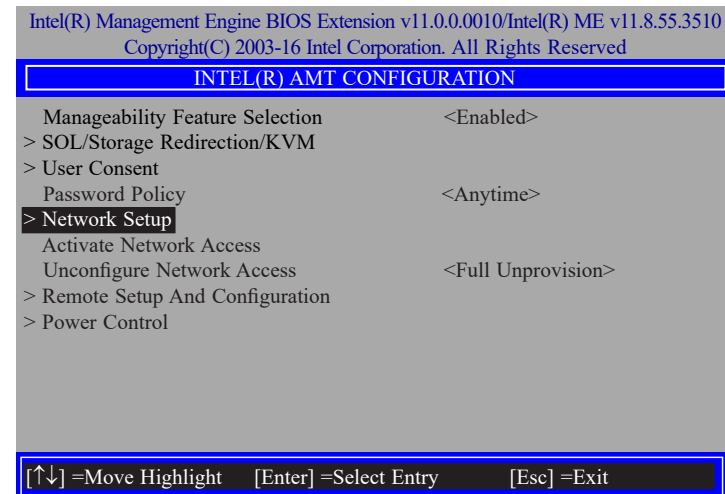

24. In the **Intel(R) ME Network Setup** menu, select **Intel(R) ME Network Name Settings** then press Enter.

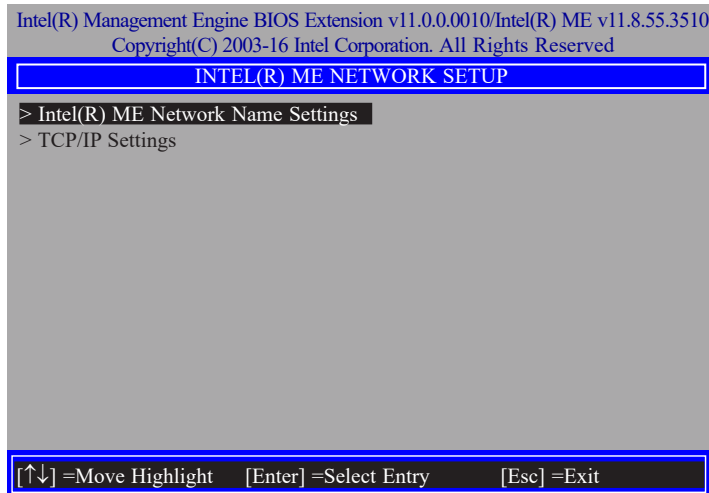

26. Select **Domain Name** then press Enter. Enter the computer's domain name then press Enter.

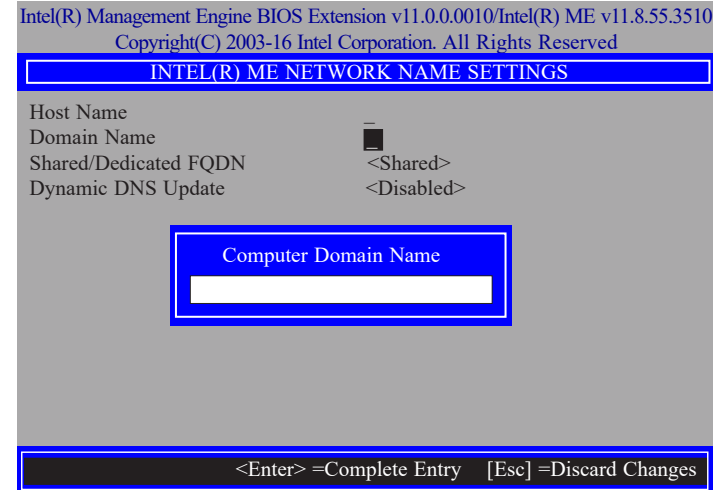

25. In the **Intel(R) ME Network Name Settings** menu, select **Host Name** then press Enter. Enter the computer's host name then press Enter.

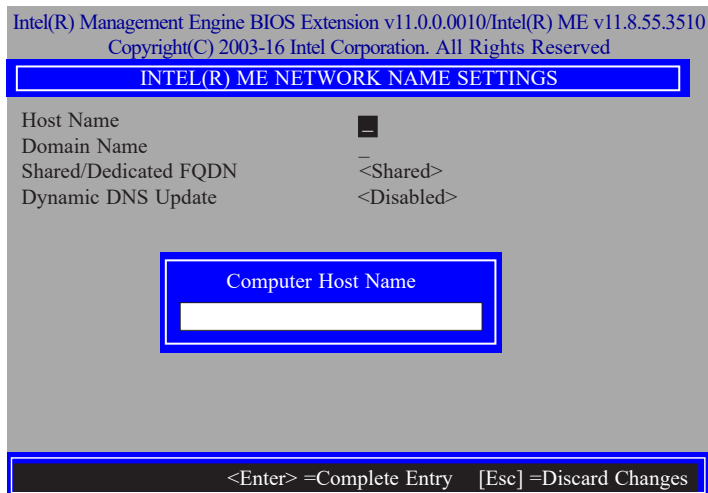

27. Select **Shared/Dedicated FQDN** then press Enter. Select **Shared** or **Dedicated** then press Enter.

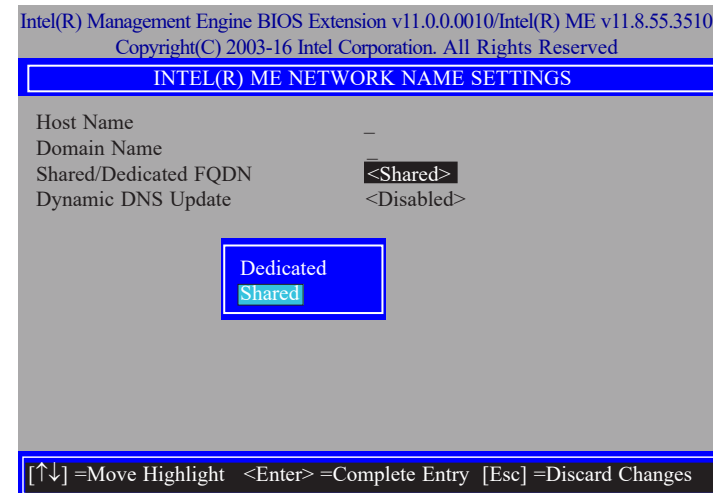

28. Select **Dynamic DNS Update** then press Enter. Select **Enabled** or **Disabled** then press Enter. If **Dynamic DNS Update** is set to **Enabled**, **Periodic Update Interval** and **TTL** fields will show up.

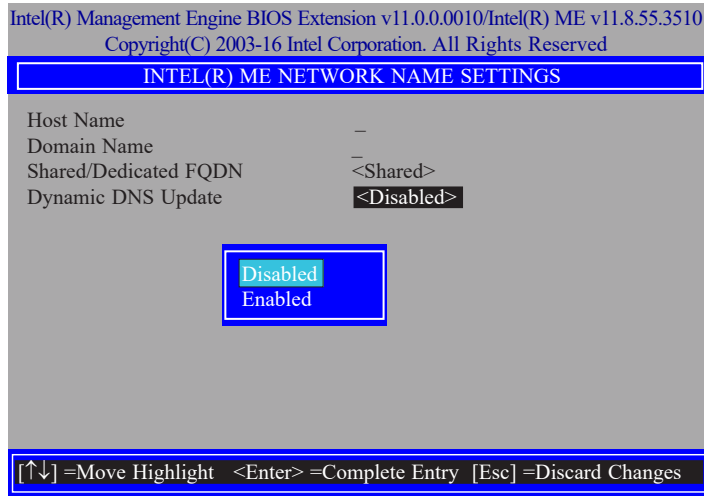

30. Select **TTL** then press Enter. Enter value then press Enter.

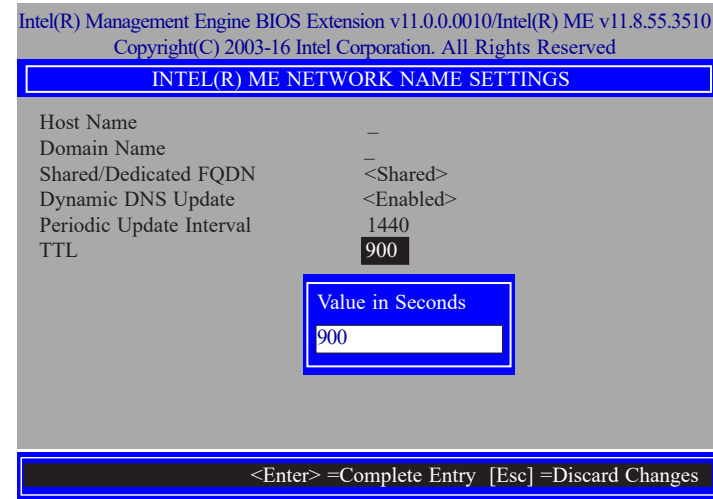

29. Select **Periodic Update Interval** then press Enter. Enter value then press Enter.

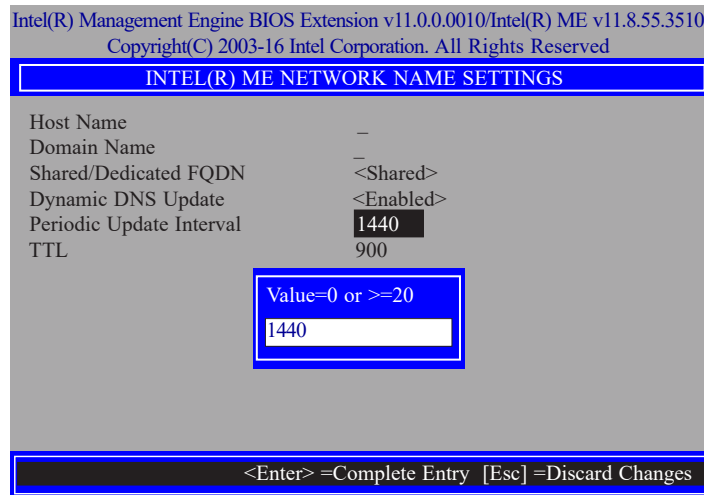

31. Press Esc until you return to the **Intel(R) ME Network Setup** menu. Select **TCP/IP Settings** then press Enter. In the **TCP/IP Settings** menu, select **Wired LAN IPv4 Configuration** then press Enter.

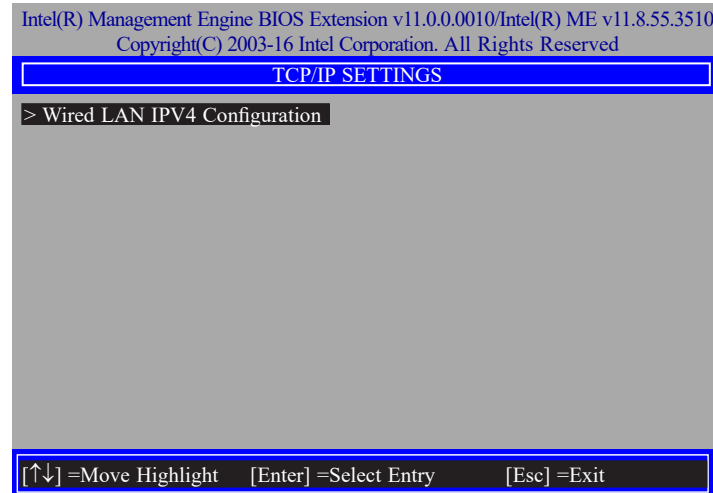

32. In the **Wired LAN IPv4 Configuration** menu, select **DHCP Mode** then press Enter. Select **Enabled** or **Disabled** then press Enter. If set to **Disabled**, **IPV4 Address**, **Subnet Mask Address**, **Default Gateway Address**, **Preferred DNS Address** and **Alternate DNS Address** will show up.

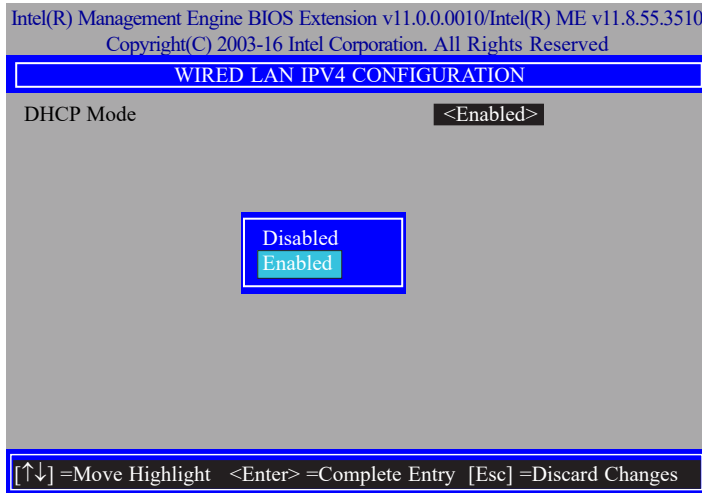

33. Select **IPV4 Address** then press Enter. Enter address then press Enter.

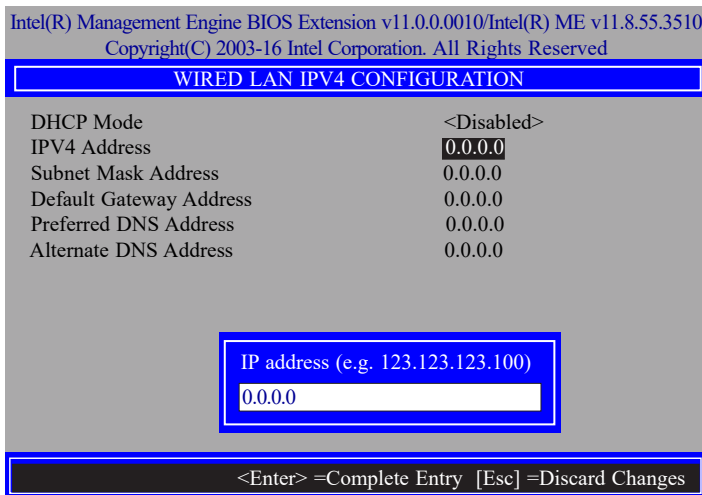

34. Select **Subnet Mask Address** then press Enter. Enter address then press Enter.

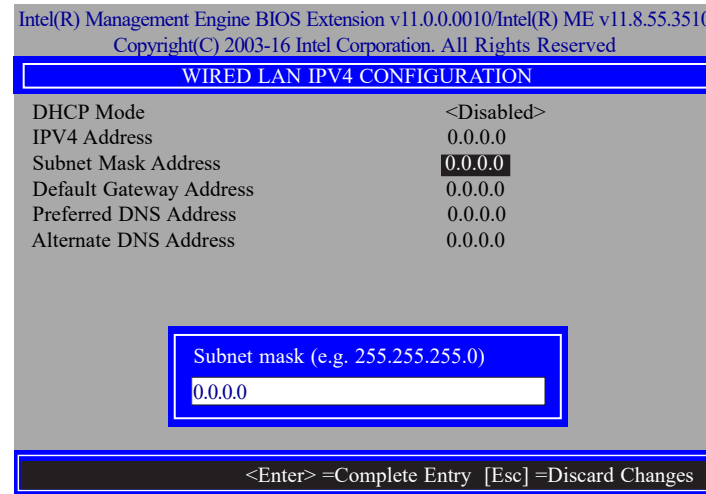

35. Select **Default Gateway Address** then press Enter. Enter address then press Enter.

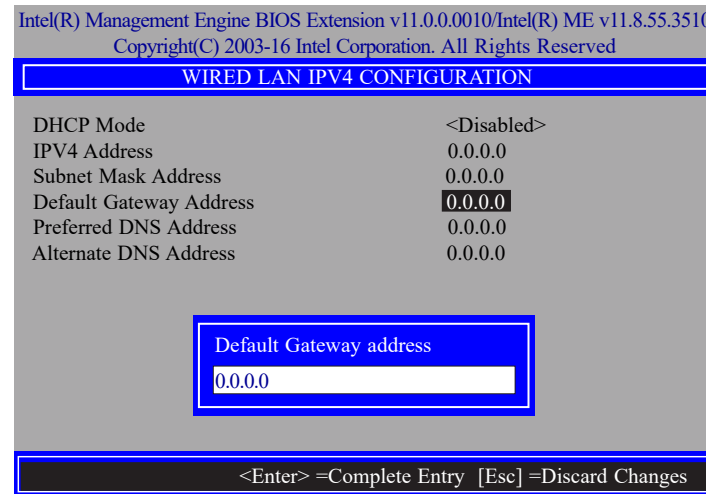

36. Select **Preferred DNS Address** then press Enter. Enter address then press Enter.

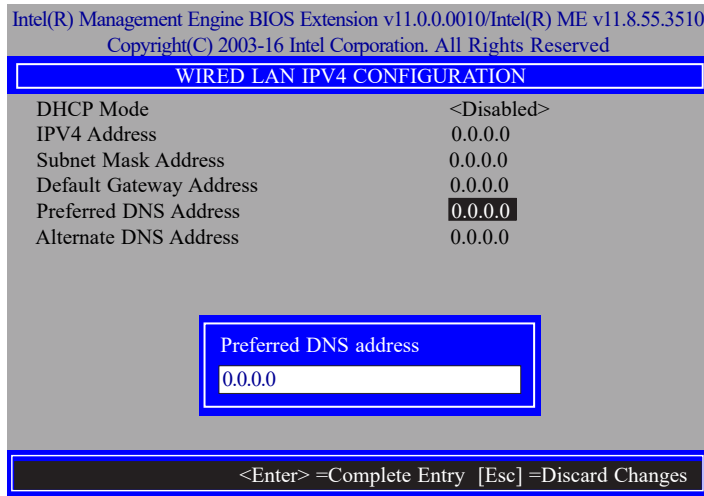

37. Select **Alternate DNS Address** then press Enter. Enter address then press Enter.

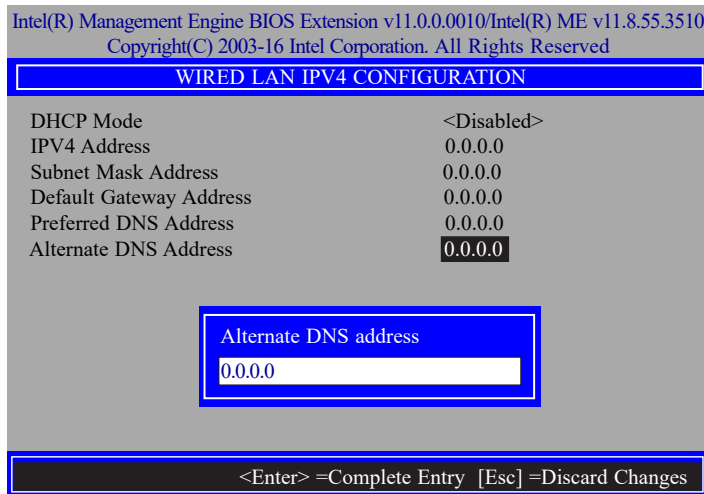

38. Press Esc until you return to the **Intel(R) AMT Configuration** menu. If you want to activate the current network settings and open the ME network interface, select **Activate Network Access**, press Enter, then press Y.

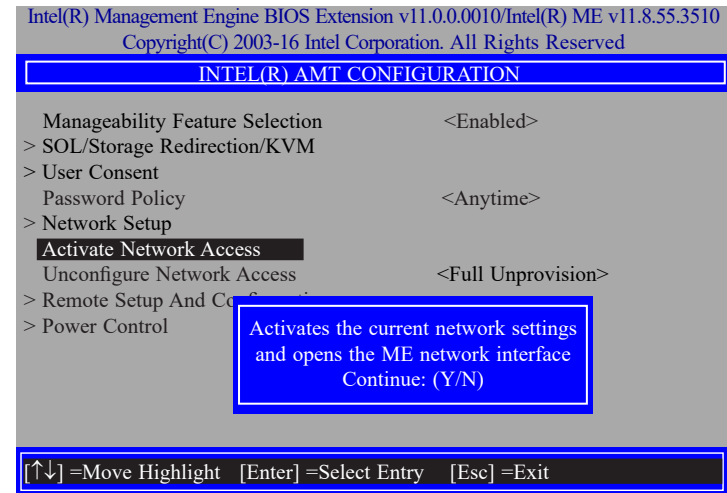

39. In the **Intel(R) AMT Configuration** menu, select **Unconfigure Network Access** then press Enter.

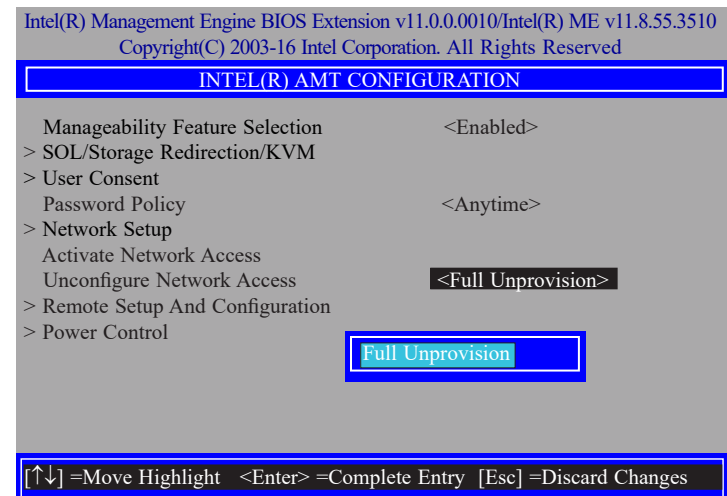

40. In the **Intel(R) AMT Configuration** menu, select **Remote Setup And Configuration** then press Enter.

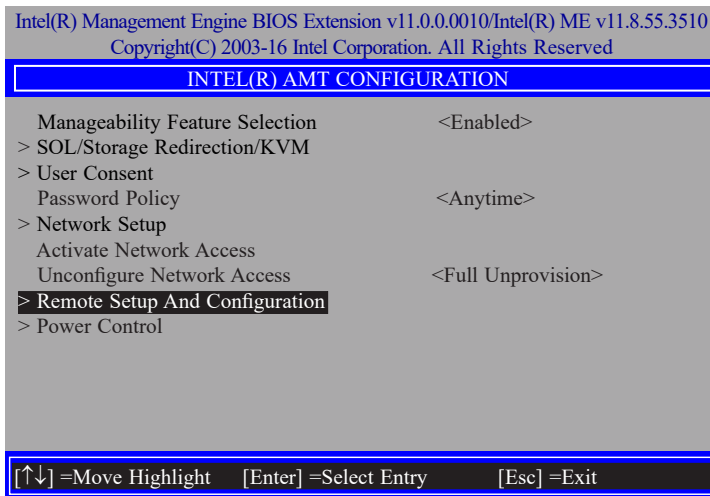

41. In the **Intel(R) Remote Setup And Configuration** menu, select **Current Provisioning Mode** then press Enter.

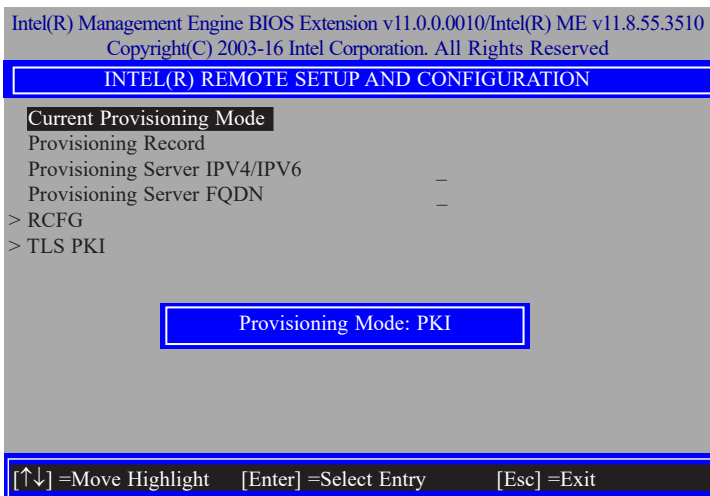

42. In the **Intel(R) Remote Setup And Configuration** menu, select **Provisioning Record** then press Enter.

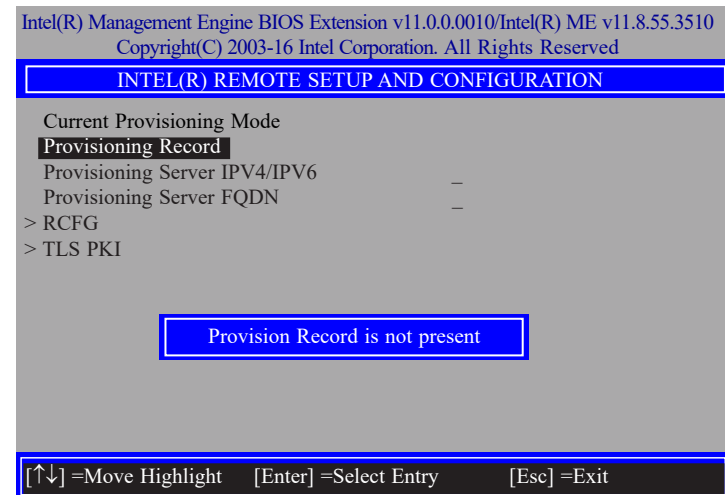

43. In the **Intel(R) Remote Setup And Configuration** menu, select **Provisioning Server IPV4/IPV6** then press Enter. Enter the address then press Enter.

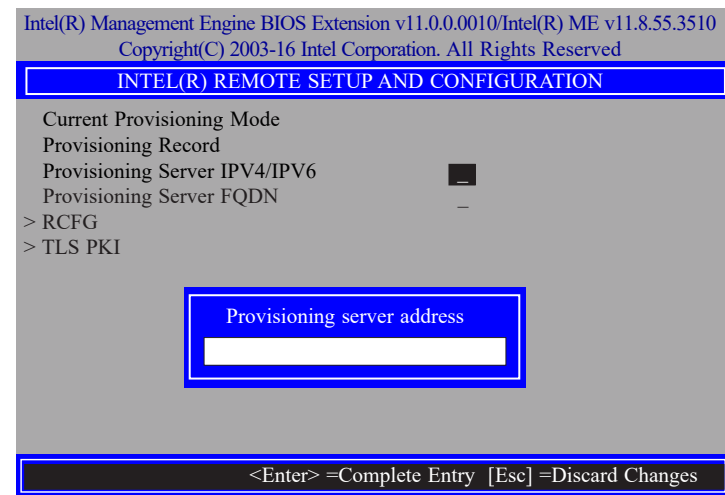

44. In the **Intel(R) Remote Setup And Configuration** menu, select **Provisioning Server FQDN** then press Enter. Enter the FQDN then press Enter.

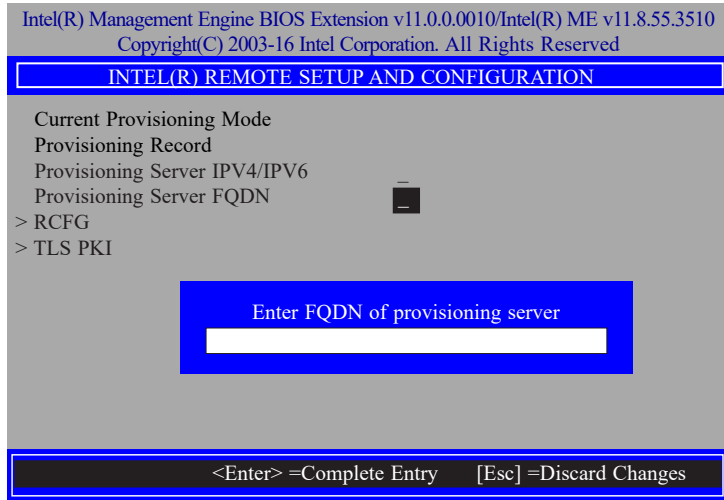

46. Press Esc until you return to the **Intel(R) Remote Setup And Configuration** menu. Select **TLS PKI** then press Enter. Select **Remote Configuration **** then press Enter. Select **Enabled** or **Disabled** then press Enter.

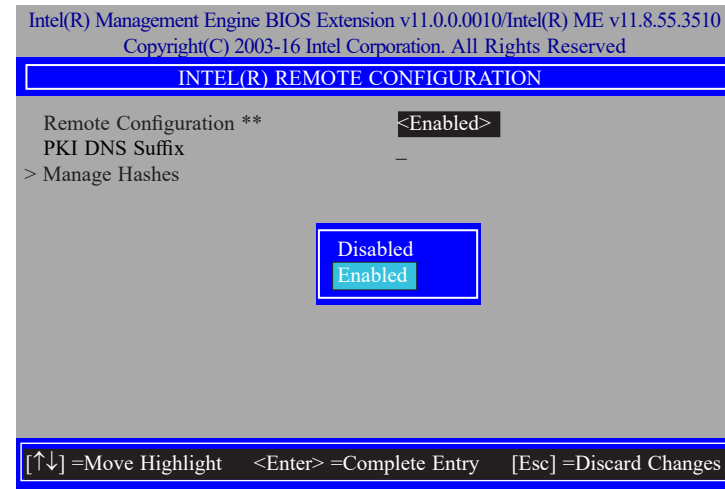

45. If you want to activate remote configuration, in the **Intel(R) Remote Setup And Configuration** menu, select **RCFG** then press Enter. Select **Start Configuration** then press Enter. Press **Y** to activate.

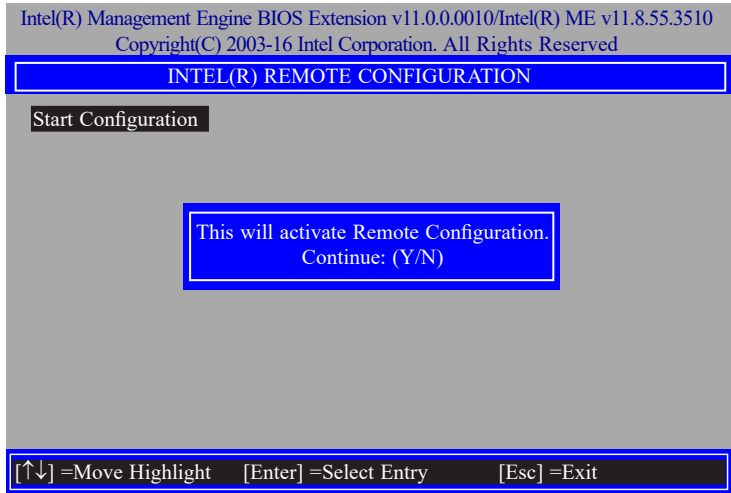

47. Select **PKI DNS Suffix** and press Enter. Enter the PKI DNS Suffix then press Enter.

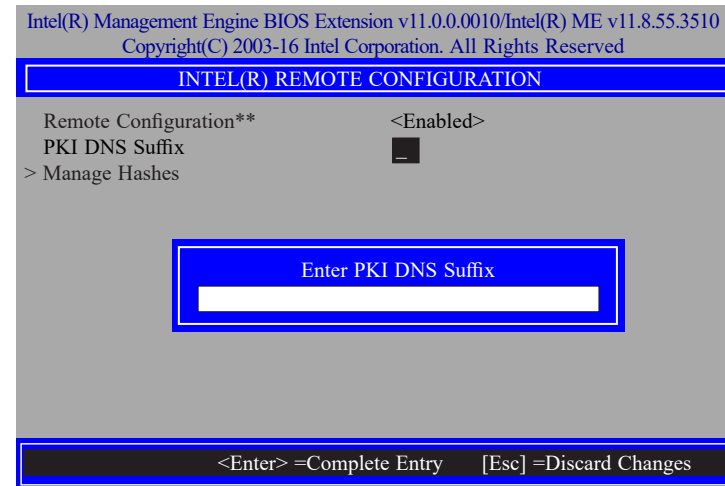

48. In the **Intel(R) Remote Configuration** menu, select **Manage Hashes** then press Enter. Select the hash name then press Insert to enter custom hash certificate name, press Delete to delete hash, press Enter to view hash information, press + to activate or deactivate hash, and press Esc to exit.

Intel(R) Management Engine BIOS Extension v11.0.0.0010/Intel(R) ME v11.8.55.3510
Copyright(C) 2003-16 Intel Corporation. All Rights Reserved

INTEL(R) REMOTE CONFIGURATION

Hash Name	Active	Default	Algorithm
VeriSign Class 3	Active: [*]	Default: [*]	SHA256
VeriSign Class 3	Active: [*]	Default: [*]	SHA256
Go Daddy Class 2	Active: [*]	Default: [*]	SHA256
Comodo AAA CA	Active: [*]	Default: [*]	SHA256
Starfield Class 2	Active: [*]	Default: [*]	SHA256
VeriSign Class 3	Active: [*]	Default: [*]	SHA256
VeriSign Class 3	Active: [*]	Default: [*]	SHA256
VeriSign Class 3	Active: [*]	Default: [*]	SHA256
GTE CyberTrust G1	Active: [*]	Default: [*]	SHA256
Baltimore CyberTr	Active: [*]	Default: [*]	SHA256
Cyber Trust Global	Active: [*]	Default: [*]	SHA256
Verizon Global Ro	Active: [*]	Default: [*]	SHA256
Entrust. net CA (2	Active: [*]	Default: [*]	SHA256
Entrust Root CA	Active: [*]	Default: [*]	SHA256
VeriSign Universa	Active: [*]	Default: [*]	SHA256
Go Daddy Root CA	Active: [*]	Default: [*]	SHA256
Entrust Root CA -	Active: [*]	Default: [*]	SHA256
Startfield Root CA	Active: [*]	Default: [*]	SHA256

[Ins] =Add New Hash [Delete] =Delete Hash [+] =Activate Hash
[↑↓] =Move Highlight [Enter] =View Hash [Esc] =Exit

49. Press Esc until you return to the **Intel(R) AMT Configuration** menu, select **Power Control** then press Enter. In the **Intel(R) AMT Power Control** menu, select **Intel(R) AMT ON in Host Sleep States** then press Enter. Select an option then press Enter.

Intel(R) Management Engine BIOS Extension v11.0.0.0010/Intel(R) ME v11.8.55.3510
Copyright(C) 2003-16 Intel Corporation. All Rights Reserved

INTEL(R) AMT POWER CONTROL

These configurations are effective only after AMT provisioning has started

Intel(R) AMT ON in Host Sleep States <Mobile: ON in S0, ME Wake in S3, S4-5 (AC only)>

Idle Timeout 65535

Mobile: ON in S0
Mobile: ON in S0, ME Wake in S3, S4-5 (AC only)

[↑↓] =Move Highlight <Enter> =Complete Entry [Esc] =Discard Changes

50. In the **Intel(R) AMT Power Control** menu, select **Idle Timeout** then press Enter. Enter the timeout value and press Enter.

Intel(R) Management Engine BIOS Extension v11.0.0.0010/Intel(R) ME v11.8.55.3510
Copyright(C) 2003-16 Intel Corporation. All Rights Reserved

INTEL(R) AMT POWER CONTROL

These configurations are effective only after AMT provisioning has started

Intel(R) AMT ON in Host Sleep States <Mobile: ON in S0, ME Wake in S3, S4-5>

Idle Timeout 65535

Timeout Value (1-65535)
65535

<Enter> =Complete Entry [Esc] =Discard Changes

51. Press Esc until you return to the **Main Menu**. Select **MEBx Exit** then press Enter. Press Y to exit.

Intel(R) Management Engine BIOS Extension v11.0.0.0010/Intel(R) ME v11.8.55.3510
Copyright(C) 2003-16 Intel Corporation. All Rights Reserved

MAIN MENU

> Intel(R) ME General Settings
> Intel(R) AMT Configuration
MEBx Exit

Are you sure you want to exit?(Y/N):

Exit

[↑↓] =Move Highlight [Enter] =Select Entry [Esc] =Exit