



DT122-BE

R-Series



Features

- Supports DDR3/DDR3L SODIMM up to 16GB
- Up to 2x 2.5" or 1x 3.5" SATA drive bay
- 4 independent displays



Panel

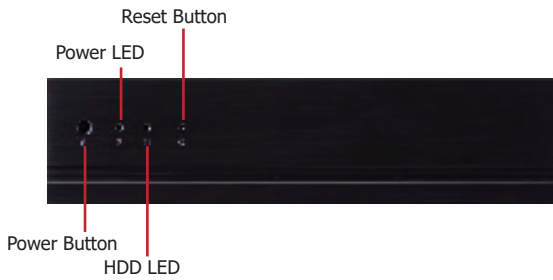

Front View

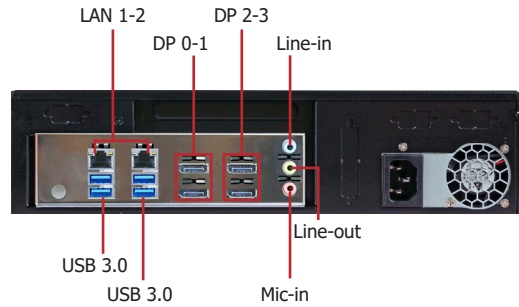

Rear View

Dimensions

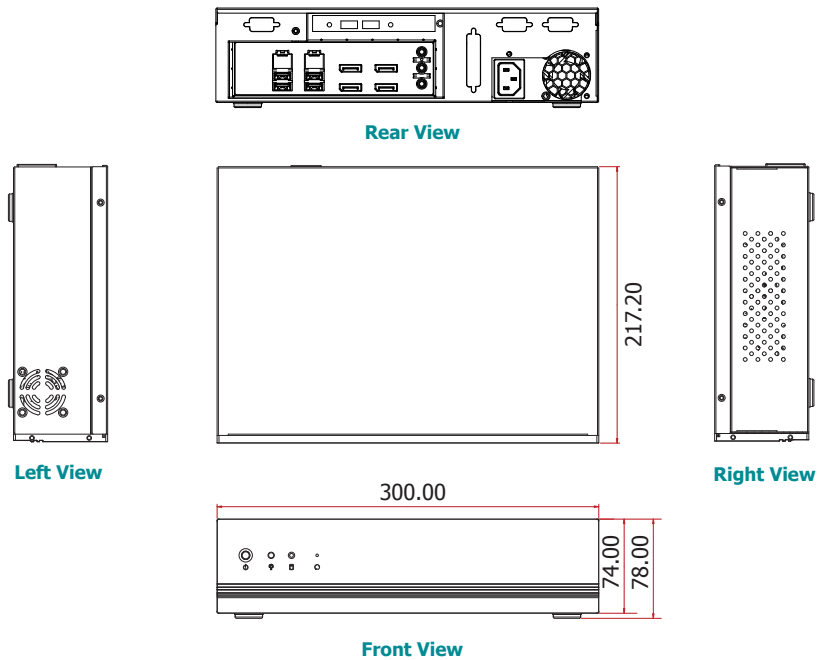

DT122-BE

Specifications * Optional and is not supported in standard model. Please contact your sales representative for more information.

PROCESSOR SYSTEM

- CPU
 - 2nd Generation AMD® Embedded R-Series APU FP3 BGA (28nm process technology)
: AMD® RX-427BB, Quad Core, 4M Cache, 2.7GHz (3.6GHz), 35W
- Chipset: AMD® A77E Fusion Controller Hub

MEMORY

- Two 204-pin SODIMM sockets
- Supports DDR3/DDR3L 1600/1866/2133MHz
- Supports up to 16GB system memory
- Supports dual channel memory interface

GRAPHICS

- AMD Radeon™ HD 9000 Series Graphics
- Display ports: 4 DP (supports DP++)
- DP: resolution up to 3840x2160 @ 30Hz

STORAGE

- Up to 2x 2.5" or 1x 3.5" SATA drive bay
 - SATA 3.0 port with data transfer rate up to 6Gb/s

ETHERNET

- 1 Intel® I210 PCI Express Gigabit Ethernet controller
- 1 Realtek RTL8111EP Ethernet controller
- Integrated 10/100/1000 transceiver
- Fully compliant with IEEE 802.3, IEEE 802.3u, IEEE 802.3ab

EXPANSION

- 1 expansion slot
 - 1 PCIe x16
- 1 Mini PCIe slot
 - Supports USB and PCIe signals
 - Supports mSATA
 - Supports half size or full size Mini PCIe card

AUDIO

- Realtek ALC888 7.1-channel High Definition Audio

I/O PORTS

- Front Panel
 - 1 Power button
 - 1 Reset button
 - 2 LED indicators: Power, HDD
- Rear Panel
 - 4 USB 3.0
 - 4 DP
 - 2 RJ45 LAN
 - Mic-in, line-in and line-out jacks

POWER

- Power type
 - Flex ATX
- Power input voltage
 - AC 100-240V, 250W

COOLING SYSTEM

- 1 system fan

ENVIRONMENT

- Temperature
 - Operating: 0°C~45°C
 - Storage: -20°C~60°C
- Humidity
 - 85% RH at 45°C, 1 week
- Operating Vibration
 - Operating: sine 5~500Hz, 1G
 - Non-operating: sine 10~500Hz, 3G
- Operating Shock
 - Operating: 3G
 - Non-operating: 5G

CONSTRUCTION

- Front panel: aluminum
- Rear chassis: sheet metal

MOUNTING

- 2 types of wall mount bracket
 - Type A
 - Type B

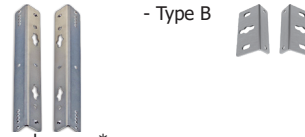

- Brackets and screws*

DIMENSIONS

- 300mm x 75mm x 217mm (W x H x D)

WEIGHT

- 3.7 kg

OS SUPPORT

- Windows 7 Ultimate x86 & SP1 (32-bit)
- Windows 7 Ultimate x64 & SP1 (64-bit)
- Windows 8.1 Embedded Pro x64 (64-bit)

OTHER FEATURES

- Watchdog Timer function

CERTIFICATION

- CE
- FCC Class A
- RoHS



DT122-BE

Wall Mounting

Type A Wall mount bracket

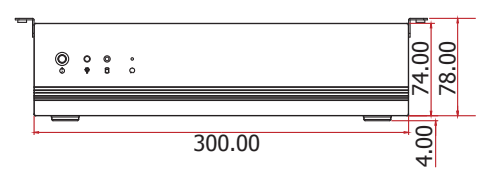
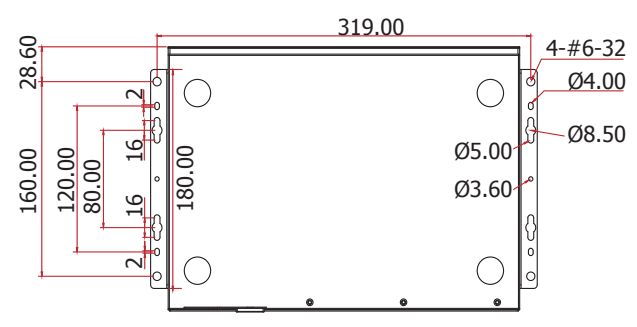
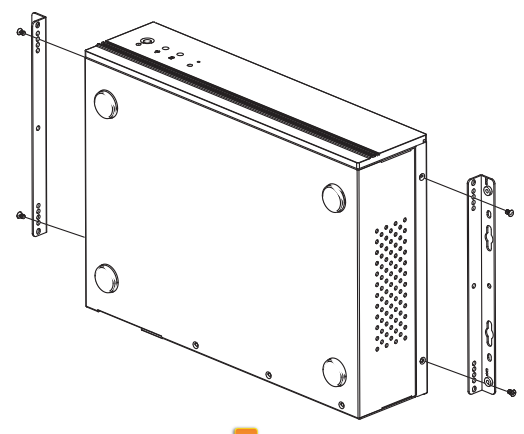

Type B Wall mount bracket

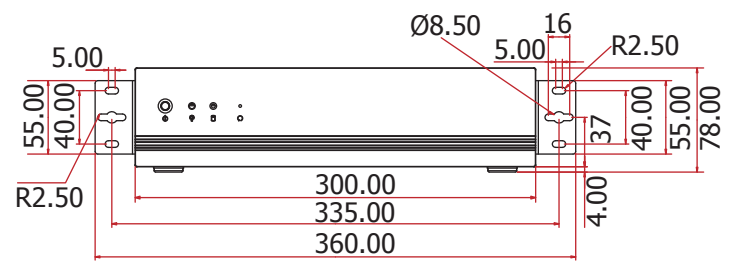
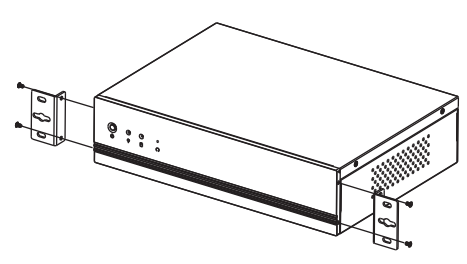

DT122-BE

► Ordering Information

Model Name	Part Number	Description
DT122-BE	750-DT1220-800G	DT122-BE: BE170 RoHS, 1 PCIe x16

► Optional Items

Optional Items	Part Number	Description
Memory	785-RSOD38G-L	SODIMM, DDR3L Module (supports dual voltage 1.5V DDR3/1.35V DDR3L), 8GB, RoHS
	785-RSOD34G-L	SODIMM, DDR3L Module (supports dual voltage 1.5V DDR3/1.35V DDR3L), 4GB, RoHS
	785-RSOD32G-L	SODIMM, DDR3L Module (supports dual voltage 1.5V DDR3/1.35V DDR3L), 2GB, RoHS
	785-RSOD31G	SODIMM, DDR3 Module, 1GB, RoHS
HDD	785-H353T0B	3.5" SATA HDD, 500GB, RoHS
	785-H25500G	2.5" SATA HDD, 500GB, RoHS
	785-H25320G	2.5" SATA HDD, 320GB, RoHS
	785-S251TBG	2.5" SATA SSD, 1TB MLC, RoHS
	785-S25512G	2.5" SATA SSD, 512GB MLC, RoHS
	785-S25256G	2.5" SATA SSD, 256GB MLC, RoHS
	785-S25128G	2.5" SATA SSD, 128GB MLC, RoHS
	785-S25064G	2.5" SATA SSD, 64GB MLC, RoHS
mSATA	785-MS128GMF	mSATA Card, 128GB MLC, RoHS
	785-MS64GMF	mSATA Card, 64GB MLC, RoHS
	785-MS32GMF	mSATA Card, 32GB MLC, RoHS
	785-MS16GMF	mSATA Card, 16GB MLC, RoHS
	785-MS08GMF	mSATA Card, 8GB MLC, RoHS
	785-MS04GMF	mSATA Card, 4GB MLC, RoHS
Wi-Fi	761-110091-000G	Wi-Fi Kit, RoHS
Power Cord	785-PWRD	Power Cord, Standards (USA/EUR/CH), 1.8m, RoHS
Wall Mount	761-DT1220-100G	DT122 Type A Wall Mount Kit for Top Cover, RoHS
	761-DT1220-000G	DT122 Type B Wall Mount Kit for Front Cover, RoHS

► Packing List

• 1 DT122-BE system unit
• 1 CPU cooler
• 1 HDD drive bay kit
• 1 Quick Installation Guide