

# WL9A3

ULT

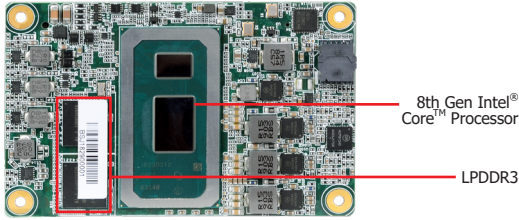

TOP

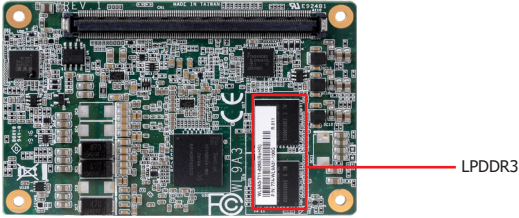

BOTTOM

## Features

- Dual Channel LPDDR3 2133MHz Memory Down up to 16GB
- 1 LVDS/eDP, 1 DDI (HDMI/DP)  
Supports dual displays: DDI + LVDS/eDP
- DP++ resolution supports up to 4096x2304 @ 60Hz
- Multiple expansions: 4 PCIe x1
- Rich I/O: 1 Intel GbE, 2 USB 3.0, 8 USB 2.0



## Mechanical Drawing

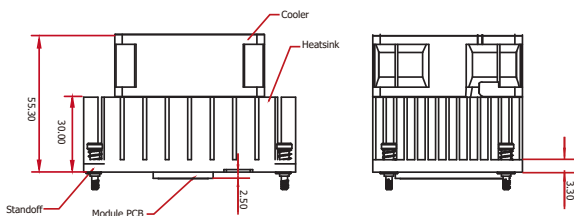
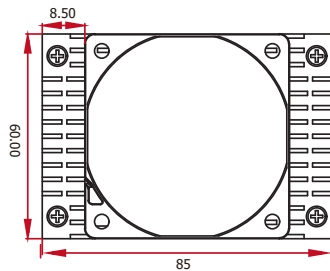
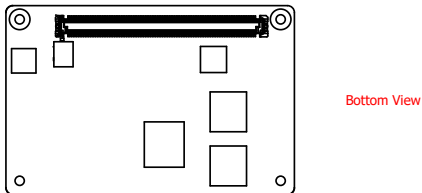
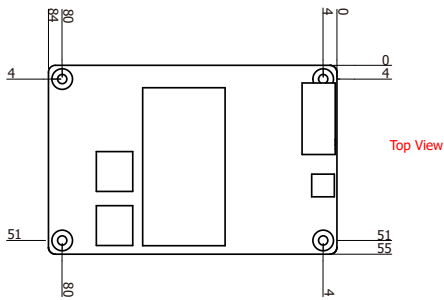

## Block Diagram

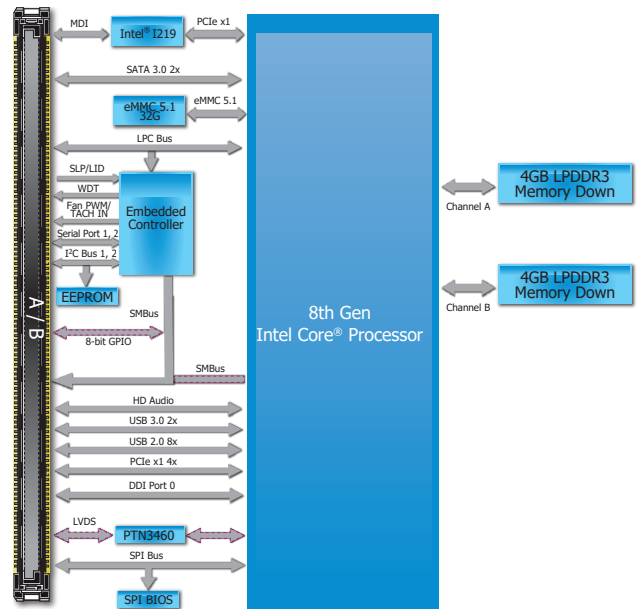

## ► Specifications

<b>SYSTEM</b>	<b>Processor</b>	8th Gen Intel® Core™ Processor, FCBGA1528 Intel® Core™ i7-8665UE Processor, Quad Core, 8M Cache, 1.7GHz (4.4GHz), 15W Intel® Core™ i5-8365UE Processor, Quad Core, 6M Cache, 1.6GHz (4.1GHz), 15W Intel® Core™ i3-8145UE Processor, Dual Core, 4M Cache, 2.1GHz (3.9GHz), 15W	
	<b>Memory</b>	8GB/16GB Memory Down Dual Channel LPDDR3 2133MHz	
	<b>BIOS</b>	SPI 128Mbit (default supports FTPM)	
<b>GRAPHICS</b>	<b>Controller</b>	Intel® UHD Graphics 620	
	<b>Feature</b>	OpenGL 5.0, DirectX 12, OpenCL 2.1 HW Decode: AVC/H.264, MPEG2, VC1, WMV9, JPEG/MJPEG, HEVC/H.265, VP8, VP9, MVC HW Encode: AVC/H.264, JPEG/MJPEG, HEVC/H.265, VP8, VP9, MVC	
	<b>Display</b>	1 x DDI (HDMI/DP++) 1 x LVDS/eDP	LVDS: single channel 24-bit, resolution up to 1366x768 @ 60Hz HDMI: resolution up to 4096x2160 @ 30 Hz DP++: resolution up to 4096x2304 @ 60Hz eDP: resolution up to 4096x2304 @ 60Hz
	<b>Dual Display</b>	DDI + LVDS	DDI + eDP
<b>EXPANSION</b>	<b>Interface</b>	4 x PCIe x1 (Gen 3) 1 x SDIO 1 x LPC 2 x I <sup>2</sup> C 1 x SMBus 1 x SPI 2 x UART (TX/RX)	
<b>AUDIO</b>	<b>Interface</b>	HD Audio	
<b>ETHERNET</b>	<b>Controller</b>	1 x Intel® I219 (10/100/1000Mbps)	
<b>I/O</b>	<b>USB</b>	2 x USB 3.0 8 x USB 2.0	
	<b>SATA</b>	2 x SATA 3.0 (up to 6Gb/s)	
	<b>GPIO</b>	1 x 8-bit GPIO	
<b>WATCHDOG TIMER</b>	<b>Output &amp; Interval</b>	System Reset, Programmable via Software from 1 to 255 Seconds	
<b>POWER</b>	<b>Type</b>	12V~20V, 5VSB, VCC_RTC (ATX mode)	12V~20V, VCC_RTC (AT mode)
	<b>Consumption</b>	TBD	
<b>OS SUPPORT (UEFI ONLY)</b>		Windows 10 IoT Enterprise 64-bit	Linux
<b>ENVIRONMENT</b>	<b>Temperature</b>	Operating: 0 to 60°C -40 to 85°C	Storage: -40 to 85°C
	<b>Humidity</b>	Operating: 5 to 90% RH	Storage: 5 to 90% RH
	<b>MTBF</b>	TBD	
<b>MECHANICAL</b>	<b>Dimensions</b>	COM Express® Mini	84mm (3.30") x 55mm (2.16")
	<b>Compliance</b>	PICMG COM Express® R3.0, Type 10	

## ► Ordering Information

Model Name	P/N	Processor	Memory	eMMC	DIO/SDIO	LVDS/eDP	GbE	USB 3.0	USB 2.0	Power	Temp.
<b>WL9A3-T80-8665</b>	770-WL9A31-000G	i7-8665UE	LPDDR3 8 GB	NA	DIO	LVDS	1	2	8	ATX/AT	-40~85°C
<b>WL9A3-T80-8365</b>	770-WL9A31-100G	i5-8365UE	LPDDR3 8 GB	NA	DIO	LVDS	1	2	8	ATX/AT	-40~85°C
<b>WL9A3-B80-8145</b>	770-WL9A31-200G	i3-8145UE	LPDDR3 8 GB	NA	DIO	LVDS	1	2	8	ATX/AT	-5~65°C
<b>WL9A3-T10-8665</b>	770-WL9A31-300G	i7-8665UE	LPDDR3 16 GB	NA	DIO	LVDS	1	2	8	ATX/AT	-30~85°C

## ► Packing List

• 1 WL9A3 board	
• 1 Heat sink (for 0 to 60°C)	A71-008129-000G
• 1 Cooler (for -40 to 85°C)	A71-108120-000G

## ► Optional Items

• COM100-B carrier board kit	770-COM104-000G
• Heat spreader	A71-808320-000G