

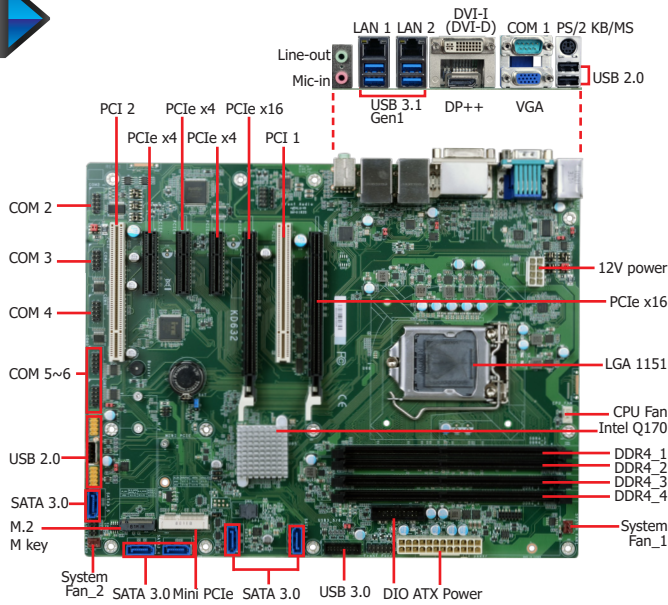

KD632-Q170

Desktop

Q170



Features

- 4 DDR4 Non-ECC U-DIMM up to 64GB
- 3 independent displays: VGA + DVI-I (DVI-D signal) + DP++
- DP++ resolution up to 4096x2160 @ 60Hz
- Multiple expansion: 2 PCIe x16 (1 x16 or 2 x8 signal), 3 PCIe x4, 2 PCI, 1 M.2 M key, 1 Mini PCIe
- Rich I/O: 2 Intel GbE, 6 COM, 6 USB 3.1 Gen1, 7 USB 2.0



2 Extension Modules for Additional 4 COM Ports (via the LPC connector)

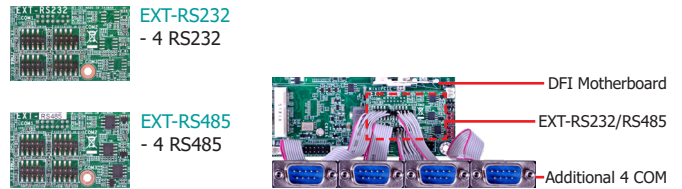

Ordering Information

Model Name	P/N	Memory	GbE	RS-232/422/485	RS-232	USB 3.1 Gen1	USB 2.0	Power	Thermal	Temp.
KD632-Q170CRM	770-KD6321-000G	4 U-DIMM	2	2	4	6	7	24-pin ATX	Active	0 to 60°C

Mechanical Drawing

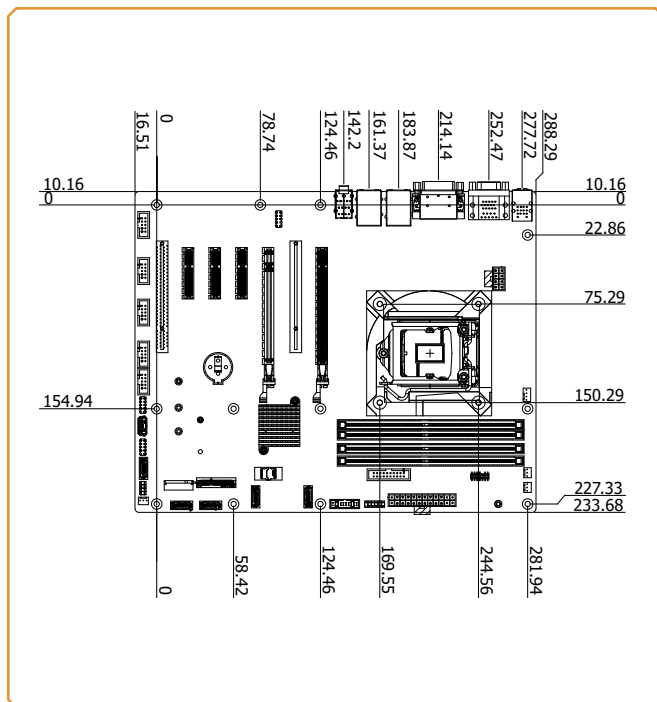

Block Diagram

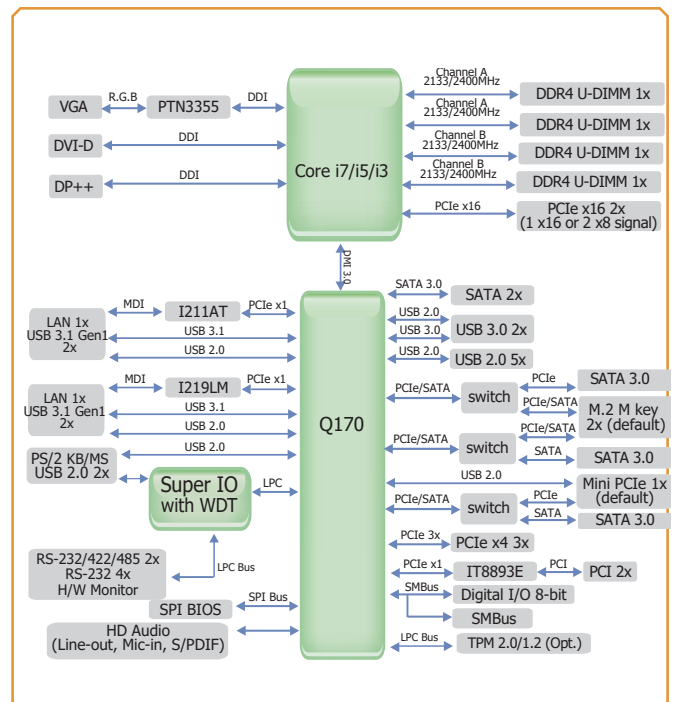

Specifications

SYSTEM	Processor	6th/7th Generation Intel® Core™ /Pentium®/Celeron® LGA 1151 Socket Processors with TDP up to 95W		
	Chipset	Intel® Q170 Chipset		
	Memory	Four 288-pin Non-ECC U-DIMM up to 64GB	Dual Channel DDR4 2133/2400MHz	
	BIOS	Insyde SPI 128Mbit		
GRAPHICS	Controller	Intel® HD Gen 9 Graphics		
	Feature	OpenGL 5.0, DirectX 12, OpenCL 2.1 HW Decode: AVC/H.264, MPEG2, VC1/WMV9, JPEG/MJPEG, HEVC/H265, VP8, VP9 HW Encode: MPEG2, AVC/H264, JPEG, HEVC/H265, VP8, VP9		
	Display	1 x VGA 1 x DVI-I (DVI-D signal) 1 x DP++	VGA: resolution up to 1920x1200 @ 60Hz DVI-D: resolution up to 1920x1200 @ 60Hz DP++: resolution up to 4096x2160 @ 60Hz	
	Triple Displays	VGA + DVI-I (DVI-D signal) + DP++		
EXPANSION	Interface	2 x PCIe x16 (1 x16 or 2 x8 signal) (Gen 3) 3 x PCIe x4 (Gen 3) 2 x PCI 1 x M.2 2260/2280 M key (SATA3.0/PCIe Gen3 x 2 NVMe) 1 x Mini PCIe (PCIe/mSATA/USB 2.0)		
AUDIO	Audio Codec	Realtek ALC888S-VD2-GR		
ETHERNET	Controller	1 x Intel® I211AT PCIe (10/100/1000Mbps) 1 x Intel® I219LM PCIe with iAMT11.0 (10/100/1000Mbps) (only Core i7/i5 supports iAMT)		
REAR I/O	Ethernet	2 x GbE (RJ-45)		
	USB	4 x USB 3.1 Gen1 2 x USB 2.0		
	Serial	1 x RS-232/422/485 (RS-232 w/ power) (DB-9)		
	PS/2	1 x PS/2 (mini-DIN-6)		
	Display	1 x VGA 1 x DVI-I (DVI-D signal) 1 x DP++		
	Audio	1 x Line-out, 1 x Mic-in, 1 x Line-in (opt., MOQ required)		
	INTERNAL I/O	Serial	1 x RS-232/422/485 (RS-232 w/ power) (2.54mm pitch) 4 x RS-232 (2.54mm pitch)	
USB		2 x USB 3.1 Gen1 4 x USB 2.0 + 1 x Vertical USB 2.0 (type A)		
Audio		1 x Front Audio Header 1 x S/PDIF		
SATA		5 x SATA 3.0 (up to 6Gb/s) (1 SATA shared with mini PCIe (SATA), default at mini PCIe/2 SATA shared with M.2, default at M.2) RAID 0/1/5/10		
DIO		1 x 8-bit DIO		
LPC		1 x LPC (supports LPC EXT-RS232/RS485 module)		
SMBus		1 x SMBus		
WATCHDOG TIMER		Output & Interval	System Reset, Programmable via Software from 1 to 255 Seconds	
SECURITY		TPM	Infineon TPM1.2/2.0 (opt., MOQ required)	
POWER		Type	ATX	
	Connector	8-pin ATX 12V power	24-pin ATX power	
	Consumption	Idle: i7-7700 65W: 12V @ 0.29A (3.48W), 5V @ 0.47A (2.35W), 3.3V @ 0.32A 1.056W) Max: i7-7700 65W: 12V @ 7.86A (94.32W), 5V @ 1.43A (7.15W), 3.3V @ 0.36A (1.188W)		
	RTC Battery	CR2032 Coin Cell		
	OS SUPPORT	Windows 7 32/64-bit Windows 8.1 64-bit Windows 10 64-bit Linux Note: 7th Gen CPU SKU ONLY support Windows 10 64-bit & Linux.		
ENVIRONMENT	Temperature	Operating: 0 to 60°C Storage: -30 to 60°C with RTC Battery; -40 to 85°C without RTC Battery		
	Humidity	Operating: 5 to 90% RH Storage: 5 to 90% RH		
	MTBF	537,588 hrs @ 25°C; 298,813 hrs @ 45°C; 184,762 hrs @ 60°C Calculation model: Telcordia Issue 4 Environment: GB, GC – Ground Benign, Controlled		
MECHANICAL	Dimensions	ATX Form Factor	305mm (12") x 244mm (9.6")	
	Height	PCB: 1.6mm	Top Side: 37.35mm Bottom Side: 4.4mm	
CERTIFICATIONS	CE, FCC Class B, RoHS			

Packing List

• 1 KD632-Q170 motherboard	
• 1 COM port cables (Length: 400mm, 2 x COM ports)	A81-015026-023G
• 1 Serial ATA data cable (Length: 500mm)	332-553001-005G
• 1 I/O shield	A49-KD6000-000G
• 1 M.2 standoff	A33-725019-090G
• 1 M.2 screw	A32-112016-041G

Optional Items

• USB 2.0 port cable (Length: 350mm)	A81-001066-016G
• USB 3.1 Gen1 port cable (Length: 320mm)	A81-001052-023G
• Front Audio cable	A81-022022-016G
• DP to HDMI dongle	612-D2H13M-000G
• COM port cable (Length: 300mm, 2 x COM ports)	A81-015026-023G
• Serial ATA data cable (Length: 500mm, W/LOCK)	332-553001-005G
• Thermal solution (For 35W, Height: 37.3mm)	A71-103004-000G
• Thermal solution (For 65W, Height: 74.47mm)	A71-101158-000G
• Thermal solution (For 95W, Height: 77.2mm)	761-103001-000G
• LPC EXT-RS232 module (4 x RS232 ports)	770-EXTRS1-000G
• LPC EXT-RS485 module (4 x RS485 ports)	770-EXTRS1-100G