

# DFI®

## VC230-AL Installation Guide



### Package Contents

- 1 VC230-AL system unit
- Mounting screws for Mini PCIe modules and SATA drive installation
- 1 Quick Installation Guide

DFI reserves the right to change the specifications at any time prior to the product's release. For the latest revision and details of the installation process, please refer to the user's manual.

Front View

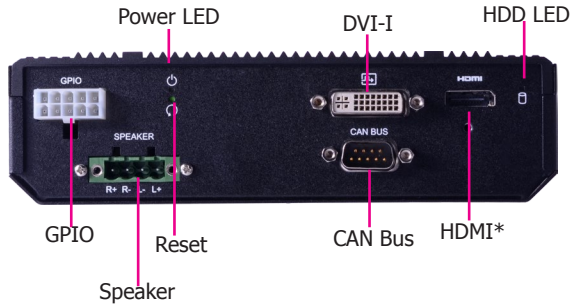

Rear View

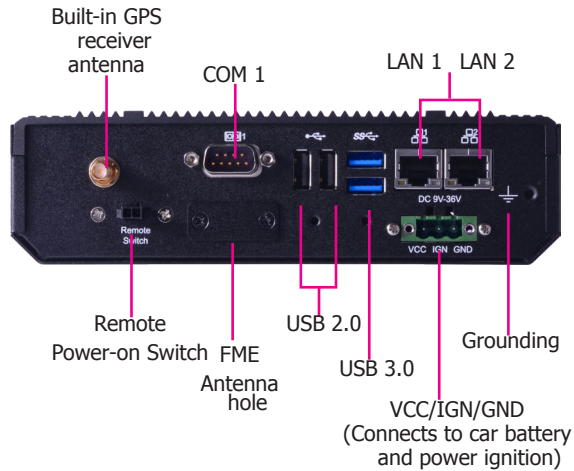

**Note:**

The HDMI is a DP/HDMI combo port but can only transmit HDMI signals. Please plug in an HDMI cable with the right orientation and alignment to avoid damage to the connector. Please see a video at <https://youtu.be/SUj07rfN5I8> for detailed instructions.



## Removing the Chassis Cover

Please observe the following guidelines and follow the procedure to open the system.

1. Make sure the system and all other peripheral devices connected to it have been powered off.
2. Disconnect all power cords and cables.
3. The 14 mounting screws on the bottom and two sides of the system are used to secure the cover to the chassis. Remove these screws and then put them in a safe place for later use.

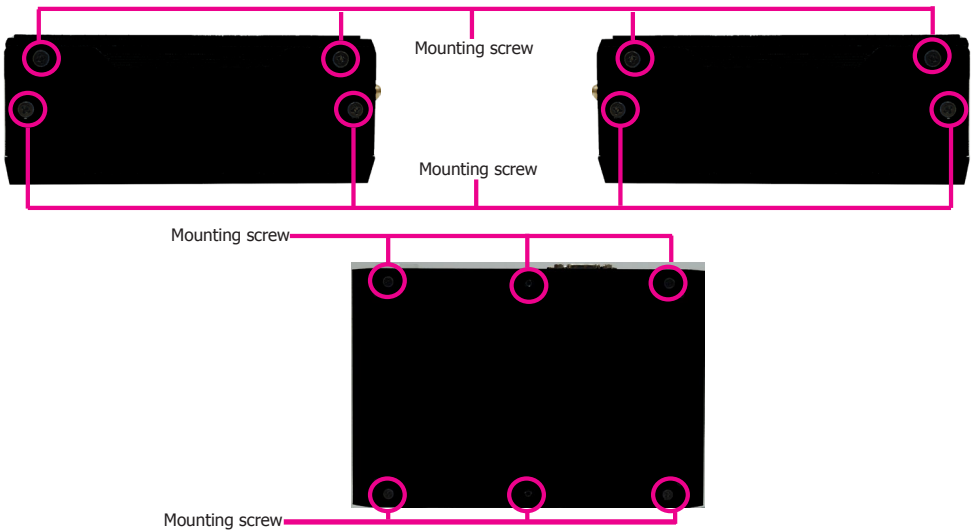

4. After removing the mounting screws, lift the chassis cover to open the system. To access the SODIMM and Mini PCIe and SIM card slots, remove the four screws to uninstall the power board.

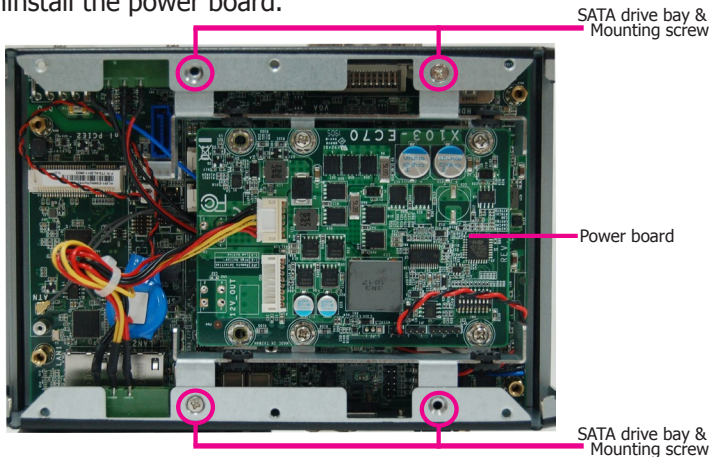

## Installing a SODIMM

The system supports one DDR3L-1600/1866 up to 8GB. To install a memory module, grasp the memory module by its edges and align the module's notch with the socket's notch; then insert the memory into the socket at an angle and push it down until you feel a click.

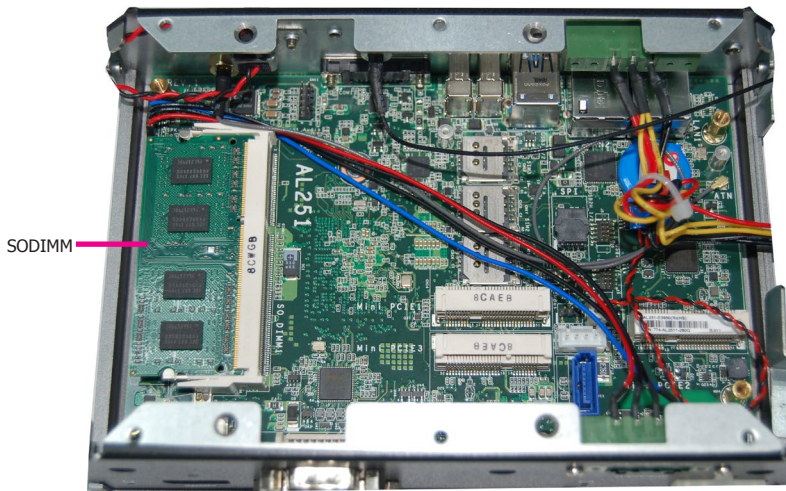

### **Note:**

The SODIMM socket can only accept DDR3L memory modules.

## Installing a Mini PCIe Card

The system board is equipped with 3 Mini PCIe slots: two full-size (Mini PCIe1: support for dual micro SIM sockets 1& 2 ; Mini PCIe2: support for micro SIM socket 3) and one half-size slots. Here we will demonstrate the installation of a full-size Mini PCIe card (mSATA interface) for capacity expansion.

To install a Mini PCIe card:

Grasp the Mini PCIe card by its edges and align the notch in the connector of the PCIe card with the notch in the connector on the system board. Push the Mini PCIe card down and use the provided mounting screws to secure the card on the system board.



Install the card at an angle

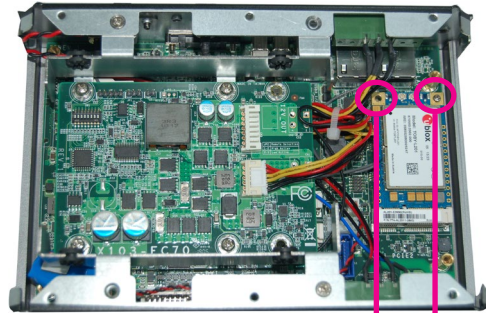

Mini PCIe card

## Installing a SIM Card

Open the SIM card socket by pushing the white latch inward. Slide the card holder left to open it. Place the card with the IC facing down and the angled corner aligning with the socket's angled corner so it will be correctly in contact with the system board.

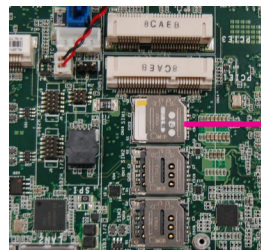
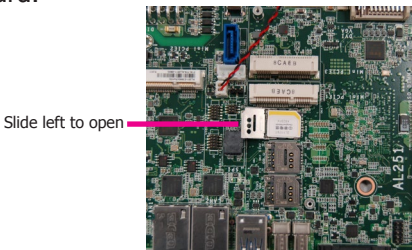

Slide right to close



### Note:

The system also has one additional full-size Mini PCIe and one half-size Mini PCIe slot that use PCIe (PCIe/USB signals) and mSATA (SATA signals) interface respectively.

## Installing a SATA Drive

The system supports one SATA drive. To install a SATA drive, uninstall the SATA mount bracket from the system.

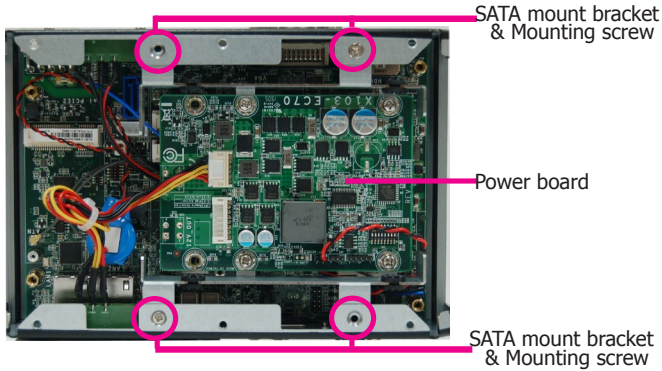

Install the SATA on the SATA mount bracket and place the installed SATA drive back in the system and secure it with 4 mounting screws.

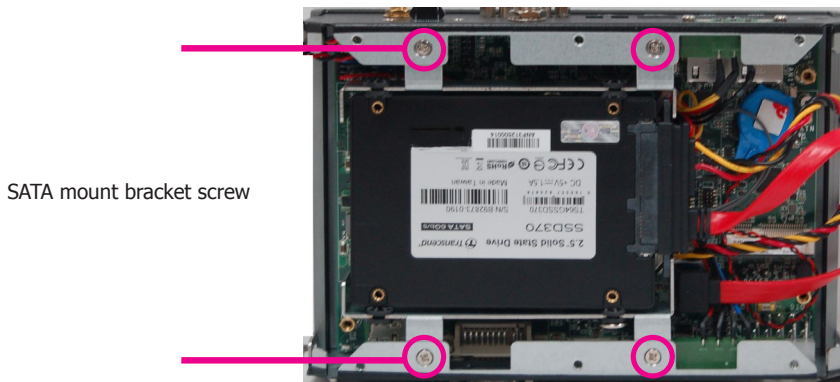



# Board Layout and Connector Pin Assignments

## System Board

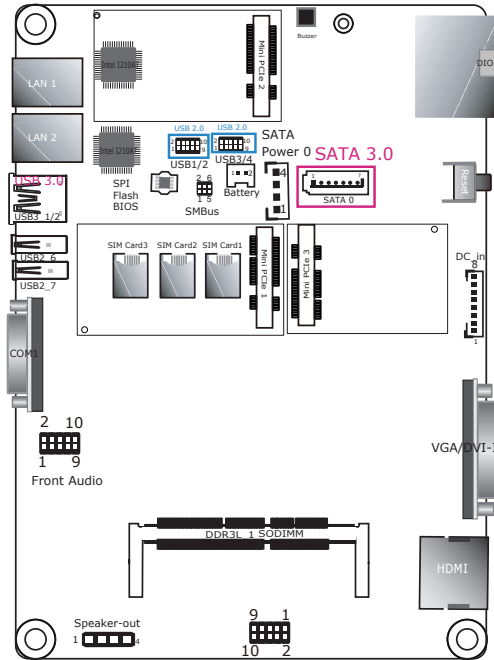

### Front Audio

|   |            |    |         |
|---|------------|----|---------|
| 1 | Mic_L      | 2  | Ground  |
| 3 | Mic_R      | 4  | NC      |
| 5 | Line_Out_R | 6  | MIC_JD  |
| 7 | GND        | 8  | NC      |
| 9 | Line_Out_L | 10 | LINE_JD |

### Speaker-OUT Connector (J4)

|   |    |   |    |
|---|----|---|----|
| 1 | L+ | 2 | L- |
| 3 | R- | 4 | R+ |

### DC-in Connector (J12)

|   |           |   |         |
|---|-----------|---|---------|
| 1 | Ground    | 2 | Ground  |
| 3 | Power Off | 4 | UART_TX |
| 5 | UART_RX   | 6 | 12V     |
| 7 | 12V       | 8 | 12V     |

### USB 2.0 1/2 (J5), 3/4 (J6)

|   |        |    |        |
|---|--------|----|--------|
| 1 | Vcc    | 2  | Vcc    |
| 3 | -Data0 | 4  | -Data1 |
| 5 | +Data0 | 6  | +Data1 |
| 7 | Ground | 8  | Ground |
| 9 | Key    | 10 | NC     |

### COM 1



### CAN bus

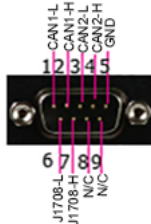

### SMBus Connector (J10)

|   |               |   |            |
|---|---------------|---|------------|
| 1 | +3.3V_standby | 2 | GND        |
| 3 | SMBUS Clock   | 4 | SMBUS Data |
| 5 | SMBUS_Alert   | 6 | NC         |

## Power Board

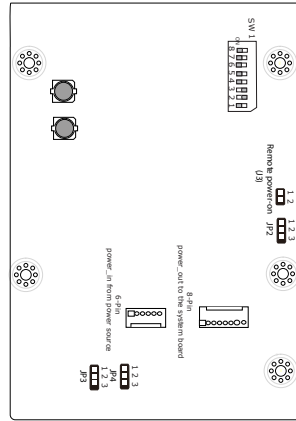

### DC-out to the System Board Connector (8-pin)

|   |           |   |         |
|---|-----------|---|---------|
| 1 | Ground    | 2 | Ground  |
| 3 | Power Off | 4 | UART_TX |
| 5 | UART_RX   | 6 | 12V     |
| 7 | 12V       | 8 | 12V     |

### DC-in from Power Source (6-pin)

|   |        |   |        |
|---|--------|---|--------|
| 1 | Ground | 2 | Ground |
| 3 | IGN    | 4 | IGN    |
| 5 | VCC    | 6 | VCC    |

### Power-on Switch (J3)

|   |          |   |        |
|---|----------|---|--------|
| 1 | Power-on | 2 | Ground |
|---|----------|---|--------|

### Remote Switch Active Signal (JP2)

|     |               |               |                |
|-----|---------------|---------------|----------------|
| 1-2 | Active on low | 2-3 (default) | Active on high |
|-----|---------------|---------------|----------------|

### Host Bus Selection (JP3 & JP4)

|     |          |               |      |
|-----|----------|---------------|------|
| 1-2 | Reserved | 2-3 (default) | UART |
|-----|----------|---------------|------|

### Note:

When selecting the communication method for host bus, please set JP3 and JP4 together.

### GPIO







### GPIO

|   |       |    |      |
|---|-------|----|------|
| 1 | GPIO  | 2  | GPIO |
| 3 | GPIO  | 4  | GPIO |
| 5 | Power | 6  | GPO0 |
| 7 | GPO1  | 8  | GPO2 |
| 9 | GPO3  | 10 | GND  |



## Delay Turn-on/off Switch

The DIP switch (SW1) on the power board can be used to turn on or off the system at a specific on/off delay time via car ignition.

| <b>SW1-1: 12V/24V Input Type</b>   |               |  |                  |                    |
|--|---------------|--|------------------|--------------------|
| This is the selection for power input type. Please make sure this setting matches the power input voltage; if not, the system may not be powered on. |               |  |                  |                    |
|   | On (default)  | 12V  |                  |                    |
|  | Off           | 24V  |                  |                    |
| <b>SW1-2: System-on delay enable/disable</b>   |               |  |                  |                    |
| This is the selection for enabling the system-on delay function.   |               |  |                  |                    |
|   | On            | Enable (delay time setting adjustable by SW1-4 and 1-5 as shown below)                   |                  |                    |
|  | Off (default) | Delay time value will be set in the BIOS (Please refer to the "Vehicle" tab in the BIOS) |                  |                    |
| <b>SW1-4 and 1-5: System-on delay time setting</b>   |               |  |                  |                    |
| Use this switch to set system-on delay time. Please note this setting only works if SW1-2 is set to "ON".  |               |  |                  |                    |
|   | <b>4</b>      | <b>5</b>   | <b>Time</b>      |                    |
|  | On            | On   | 10 sec (default) |                    |
|  | Off           | On   | 30 sec           |                    |
|  | On            | Off  | 1 min            |                    |
|  | Off           | Off  | 5 min            |                    |
| <b>SW1-3: System-off delay enable/disable</b>  |               |  |                  |                    |
|   | On            | Enable (delay time setting adjustable by SW1-6, 1-7 and 1-8 as shown below)              |                  |                    |
|  | Off (default) | Delay time value will be set in the BIOS (Please refer to the "Vehicle" tab in the BIOS) |                  |                    |
| <b>SW1-6, 1-7 and 1-8: System-off delay time setting</b>   |               |  |                  |                    |
| Use this switch to set system-off delay time. Please note this setting only works if SW1-3 is set to "ON".   |               |  |                  |                    |
|   | <b>6</b>      | <b>7</b>   | <b>8</b>         | <b>Time</b>        |
|  | On            | On   | On               | 30 sec (default)   |
|  | Off           | On   | On               | 1 min              |
|  | On            | Off  | On               | 3 min              |
|  | Off           | Off  | On               | 5 min              |
|  | On            | On   | Off              | 10 min             |
|  | Off           | On   | Off              | 15 min             |
|  | On            | Off  | Off              | 30 min             |
|  | Off           | Off  | Off              | 1 system-off delay |



### Note:

The OS will start the shutdown procedure after the car ignition switches off and will complete system shutdown within the specified system-off delay time. Please make sure that system-off delay time is sufficient to allow the OS to shut down completely.