



**KS070-AL**  
**7" Touch Panel PC**  
**User's Manual**

## Copyright

This publication contains information that is protected by copyright. No part of it may be reproduced in any form or by any means or used to make any transformation/adaptation without the prior written permission from the copyright holders.

This publication is provided for informational purposes only. The manufacturer makes no representations or warranties with respect to the contents or use of this manual and specifically disclaims any express or implied warranties of merchantability or fitness for any particular purpose. The user will assume the entire risk of the use or the results of the use of this document. Further, the manufacturer reserves the right to revise this publication and make changes to its contents at any time, without obligation to notify any person or entity of such revisions or changes.

Changes after the publication's first release will be based on the product's revision. The website will always provide the most updated information.

© 2020. All Rights Reserved.

## Trademarks

Product names or trademarks appearing in this manual are for identification purpose only and are the properties of the respective owners.

## FCC and DOC Statement on Class A

This equipment has been tested and found to comply with the limits for a Class A digital device, pursuant to Part 15 of the FCC rules. These limits are designed to provide reasonable protection against harmful interference when the equipment is operated in a residential installation. This equipment generates, uses and can radiate radio frequency energy and, if not installed and used in accordance with the instruction manual, may cause harmful interference to radio communications. However, there is no guarantee that interference will not occur in a particular installation. If this equipment does cause harmful interference to radio or television reception, which can be determined by turning the equipment off and on, the user is encouraged to try to correct the interference by one or more of the following measures:

- Reorient or relocate the receiving antenna.
- Increase the separation between the equipment and the receiver.
- Connect the equipment into an outlet on a circuit different from that to which the receiver is connected.
- Consult the dealer or an experienced radio TV technician for help.

### Notice:

1. The changes or modifications not expressly approved by the party responsible for compliance could void the user's authority to operate the equipment.
2. Shielded interface cables must be used in order to comply with the emission limits.

## Table of Contents

Copyright.....	2	Backlight Power Select.....	17
Trademarks.....	2	Panel Power Select .....	17
FCC and DOC Statement on Class A .....	2	LCD/Inverter Power Select.....	18
About this Manual.....	4	<b>Chapter 5 - Ports and Connectors.....</b>	<b>19</b>
Warranty .....	4	Top Panel I/O Ports .....	19
Static Electricity Precautions .....	4	Bottom Panel I/O Ports .....	19
Safety Measures.....	4	USB Ports.....	20
Safety Precautions .....	5	COM (Serial) Ports.....	21
About the Package.....	5	Graphics Interfaces.....	22
<b>Chapter 1 - Introduction.....</b>	<b>6</b>	Audio Output.....	22
Overview.....	6	DC-in Power Connector .....	23
Key Features .....	6	RJ45 LAN Ports.....	23
Specifications.....	7	<b>I/O Connectors .....</b>	<b>24</b>
Getting to Know the KS070-AL .....	8	Serial ATA Connector & Serial ATA Power Connector.....	24
Mechanical Dimensions .....	9	USB OTG Connector .....	24
<b>Chapter 2 - Getting Started .....</b>	<b>10</b>	LVDS LCD Panel & Inverter Power Connector.....	25
<b>Chapter 3 - Installing Devices.....</b>	<b>11</b>	Digital I/O Connector .....	26
Removing the Chassis Cover.....	12	Expansion Slots .....	26
Installing an M.2 Card.....	13	Front Panel Connector .....	27
<b>Chapter 4 - Jumper Settings.....</b>	<b>15</b>	Standby Power LED .....	27
Clear CMOS Data .....	15	Battery.....	28
LVDS Channel and bpp Select.....	15	SMBus Connector .....	28
Auto Power-on Select.....	16	<b>Chapter 6 - Mounting Options .....</b>	<b>29</b>
M.2 Signal Select.....	16	Wall Mount.....	29
		Panel Mount.....	30
		<b>Chapter 7 - BIOS Setup .....</b>	<b>32</b>
		<b>Chapter 8 - Supported Software .....</b>	<b>44</b>

## About this Manual

An electronic file of this manual is included in the CD. To view the user's manual in the CD, insert the CD into a CD-ROM drive. The autorun screen (Main Board Utility CD) will appear. Click "User's Manual" on the main menu.

## Warranty

1. Warranty does not cover damages or failures that arise from misuse of the product, inability to use the product, unauthorized replacement or alteration of components and product specifications.
2. The warranty is void if the product has been subjected to physical abuse, improper installation, modification, accidents or unauthorized repair of the product.
3. Unless otherwise instructed in this user's manual, the user may not, under any circumstances, attempt to perform service, adjustments or repairs on the product, whether in or out of warranty. It must be returned to the purchase point, factory or authorized service agency for all such work.
4. We will not be liable for any indirect, special, incidental or consequential damages to the product that has been modified or altered.

## Static Electricity Precautions

It is quite easy to inadvertently damage your PC, system board, components or devices even before installing them in your system unit. Static electrical discharge can damage computer components without causing any signs of physical damage. You must take extra care in handling them to ensure against electrostatic build-up.

1. To prevent electrostatic build-up, leave the system board in its anti-static bag until you are ready to install it.
2. Wear an antistatic wrist strap.
3. Do all preparation work on a static-free surface.
4. Hold the device only by its edges. Be careful not to touch any of the components, contacts or connections.
5. Avoid touching the pins or contacts on all modules and connectors. Hold modules or connectors by their ends.



### Important:

Electrostatic discharge (ESD) can damage your processor, disk drive and other components. Perform the upgrade instruction procedures described at an ESD workstation only. If such a station is not available, you can provide some ESD protection by wearing an antistatic wrist strap and attaching it to a metal part of the system chassis. If a wrist strap is unavailable, establish and maintain contact with the system chassis throughout any procedures requiring ESD protection.

## Safety Measures

To avoid damages to the system:

- Use the correct AC input voltage range.

To reduce the risk of electric shock:

- Unplug the power cord before removing the system chassis cover for installation or servicing. After installation or servicing, cover the system chassis before plugging the power cord.

Battery:

- Danger of explosion if battery incorrectly replaced.
- Replace only with the same or equivalent type recommend by the manufacturer.
- Dispose of used batteries according to local ordinance.

## Safety Precautions

- Use the correct DC input voltage range.
- Unplug the power cord before removing the system chassis cover for installation or servicing. After installation or servicing, cover the system chassis before plugging the power cord.
- Danger of explosion if battery incorrectly replaced.
- Replace only with the same or equivalent type recommend by the manufacturer.
- Dispose of used batteries according to local ordinance.
- Keep this system away from humidity.
- Place the system on a stable surface. Dropping it or letting it fall may cause damage.
- The openings on the system are for air ventilation to protect the system from overheating. **DO NOT COVER THE OPENINGS.**
- Place the power cord in such a way that it will not be stepped on. Do not place anything on top of the power cord. Use a power cord that has been approved for use with the system and that it matches the voltage and current marked on the system's electrical range label.
- If the system will not be used for a long time, disconnect it from the power source to avoid damage by transient overvoltage.
- If one of the following occurs, consult a service personnel:
  - The power cord or plug is damaged.
  - Liquid has penetrated the system.
  - The system has been exposed to moisture.
  - The system is not working properly.
  - The system dropped or is damaged.
  - The system has obvious signs of breakage.
- The unit uses a three-wire ground cable which is equipped with a third pin to ground the unit and prevent electric shock. Do not defeat the purpose of this pin. If your outlet does not support this kind of plug, contact your electrician to replace the outlet.
- Disconnect the system from the DC outlet before cleaning. Use a damp cloth. Do not use liquid or spray detergents for cleaning.

## About the Package

The package contains the following items. If any of these items are missing or damaged, please contact your dealer or sales representative for assistance.

- One 7" Touch Panel PC
- One sheet of poron foam
- One CD disk includes: Drivers and Manual

## Optional Items

- VESA mount kit
- Panel mount kit
- Power cord

The board and accessories in the package may not come similar to the information listed above. This may differ in accordance to the sales region or models in which it was sold. For more information about the standard package in your region, please contact your dealer or sales representative.

## Chapter 1 - Introduction

### Overview

#### KS070-AL

Side View



Top View



Bottom View



### Key Features

<b>Model Name</b>	<b>KS070-AL</b>
<b>Processor</b>	Intel Atom® Processor E3900 Series, BGA 1296 Intel Atom® x5-E3940 Processor, Quad Core, 2M Cache, 1.6GHz (1.8GHz), 9.5W Intel® Celeron® Processor N3350, Dual Core, 2M Cache, 1.1GHz (2.4GHz), 6W
<b>LAN</b>	Two LAN ports on the bottom panel
<b>COM</b>	Two COM ports (DB-9) on the top panel
<b>Display</b>	DP++ and VGA ports on the bottom panel
<b>USB</b>	Two USB 2.0 ports (type A) and two USB 3.0 ports (type A)
<b>Audio</b>	Line-out and Mic-in jacks

## Specifications

<b>Processor</b>	Intel Atom® Processor E3900 Series, BGA 1296 Intel Atom® x5-E3940 Processor, Quad Core, 2M Cache, 1.6GHz (1.8GHz), 9.5W Intel® Celeron® Processor N3350, Dual Core, 2M Cache, 1.1GHz (2.4GHz), 6W
<b>Memory</b>	One 204-pin SODIMM up to 8GB Single Channel DDR3L 1866MHz (4GB memory by default)
<b>BIOS</b>	Insyde SPI 128Mbit (supports UEFI boot only)
<b>Display and Touch Screen</b>	<ul style="list-style-type: none"> <li>• Display: 7" 800x480 TFT LCD panel with capacitive/resistive touch screen</li> <li>• Brightness: 500 cd/m<sup>2</sup></li> <li>• Contrast: 400:1</li> <li>• Backlight Lifetime: 50,000 hours</li> </ul>
<b>Graphics</b>	<ul style="list-style-type: none"> <li>• Intel® HD Graphics</li> </ul> Display port: VGA (resolution up to 1920x1200 @ 60Hz) & DP++: resolution up to 4096x2160 @ 60Hz Supported applications: OpenGL 4.2, DirectX 11.1, OpenCL 1.2, OpenGL ES 3.0 Supported Codecs: HW Decode: H.264, MPEG2, VC1, VP8, H.265, MPEG4 HW Encode: H.264, MPEG2, MPEG4
<b>Storage</b>	CFast Socket
<b>Expansion</b>	1 x Full-size Mini PCIe (USB/Pcie) 1 x M.2 2242 B-key (PCIe/USB 2.0/SATA 3.0)
<b>Audio Controller</b>	Realtek ALC262
<b>Ethernet Controller</b>	2 x Intel® I211AT PCIe (10/100/1000Mbps)
<b>Top I/O Ports</b>	2 x RS-232/422/485 (DB-9) 1 x 8-bit DIO (DB-9) (available upon request) 3 x Wi-Fi module antenna holes
<b>Bottom I/O Ports</b>	2 x GbE (RJ-45) (10/100/1000Mbps) 2 x USB 2.0 (type A) & 2 x USB 3.0 (type A) 1 x Power button 1 x Line-out & 1 x Mic-in port 1 x DC-in connector 1 x DP++ & 1 x VGA port
<b>Watchdog Timer</b>	System Reset, Programmable via Software from 1 to 255 Seconds
<b>Power</b>	Type: 12V DC Connector: DC Jack
<b>OS Support (UEFI only)</b>	Windows 10 IoT Enterprise 64-bit

<b>Mechanism</b>	Construction: sheet metal IP Rating: IP65 front panel protection Mounting: VESA/panel mount (*) Weight: 1.5 kg Dimensions (W x H x D): 230mm x 150mm x 58.3mm
<b>Environment</b>	Operating Temperature: -20 to 55°C Storage Temperature: -30 to 80°C Relative Humidity: 5 to 85% RH (non-condensing)
<b>Tests and Certification</b>	Shock: OP: Half-sine, 3G @ 11ms Non-OP: Half-sine, 5G @ 11ms Vibration: OP: Random, 1Grms @ 5~500Hz, 30min Non-OP: Sweep sine, 3Grms @ 10~500Hz, 30min

**Note:**

\*Optional items are not supported in standard model. Please contact your sales representative for more information.

## Getting to Know the KS070-AL

### Top View

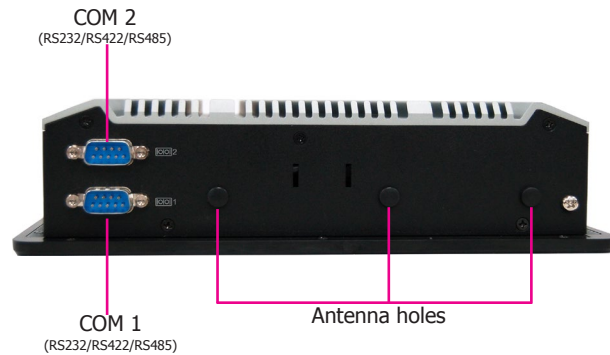

#### COM Ports

COM 1 and COM 2 can be an RS232, RS422 or RS485 port.

#### Wireless Antenna Holes

Reserved for installing wireless antennas.

### Bottom View

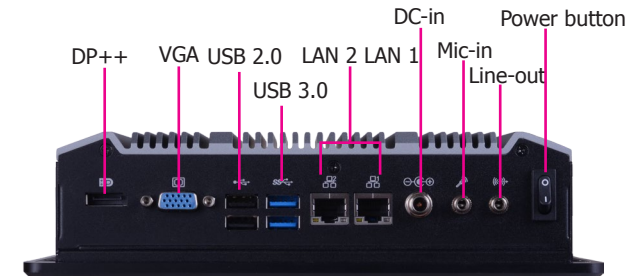

#### Power Button

Press to power on or power off the system.

#### Line-out

Connects a speaker.

#### Mic-in

Connects a microphone.

#### DC-in

Plug a power adapter into this socket.

#### LAN Ports

Connect a network device or a Ethernet cable for network connectivity.

#### USB 3.0 Ports

Connect USB 3.0 devices as well as devices from previous versions such as USB 2.0 or USB 1.1.

#### USB 2.0 Ports

Connect USB 2.0 or 1.1 devices.

#### VGA Port

Connects to the VGA port of a display.

#### DP++ Port

Connects to the dual-mode DisplayPort of a display.



Mechanical Dimensions

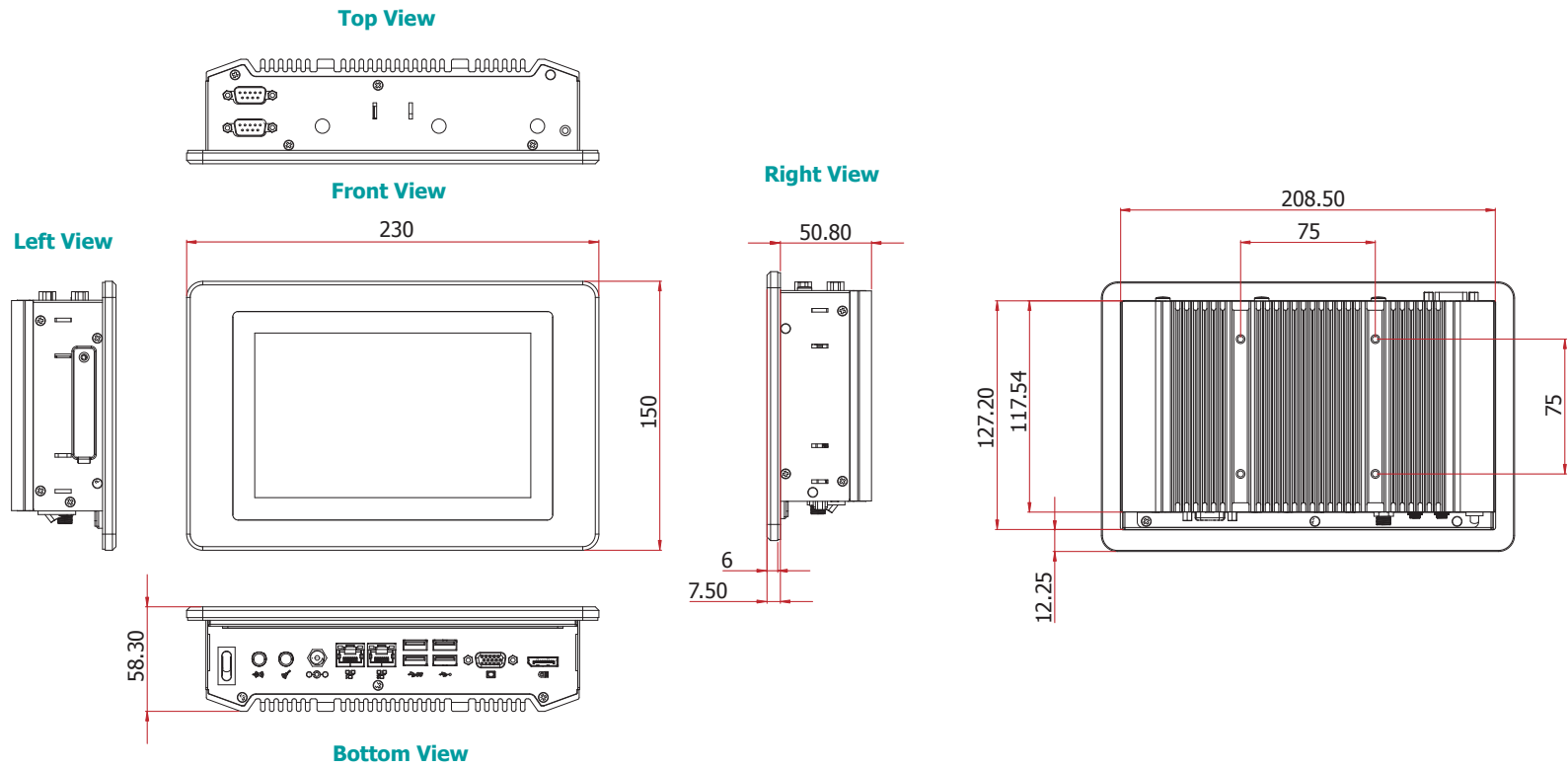

## Chapter 2 - Getting Started

---

### Preparing the System

Before you start using the system, you need the following items:

- CFast card or M.2 card
- AC power adapter

### Installing Devices

The following devices can be installed in the system.

- SODIMM
- Mini PCIe card
- CFast card or M.2 card

### Configuring the BIOS

To get you started, you may need to change configurations such as the date, time and the type of hard disk drive.

1. Power on the system.
2. After the memory test, the message "Press DEL to run setup" will appear on the screen. Press the Delete key to enter the BIOS setup utility.

### Installing an Operating System

Depending on the method you choose to install your system, you may use a USB flash drive or install a CD-ROM drive to run the Operating System CD.

Make sure that a CFast or an M.2 card is already installed.

1. Refer to the following chapters for information on installing a CFast or an M.2 card.
2. Refer to your operating system manual for instructions on installing an operating system.

### Installing the Drivers

The system package includes a CD disk. The CD includes drivers that must be installed to provide the best system performance. Refer to the Supported Software chapter for instructions on installing the drivers.

## Chapter 3 - Installing Devices

### Installing a CFast Card

The CFast card slot can be accessed externally without opening the chassis. Before installing a CFast card, take off the CFast card slot cover.

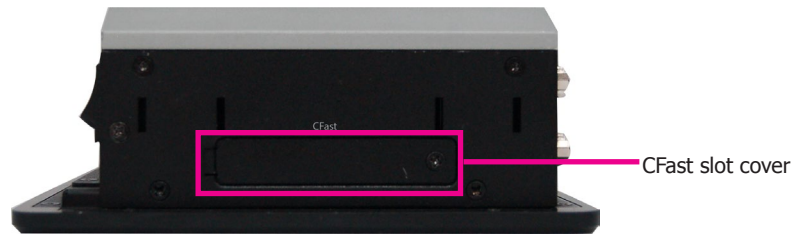

1. Gently insert the CFast card straight with the label on the CFast card facing up until you feel it lock into place. Do not force the card into the slot if the card is not correctly inserted.



2. Close the CFast card cover and attach the screw. To eject the card, push the card inward to release the lock and pull it out.



## Removing the Chassis Cover

1. Make sure the system and all other peripheral devices connected to it have been powered off.
2. Disconnect all power cords and cables.
3. The 12 mounting screws on the top and bottom as well as both sides of the system are used to secure the cover to the chassis. Remove these screws and put them in a safe place for later use.

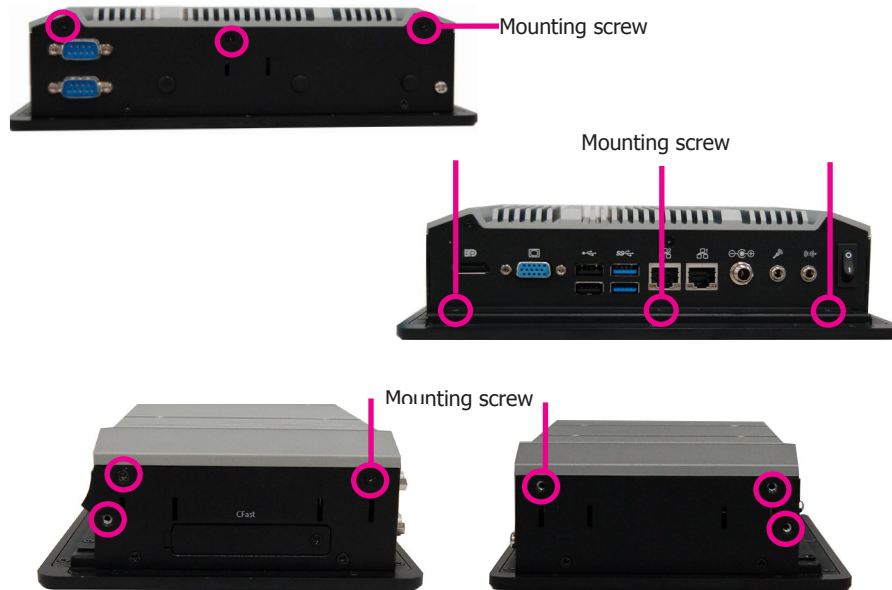

4. Lift the cover up to open the system.



5. The Mini PCIe and the M.2 sockets are readily accessible after removing the chassis cover.

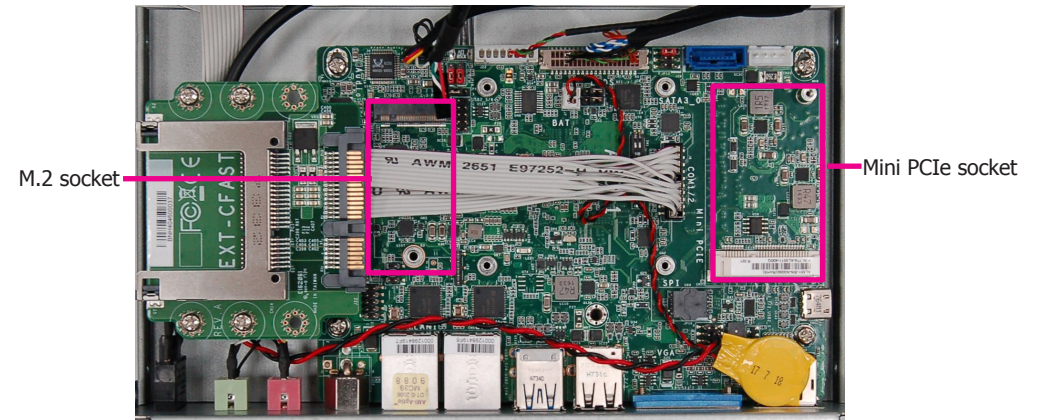

## Installing an M.2 Card

The system is equipped with one M.2 socket, supporting the M.2 22x42mm (key B) form factor. Use the following procedure to install an M.2 card:

1. Align the notch at the edge of the M.2 card with the key in the connector.
2. Insert the M.2 card into the connector.

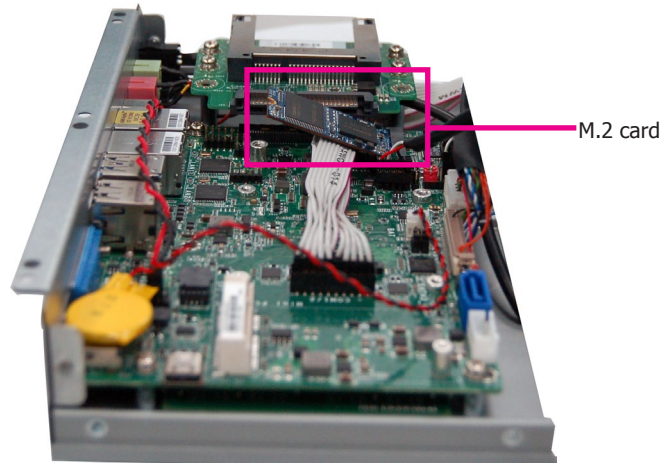

3. Push down on the other end of the M.2 card and secure card on the mainboard with the provided mounting screw.

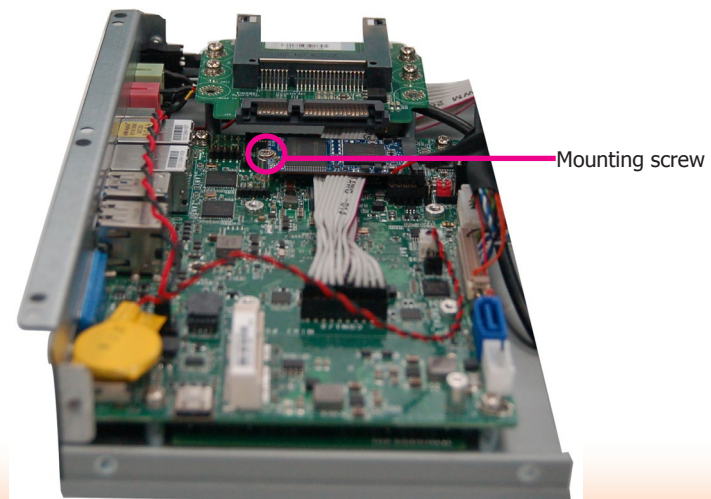
**Note:**

The M.2 socket supports PCIe, USB, and SATA signals and can accommodate common mobile broadband and storage modules. For jumper settings on switching the signal between SATA and PCIe, refer to Chapter 4.

## Installing a Mini PCIe Card

The system board is equipped with one Mini PCIe slot that supports PCIe and USB signals. Use the following procedure to install a Mini PCIe card:

1. Grasp the Mini PCIe card by its edges and align the notch in the connector of the PCIe card with the key in the connector on the system board.

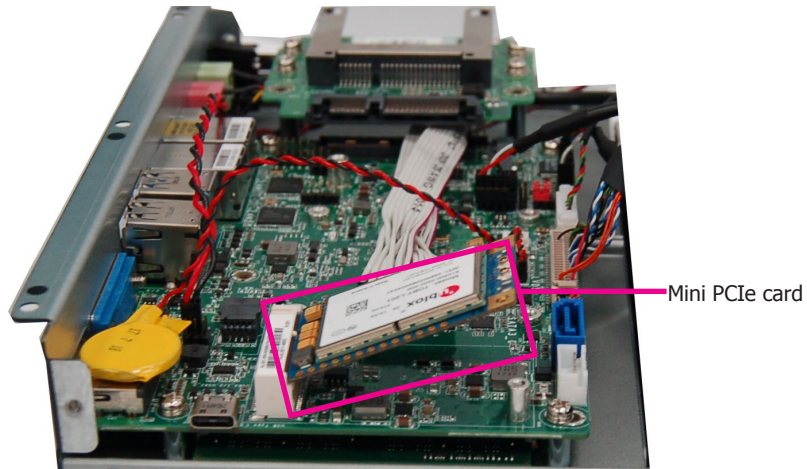

2. Push the Mini PCIe card down and use the provided mounting screws to secure the card on the system board.

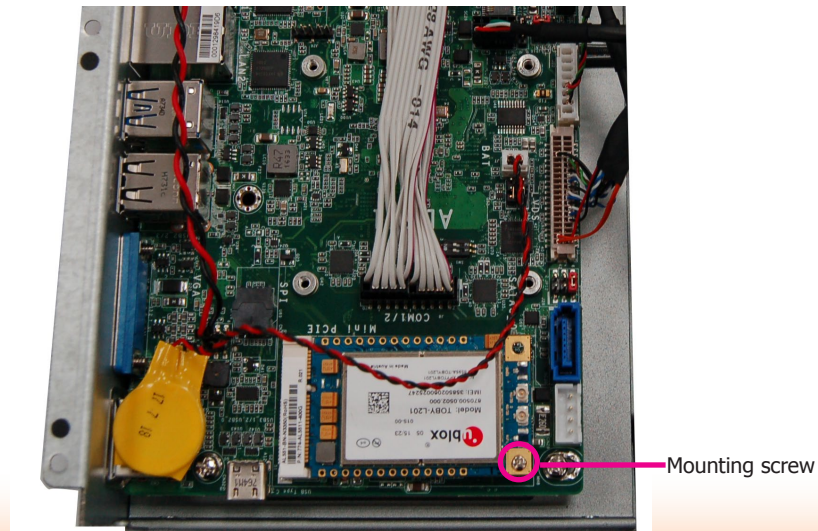

## Chapter 4 - Jumper Settings

### Clear CMOS Data

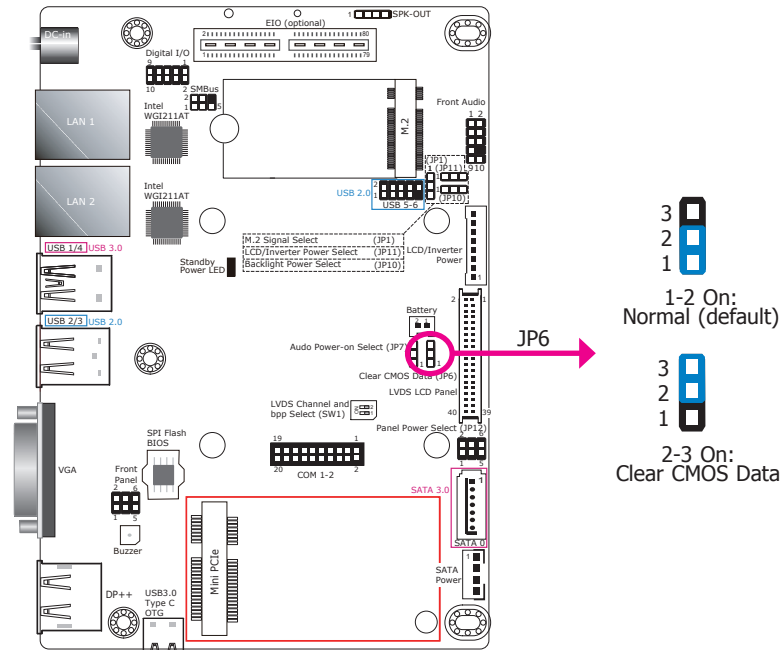

You can reconfigure the system with the default values stored in the ROM BIOS if you encounter the following situations:

- CMOS data becomes corrupted.
- You forgot the supervisor or user password.

To load the default values stored in the ROM BIOS, please follow these steps below:

- Power off the system and unplug the power cord.
- Set the jumper pins 2 and 3 to On. Wait for a few seconds and set the jumper back to its default setting, pins 1 and 2 On.
- Now plug the power cord and power on the system.

### LVDS Channel and bpp Select

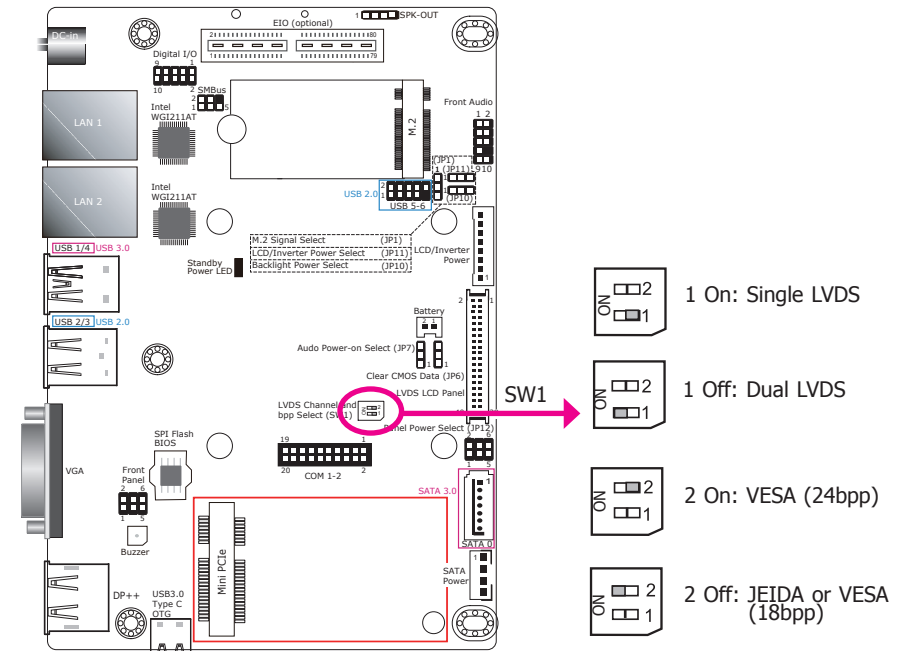

Switch 1 is used to select the LVDS channel and the color of bits per pixel.

## Auto Power-on Select

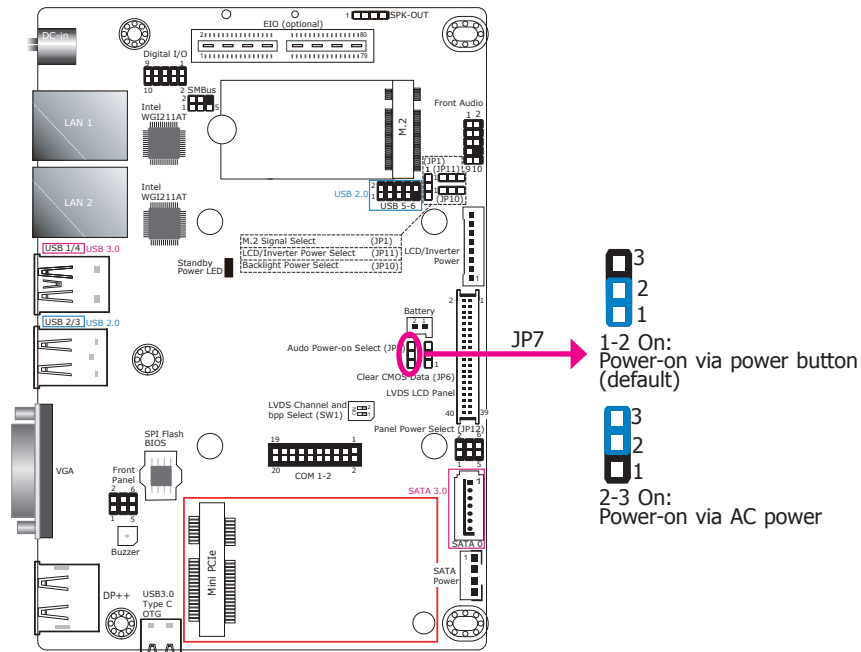

JP7 is used to select the method of powering on the system. If you want the system to power on whenever AC power comes in, set JP7 pins 2 and 3 to On. If you want to use the power button, set pins 1 and 2 to On.

When using the JP7 "Power On" feature to power the system back on after a power failure, the system may not power on if the power loss is resumed within 5 seconds (i.e., power flicker).

## M.2 Signal Select

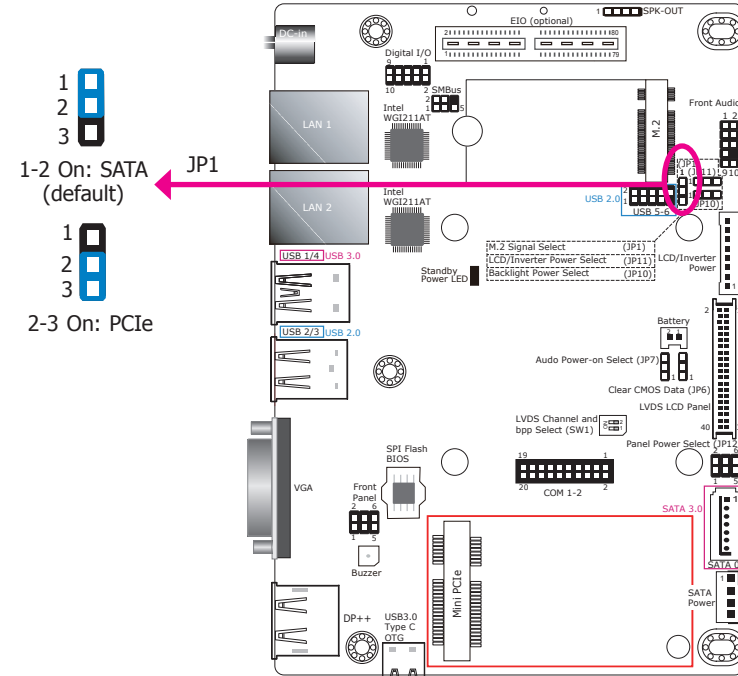

JP1 is used to select the signal for the M.2 socket: SATA (default) or PCIe.



## Backlight Power Select

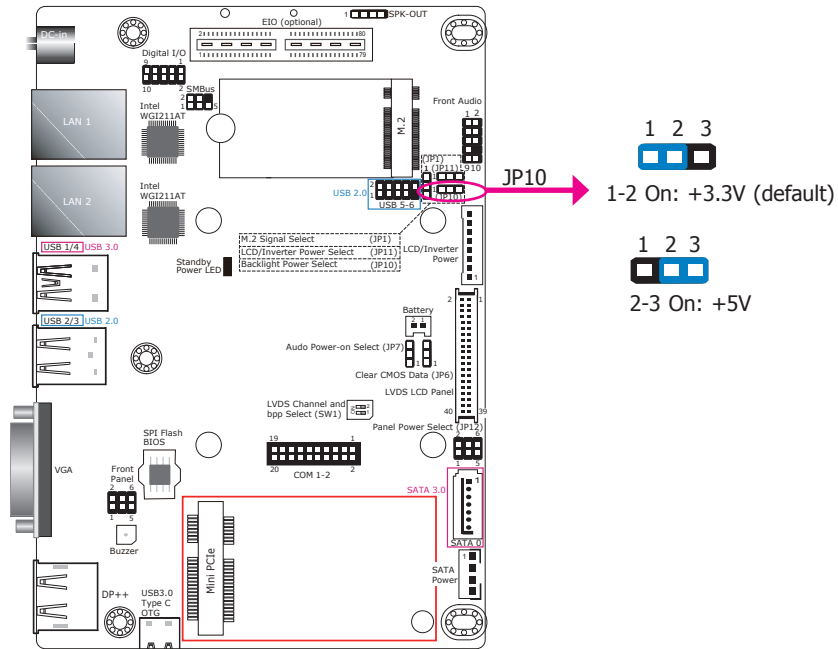

JP10 is used to select the power level of backlight brightness control: +5V or +3.3V (default).

**Important:**

Before powering on the system, make sure that the power settings of JP10 match the power specification of backlight control. Selecting the incorrect voltage will seriously damage the backlight.

## Panel Power Select

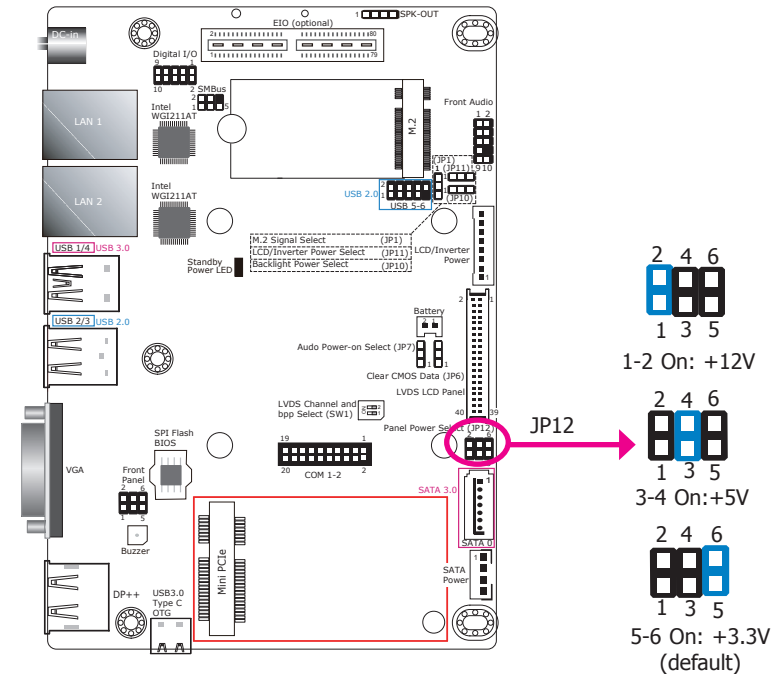

JP12 is used to select the power supplied with the LCD panel.

**Important:**

Before powering on the system, make sure that the power settings of JP12 match the LCD panel's specification. Selecting the incorrect voltage will seriously damage the LCD panel.

## LCD/Inverter Power Select

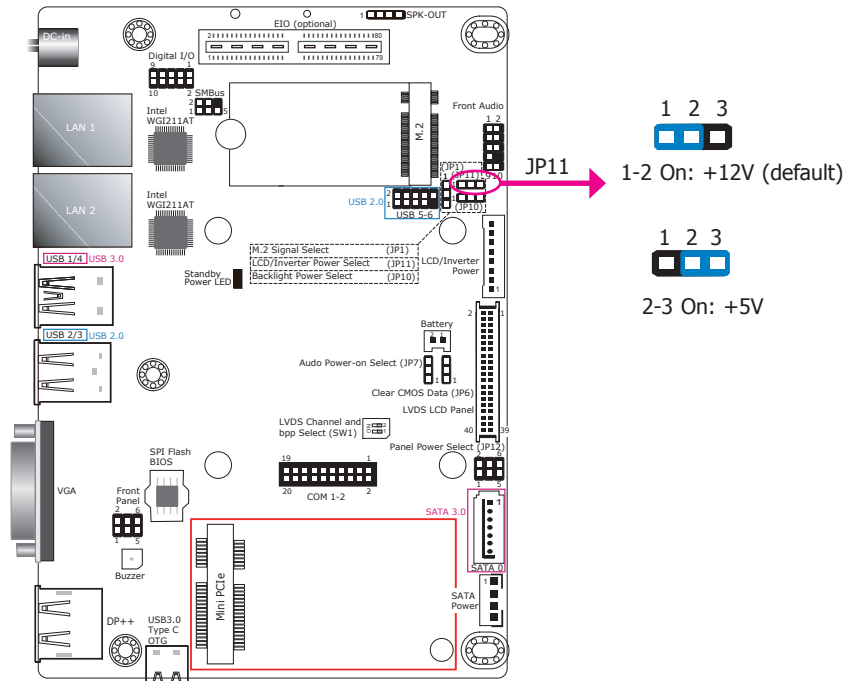

JP11 is used to select the power level of the LCD/inverter power connector.

## Chapter 5 - Ports and Connectors

### Top Panel I/O Ports

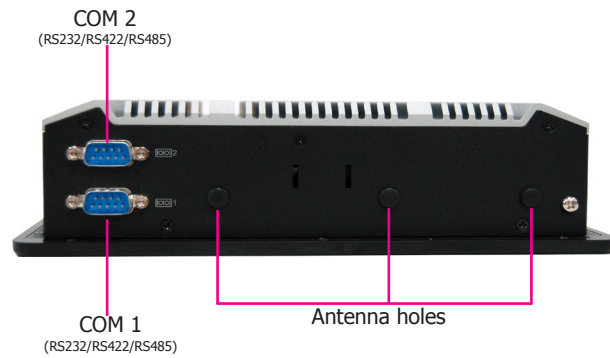

The top panel I/O consists of the following ports and connectors:

- COM ports:  
COM 1 and COM 2 can be an RS232, RS422 or RS485 port.

### Bottom Panel I/O Ports

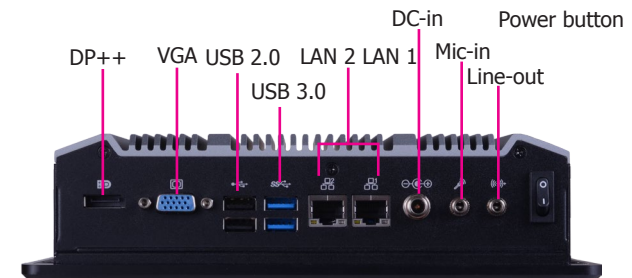

The bottom panel I/O consists of the following ports and connectors:

- Power button
- Line-out
- Mic-in
- DC-in
- LAN ports
- USB 3.0 ports
- USB 2.0 ports
- VGA port
- DP++ port

## USB Ports

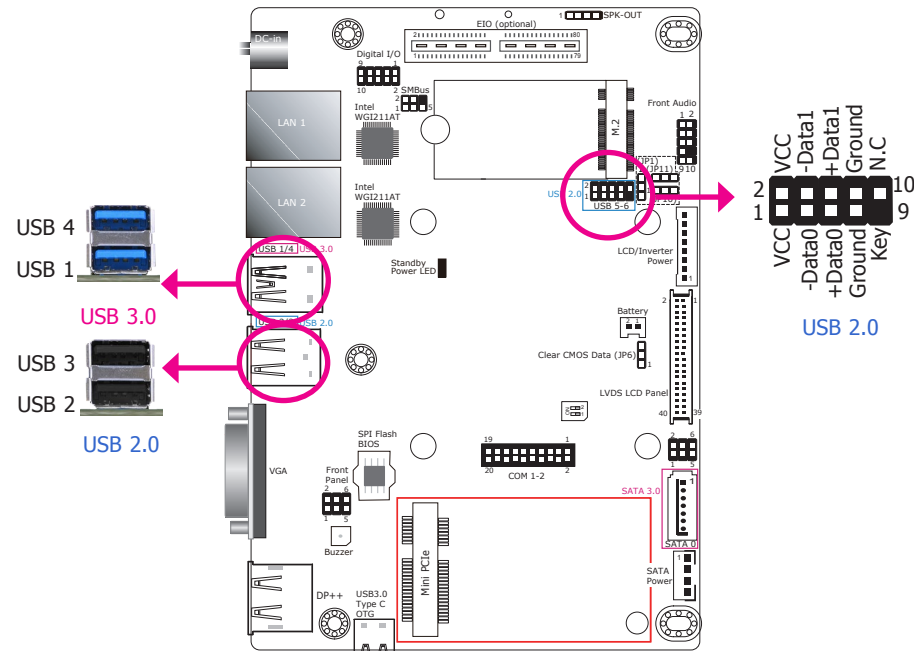

The USB device allows data exchange between your computer and a wide range of simultaneously accessible external Plug and Play peripherals.

The system board is equipped with 2 onboard USB 3.0 ports (USB 1 & USB 4) and 2 onboard USB 2.0 ports (USB 2 & USB 3). The 10-pin connector allows you to connect 2 additional USB 2.0 ports (USB 5-6).

## BIOS Setting

Configure the onboard USB in the Advanced menu ("USB Configuration" submenu) of the BIOS. Refer to Chapter 7 for more information.

## Driver Installation

You may need to install the proper drivers in your operating system to use USB devices. Refer to Chapter 8 for more information.

## Wake-On-USB Keyboard/Mouse

The Wake-On-USB Keyboard/Mouse function allows you to use a USB keyboard or USB mouse to wake up a system from the S3 (STR - Suspend To RAM) state.



### Important:

If you are using the Wake-On-USB Keyboard/Mouse function for 2 USB ports, the +5V\_standby power source of your power supply must support  $\geq 1.5A$ . For 3 or more USB ports, the +5V\_standby power source of your power supply must support  $\geq 2A$ .

## COM (Serial) Ports

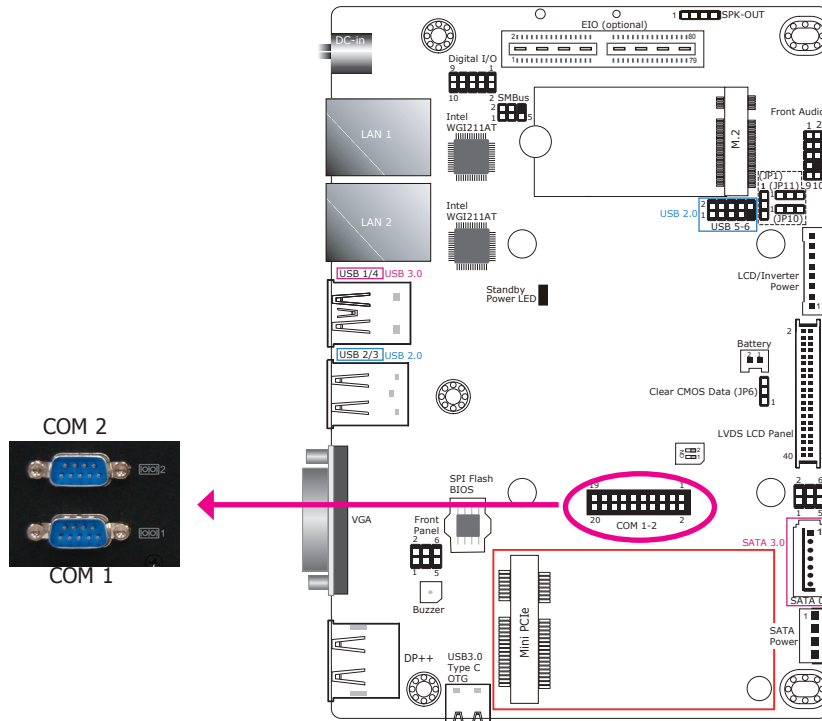

## COM Port Connector

COM 1 (RS232/422/485) / COM 2 (RS232/422/485)

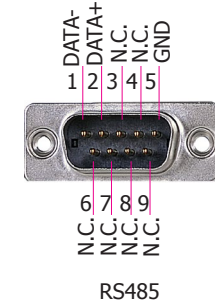
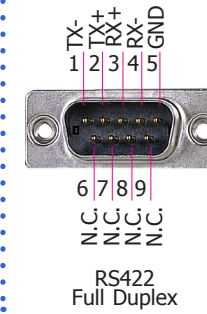
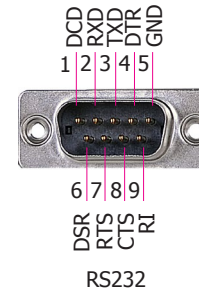

COM 1 and COM 2 can be selected among RS232, 422 and 485.

The serial ports are asynchronous communication ports with 16C550A-compatible UARTs that can be used with modems, serial printers, remote display terminals, and other serial devices.

Please use the BIOS setup utility to configure serial port communication mode for COM 1 and COM 2.

### BIOS Setting

Configure the serial ports including the serial communication mode in the Advanced Configuration ("Super I/O Configuration" submenu) of the BIOS. Refer to Chapter 7 for more information.

## Graphics Interfaces

The display ports consist of the following:

- 1 VGA port
- 1 DP++ port

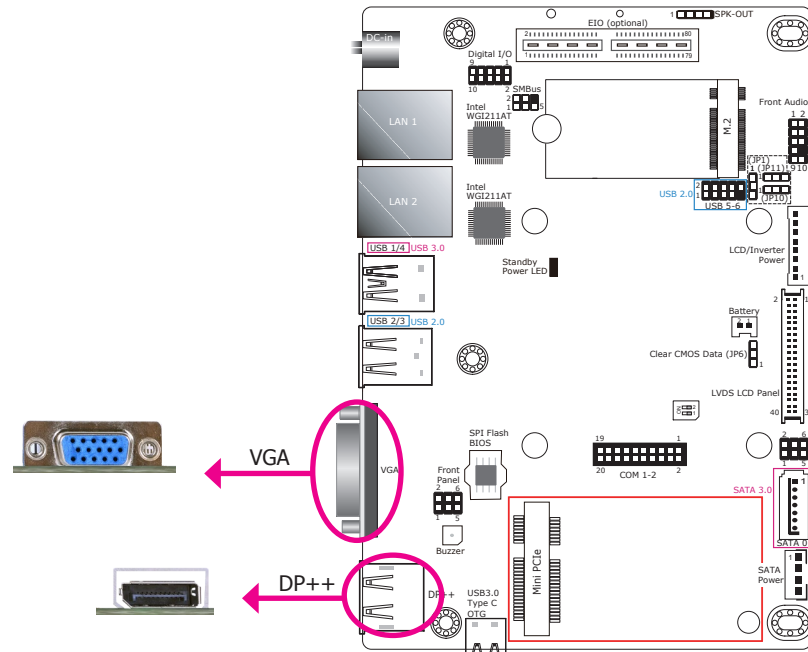

### VGA Port

The VGA port is used for connecting a VGA monitor. Connect the monitor's 15-pin D-shell cable connector to the VGA port. After you plug the monitor's cable connector into the VGA port, gently tighten the cable screws to hold the connector in place.

### DP++ Port

The DisplayPort is a digital display interface used to connect a display device such as a computer monitor. It is used to transmit audio and video simultaneously. The interface, which is developed by VESA, delivers higher performance features than any other digital interfaces.

### Driver Installation

Install the graphics driver. Refer to Chapter 8 for more information.

## Audio Output

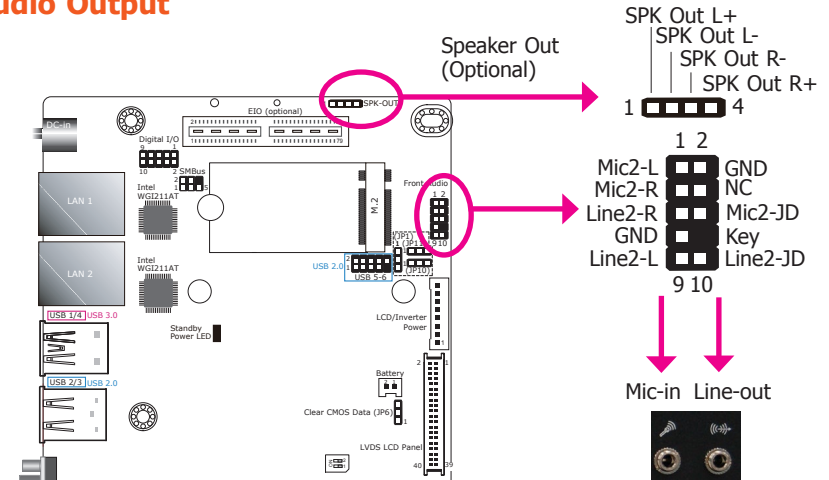

### Front Audio

This Line-out jack is used to connect a headphone or external speakers. And the MIC-in connector is used to connect an external microphone.

### Speaker Out (optional)

The audio speaker out connector supports 2 x 3W speaker.

### Driver Installation

Install the audio drivers. Refer to Chapter 8 for more information.

## DC-in Power Connector

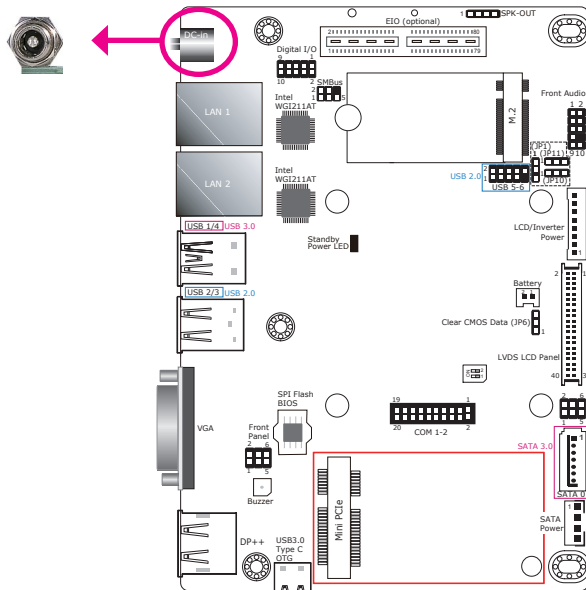

Connect a DC power cord to this jack. Use a power adapter within 12V DC output voltage. Using a power adapter that does not conform to the specified voltage may fail to boot the system or cause damage to the system board.

## RJ45 LAN Ports

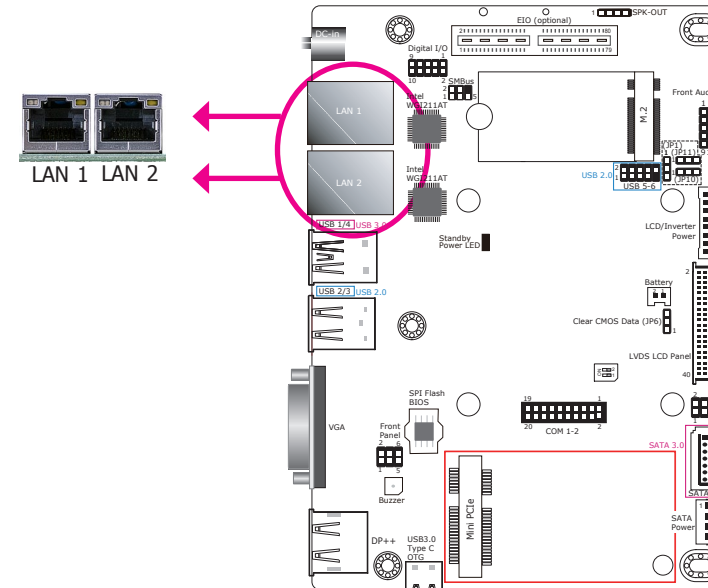

### Features

- 2 Intel® I211AT PCI Express Gigabit Ethernet controllers

The LAN ports allow the system to connect to a local area network for Ethernet connectivity.

### BIOS Setting

Configure the onboard LAN in the Advanced menu (“ACPI Configuration” submenu) of the BIOS. Refer to Chapter 3 for more information.

### Driver Installation

Install the LAN drivers. Refer to Chapter 7 for more information.

## I/O Connectors

### Serial ATA Connector & Serial ATA Power Connector

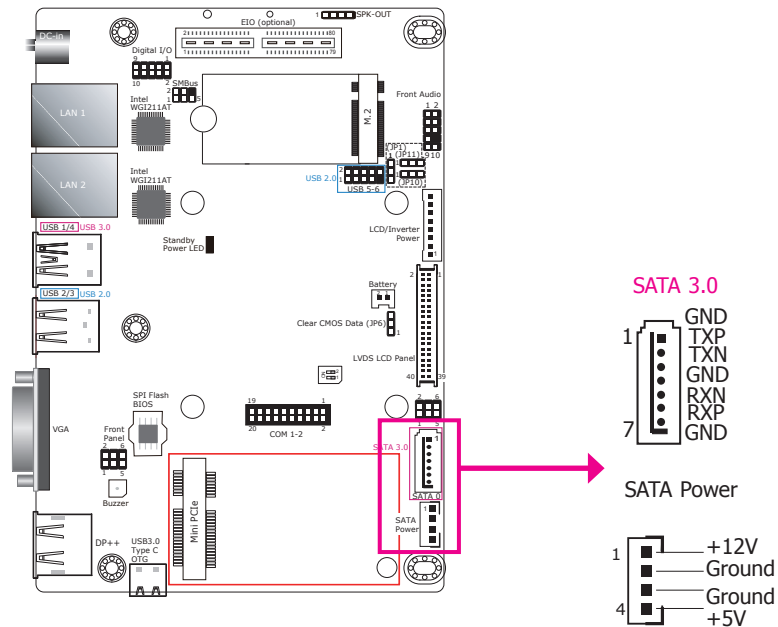

### USB OTG Connector

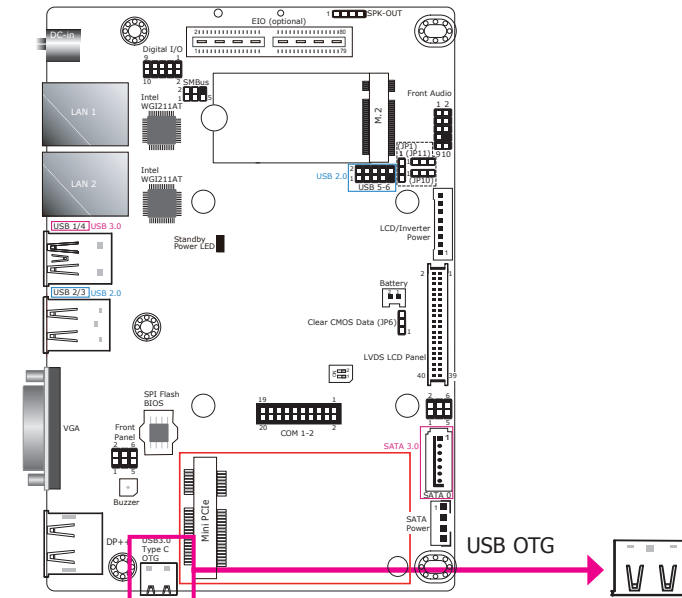

### Features

- 1 Serial ATA 3.0 port with data transfer rate up to 6Gb/s
- Integrated Advanced Host Controller Interface (AHCI) controller

The Serial ATA connector is used to connect the Serial ATA device. Connect one end of the Serial ATA data cable to a SATA connector and the other end to your Serial ATA device.

### BIOS Setting

Configure the Serial ATA drive in the Advanced menu ("SATA Configuration" submenu) of the BIOS. Refer to Chapter 7 for more information.

The USB OTG (USB 2.0) connector is used for USB communication and it allows the system board and the devices connected to it to switch back and forth between the roles of host and device. When the system board is in host mode, it acts as a computer and allows USB peripherals to be connected through the USB OTG port. And when the system board is in device mode, it can be used to read and write to the onboard eMMC memory from your host computer.



## LVDS LCD Panel & Inverter Power Connector

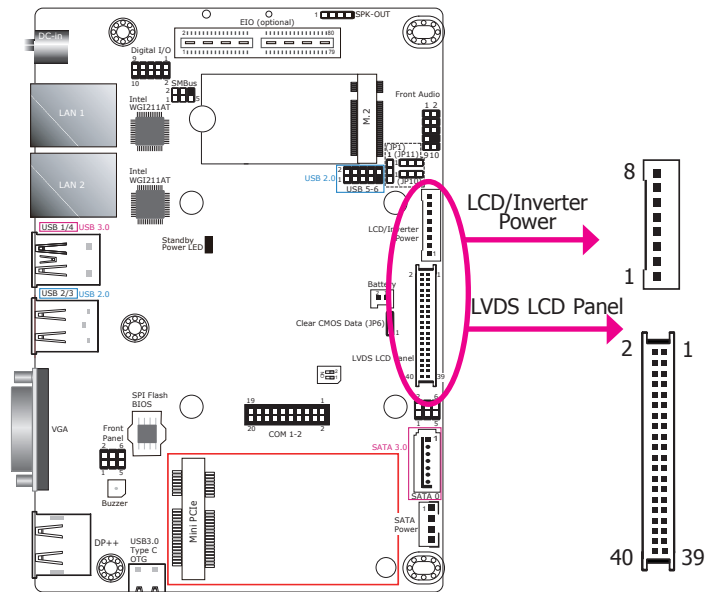

The system board allows you to connect a LCD Display Panel with the LVDS LCD panel connector and the LCD/Inverter power connector. These connectors transmit video signals and power from the system board to the LCD Display Panel.

Refer to the right side for the pin functions of these connectors.

### BIOS Setting

Configure the LCD panel in the Advanced menu ("Video Configuration" submenu) of the BIOS. Refer to Chapter 7 for more information.

## LVDS LCD Panel Connector

Pins	Function	Pins	Function
1	GND	2	GND
3	LVDS_Out3+ (Odd_3+)	4	LVDS_Out7+ (Even_3+)
5	LVDS_Out3- (Odd_3-)	6	LVDS_Out7- (Even_3-)
7	GND	8	GND
9	LVDS_Out2+ (Odd_2+)	10	LVDS_Out6+ (Even_2+)
11	LVDS_Out2- (Odd_2-)	12	LVDS_Out6- (Even_2-)
13	GND	14	GND
15	LVDS_Out1+ (Odd_1+)	16	LVDS_Out5+ (Even_1+)
17	LVDS_Out1- (Odd_1-)	18	LVDS_Out5- (Even_1-)
19	GND	20	GND
21	LVDS_Out0+ (Odd_0+)	22	LVDS_Out4+ (Even_0+)
23	LVDS_Out0- (Odd_0-)	24	LVDS_Out4- (Even_0-)
25	GND	26	GND
27	LVDS_CLK1+ (Odd_CLK+)	28	LVDS_CLK2+ (Even_CLK+)
29	LVDS_CLK1- (Odd_CLK-)	30	LVDS_CLK2- (Even_CLK-)
31	GND	32	GND
33	DDC_CLK	34	N.C.
35	DDC_DATA	36	+3.3V
37	Panel Power	38	Panel Power
39	Panel Power	40	Panel Power

## LCD/Inverter Power Connector

Pins	Function
1	GND
2	GND
3	Dimming Control
4	Panel Power
5	+3.3V
6	Panel Backlight On/Off Control
7	LCD/Inverter Power
8	LCD/Inverter Power

## Digital I/O Connector

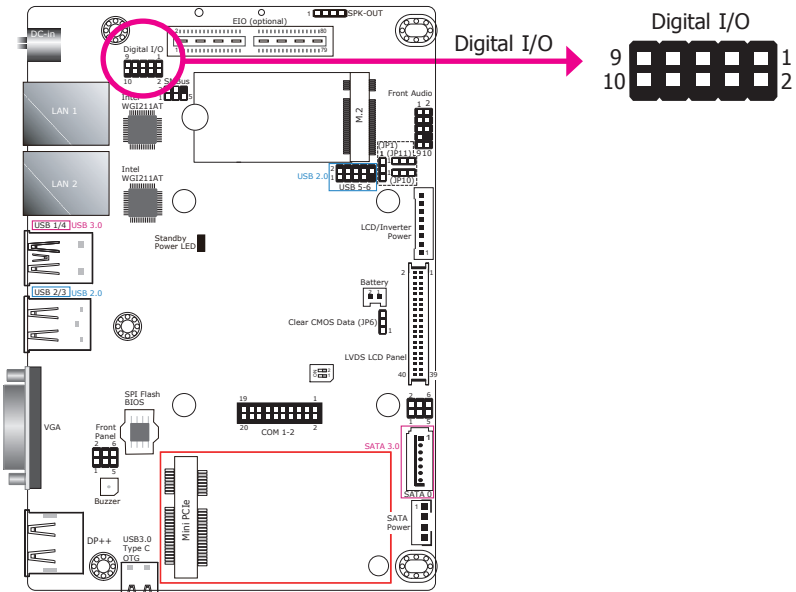

The 8-bit Digital I/O connector provides monitoring and control function to external devices connected to the connector.

### Digital I/O Connector

Pins	Function
1	DIO7
2	DIO6
3	DIO5
4	DIO4
5	DIO3
6	DIO2
7	DIO1
8	DIO0
9	5V
10	GND

## Expansion Slots

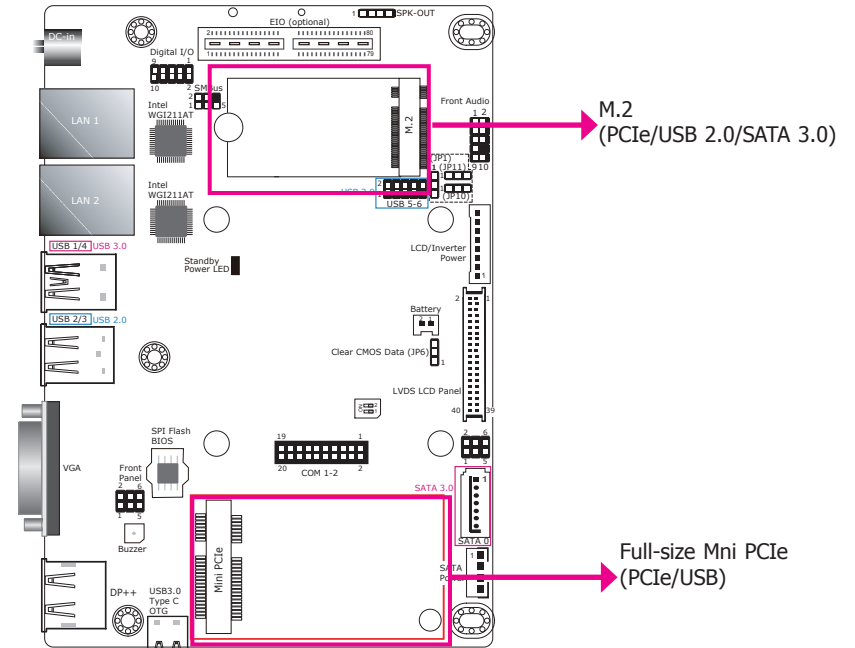

### M.2 Slot

The M.2 slot on the top side of the system board is used to install M.2 (NGFF) modules. The M.2 Type 2242 (B Key) slot can be inserted with a SATA SSD card or wireless module with the form factor of 42mm.

### Mini PCI Express Slot

The full-size Mini PCIe socket supports PCIe x1 and USB 2.0 signals and is used to install a Mini PCIe card.

### Front Panel Connector

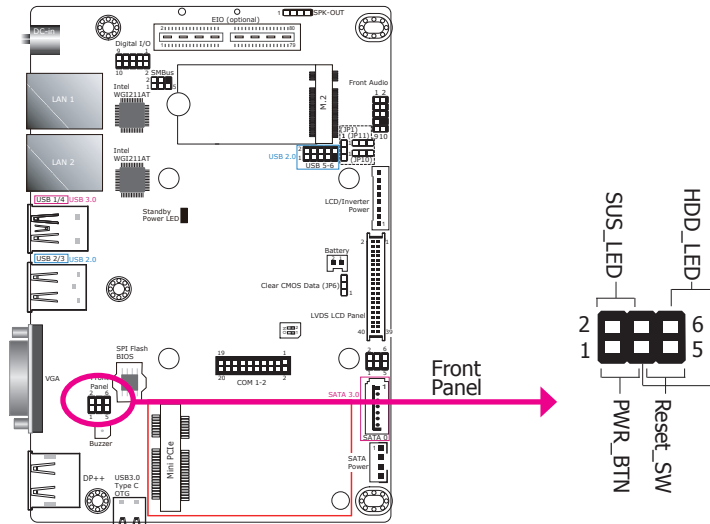

### Standby Power LED

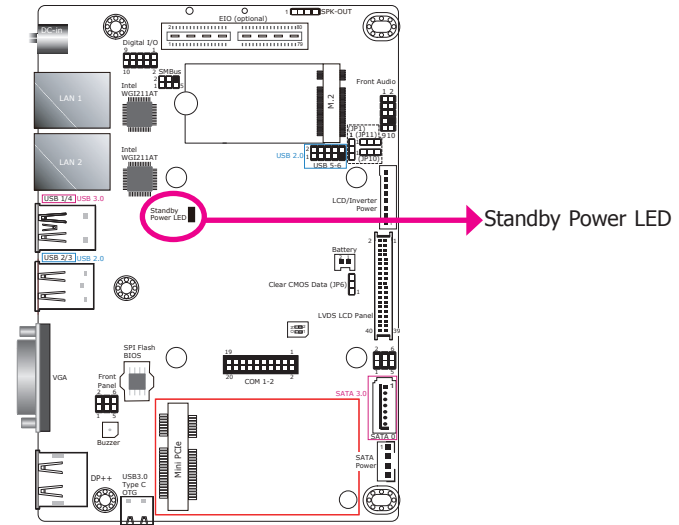

### HDD\_LED - HDD LED

This LED will be lit when the hard drive is being accessed.

### RESET\_SW - Reset Switch

This switch allows you to reboot without having to power off the system.

### PWR\_BTN - Power Button

This switch is used to power on or off the system.

### SUS\_LED - Status LED

When the system's power is on, this LED will be lit. When the system is in the S1 (POS - Power On Suspend) state, it will blink every second. When the system is in the S3 (STR - Suspend To RAM) state, it will blink every 4 seconds.

This LED will light up red when the system is in the standby mode. It indicates that there is power on the system board. Power-off the PC and then unplug the power cord prior to installing any devices. Failure to do so will cause severe damage to the motherboard and components.

	Pin	Pin Assignment		Pin	Pin Assignment
HDD_LED	6	HDD_LED	RESET_SW	5	Reset Button
	3	GND		3	GND
SUS_LED	4	SUS_LED	PWR_BTN	1	Power Button
	2	V_LED		3	GND

## Battery

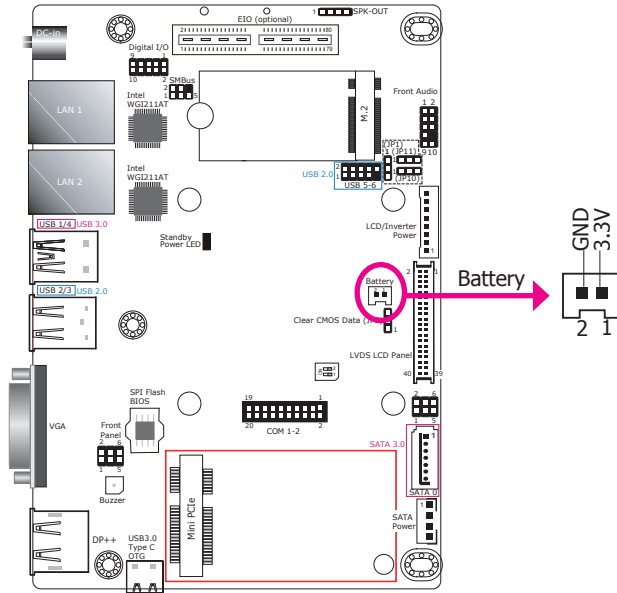

Connect to the battery connector

The lithium ion battery powers the real-time clock and CMOS memory. It is an auxiliary source of power when the main power is shut off.

### Safety Measures

- Danger of explosion if battery incorrectly replaced.
- Replace only with the same or equivalent type recommend by the manufacturer.
- Dispose of used batteries according to local ordinance.

## SMBus Connector

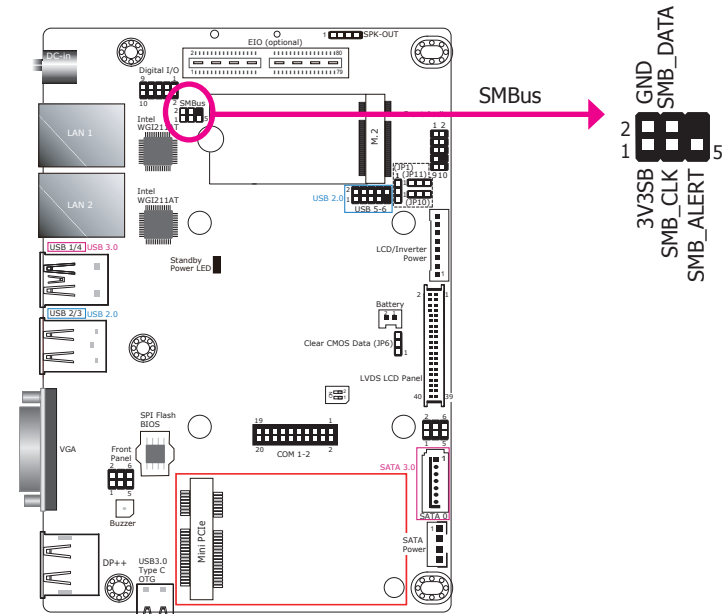

The SMBus (System Management Bus) connector is used to connect SMBus devices. It is a multiple device bus that allows multiple chips to connect to the same bus and enable each one to act as a master by initiating data transfer.

## Chapter 6 - Mounting Options

### Wall Mount

**Note:**

The system unit used in the following illustrations may not resemble the actual one. These illustrations are for reference only.

The wall mount kit includes the following:

- 2 wall mount brackets
- Bracket screws

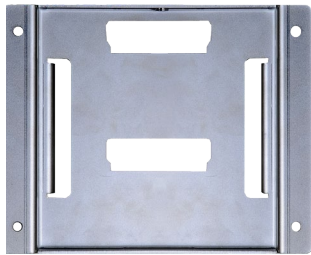

Wall mount bracket 1

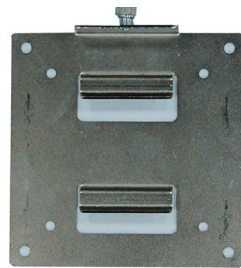

Wall mount bracket 2

1. Before starting any installation procedure, attach the poron foam to the Panel PC.

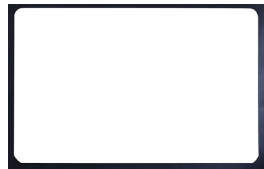

Poron foam

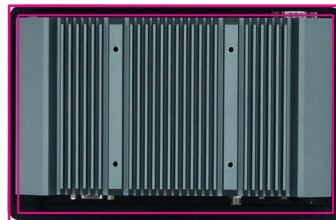

2. Select a place on the wall where you will mount the Panel PC.
3. Use the provided mounting screws to attach "wall mount bracket 1" to the wall.

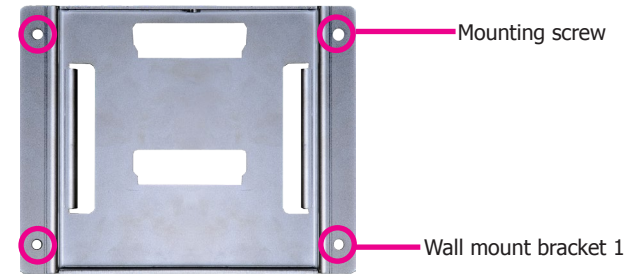

4. Attach the other bracket (wall mount bracket 2) to the rear of the Panel PC.

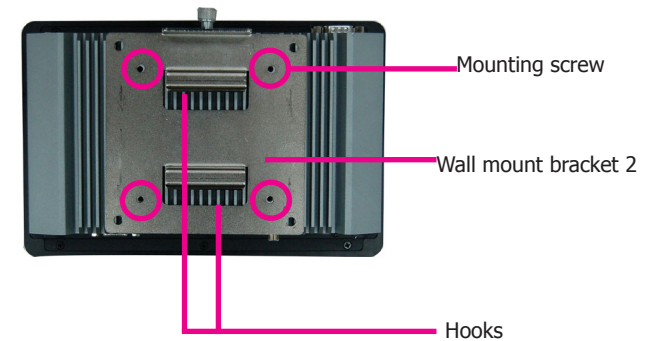

5. Slide the Panel PC to "wall mount bracket 1" to attach the two brackets with the hooks. Then tighten the screw to secure the assembly in place.

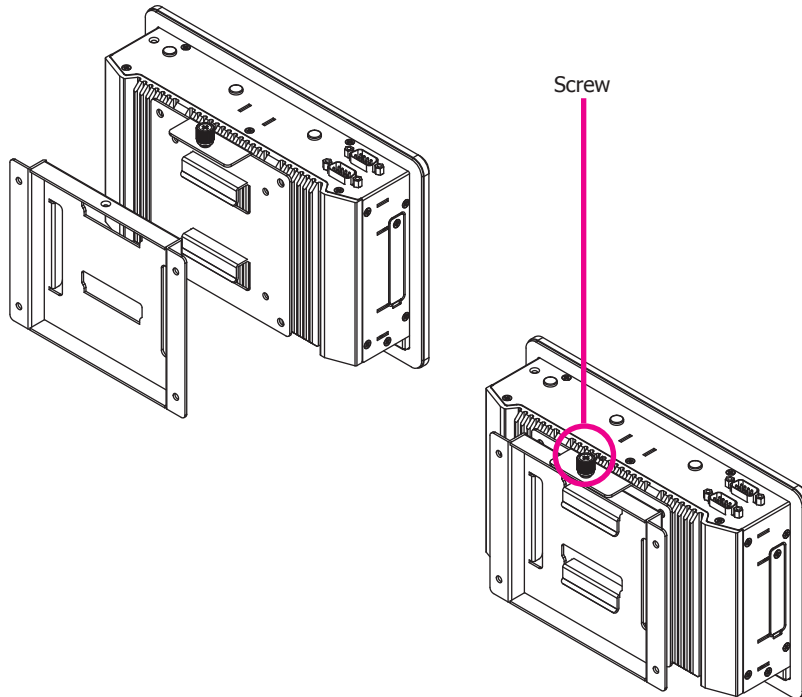

## Panel Mount



### Note:

The system unit used in the following illustrations may not resemble the actual one. These illustrations are for reference only.

The panel mounting kit includes the following:

- 6 mounting clamps



1. Before starting any installation procedures, attach the poron foam to the Panel PC.

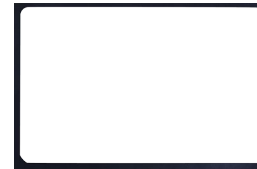

Poron foam

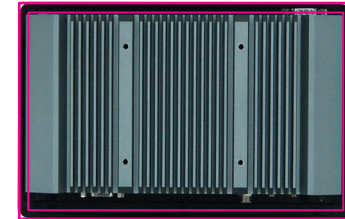

2. Select a place on the panel (or wall) where you will mount the Panel PC.
3. Cut out a shape on the panel that corresponds to the Panel PC's rear dimensions (210.5mm x 132.2mm) and ensure that the Panel PC can be fitted into the panel properly.

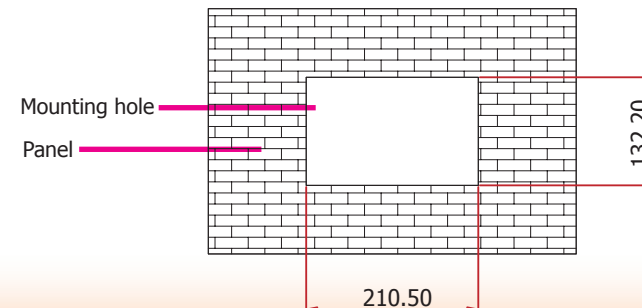

4. Insert the Panel PC from the outside surface of the panel into the mounting hole until it is properly fitted against the panel.
5. Position the mounting clamps along the rear edges of the Panel PC and insert them into the slits around the Panel PC.

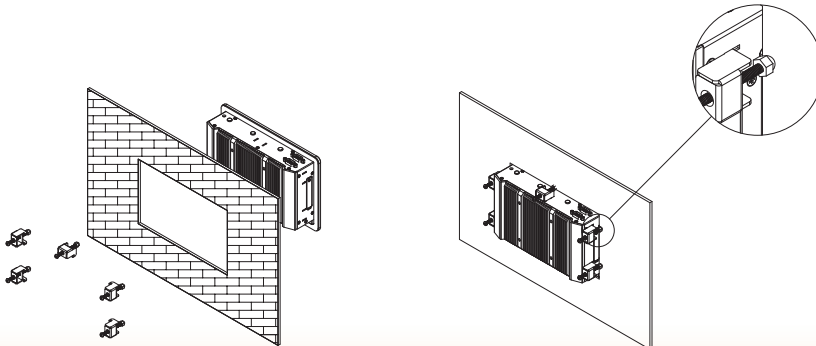

6. The first and second clamps must be positioned and secured diagonally prior to mounting the rest of the clamps. Tighten the clamp's screw using an electric screwdriver by pressing the white plastic cap onto the back of the panel. The illustration below shows that all clamps are properly mounted.

**Note:**

The flat panel thickness is less than 5mm.

## Chapter 7 - BIOS Setup

### Overview

The BIOS is a program that takes care of the basic level of communication between the CPU and peripherals. It contains codes for various advanced features found in this system board. The BIOS allows you to configure the system and save the configuration in a battery-backed CMOS so that the data retains even when the power is off. In general, the information stored in the CMOS RAM of the EEPROM will stay unchanged unless a configuration change has been made such as a hard drive replaced or a device added.

It is possible that the CMOS battery will fail causing CMOS data loss. If this happens, you need to install a new CMOS battery and reconfigure the BIOS settings.



**Note:**

The BIOS is constantly updated to improve the performance of the system board; therefore the BIOS screens in this chapter may not appear the same as the actual one. These screens are for reference purpose only.

### Default Configuration

Most of the configuration settings are either predefined according to the Load Optimal Defaults settings which are stored in the BIOS or are automatically detected and configured without requiring any actions. There are a few settings that you may need to change depending on your system configuration.

### Entering the BIOS Setup Utility

The BIOS Setup Utility can only be operated from the keyboard and all commands are keyboard commands. The commands are available at the right side of each setup screen.

The BIOS Setup Utility does not require an operating system to run. After you power up the system, the BIOS message appears on the screen and the memory count begins. After the memory test, the message "Press DEL to run setup" will appear on the screen. If the message disappears before you respond, restart the system or press the "Reset" button. You may also restart the system by pressing the <Ctrl> <Alt> and <Del> keys simultaneously.

### Legends

Keys	Function
Right and Left arrows	Moves the highlight left or right to select a menu.
Up and Down arrows	Moves the highlight up or down between submenu or fields.
<Esc>	Exit to the BIOS Setup Utility.
+ (plus key)	Scrolls forward through the values or options of the highlighted field.
- (minus key)	Scrolls backward through the values or options of the highlighted field.
<F1>	Displays general help
<F2>	Pervious values
<F3>	Optimized defaults
<F4>	Saves and resets the setup program.
<Enter>	Press <Enter> to enter the highlighted submenu.

### Scroll Bar

When a scroll bar appears to the right of the setup screen, it indicates that there are more available fields not shown on the screen. Use the up and down arrow keys to scroll through all the available fields.

### Submenu

When "►" appears on the left of a particular field, it indicates that a submenu which contains additional options are available for that field. To display the submenu, move the highlight to that field and press <Enter>.



## Insyde BIOS Setup Utility

### Main

The Main menu is the first screen that you will see when you enter the BIOS Setup Utility.

```

InsydeH20 Setup Utility                               Rev. 5.0
Main  Advanced Security Boot Exit

Intel(R) Celeron(R) CPU N3350 @ 1.10GHz
CPU Speed      1100 MHz
CPUID          0x506C9
L1 Data Cache  24 KB
L1 Instruction Cache 32 KB
L2 Cache       1024 KB
L3 Cache       0 KB
Number Of Processors 2 Core(s) / 2 Thread(s)
BXT SOC        B0 Stepping
Microcode Rev  0000002C

Total Memory   4096 MB
System Memory Speed 1600 MHz
SODIMM 0       4096 MB

TXE FW Version 3.1.50.2222
System Time    [14:39:28]

F1 Help      ↑/↓ Select Item  F5/F6 Change V F9 Setup Defaults
Esc Exit     +/+ Select Item    Enter  Select ▶ F10 Save and Exit
  
```

#### System Time

The time format is <hour>, <minute>, <second>. The time is based on the 24-hour military-time clock. For example, 1 p.m. is 13:00:00. Hour displays hours from 00 to 23. Minute displays minutes from 00 to 59. Second displays seconds from 00 to 59.

#### System Date

The date format is <month>, <date>, <year>. Month displays the month, from January to December. Date displays the date, from 1 to 31. Year displays the year, from 1980 to 2099.

## Advanced

The Advanced menu allows you to configure your system for basic operation. Some entries are defaults required by the system board, while others, if enabled, will improve the performance of your system or let you set some features according to your preference.



### Important:

Setting incorrect field values may cause the system to malfunction.

```

InsydeH20 Setup Utility                               Rev. 5.0
Main  Advanced Security Boot Exit

▶ACPI Configuration                               ACPI Configuration Setting
▶CPU Configuration
▶Video Configuration
▶Audio Configuration
▶SATA Configuration
▶USB Configuration
▶PCI Express Configuration
▶Console Redirection
▶SIO FINTEK81803

F1 Help      ↑/↓ Select Item  F5/F6 Change V F9 Setup Defaults
Esc Exit     +/+ Select Item    Enter  Select ▶ F10 Save and Exit
  
```

## ACPI Configuration

This section configures system ACPI parameters.

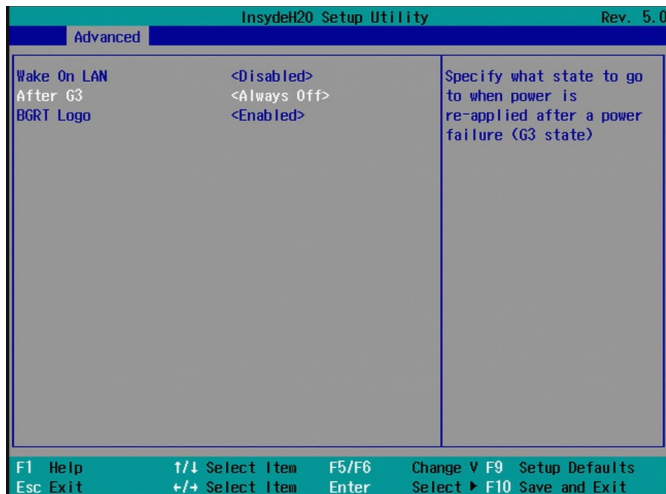

### Wake on LAN

Enable or disable WOL (wake-on-LAN) to wake the system through an Ethernet adapter.

### After G3

Specify which state the system should be in when power is re-applied after a power failure (G3, the mechanical-off, state).

**Always On** The system is powered on.

**Always Off** The system is powered off.

### BGRT Logo

Enable or disable the display of an operating system logo or image during boot using the BGRT (Boot Graphics Resource Table) mechanism.

## CPU Configuration

This section configures the CPU.

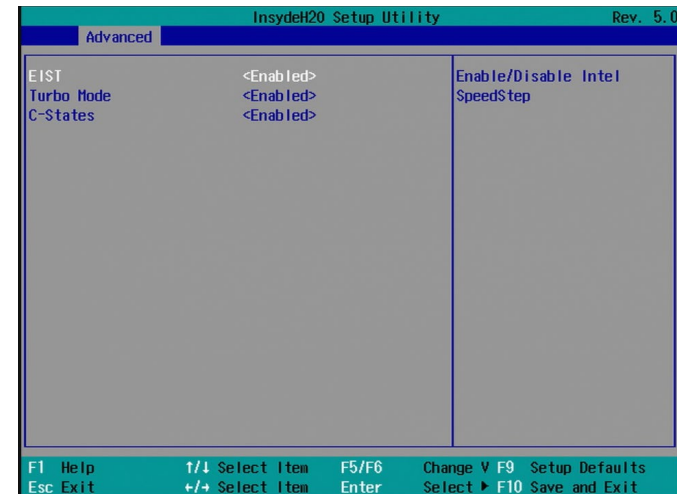

### EIST

Enable or disable the Enhanced Intel® SpeedStep® Technology, which helps optimize the balance between system's power consumption and performance. After it is enabled in the BIOS, you can take advantage of its offering by setting power schemes from the operating system's power options.

### Turbo Mode

Enable or disable processor turbo mode, which allows the processor core to automatically run faster than the base frequency by taking advantage of thermal and power headroom. Note this option is not available on the Core™ i3 processor.

### C-States

Enable or disable CPU power management. It allows the CPU to go to C states when it's not 100% utilized.

## Video Configuration

This section configures the video settings.

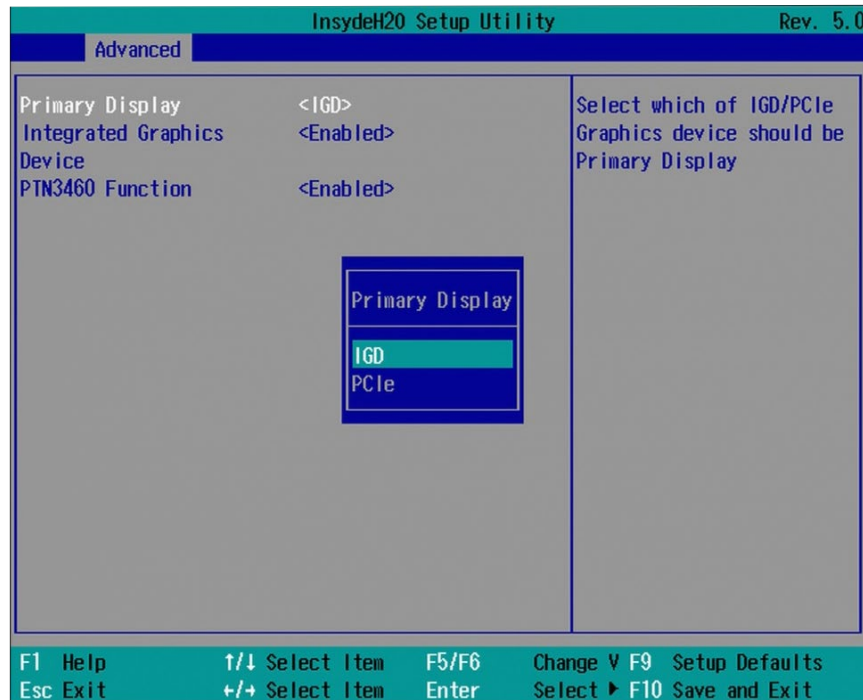

### Primary Display

Select the primary display for the system from the following options:

**IGD:** integrated graphics devices

**PCIe:** PCIe graphics devices

### Integrated Graphics Device

Enable, disable or automatically detect the integrated graphics device.

### PTN3460 Function

Enable or disable the PTN3460 LCD features. If enabled, the LCD panel type and the panel color depth options will be shown.

### LCD Panel Type

Select the type of LCD panel connected to the system's LCD connector. Please check the specification of your LCD monitor.

### Panel Color Depth

Select the LCD panel color depth: 18 bit, 24 bit, 36 bit, and 48 bit.

## Audio Configuration

This section configures the audio settings.

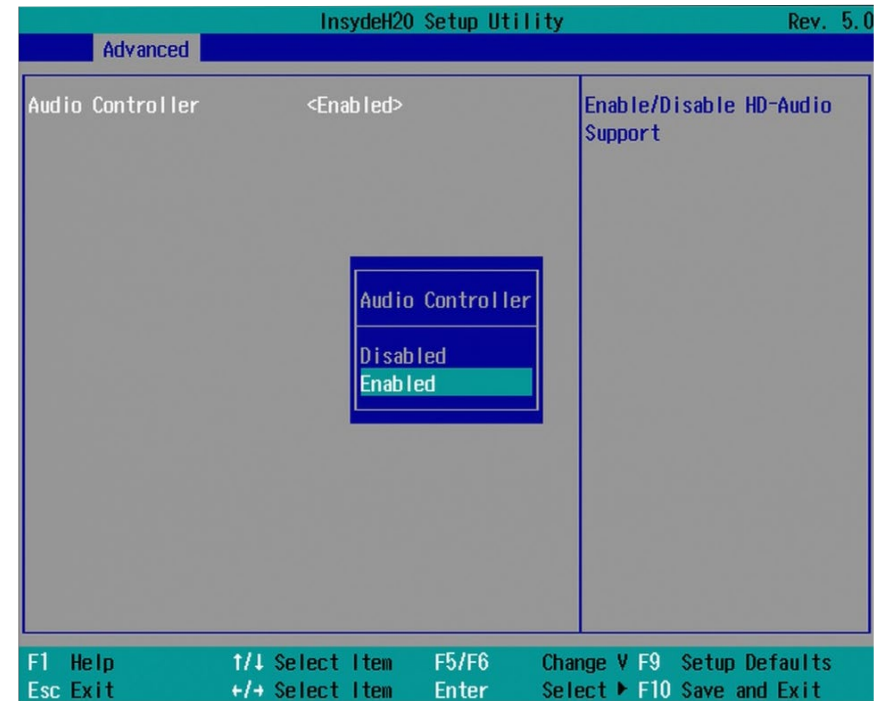

### HD Audio

Control the detection of the high-definition audio devices.

#### Disabled

High-definition audio devices will be unconditionally disabled.

#### Enabled

High-definition audio devices will be unconditionally enabled.

#### Auto

High-definition audio devices will be enabled if present and disabled otherwise.

## SATA Configuration

This section configures SATA devices. It also shows the information about the installed SATA drives.

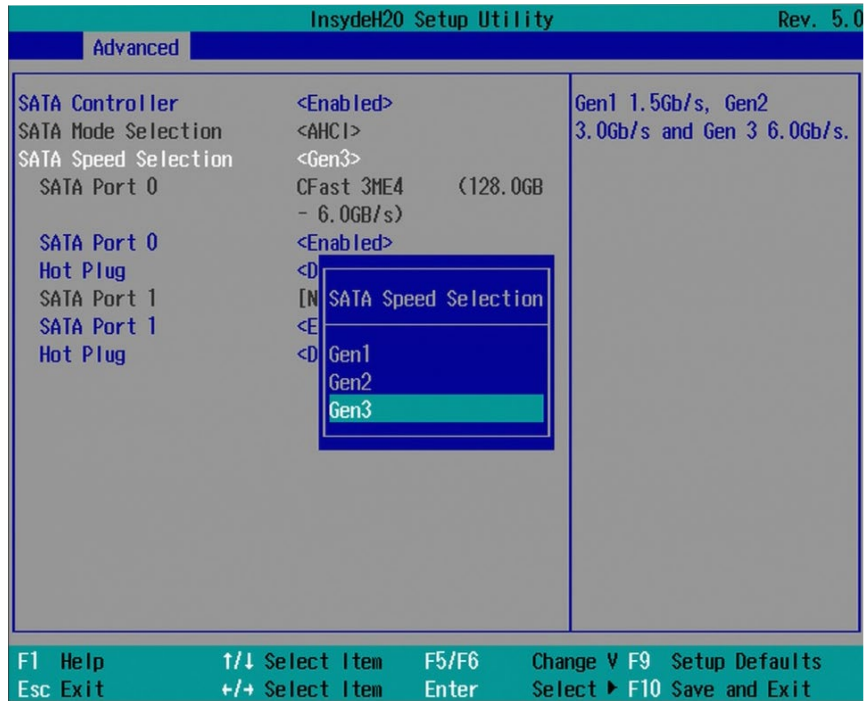

### SATA Speed

Select Serial ATA device speed from these options: Gen1 (1.5 Gbit/s), Gen2 (3 Gbit/s) or Gen 3 (6 Gbit/s).

### SATA Mode Selection

The mode selection determines how the SATA controller(s) operates.

### AHCI Mode

This option allows the Serial ATA devices to use AHCI (Advanced Host Controller Interface).

### Serial ATA Port 0 and 1 and Hot Plug

Enable or disable each Serial ATA port and its hot plug function.

SATA Port 0: It controls the signal of the CFast card slot.

SATA Port 1: It controls the signal of the M.2 slot.

### SATA Controller

Enable or disable the Serial ATA controller.

## USB Configuration

This section configures the parameters of USB devices.

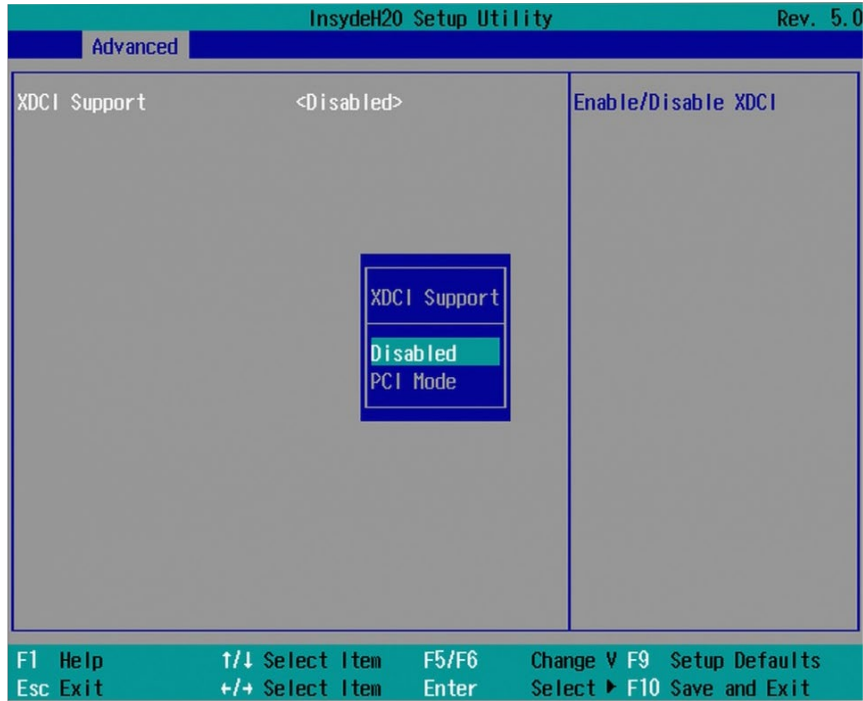

### XDCI Support

Enable or disable xDCI device (Extensible Device Controller Interface) to enable or disable the USB OTG device on the board.

## PCI Express Configuration

This section configures the settings of PCI Express root ports.

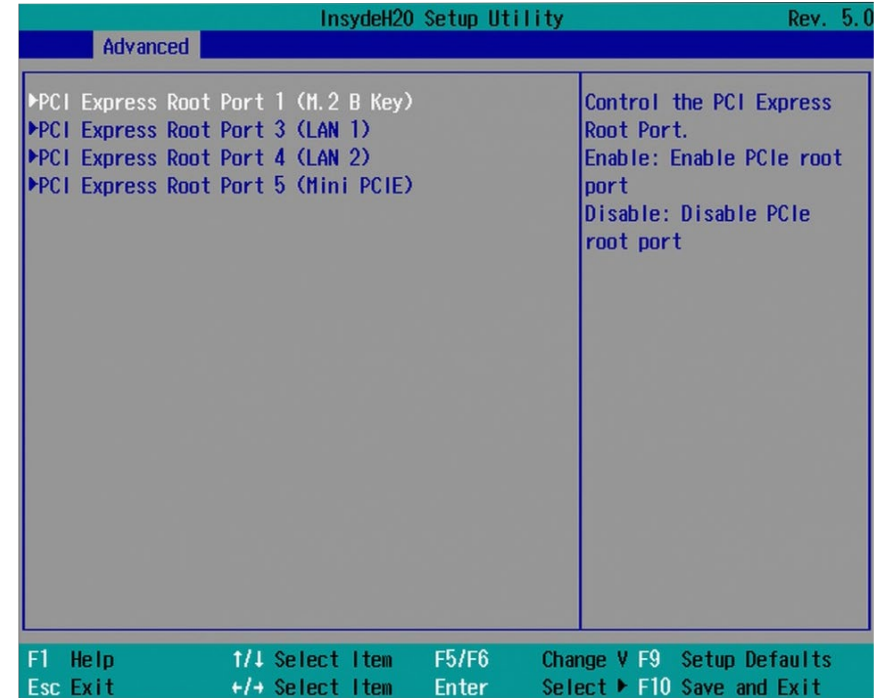

### PCI Express Root Port 1

Controls the PCIe signal of the M.2 slot.

### PCI Express Root Port 3

Controls the PCIe signal of LAN Port 1.

### PCI Express Root Port 4

Controls the PCIe signal of LAN Port 2.

### PCI Express Root Port 5

Controls the PCIe signal of Mini PCIe slot.

Press "Enter" to enter the configurations for each PCIe root port as shown on the next page.

### PCI Express Configuration

This section configures the settings of PCI Express root ports.

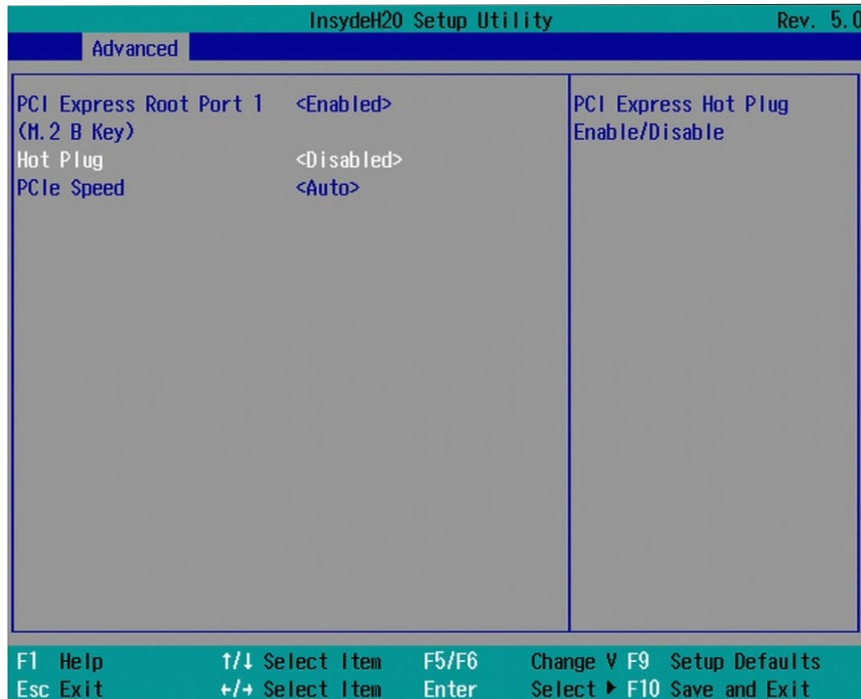

#### PCI Express Root Port

Enable or disable each PCI Express root port.

#### Hot Plug

Enable or disable the hot plug function.

#### PCIe Speed

Select the speed of the PCI Express Root Port: Auto, Gen1 (2.5 GT/s) or Gen2 (5 GT/s).

### Console Redirection

Console redirection lets you monitor and control the system from a remote station by re-directing the host screen output through a serial port.

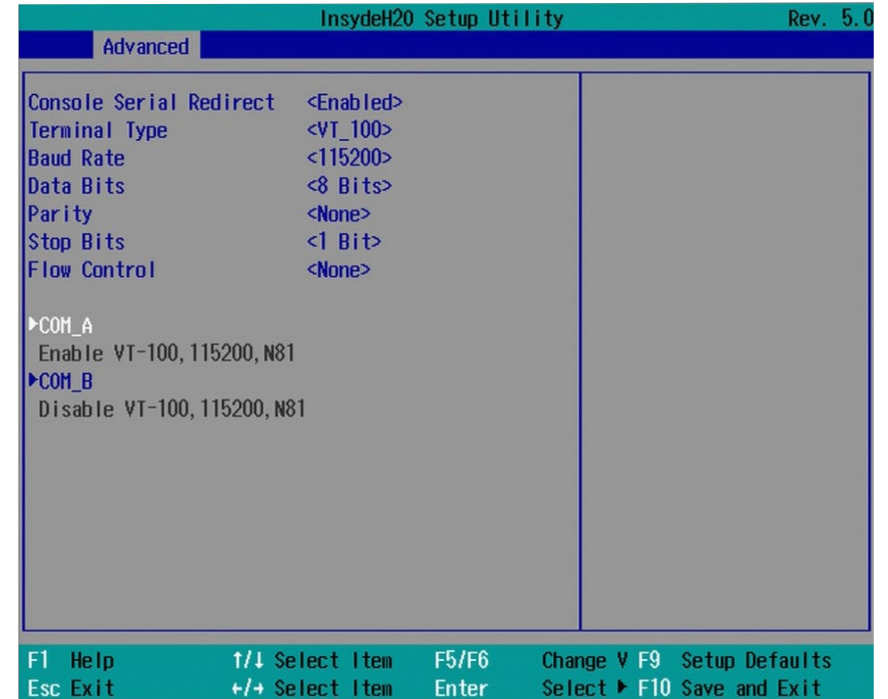

#### Console Serial Redirect

Enable or disable the console redirection function. (The default is disabled.) If you select to enable it, please configure the following parameters for serial communication between the system and a remote station:

Terminal type: VT\_100, VT\_100+, VT\_UTF8, or PC\_ANSI.

Baud rate: 115200, 57600, 38400, 19200, or 9600.

Data bits: 8 bits or 7 bits.

Parity: None, Even or Odd.

Stop bits: 1 bit or 2 bits.

Flow control: None, RTS/CTS or XON/XOFF

This is the global setting for all of the designated serial ports for console redirection.

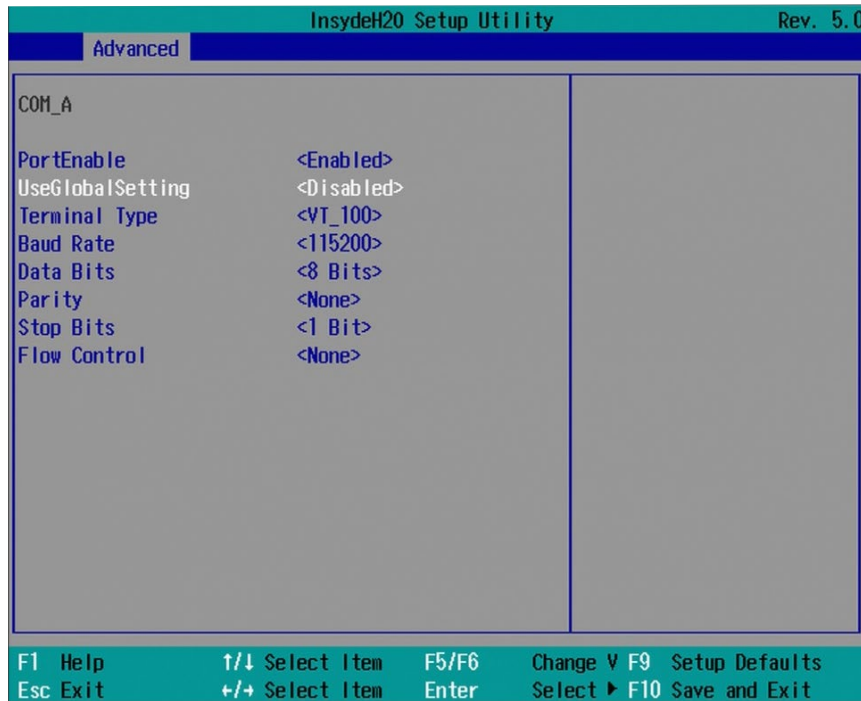

### COM A and COM B

Enable or disable the serial redirection function for each of the serial ports on the system. And configure the serial communication parameters to be used between the system and a remote station.

### UseGlobalSetting

Choose to use the pre-configured global settings from the previous menu or configure a different setting for each serial port.

### Super I/O

Console redirection lets you monitor and control the system from a remote station by re-directing the host screen output through a serial port.

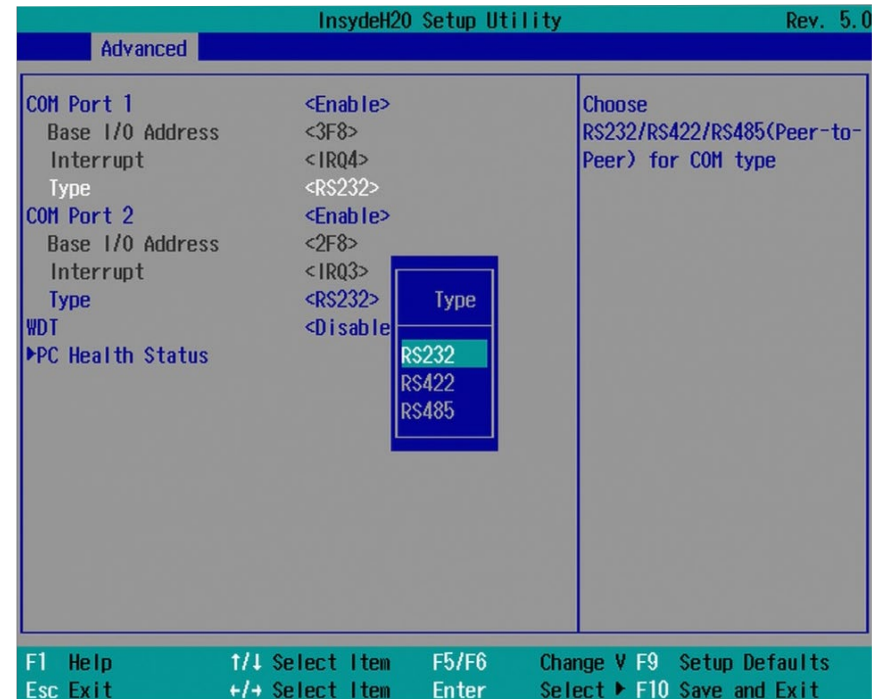

### COM Port 1 and COM Port 2

Enable or disable each serial port.

**Disable** Disable this serial port.

**Enable** Enable this serial port.

It also shows the Base I/O address and the assigned interrupt number.

### Type

Choose RS232, RS422 or RS485 (Peer-to-Peer) for the serial port type for COM port 1 and 2.

### WDT

Enable or disable the watchdog function. A counter will appear if you select to enable WDT. Input any value between 1 and 255.

## PC Health Status

This section d

tatus.

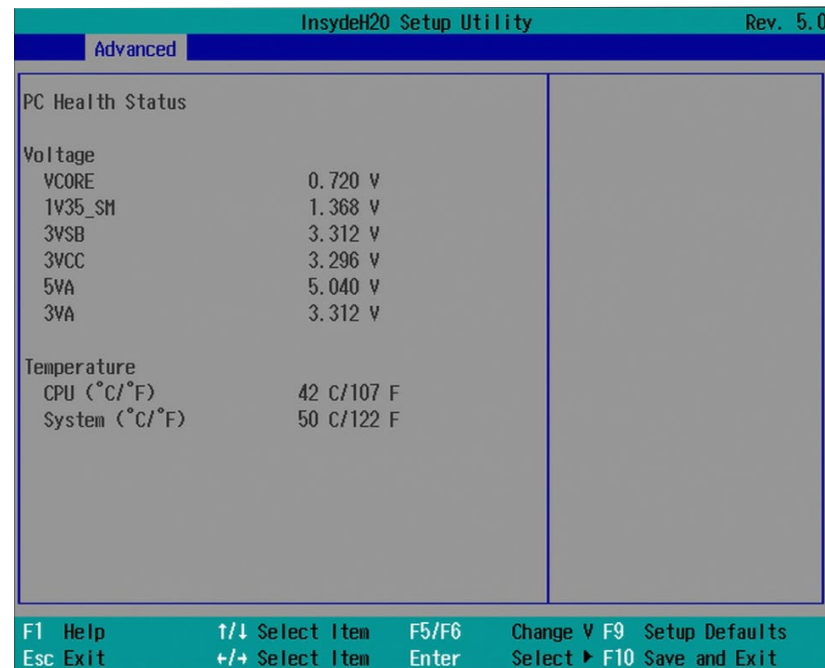

## Security

This section configures the Trusted Platform Module (TPM) function.

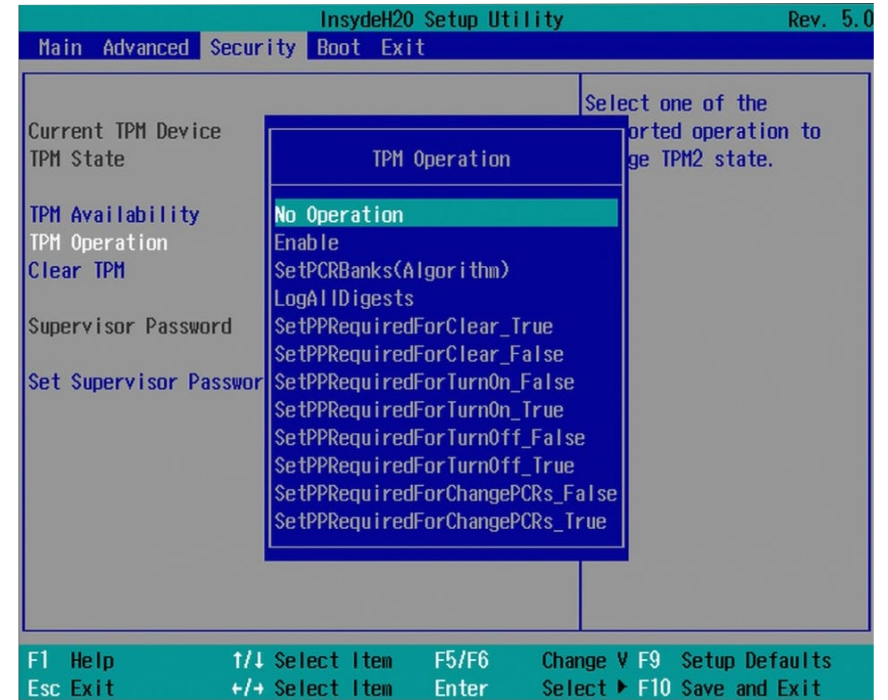

### TPM Availability

Show or hide TPM availability and its configurations.

### TPM Operation

Select one of the supported operation to change the TPM2 state.

### Clear TPM

Remove all TPM ownership contents.

### Set Supervisor Password

Set the administrative password for entering the BIOS utility or upon the entering of the power-on self-test (POST) process. The length of the password must be greater than 1 character and less than or equal to 10 characters.

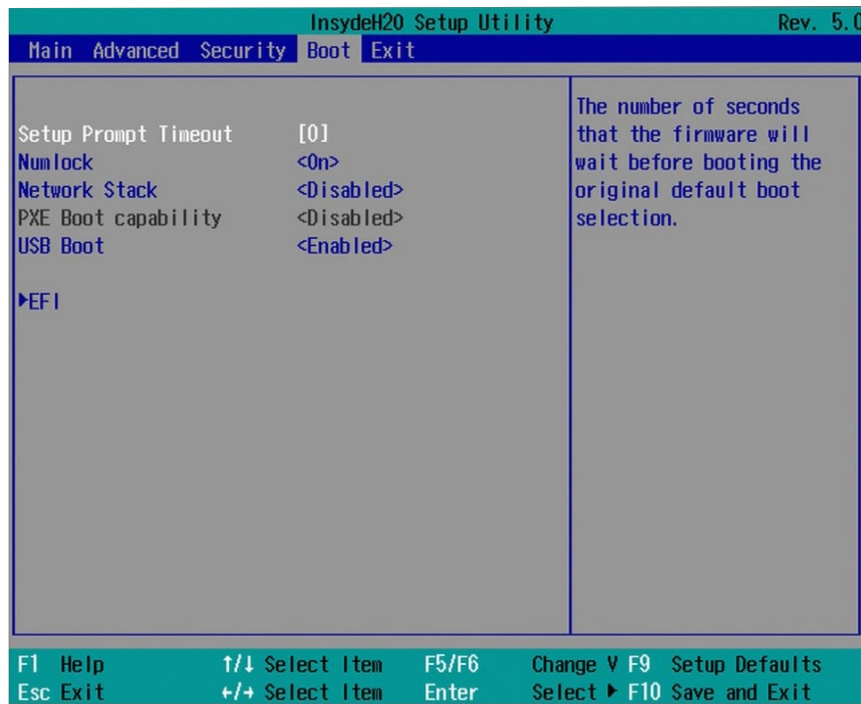

## Boot

**Note:**

The BIOS supports only UEFI boot but not legacy.

**EFI**

Enter this menu to select the priority of the UEFI boot devices. Use the "+" key to move an item up or the "-" key to move an item down. The one on the top of the list has the highest priority.

**Setup Prompt Timeout**

Select the number of seconds the system will wait before booting the original firmware selection.

**NumLock State**

This allows you to determine the default state of the numeric keypad at boot. By default, the system boots up with Num Lock on. When set to Off, the function of the numeric keypad is the arrow keys.

**Network Stack**

Enable or disable network stack. It supports the operation of these functions or software: Windows 8 BitLocker Network Unlock and UEFI IPv4/IPv6 PXE.

**PXE Boot Capability**

Enable or disable Preboot eXecution Environment (PXE) boot through the Ethernet. This function can only be enabled if the Network Stack support is enabled.

**USB Boot**

Enable or disable USB boot from a flash drive.

## Exit

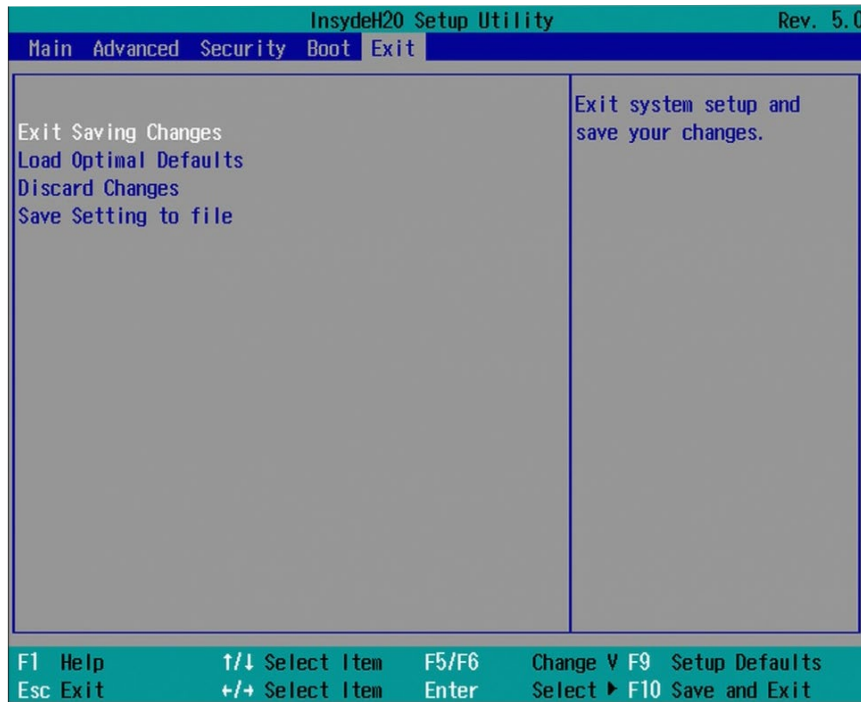

### Exit Saving Changes

Select this field and press <Enter> to exit BIOS setup and save your changes.

### Load Optimal Defaults

Select this field and press <Enter> to load the optimal defaults.

### Discard Changes

Select this field and press <Enter> to exit the BIOS setup without saving your changes.

### Save Setting to file

Select this option to save BIOS configuration settings to a USB drive. The operation will fail if there aren't any USB devices detected on the system. The saved configuration will have the DSF file extension and can be used for restoration.

### Restore Setting from file

Select this option to restore BIOS configuration settings from a USB drive. Note that this option will not be available if there aren't any USB devices detected on the system.

## Updating the BIOS

To update the BIOS, you will need the new BIOS file and a flash utility. Please contact technical support or your sales representative for the files and specific instructions about how to update BIOS with the flash utility.

When you download the given BIOS file, you may find a BIOS flash utility attached with the BIOS file. This is the utility for performing BIOS updating procedure. For your convenience, we will also provide you with an auto-execution file in the BIOS file downloaded. This auto-execution file will bring you directly to the flash utility menu soon after system boots up and finishes running the boot files in your boot disk.

```

Read file successfully. (path="platform.ini")

Information
Please do not remove the AC power

Insyde H20FFT (Flash Firmware Tool) Version (SEG) 100.00.08.10
Copyright(c) 2012 - 2016, Insyde Software Corp. All Rights Reserved.

Initializing
Current BIOS Model name: AL551
New BIOS Model name: AL551

Current BIOS version: 68.08A
New BIOS version: 68.08A

Updating Block at FFFF000h
0%      25%      50%      75%      100%
|-----|-----|-----|-----|
C:\SU25x>_

```

## Notice: BIOS SPI ROM

1. The Intel® Management Engine has already been integrated into this system board. Due to safety concerns, the BIOS (SPI ROM) chip cannot be removed from this system board and used on another system board of the same model.
2. The BIOS (SPI ROM) on this system board must be the original equipment from the factory and cannot be used to replace one which has been utilized on other system boards.
3. If you do not follow the methods above, the Intel® Management Engine will not be updated and will cease to be effective.

### Note:



- a. You can take advantage of flash tools to update the default configuration of the BIOS (SPI ROM) to the latest version anytime.
- b. When the BIOS IC needs to be replaced, you have to populate it properly onto the system board after the EEPROM programmer has been burned and follow the technical person's instructions to confirm that the MAC address should be burned or not.

## Chapter 8 - Supported Software

The CD that came with the system board contains drivers, utilities and software applications required to enhance the performance of the system board.

Insert the CD into a CD-ROM drive. The auto-run screen (the Utility and Manual CD) will appear. If the "Auto-run" does not automatically start, please go directly to the root directory of the CD and double-click "Setup".

### Auto Run Page (For Windows 10)



## Intel Chipset Software Installation Utility

The Intel Chipset Device Software is used for updating Windows® INF files so that the Intel chipset can be recognized and configured properly in the system.

To install the utility, click "Intel Chipset Software Installation Utility" in the main menu.

1. Setup is ready to install the utility. Click "Next" to continue.

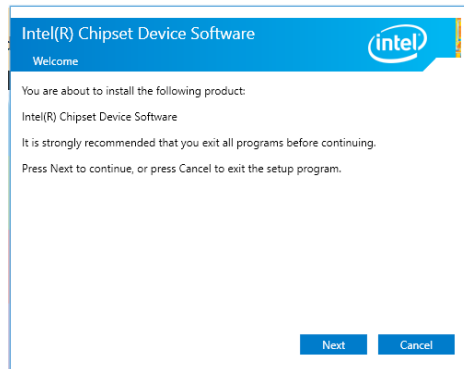

2. Read the license agreement, then click "Accept" if you accept the terms and conditions.

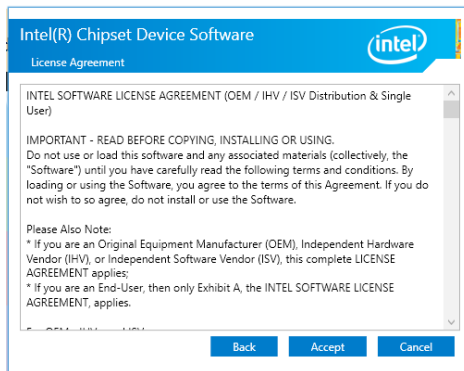

3. Go through the readme document for more installation tips then click "Install."

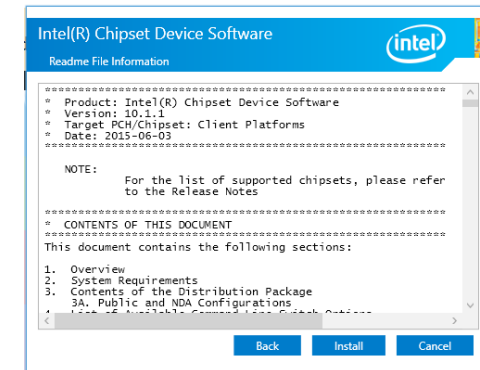

4. After the installation is complete, click "Restart Now".

Restarting the system will allow the new software installation to take effect.



## Intel Graphics Drivers

To install the driver, click "Intel Graphics Drivers" in the main menu.

1. Setup is now ready to install the graphics driver. Click "Next" to continue.

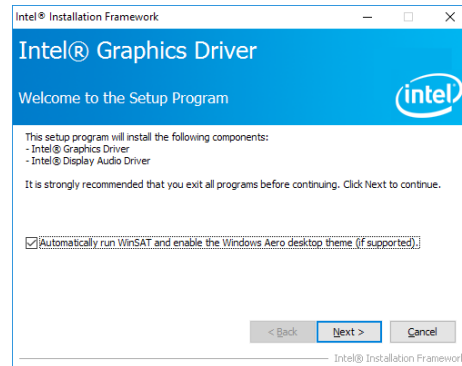

By default, the "Automatically run WinSAT and enable the Windows Aero desktop theme" is enabled. When this is enabled and the system reboots after driver installation, the screen will turn blank for 1 to 2 minutes (while WinSAT is running) before the Windows 7/ Windows 8 desktop appears. The "blank screen" period is the time Windows is testing the graphics performance.

We recommend that you skip this process by disabling this function and click "Next".

2. Read the license agreement, then click "Yes" if you accept the terms and conditions.

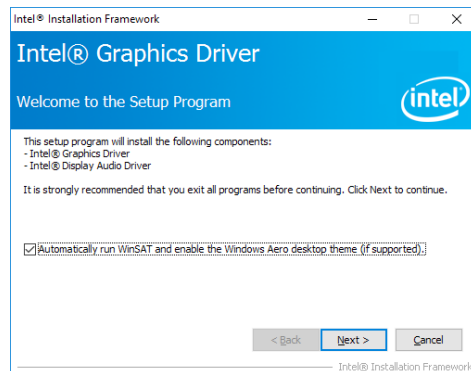

3. Go through the Readme document for system requirements and installation tips, then click "Next".

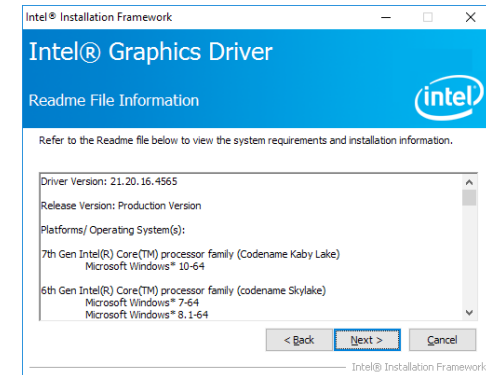

4. Setup is now installing the driver. Click "Next" to continue.

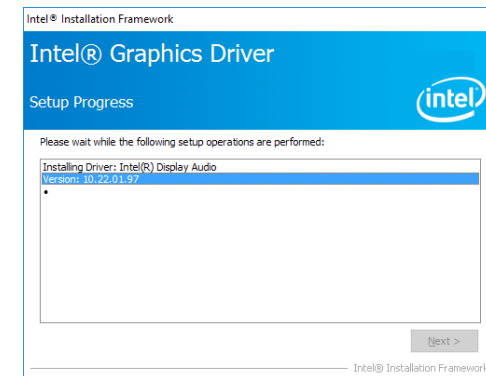

5. Click "Yes, I want to restart this computer now", then click "Finish" to exit the setup program.

Restarting the system will allow the new software installation to take effect.

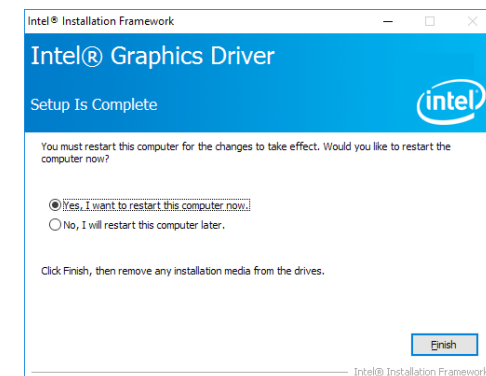

## Intel LAN Drivers

To install the driver, click "LAN Drivers" in the main menu.

1. Setup is ready to install the driver. Click "Next" to continue.

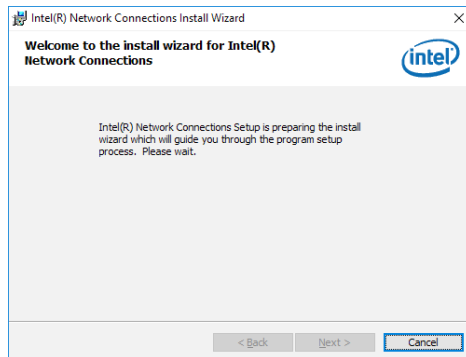

2. Click "I accept the terms in the license agreement" if you accept the terms and conditions, then click "Next".

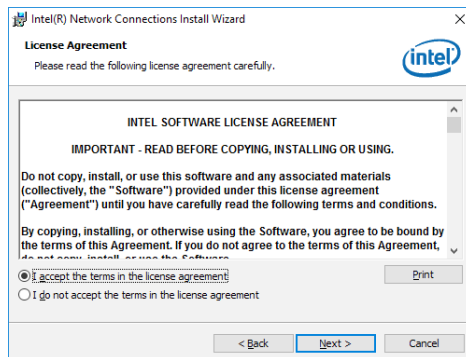

3. Select the program features you want to install then click "Next" to continue.

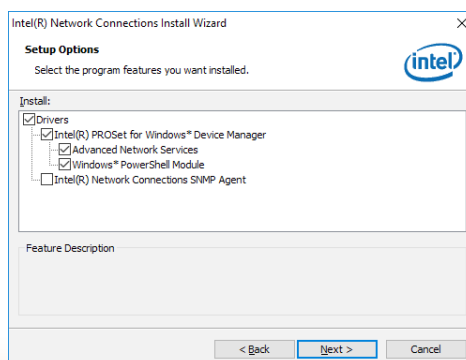

4. Click "Install" to begin the installation.

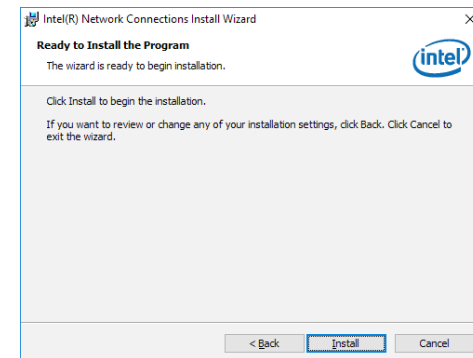

5. After the installation is complete, click "Finish" to exit the setup program.

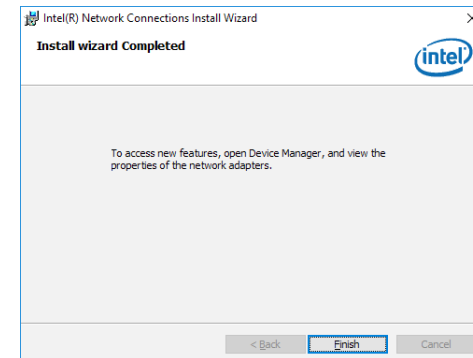

## Intel Trusted Execution Engine Driver

To install the driver, click "Intel TXE Drivers" in the main menu.

1. Select "I accept the terms in the License Agreement", then click "Next."

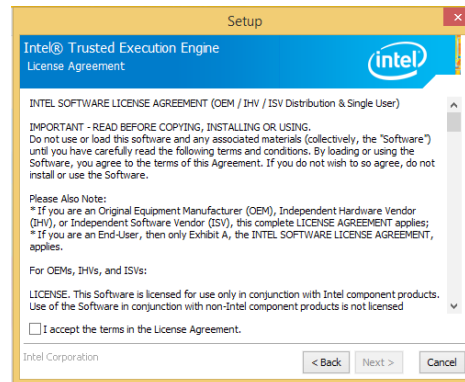

3. The screen displays the installation status in progress.

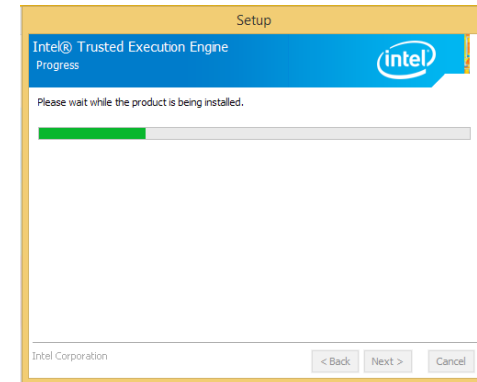

2. The screen shows the components that will be installed. Click "Next" to continue.

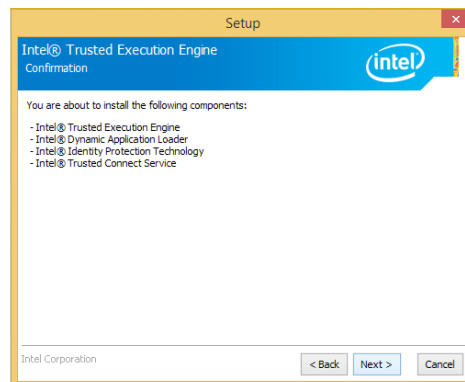

4. Click "Finish" when the installation is complete.

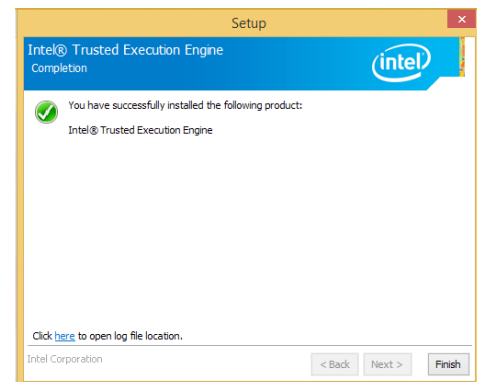



## Realtek Audio Drivers

To install the driver, click "Realtek Audio Drivers" in the main menu.

1. Setup is now ready to install the audio driver. Click "Next" to start the installation.

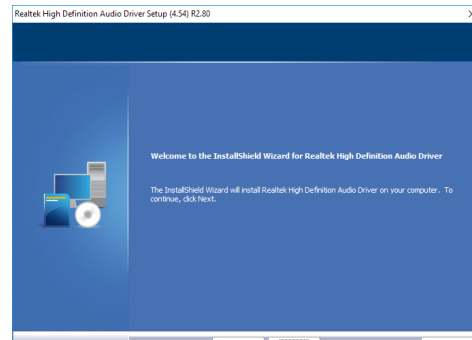

2. Follow the on-screen instructions to proceed with the setup program. Click "Next" each time you finish a step.

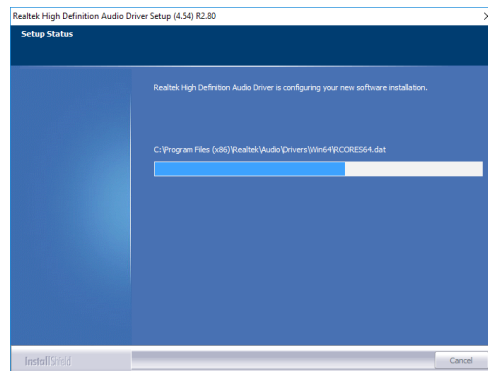

3. Click "Yes, I want to restart my computer now" then click "Finish."

Restarting the system will allow the new software installation to take effect.

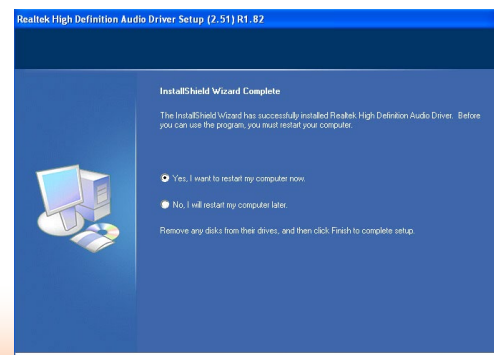

## IO Driver

To install the Intel® Serial IO driver, click "IO Driver" in the main menu.

1. Setup is ready to install the driver. Click "Next" to continue.

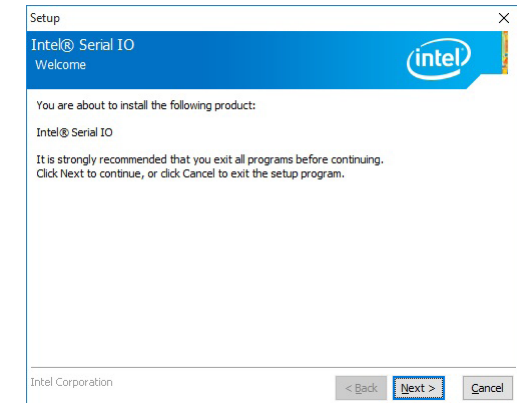

2. Read the license agreement carefully. Click "I accept the terms in the License Agreement" if you agree with the terms in the agreement, then click "Next".

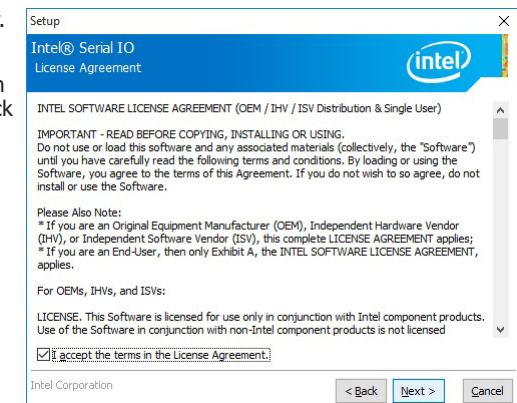

3. Read the file information for installation information, then click "Next".

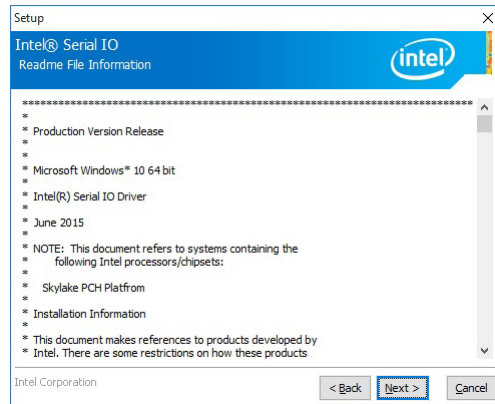

5. Setup is now installing the driver.

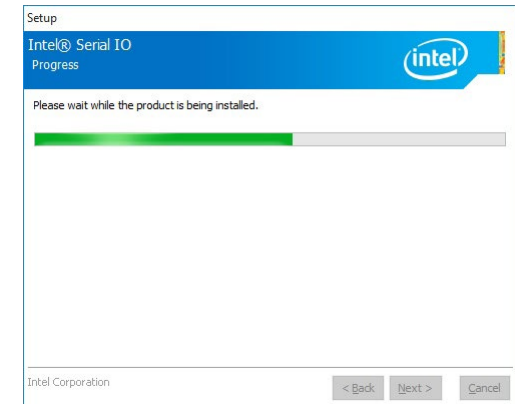

4. Setup is ready to install the driver. Click "Next" to begin the installation.

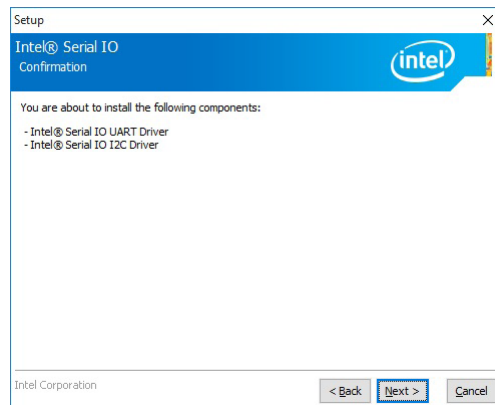

6. Click "Finish" to exit setup.



## eGalaxTouch Touch Panel Driver

To install this driver, click “eGalaxTouch Touch Screen Driver” in the main menu.

1. Setup is ready to install the driver.  
Click “Next” to continue.

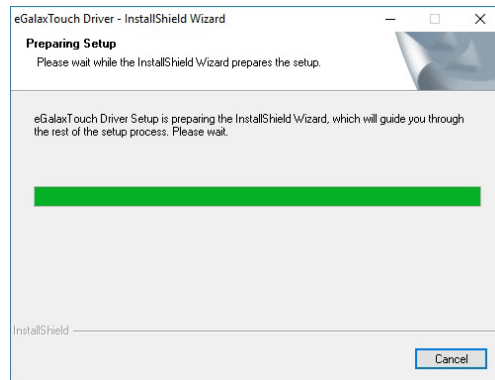

3. Setup detects that an extra RS232 interface driver needs to be installed for the eGalaxTouch controller. Please check to install the driver.

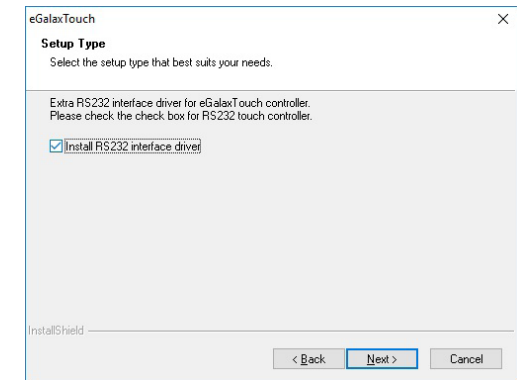

2. Read the license agreement carefully. Click “I accept the terms of the license agreement” if you agree with the terms in the agreement, then click “Next”.

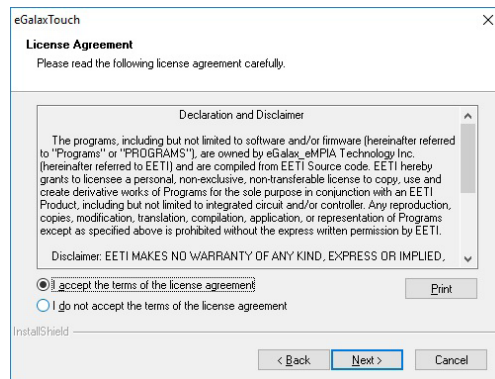

4. Select the setup type that best suits your needs.

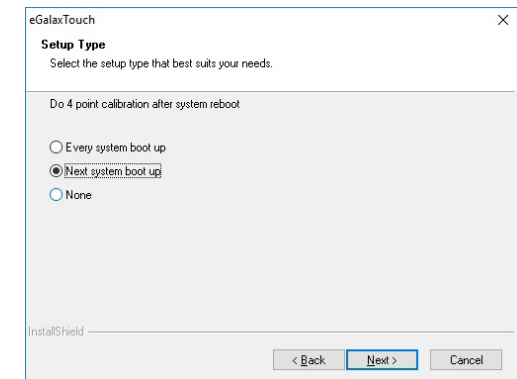

5. Select whether to support the multi-monitor system.

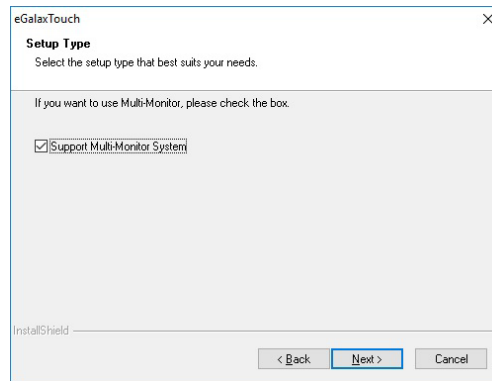

6. Select the installation folder. Follow the rest of the steps on the screen to complete the installation procedure.

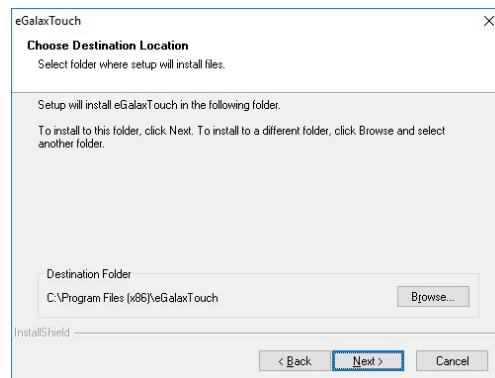

## Wi-Fi Driver

To install the Wi-Fi driver, click "WLAN Driver" in the main menu.

1. Select the language for the installation.

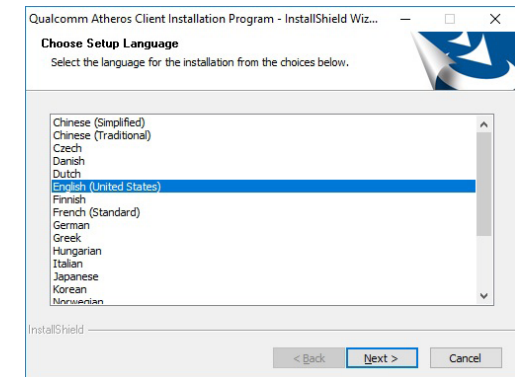

2. Setup is now ready to install the audio driver. Click "Next" to start the installation.

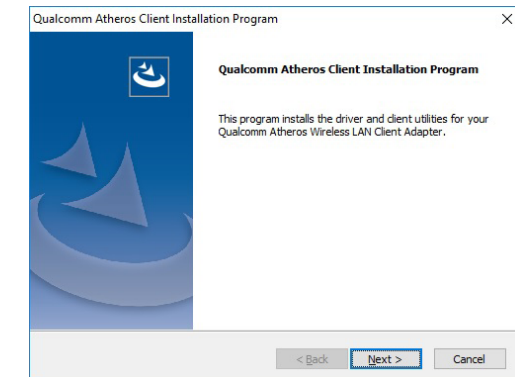

3. Read the license agreement carefully. Click "I accept the terms of the license agreement" if you agree with the terms in the agreement, then click "Next".

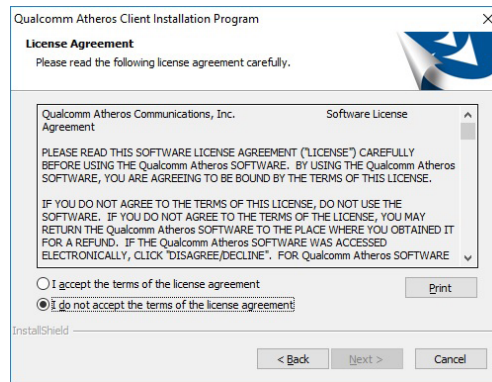

4. Click "Finish" to exit the installation wizard.

