



DT122-GH
Desktop Box IPC
User's Manual

Copyright

This publication contains information that is protected by copyright. No part of it may be reproduced in any form or by any means or used to make any transformation/adaptation without the prior written permission from the copyright holders.

This publication is provided for informational purposes only. The manufacturer makes no representations or warranties with respect to the contents or use of this manual and specifically disclaims any express or implied warranties of merchantability or fitness for any particular purpose. The user will assume the entire risk of the use or the results of the use of this document. Further, the manufacturer reserves the right to revise this publication and make changes to its contents at any time, without obligation to notify any person or entity of such revisions or changes.

Changes after the publication's first release will be based on the product's revision. The website will always provide the most updated information.

© 2019. All Rights Reserved.

Trademarks

Product names or trademarks appearing in this manual are for identification purpose only and are the properties of the respective owners.

FCC and DOC Statement on Class A

This equipment has been tested and found to comply with the limits for a Class A digital device, pursuant to Part 15 of the FCC rules. These limits are designed to provide reasonable protection against harmful interference when the equipment is operated in a residential installation. This equipment generates, uses and can radiate radio frequency energy and, if not installed and used in accordance with the instruction manual, may cause harmful interference to radio communications. However, there is no guarantee that interference will not occur in a particular installation. If this equipment does cause harmful interference to radio or television reception, which can be determined by turning the equipment off and on, the user is encouraged to try to correct the interference by one or more of the following measures:

- Reorient or relocate the receiving antenna.
- Increase the separation between the equipment and the receiver.
- Connect the equipment into an outlet on a circuit different from that to which the receiver is connected.
- Consult the dealer or an experienced radio TV technician for help.

Notice:

1. The changes or modifications not expressly approved by the party responsible for compliance could void the user's authority to operate the equipment.
2. Shielded interface cables must be used in order to comply with the emission limits.

Table of Contents

Copyright	2	Chapter 7 - BIOS Setup	28
Trademarks	2	Chapter 8 - Supported Software	44
FCC and DOC Statement on Class A.....	2		
About this Manual	4		
Warranty	4		
Static Electricity Precautions.....	4		
Safety Measures.....	4		
Safety Precautions	5		
About the Package	5		
Before Using the System	5		
Chapter 1 - Introduction	6		
Overview.....	6		
Key Features	6		
Specifications	7		
Getting to Know the DT122-GH.....	8		
Mechanical Dimensions.....	9		
Chapter 3 - Installing Devices	11		
Opening the chassis.....	11		
Installing a 2.5" or 3.5" SATA Drive.....	12		
Installing an M.2 Module.....	13		
Installing a PCIe Expansion Card.....	14		
Chapter 4 - Jumper Settings.....	16		
Clear CMOS Data	16		
Auto Power-on Select.....	16		
COM2 RS232/Power Select	17		
COM2 RS232/422/485 Select	17		
SATA Ports Signal Select	18		
Chapter 6 - Mounting Options	26		

About this Manual

An electronic file of this manual can be obtained from the DFI website at www.dfi.com. To download the user's manual from our website, please go to "Support" > "Download Center." On the Download Center page, select your product or type the model name and click "Search" to find all technical documents including the user's manual for a specific product.

Warranty

1. Warranty does not cover damages or failures that arised from misuse of the product, inability to use the product, unauthorized replacement or alteration of components and product specifications.
2. The warranty is void if the product has been subjected to physical abuse, improper installation, modification, accidents or unauthorized repair of the product.
3. Unless otherwise instructed in this user's manual, the user may not, under any circumstances, attempt to perform service, adjustments or repairs on the product, whether in or out of warranty. It must be returned to the purchase point, factory or authorized service agency for all such work.
4. We will not be liable for any indirect, special, incidental or consequential damages to the product that has been modified or altered.

Static Electricity Precautions

It is quite easy to inadvertently damage your PC, system board, components or devices even before installing them in your system unit. Static electrical discharge can damage computer components without causing any signs of physical damage. You must take extra care in handling them to ensure against electrostatic build-up.

1. To prevent electrostatic build-up, leave the system board in its anti-static bag until you are ready to install it.
2. Wear an antistatic wrist strap.
3. Do all preparation work on a static-free surface.
4. Hold the device only by its edges. Be careful not to touch any of the components, contacts or connections.
5. Avoid touching the pins or contacts on all modules and connectors. Hold modules or connectors by their ends.



Important:

Electrostatic discharge (ESD) can damage your processor, disk drive and other components. Perform the upgrade instruction procedures described at an ESD workstation only. If such a station is not available, you can provide some ESD protection by wearing an antistatic wrist strap and attaching it to a metal part of the system chassis. If a wrist strap is unavailable, establish and maintain contact with the system chassis throughout any procedures requiring ESD protection.

Safety Measures

To avoid damage to the system:

- Use the correct AC input voltage range.

To reduce the risk of electric shock:

- Unplug the power cord before removing the system chassis cover for installation or servicing. After installation or servicing, cover the system chassis before plugging the power cord.

Battery:

- Danger of explosion if battery incorrectly replaced.
- Replace only with the same or equivalent type recommend by the manufacturer.
- Dispose of used batteries according to local ordinance.

Safety Precautions

- Use the correct DC input voltage range.
- Unplug the power cord before removing the system chassis cover for installation or servicing. After installation or servicing, cover the system chassis before plugging the power cord.
- Danger of explosion if battery incorrectly replaced.
- Replace only with the same or equivalent type recommend by the manufacturer.
- Dispose of used batteries according to local ordinance.
- Keep this system away from humidity.
- Place the system on a stable surface. Dropping it or letting it fall may cause damage.
- The openings on the system are for air ventilation to protect the system from overheating. DO NOT COVER THE OPENINGS.
- Place the power cord in such a way that it will not be stepped on. Do not place anything on top of the power cord. Use a power cord that has been approved for use with the system and that it matches the voltage and current marked on the system's electrical range label.
- If the system will not be used for a long time, disconnect it from the power source to avoid damage by transient overvoltage.
- If one of the following occurs, consult a service personnel:
 - The power cord or plug is damaged.
 - Liquid has penetrated the system.
 - The system has been exposed to moisture.
 - The system is not working properly.
 - The system dropped or is damaged.
 - The system has obvious signs of breakage.
- The unit uses a three-wire ground cable which is equipped with a third pin to ground the unit and prevent electric shock. Do not defeat the purpose of this pin. If your outlet does not support this kind of plug, contact your electrician to replace the outlet.
- Disconnect the system from the DC outlet before cleaning. Use a damp cloth. Do not use liquid or spray detergents for cleaning.

About the Package

The package contains the following items. If any of these items are missing or damaged, please contact your dealer or sales representative for assistance.

- DT122-GH system unit
- HDD drive bay kit
- Screw pack for M.2 installation

Optional Items

- Power Cord

The board and accessories in the package may not come similar to the information listed above. This may differ in accordance to the sales region or models in which it was sold. For more information about the standard package in your region, please contact your dealer or sales representative.

Before Using the System

Before powering-on the system, prepare the basic system components.

If you are installing the system board in a new system, you will need at least the following internal components.

- Memory module
- Storage devices such as hard disk drive, CD-ROM, etc.

You will also need external system peripherals you intend to use which will normally include at least a keyboard, a mouse and a video display monitor.

Chapter 1 - Introduction

Overview



Front View



Rear View

Key Features

Model Name	DT122-GH
Graphics	AMD® Ryzen™ Embedded V1000/R1000 series
Chipset	AMD® Radeon™ Vega Graphics
LAN	2 LAN ports
COM	2 COM ports (DB-9)
Displays	4 x DP++ (V1000), quad display 3 x DP++ (R1000), triple display
USB	2 USB 3.0 ports 2 USB 2.0 ports
Audio	Mic-in, Line-in & Line-out

Specifications

Processor System	AMD® Ryzen™ Embedded V1000 series AMD® Ryzen™ Embedded V1807, Quad Core, 2M Cache, 11 CU, 3.35GHz (3.8GHz), 35-54W AMD® Ryzen™ Embedded V1756, Quad Core, 2M Cache, 8 CU, 3.25GHz (3.6GHz), 35-54W AMD® Ryzen™ Embedded V1605, Quad Core, 2M Cache, 8 CU, 2.0GHz (3.6GHz), 12-25W AMD® Ryzen™ Embedded V1202, Dual Core, 1M Cache, 3 CU, 2.3GHz (3.2GHz), 12-25W AMD® Ryzen™ Embedded R1000 series
Memory	<ul style="list-style-type: none"> • 2 x 260-pin SODIMM up to 32GB • Dual Channel DDR4 3200MHz
Graphics	<ul style="list-style-type: none"> • AMD® Radeon™ Vega Graphics • OpenGL 5.0, DirectX 12, OpenCL 2.1 HW Decode: AVC/H.264, MPEG2, VC1/WMV9, JPEG/MJPEG, HEVC/H265, VP8, VP9 HW Encode: MPEG2, AVC/H264, JPEG, HEVC/H265, VP8, VP9 • Displays: 4 x DP++ (V1000) or 3x DP++ (R1000) • Supports resolution up to 4096x2160 @ 60Hz) • Supports quad or triple display
Storage	1 x 3.5" or 2 x 2.5" SATA 3.0 Drive Bay
Ethernet	2 x Realtek RTL8111HN Integrated 10/100/1000 Ethernet Controller
Expansion Slots	<ul style="list-style-type: none"> • 1 x PCIe or 1 x PCI expansion slot (through an optional riser card connected to the onboard PCIe x16 slot (x8 bandwidth with V1000, x4 bandwidth with R1000) • 1 x M.2 2280 slot (M Key, PCIe x4 with V1000; x2 signal with R1000)
Audio	Realtek ALC887-VD Audio Codec with 5.1 Channel
Power	<ul style="list-style-type: none"> • Power type - Single 12V DC (150W) • DC-in External Power Adapter (available upon request)
Cooling System	1 x System Fan 1 x CPU Fan

I/O Ports	<ul style="list-style-type: none"> • Front Panel - 1 Power button • Rear Panel - 2 x GbE (RJ-45) - 1 x RS-232/422/485 (DB-9) & 1 x RS-232 (DB-9) - 2 x USB 3.0 - 2 x USB 2.0 - 4 x DP++ (V1000) or 3 x DP++ (R1000) - Mic-in, line-in & line-out jack
Environment	<ul style="list-style-type: none"> • Temperature - Operating: 0°C~45°C, -40°C~60°C (V1404i only) - Storage: -40 to 85°C • Humidity - 10 to 90% RH (non-condensing) • Operating Vibration - IEC68-2-64 • Operating Shock - Operating: 3G peak acceleration (11 msec. duration) - Non-operating: 5G peak acceleration (11 msec. duration)
Construction	• Front Bezel aluminum + Chassis Sheet Metal
Dimensions	• 300mm x 75mm x 217mm (W x H x D)
Mounting	Wall mount
Weight	• 3.7 kg
OS Support	Windows 10 Linux
STANDARDS AND CERTIFICATIONS	<ul style="list-style-type: none"> • Shock Operating: 3G Non-operating: 5G • Vibration Operating: Random 5~500Hz 1G Non-operating: Sweep Sine 10~500Hz 2G • Package Drop ISTA Project 2A • CE/FCC Class A (to be applied)
Other Features	• Watchdog Timer function; System Reset, programmable via software from 1 to 255 Seconds

Getting to Know the DT122-GH

Front View

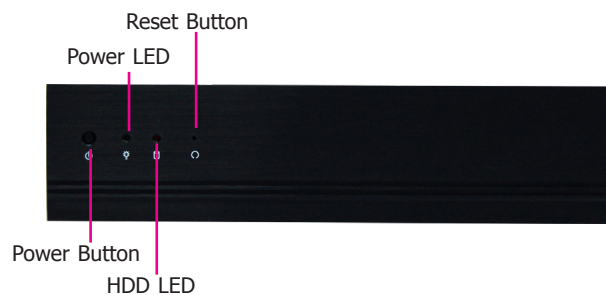

Power Button

Press to power on or power off the system.

Reset Button

Press to reset the system.

HDD LED (red)

Indicates the status of the hard drive. It blinks when the storage devices of the system are being accessed.

Power LED (green)

Indicates the power status of the system. It is green when the system is powered on.

Rear View

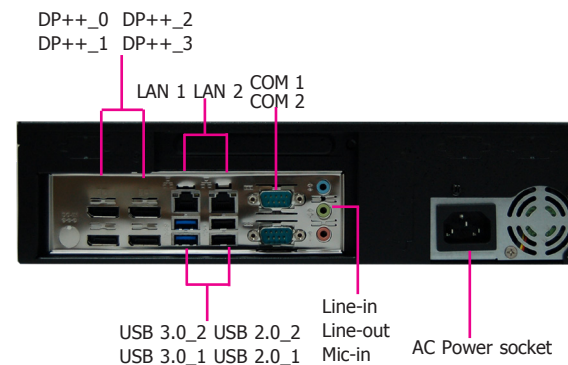

DP++ Ports

Connects to the DisplayPort of an LCD monitor.

COM 1/COM 2 Port

Connects serial devices.

USB Ports

Connect USB 3.0/2.0/1.1 devices.

LAN Ports

Used to connect the system to a local area network.

Line-in

Connects an external audio device such as musical instruments and amplifiers.

Line-out

Connects a speaker.

Mic-in

Connects an external microphone.

Mechanical Dimensions

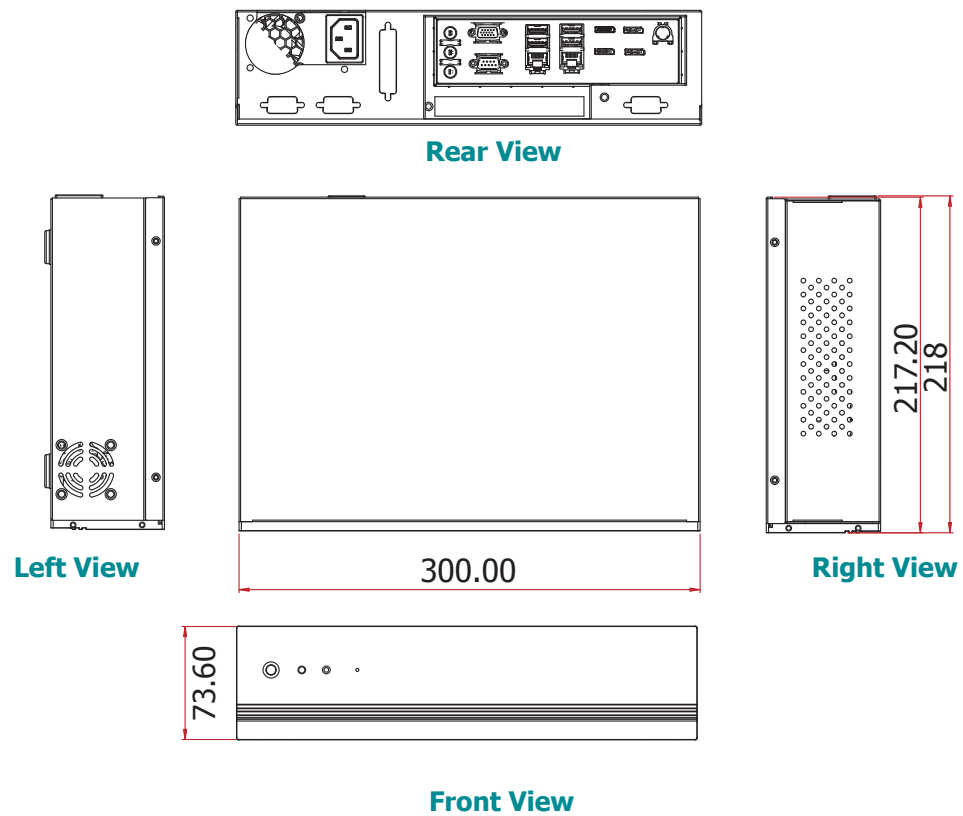

Chapter 2 - Getting Started

Preparing the System

Before you start using the system, you need the following items:

- SATA drive
- M.2 module
- AC power cord
- PS/2 or USB keyboard/mouse
- Screwdriver
- Memory module (optional)

Installing Devices

The following are devices that can be installed in the system.

- Memory modules
- M.2 modules

Configuring the BIOS

To get you started, you may need to change configurations such as the date, time and the type of hard disk drive.

1. Power on the system.
2. After the memory test, the message "Press DEL to run setup" will appear on the screen. Press the Delete key to enter the AMI BIOS setup utility.

Installing the Operating System

Most operating system software can be installed using a DVD (and DVD burner) or bootable USB drive.

Make sure a SATA or an M.2 module is already installed.

1. Refer to the following chapters for information about installing a storage device.
2. Refer to your operating system manual for instructions on installing the operating system.

Installing the Drivers

The system requires you to install drivers for some devices to operate properly. Refer to the Supported Software chapter for instructions on installing the drivers.

Chapter 3 - Installing Devices



Import:

To prevent damage to the system board, power down the system and remove all AC power cords before opening the chassis cover.

Opening the chassis

1. Make sure the system and all other peripheral devices connected to it have been powered off.
2. Disconnect all power cords and cables.
3. The 4 mounting screws on the sides of the system are used to secure the cover to the chassis. Remove these screws and then put them in a safe place for later use.

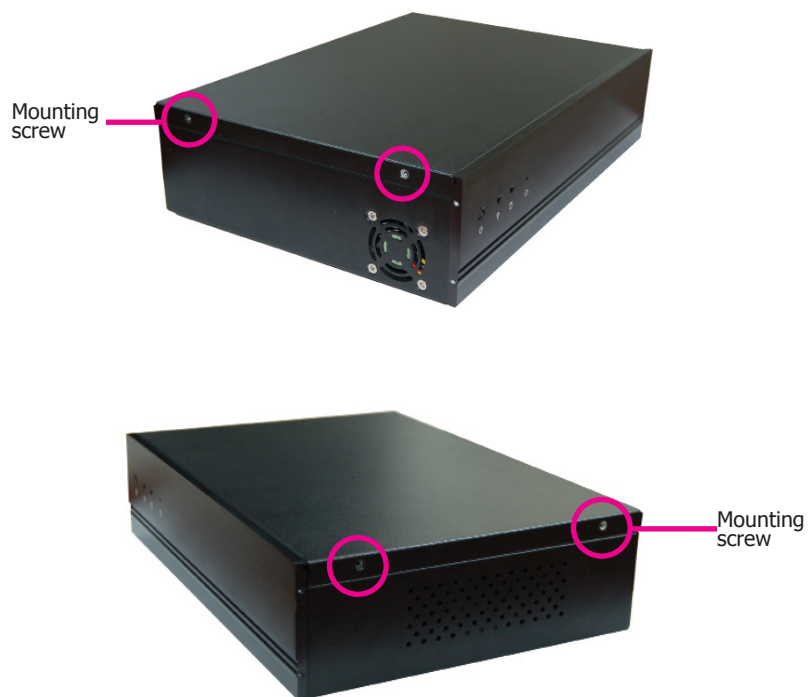

4. Slide the cover backwards to open the system.



5. The DIMM sockets and SATA drive bay are readily accessible after removing the chassis cover.

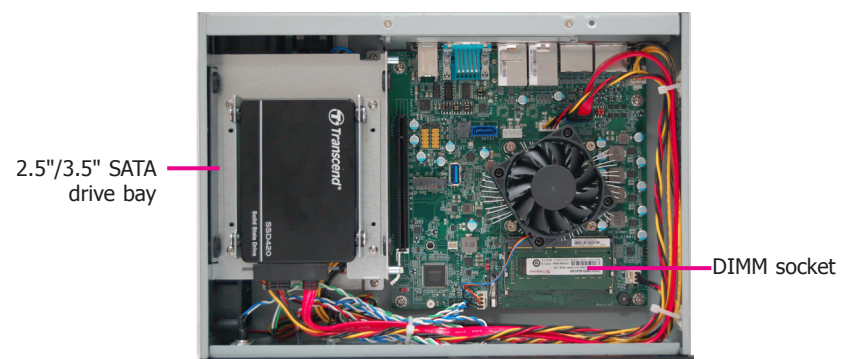

Installing a 2.5" or 3.5" SATA Drive

Installing a 2.5" SATA Drive

The system can accommodate one 3.5" HDD or two 2.5" HDDs.

1. To install a 2.5" HDD, use the 2.5" HDD bracket as shown below. Align the mounting holes on the SATA drive with the mounting holes on the HDD bracket and use the mounting screws provided in the drive bay kit to secure the drive in place.

Mounting screws (step screws)

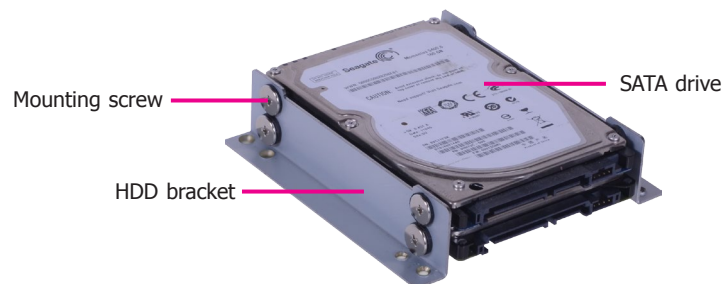

2. Place the HDD bracket with the installed SATA drives back into the chassis and use the provided mounting screws to attach the HDD bracket to the drive bay. Use the provided mounting screws to attach the HDD bracket to the drive bay.

Mounting screws

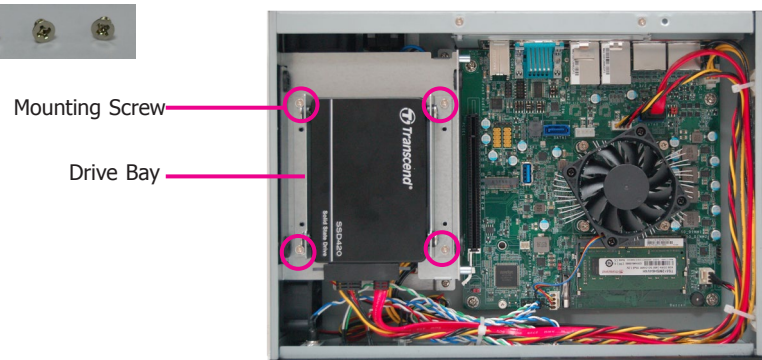

3. Connect the SATA data and power cable to the SATA drive.

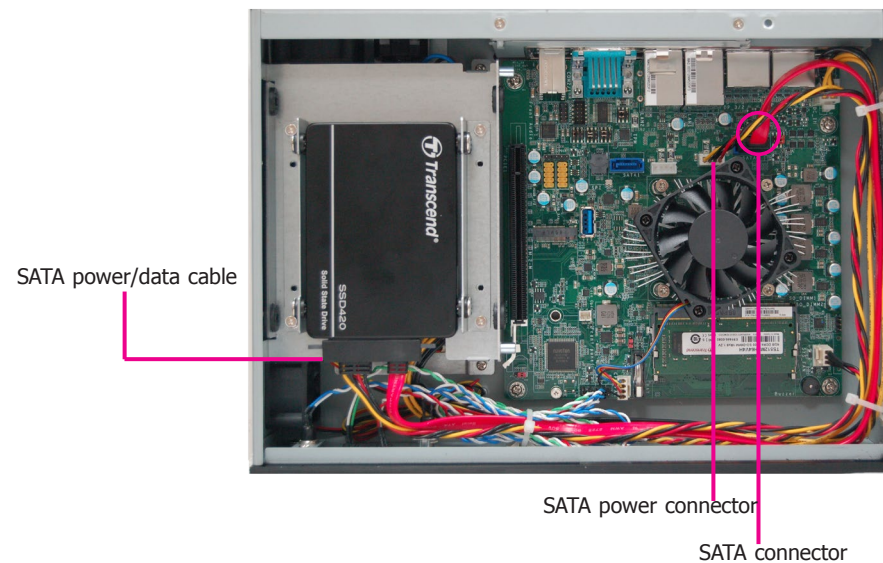

Installing a 3.5" SATA Drive

To install a 3.5" HDD, please directly mount the HDD on the drive bay as shown below. First, remove the 6 mounting screws (or 4 screws if a PCIe riser card is not used) that secure the drive bay to the system.

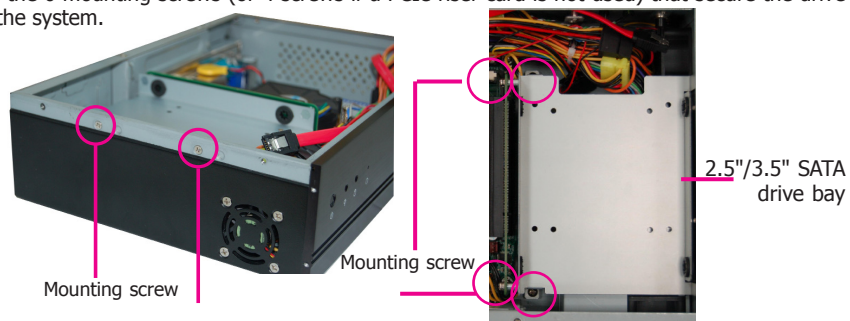

1. Insert spacers included in the HDD drive bay kit into the anti-shock bumpers of the HDD bracket. You will find the spacers in the HDD drive bay kit.



2. Align the mounting holes on the SATA drive with the mounting holes on the drive bay, and then use the provided mounting screws to install the SATA drive on the drive bay.

Mounting Screws



3. Place the drive bay back into the chassis and install the drive bay with 4 mounting screws.



Installing an M.2 Module

The system board is equipped with 1 M.2 slot (Type 2280, M key) that can accommodate a PCIe NVMe module up to PCIe Gen 3.0 x4 bandwidth. Note it does not support SATA SSD modules.

1. Grasp the Mini PCIe card by its edges and align the notch in the connector of the PCIe card with the notch in the connector on the system board.
2. Push the Mini PCIe card down and use the provided mounting screw to secure the card on the system board.

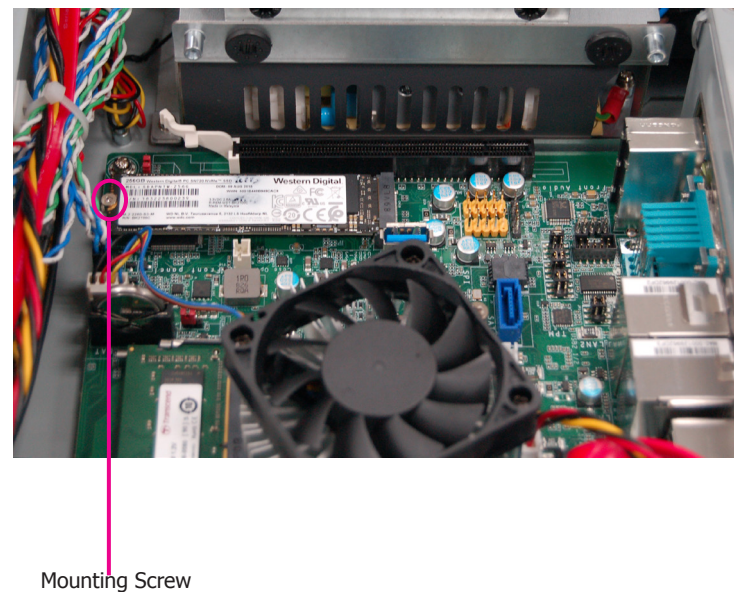

Installing a PCIe Expansion Card



Important:

When inserting the riser card, please select a card within 175mm in order to fit into the chassis.



1. The PCIe x16 on the motherboard is used to insert a PCIe expansion card.

To install an expansion card, you need to remove the mounting screw that secure the bracket to the chassis. Put the screw and the bracket in a safe place for later use.

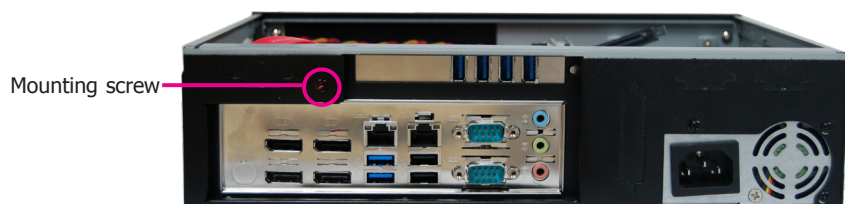

2. Take off the shielding plate.

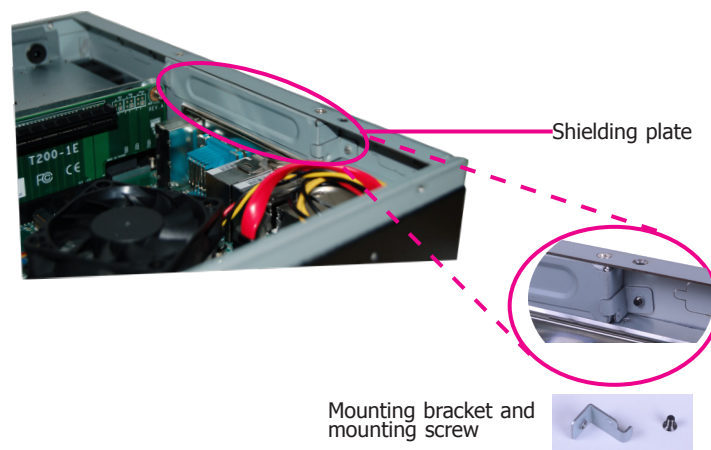

3. Insert the expansion card and secure it in place using the mounting bracket and screw that you removed in step 1.

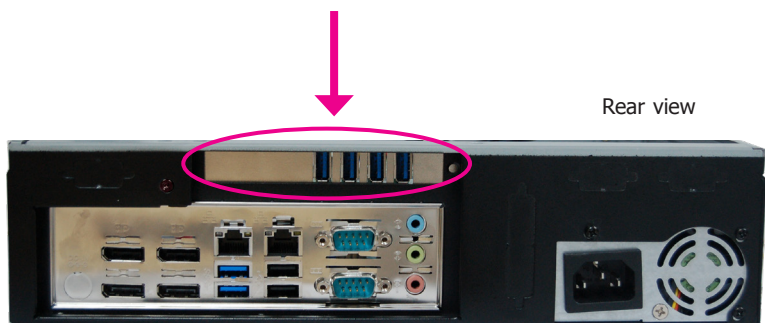
**Note:**

1. The expansion card used in the above illustrations may not resemble the actual cards. These illustrations are for reference only.
2. The T200-1E riser card provides one PCIe x16 expansion slot; the T200-1P riser card provides one PCI expansion slot.

Chapter 4 - Jumper Settings

Clear CMOS Data

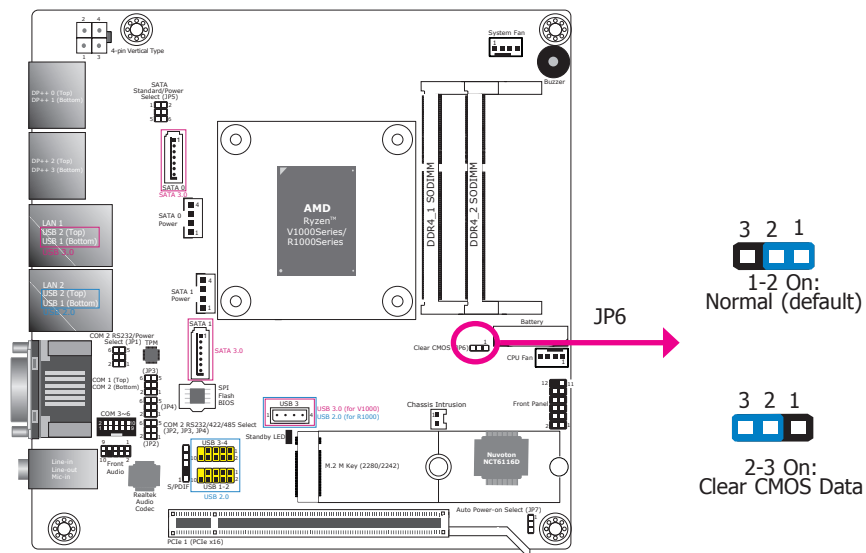

If you encounter the following situations, you can reconfigure the system with the default values stored in the ROM BIOS.

- CMOS data becomes corrupted.
- You forgot the supervisor or user password.

To load the default values stored in the ROM BIOS, please follow the steps below.

- Power off the system and unplug the power cord.
- Set the jumper pins 2 and 3 to On. Wait for a few seconds and set the jumper pins back to its default setting, pins 1 and 2 On.
- Now plug the power cord and power on the system.

Auto Power-on Select

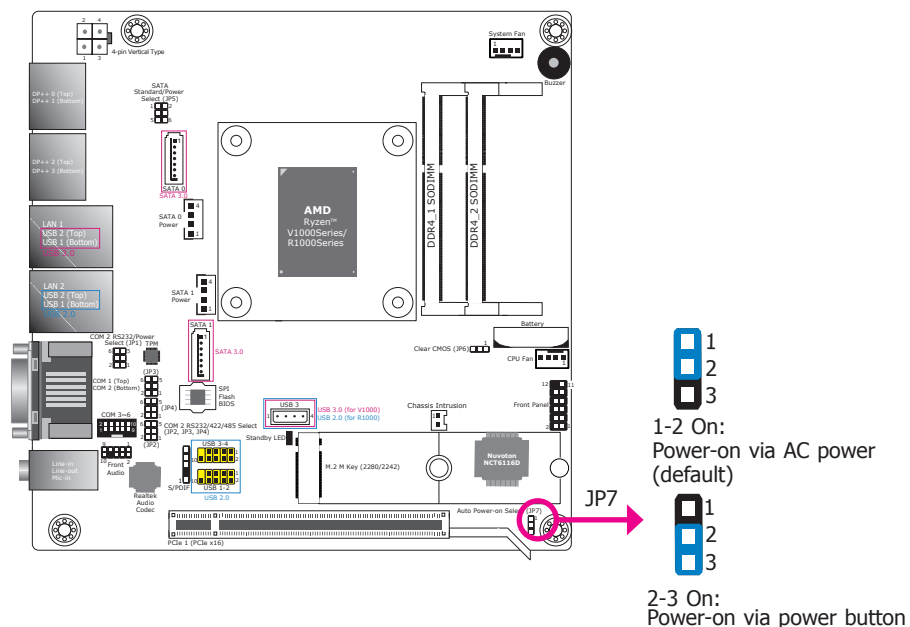

JP7 is used to select the method of powering on the system. If you want the system to power-on whenever AC power comes in, set jumper pins 1 and 2 to On. If you want to use the power button, set pins 2 and 3 to On.

COM2 RS232/Power Select

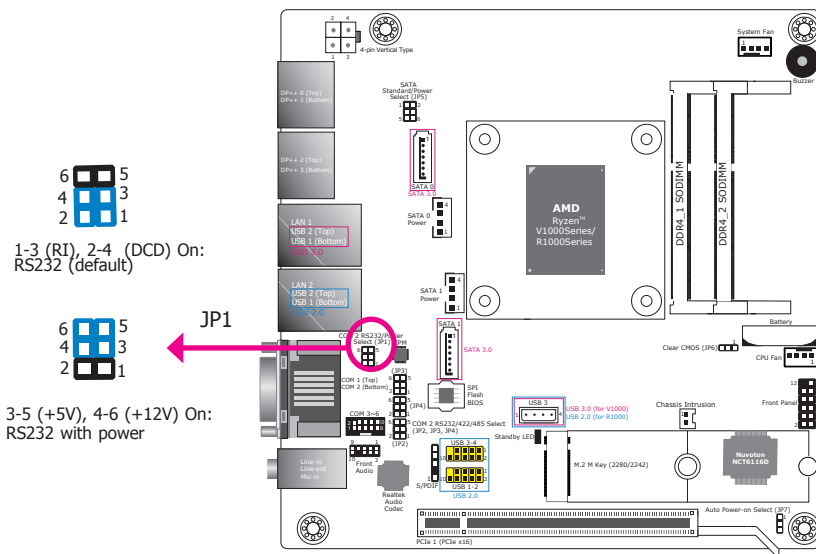

JP1 is used to configure the Serial COM port 2 to pure RS232 or RS232 with power. The pin functions of COM 2 will vary according to JP1's settings.

COM2 RS232/422/485 Select

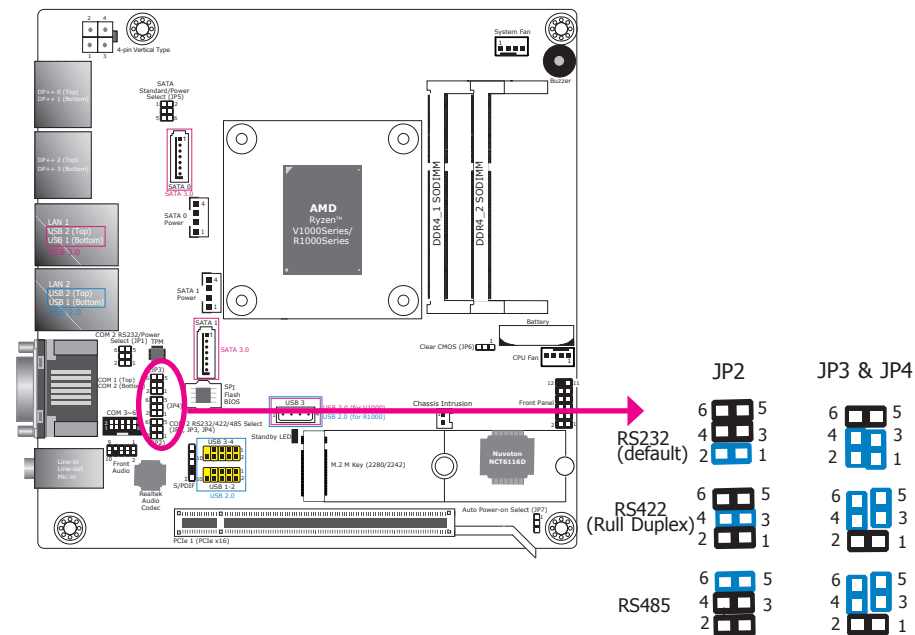

JP2, JP3 and JP4 are used to select the communication mode of COM Port 2 among RS232 (default), 422 and 485. And when it is set to RS232, you can configure it to be a standard RS232 or RS232 with power.

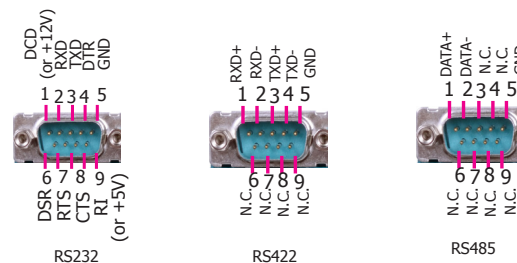

SATA Ports Signal Select

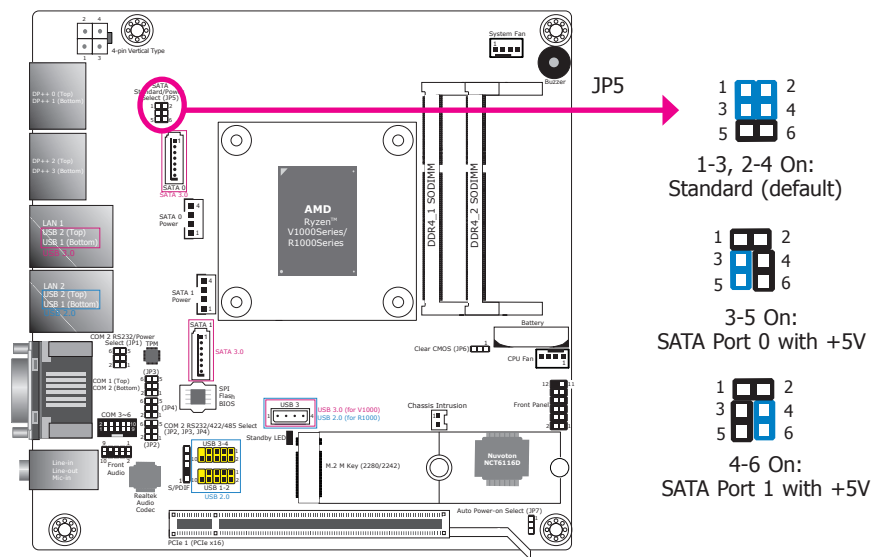

JP5 is used to select the SATA connector to have +5V power on pin 7.

Chapter 5 - Ports and Connectors

Audio Ports

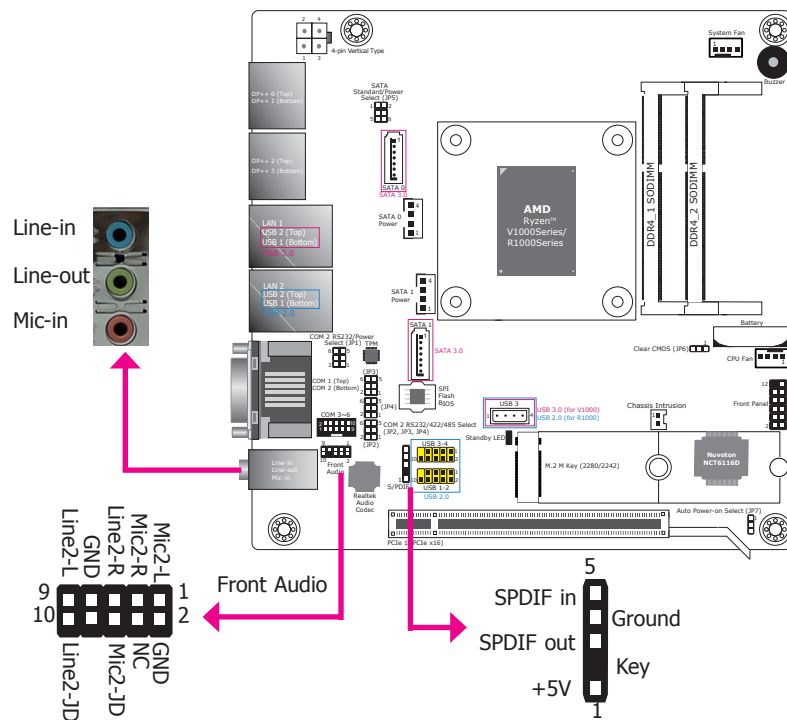

- **Audio Jacks**

The audio connectors include line-in (blue), line-out (green) and microphone jacks (pink) as well as the digital audio with the S/PDIF connector. The front audio connector allows you to connect additional line-out and microphone outputs. These audio ports are provided by Realtek ALC887-VD Audio Codec.

- **Front Audio**

The front audio connector allows you to connect to the second line-out and mic-in jacks that are at the front panel of your system.

- **BIOS Setting**

Configure the audio controller in the "Advanced" menu ("AMD CHIPSET Setting" > "GFX Configuration" > "NB Azalia") of the BIOS. Refer to Chapter 7 for more information.

- **Driver Installation**

You may need to install audio driver in your operating system to use audio devices. Refer to Chapter 8 and your operating system's documentation for more information.

Display Outputs

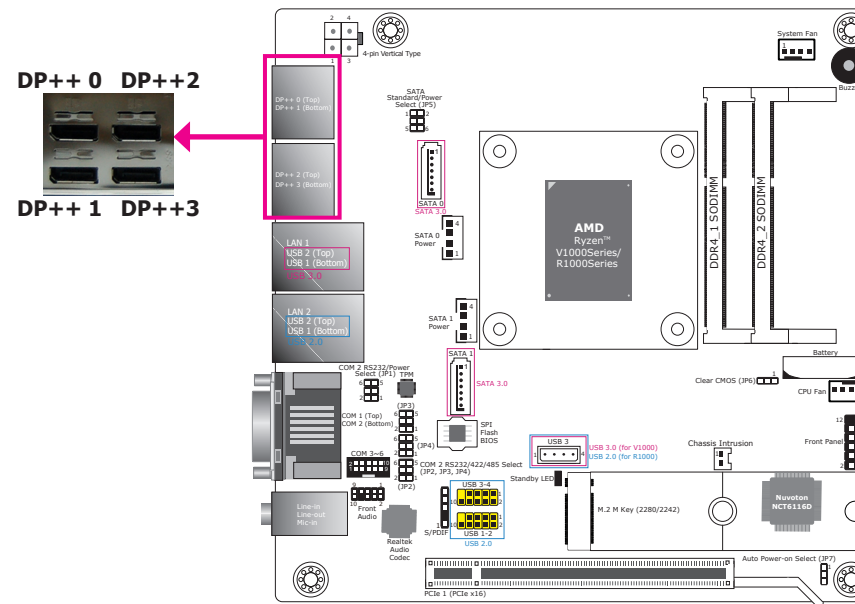

The DisplayPort, a digital display interface, is provided by the integrated AMD® Radeon™ Vega graphics and can be connected to LCD monitors. These ports support resolution up to 4096x2160. Note that the AMD® Ryzen™ V1000 series processors support 4 DP++ ports powered by its Vega GPU (with up to 11CUs). Whereas the R1000 series processors support 3 DP++ ports powered by Radeon™ HD 9000 GPU (with up to 8 CUs).

- **BIOS Setting**

Configure the Integrated Graphics Controller in the "Advanced" menu ("AMD CHIPSET Setting" > "GFX Configuration") of the BIOS. Refer to Chapter 7 for more information.

- **Driver Installation**

Install the AMD® Radeon™ graphics driver and software. Please refer to Chapter 8 for more information.

USB Ports

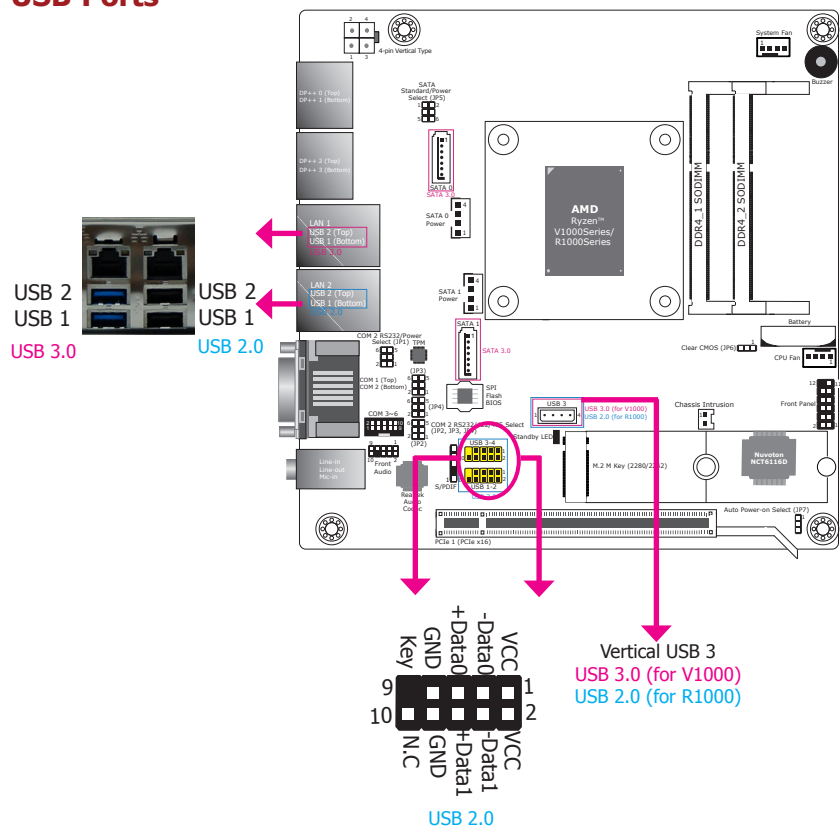

DC-in

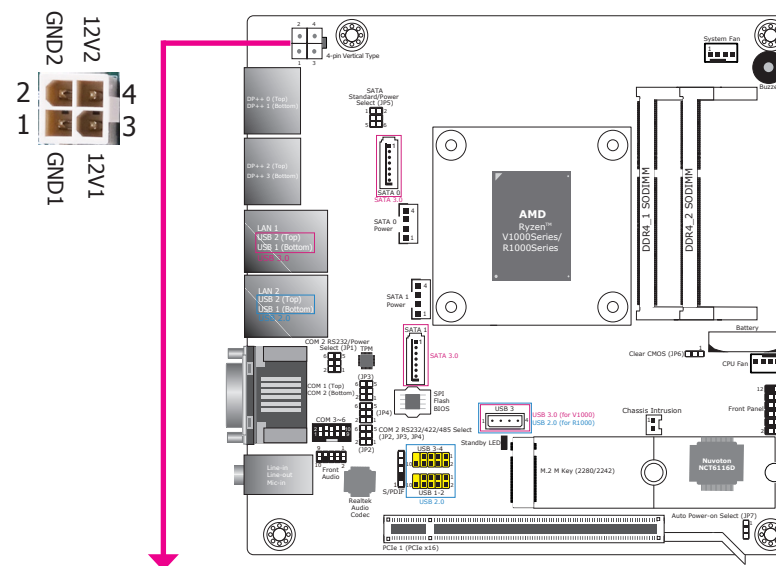

The USB devices allow data exchange between your system and a wide range of simultaneously accessible external Plug and Play peripherals.

The system board is equipped with two onboard USB 3.0 ports (USB 3.0_1-2) and USB 2.0 ports (USB2.0_1-2) on the rear panel I/O ports. The 10-pin connectors allow you to connect 4 additional USB 2.0 ports (HUSB 1-2/3-4). The vertical USB 3 (USB 3.0_3 for V1000 series processors or USB 2.0_3 for R1000 series processors) can be used to connect a security device such as a protection dongle internally.

• BIOS Setting

Configure the USB ports including its communication mode in the "Advanced" menu ("USB Configuration" and "SB USB Configuration" under the "AMD CHIPSET Setting" menu) of the BIOS. Refer to Chapter 7 for more information.

The 4-pin vertical DC-in connector provides a low power input solution. Please use a power supply unit with 12V DC output voltage. This system is equipped with a 150W switching PSU with input:100~240V and output:12V/8.4A.

Pins	Pin Assignment	Pins	Pin Assignment
1	GND 1	3	12V1
2	GND 2	4	12V2

COM Ports

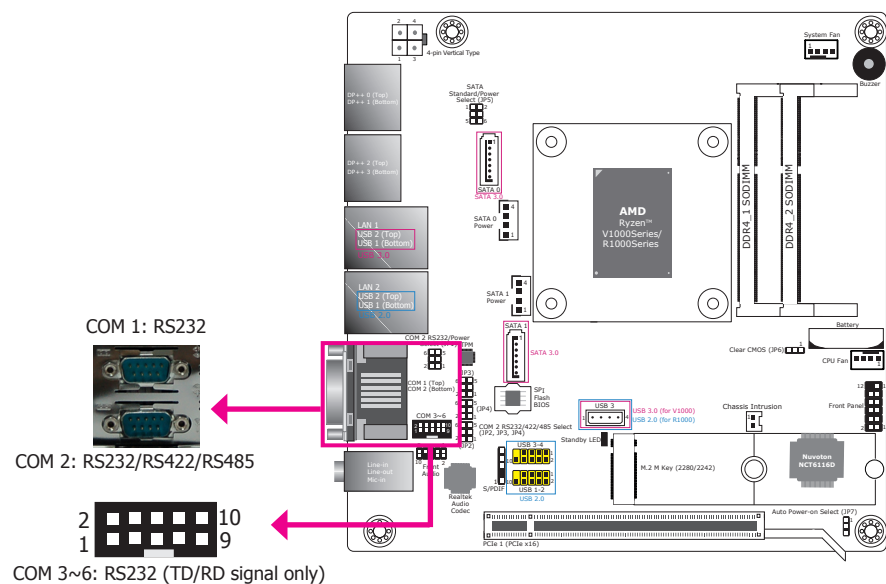

COM 2 can be selected among different communication modes whereas COM 1 can be used in RS232 mode only. COM 3 to COM 6 are pin headers and provide signals (only TX and RX signals) that are different from standard RS232 communication.

Serial Port

The serial port is an asynchronous communication ports that can be used with modems, serial printers, remote display terminals, and other serial devices. In addition, COM 1 and COM 2 can be configured with console redirection through the BIOS, you can monitor and control the system from a remote station.

• BIOS Setting

Configure the COM ports including its communication mode in the "Advanced" menu ("NCT6116D Super IO Configuration" submenu) and ("Serial Port Console Redirection" submenu) of the BIOS. Refer to Chapter 7 for more information.

COM 1 (RS232) / COM 2 (RS232/RS422/RS485)

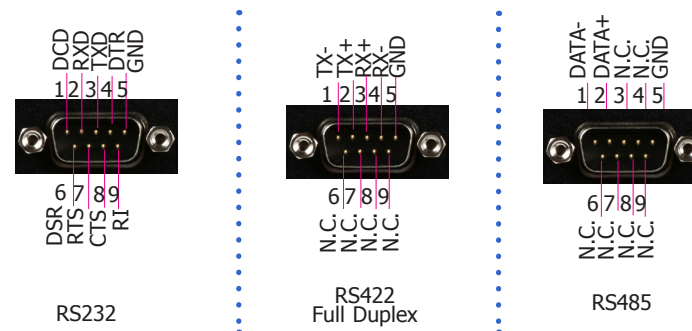

COM 3~COM6: RS232
(TX & RX signals only)

Pins	Pin Assignment	Pins	Pin Assignment
1	COM3 RS232-TX	1	COM4 RS232-TX
3	COM3 RS232-RX	2	COM4 RS232-RX
3	GND	3	GND
4	COM5 RS232-TX	4	COM6 RS232-TX
5	COM5 RS232-RX	5	COM6 RS232-RX

RJ45 LAN Ports

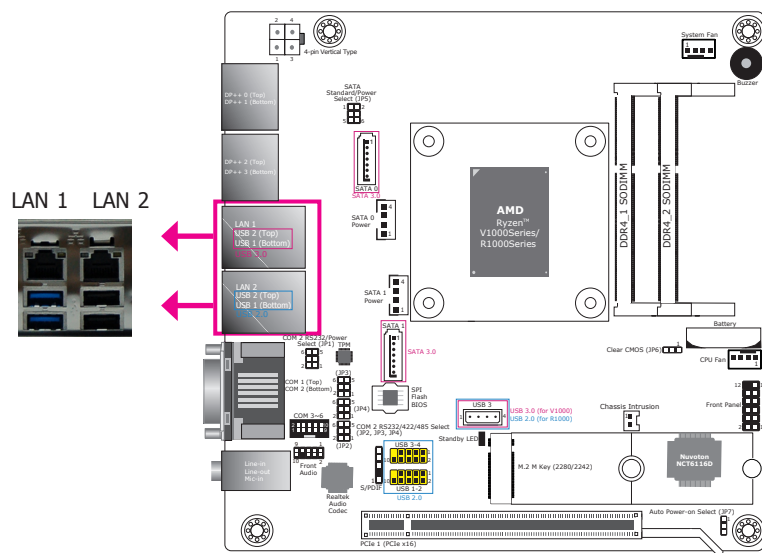

Features

- 2 LAN ports provided by Realtek® RTL8111HN Integrated 10/100/1000 Ethernet Controllers
- The LAN ports provide WOL (Wake On LAN) and PXE (Preboot eXecution Environment) functions and these functions can be configured in the BIOS.

BIOS Setting

Configure the onboard LAN in the "Advanced" menu ("ACPI Configuration" and "Network Stack Configuration" submenus) of the BIOS. Refer to Chapter 7 for more information.

Driver Installation

Install the LAN drivers. Refer to Chapter 8 for more information.

Chassis Intrusion Connector

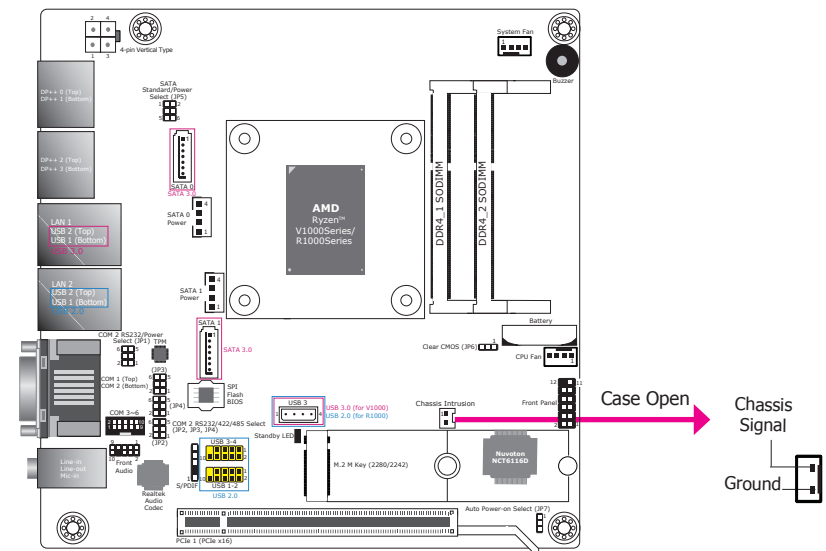

The board supports the chassis intrusion detection function. Connect the chassis intrusion sensor cable from the chassis to this connector. When the system's power is on and a chassis intrusion occurs, an alarm will sound. When the system's power is off and a chassis intrusion occurs, the alarm will sound only when the system restarts.

BIOS Setting

Configure the chassis intrusion detection function in the Advanced menu ("NCT6116D Super IO Configuration" > "Case Open") of the BIOS. Refer to Chapter 7 for more information.

SATA (Serial ATA) Connectors

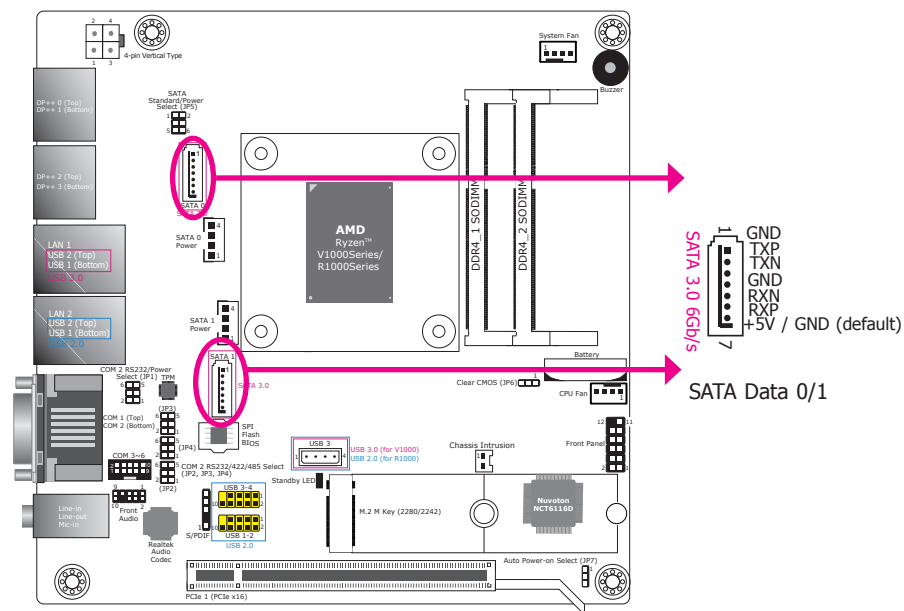

SATA (Serial ATA) Power Connectors

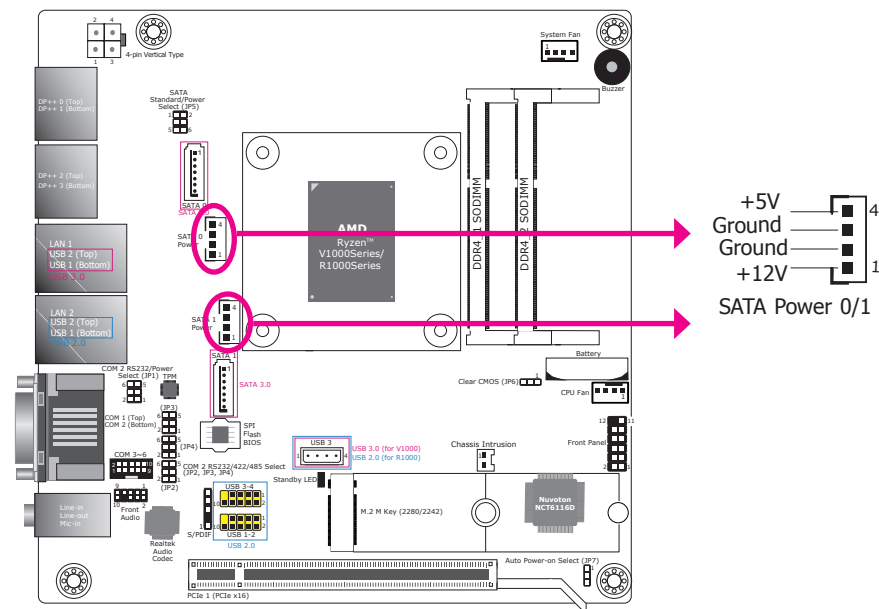

Features

- 2 Serial ATA 3.0 ports
 - SATA port 0 and 1 with data transfer rate up to 6Gb/s
- Pin 7 provides +5V power and switch between +5V and GND via jumper settings

The Serial ATA connectors are used to connect the Serial ATA devices such as a Serial ATA HDD or Disk on Module (SATA DOM). JP5 is used to select between standard SATA or SATA with power. Refer to "SATA Ports Signal Select" in Chapter 4 for more information.

BIOS Setting

Configure the Serial ATA drives in the Advanced menu ("AMD CHIPSET Setting" > "SATA Configuration Options") of the BIOS. Refer to Chapter 7 for more information.

The SATA power connectors supply power to SATA drives. Connect one end of the provided power cable to the SATA power connector and the other end to your storage device.

Expansion Connectors

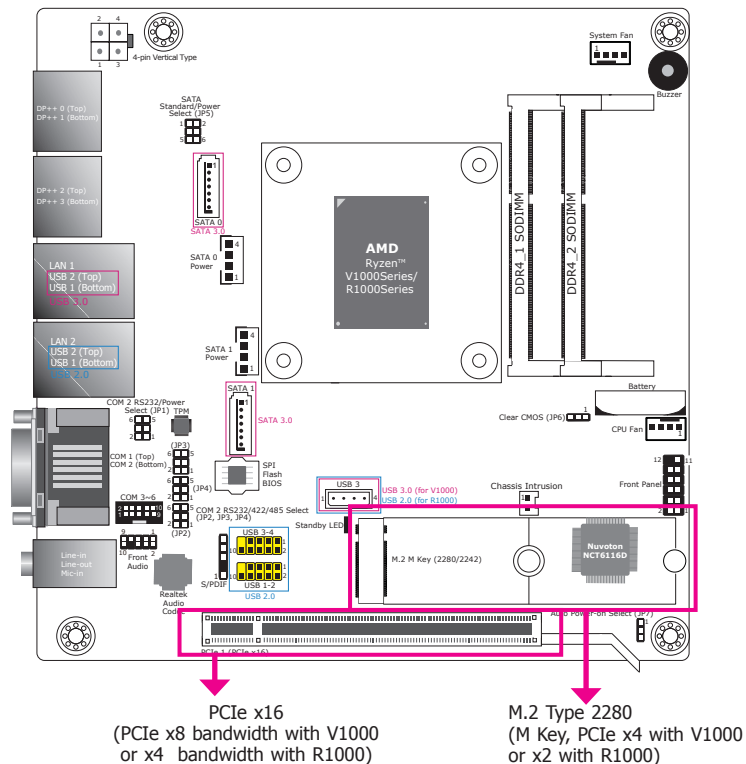

M.2 M Key slot

The M.2 type 2280 card slot (M Key) supports PCIe NVMe 3.0 x4 interface (or x2 with R1000 processors) to accommodate NVMe SSDs. It can be inserted with an M.2 (NGFF) card with the form factor of 22x80 mm. Note this slot does not provide SATA interface.

PCI Express x16 Slot

Install PCI Express x16 graphics card, that comply to the PCI Express specifications, into the PCI Express x16 slot such as a graphics card.

BIOS Setting

Configure external graphics card including the AMD Hybrid Graphics technology in the Advanced menu ("Advanced" > "AMD Platform Setting") of the BIOS. Refer to Chapter 7 for more information.

CPU/System Fan Connector

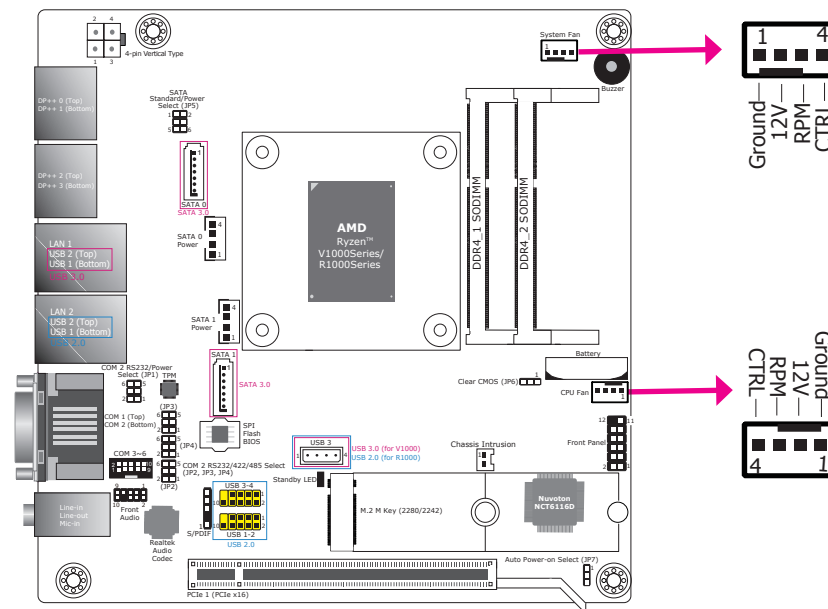

The fan connectors are used to connect cooling fans. The cooling fan will provide adequate airflow throughout the chassis to prevent overheating the CPU and system board components.

BIOS Setting

The Advanced menu ("NCT6116D HW Monitor" submenu) of the BIOS will display the current speed of the cooling fans. Refer to the Chapter 7 for more information.

Front Panel & LEDs

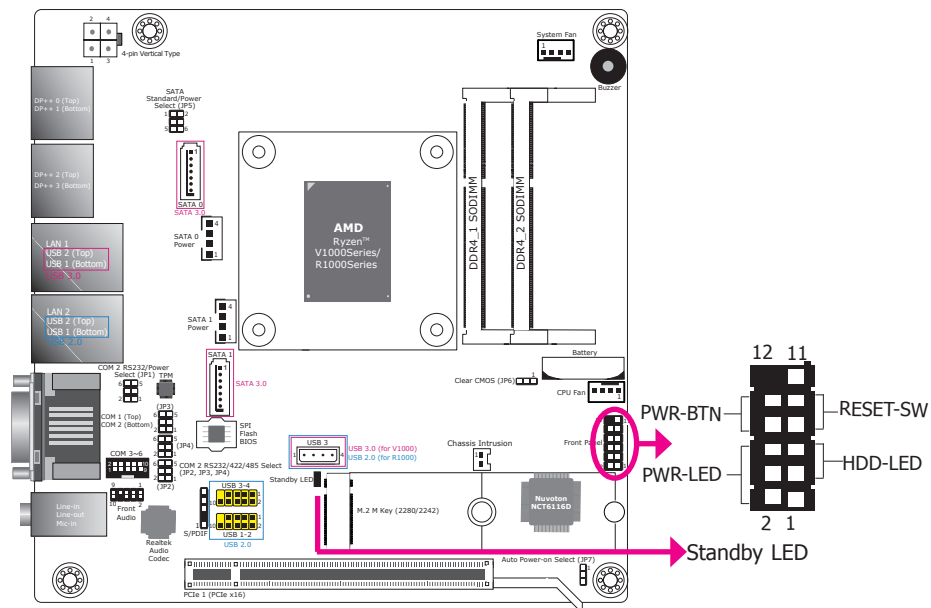

Standby LED

This LED will be red when the system is in the standby mode. It indicates that there is power on the system board. Power-off the PC and then unplug the power cord prior to installing any devices. Failure to do so will cause severe damage to the motherboard and components.

HDD-LED - HDD LED

This LED will light up when the hard drive is being accessed.

RESET SW - Reset Switch

This switch allows you to reboot without having to power off the system.

PWR-BTN - Power Switch

This switch is used to power on or off the system.

PWR-LED - Power/Standby LED

When the system's power is on, this LED will light up. When the system is in the S1 (POS - Power On Suspend) state, it will blink every second. When the system is in the S3 (STR - Suspend To RAM) state, it will blink every 4 seconds.

	Pin	Pin Assignment		Pin	Pin Assignment
HDD-LED	3	HDD Power	PWR-LED	2	LED Power
	5	Signal		4	LED Power
RESET SW	7	Ground	PWR-BTN	6	Signal
	9	RST Signal		8	Ground
	11	N.C.		10	Signal

Battery

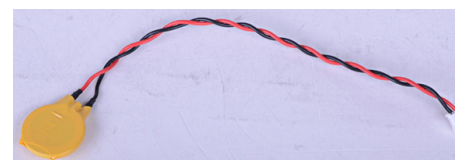
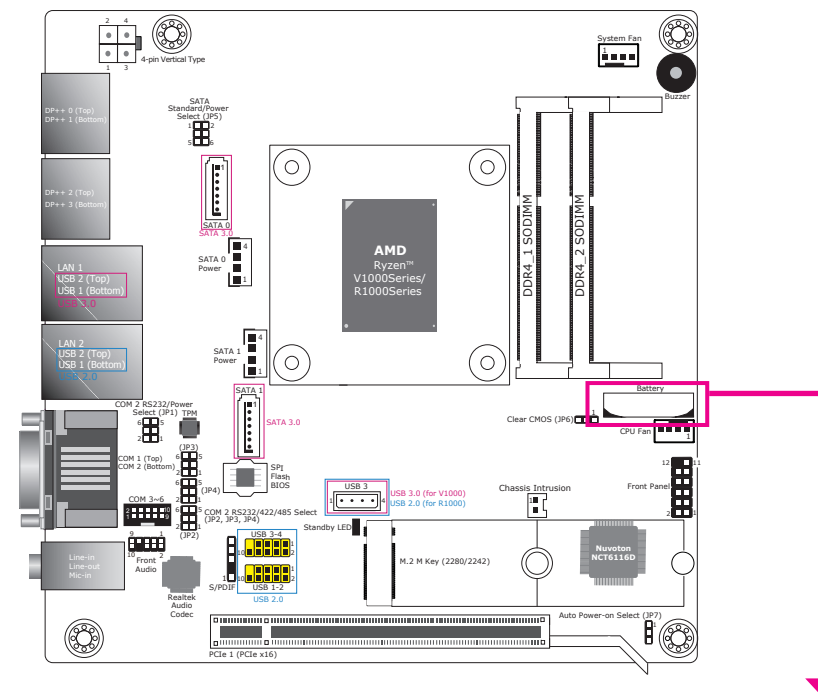

Battery

Connect to the battery connector

The lithium ion battery powers the real-time clock and CMOS memory. It is an auxiliary source of power when the main power is shut off.

Safety Measures

- Danger of explosion if battery is incorrectly replaced.
- Replace only with the same or equivalent type recommend by the manufacturer.
- Dispose of used batteries according to local ordinance.

Chapter 6 - Mounting Options

Wall Mount



Note:
The system unit used in the following illustrations may not resemble the actual one. These illustrations are for reference only.

There are 2 types of wall mount brackets:

- Type A



- Type B



Type A wall mount kit includes:

- 2 type A wall mount brackets



- If the mounting screws have been previously attached to the top cover of the system, please remove them first.

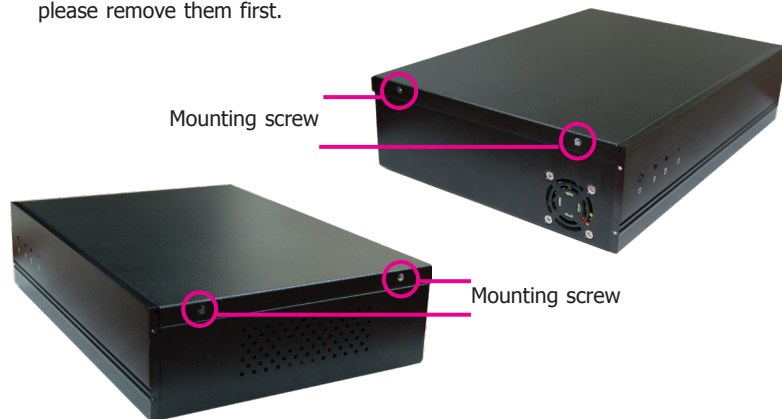

- Use the mounting screws removed in step 1 to secure the wall mount brackets on each side of the system.

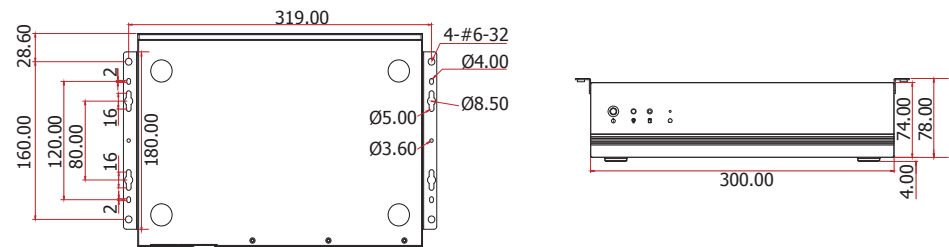
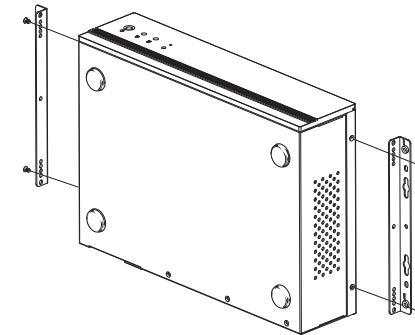
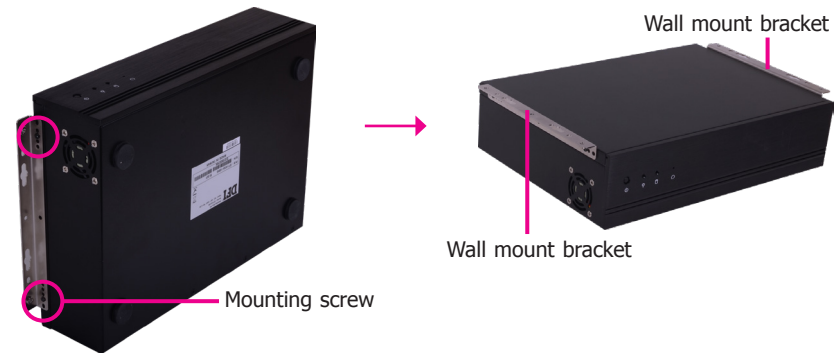

-  Type B wall mount kit includes:
- 2 type B wall mount brackets
 - Bracket screws



1. The 4 mounting holes on the sides of the system are used to mount the wall mount brackets.

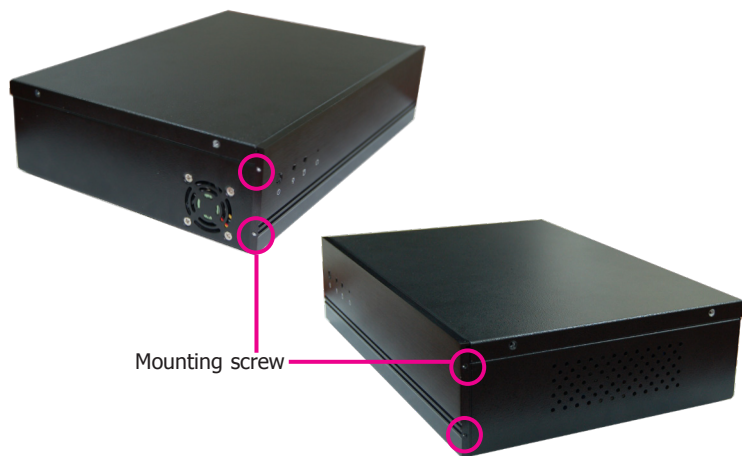

2. Use the provided mounting screws to secure the wall mount brackets on each side of the system.

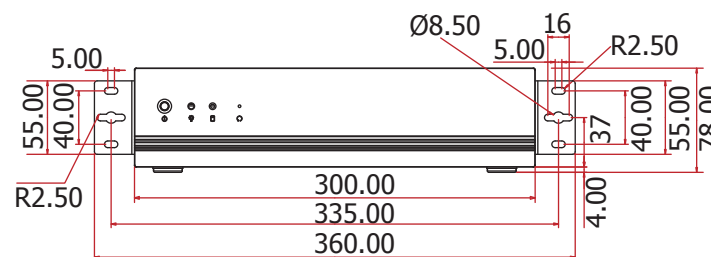
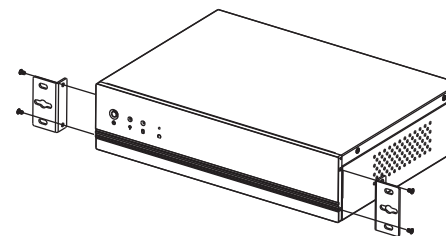

Chapter 7 - BIOS Setup

Overview

The BIOS is a program that takes care of the basic level of communication between the CPU and peripherals. It contains codes for various advanced features found in this system board. The BIOS allows you to configure the system and save the configuration in a battery-backed CMOS so that the data retains even when the power is off. In general, the information stored in the CMOS RAM of the EEPROM will stay unchanged unless a configuration change has been made such as a hard drive replaced or a device added.

It is possible that the CMOS battery will fail causing CMOS data loss. If this happens, you need to install a new CMOS battery and reconfigure the BIOS settings.



Note:

The BIOS is constantly updated to improve the performance of the system board; therefore the BIOS screens in this chapter may not appear the same as the actual one. These screens are for reference purpose only.

Default Configuration

Most of the configuration settings are either predefined according to the Load Optimal Defaults settings which are stored in the BIOS or are automatically detected and configured without requiring any actions. There are a few settings that you may need to change depending on your system configuration.

Entering the BIOS Setup Utility

The BIOS Setup Utility can only be operated from the keyboard and all commands are keyboard commands. The commands are available at the right side of each setup screen.

The BIOS Setup Utility does not require an operating system to run. After you power up the system, the BIOS message appears on the screen and the memory count begins. After the memory test, the message "Press DEL to run setup" will appear on the screen. If the message disappears before you respond, restart the system or press the "Reset" button. You may also restart the system by pressing the <Ctrl> <Alt> and keys simultaneously.

Legends

Keys	Function
Right and Left arrows	Moves the highlight left or right to select a menu.
Up and Down arrows	Moves the highlight up or down between submenu or fields.
<Esc>	Exit the BIOS Setup Utility.
+ (plus key)	Scrolls forward through the values or options of the highlighted field.
- (minus key)	Scrolls backward through the values or options of the highlighted field.
<F1>	Displays general help
<F2>	Pervious values
<F9>	Optimized defaults
<F10>	Saves and resets the setup program.
<Enter>	Press <Enter> to enter the highlighted submenu.

Scroll Bar

When a scroll bar appears to the right of the setup screen, it indicates that there are more available fields not shown on the screen. Use the up and down arrow keys to scroll through all the available fields.

Submenu

When "►" appears on the left of a particular field, it indicates that a submenu which contains additional options are available for that field. To display the submenu, move the highlight to that field and press <Enter>.

AMI BIOS Setup Utility

Main

The Main menu is the first screen that you will see when you enter the BIOS Setup Utility.

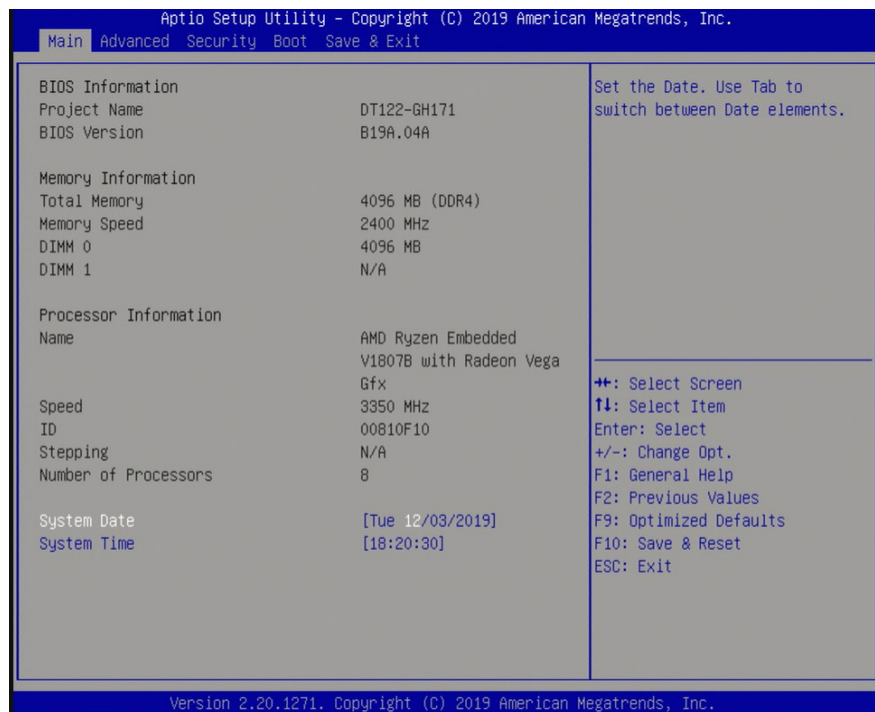

System Date

The date format is <day>, <month>, <date>, <year>. Day displays a day, from Sunday to Saturday. Month displays the month, from January to December. Date displays the date, from 1 to 31. Year displays the year, from 1980 to 2099.

System Time

The time format is <hour>, <minute>, <second>. The time is based on the 24-hour military-time clock. For example, 1 p.m. is 13:00:00. Hour displays hours from 00 to 23. Minute displays minutes from 00 to 59. Second displays seconds from 00 to 59.

Advanced

The Advanced menu allows you to configure your system for basic operation. Some entries are defaults required by the system board, while others, if enabled, will improve the performance of your system or let you set some features according to your preference.



Important:

Setting incorrect field values may cause the system to malfunction.

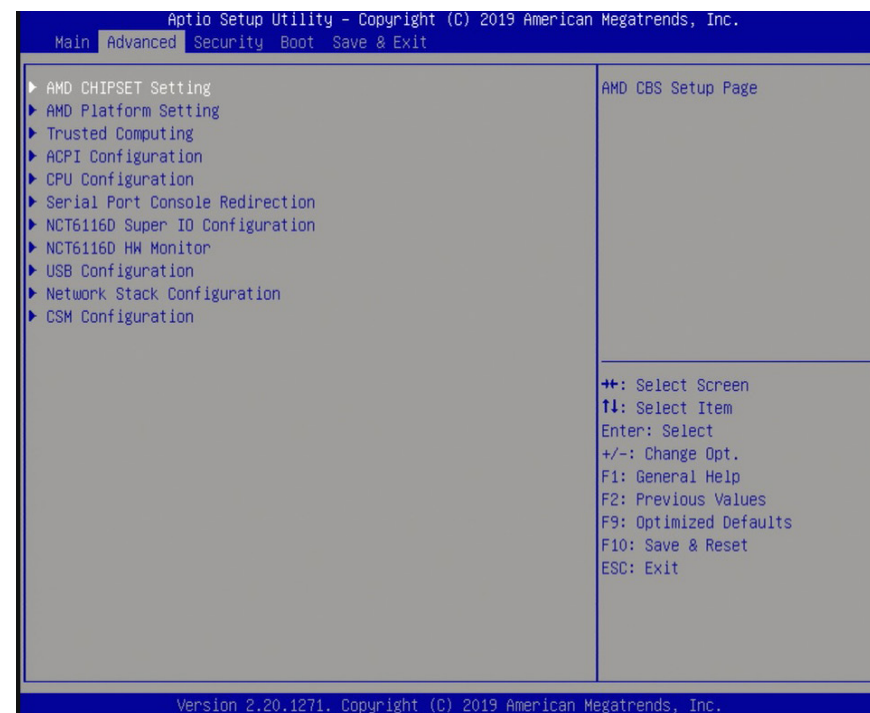

AMD CHIPSET Setting

This section configures the parameters of the AMD chipset.

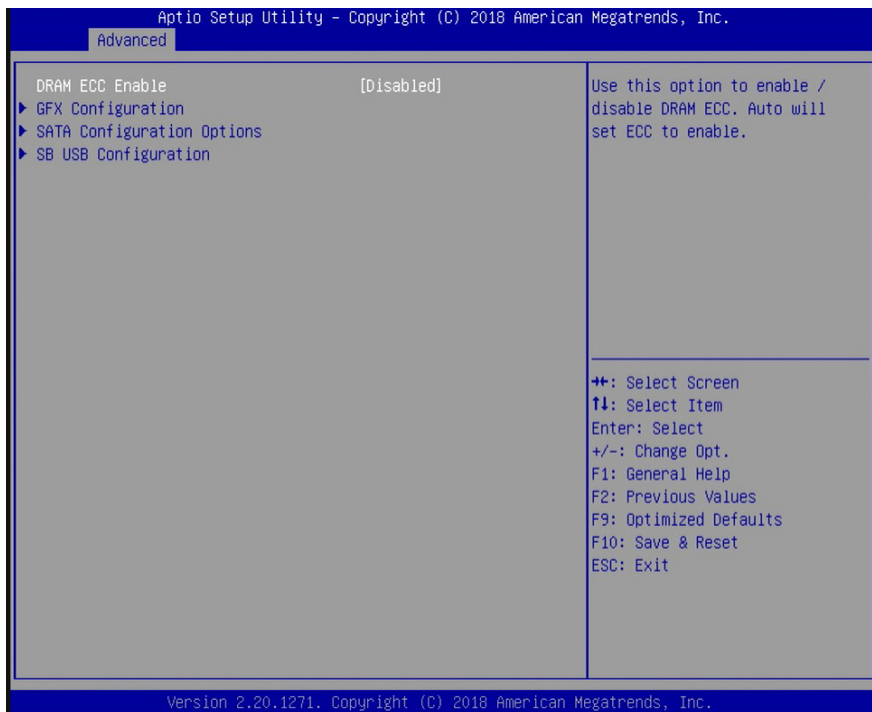

DRAM ECC Enable

Enable or disable the support for ECC memory.

GFX Configuration

This section configures the parameters of the integrated graphics.

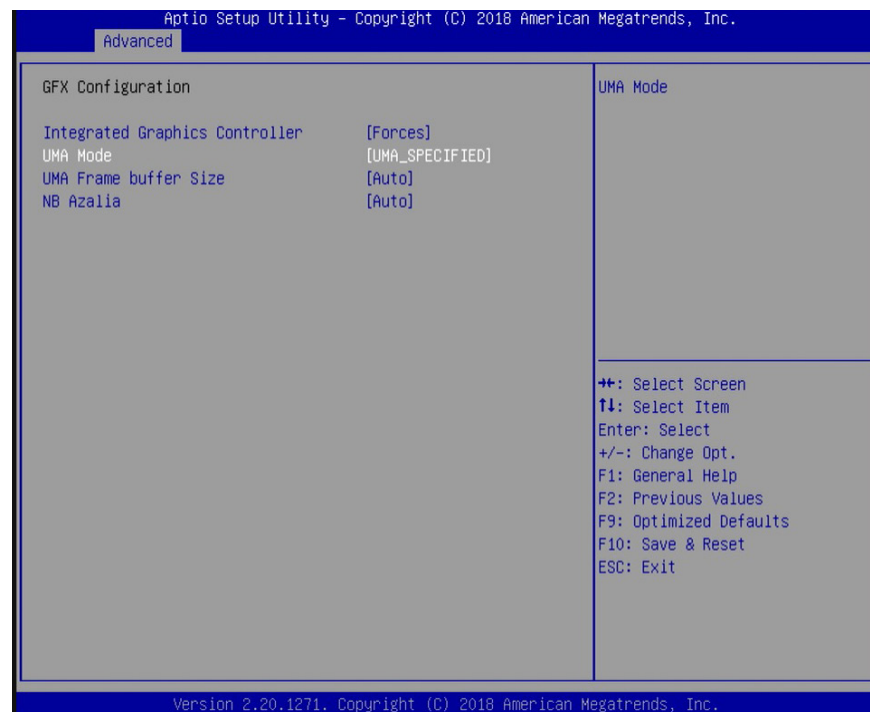

Integrated Graphics Controller

Configure the integrated graphics controller with these options: Disabled, Forces, or Auto.

UMA Mode

This option only appears if the Integrated Graphics Controller is set to Forces. Select the UMA (Unified Memory Architecture) mode from these options: Auto or UMA_SPECIFIED.

UMA Frame buffer Size

This option only appears if you choose to specify the UMA mode. Configure the UMA frame buffer size with these options: Auto, 64M, 128M, 256M, 384M, 512M, 1G, or 2G.

NB Azalia

Automatically configure the integrated high-definition audio controller or disable it.

SATA Configuration Options

This section configures the parameters of the SATA controller.

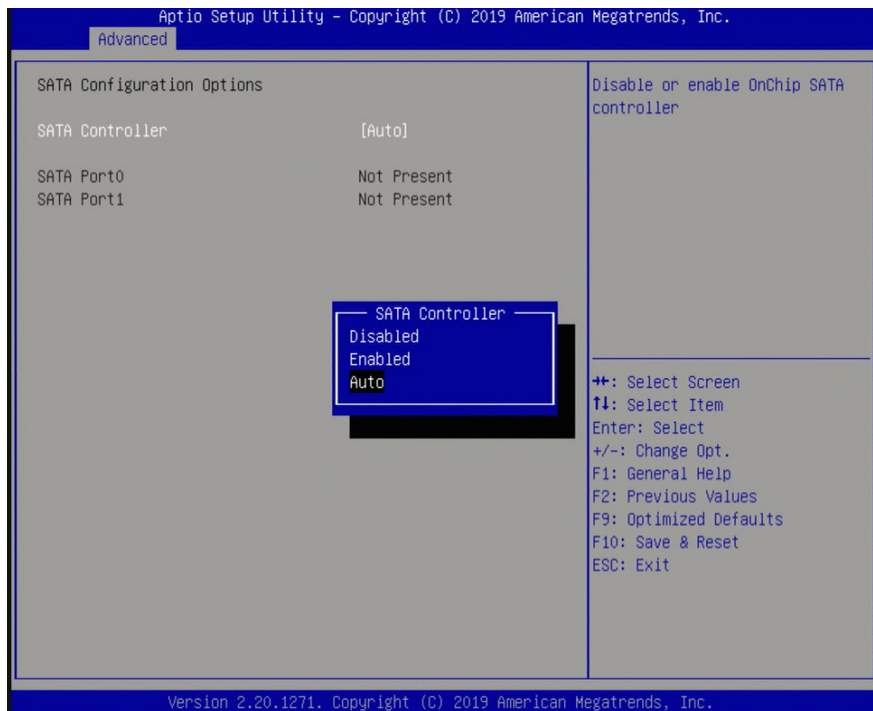

SATA Controller

Enable, disable or automatically configure the SATA controller.

SATA Port 0 & 1

Enable or disable each SATA port.

SB USB Configuration

This section configures the parameters of the USB controller.

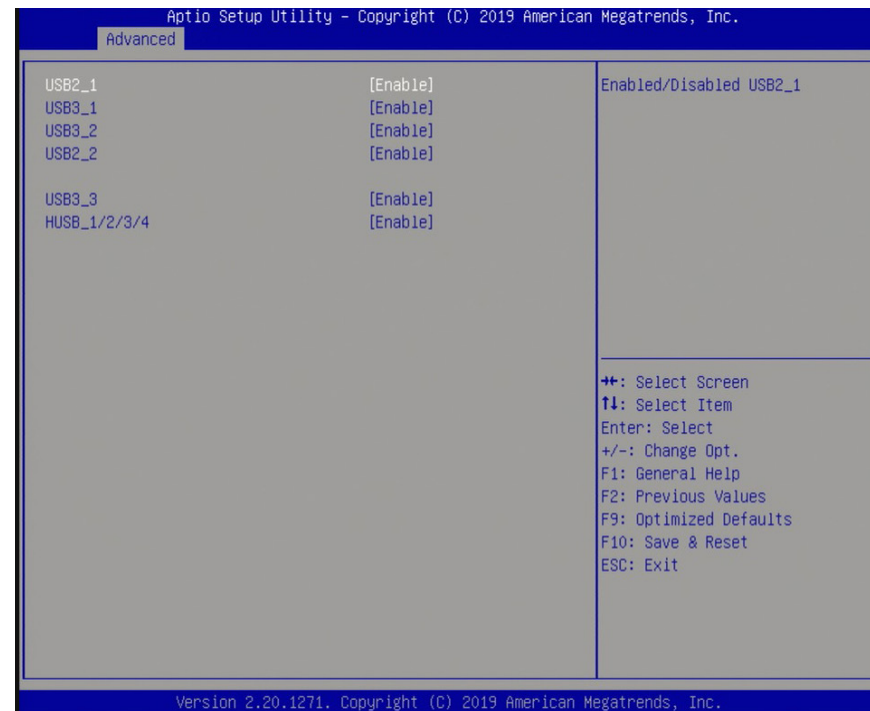

USB2_1 USB2_2, HUSB_1/2/3/4

Enable or disable each USB 2.0 port.

USB3_1, USB3_2, USB 3_3 (or USB 2_3 for R1000 series processors)

Enable or disable each USB 3.0 port.

AMD Platform Setting

This section configures display settings.

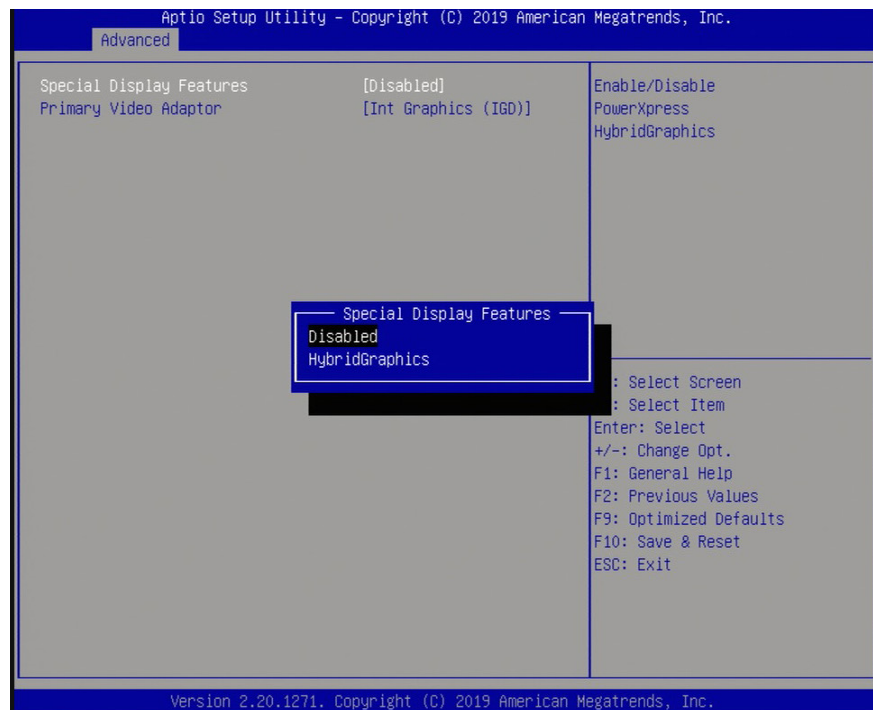

Special Display Features

Enable or disable AMD Hybrid Graphics technology, which allows the combined operation of IGP and the discrete GPU for better performance and power efficiency.

Primary Video Adaptor

Select the primary video adaptor: internal or external graphics.

Trusted Computing

This section configures security settings.

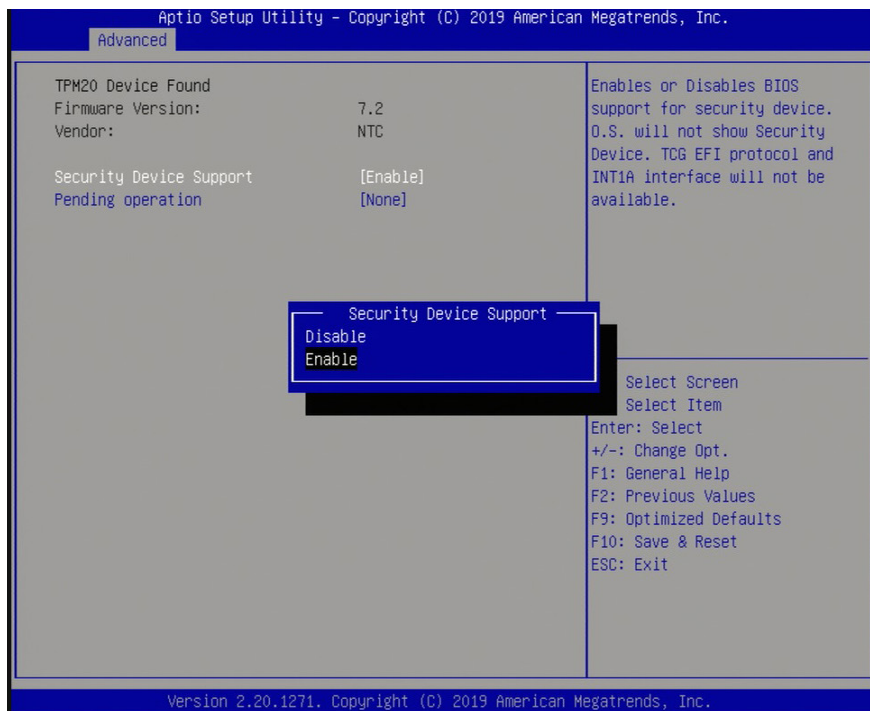

Security Device Support

Enable or disable the support for Trusted Platform Module (TPM) and allow the BIOS to automatically download the drivers needed to activate this function. After you have enabled this function, you can change the TPM state which allows different TPM operations.

Pending Operation

Schedule an operation for the security device.

ACPI Configuration

This section configures system ACPI parameters.

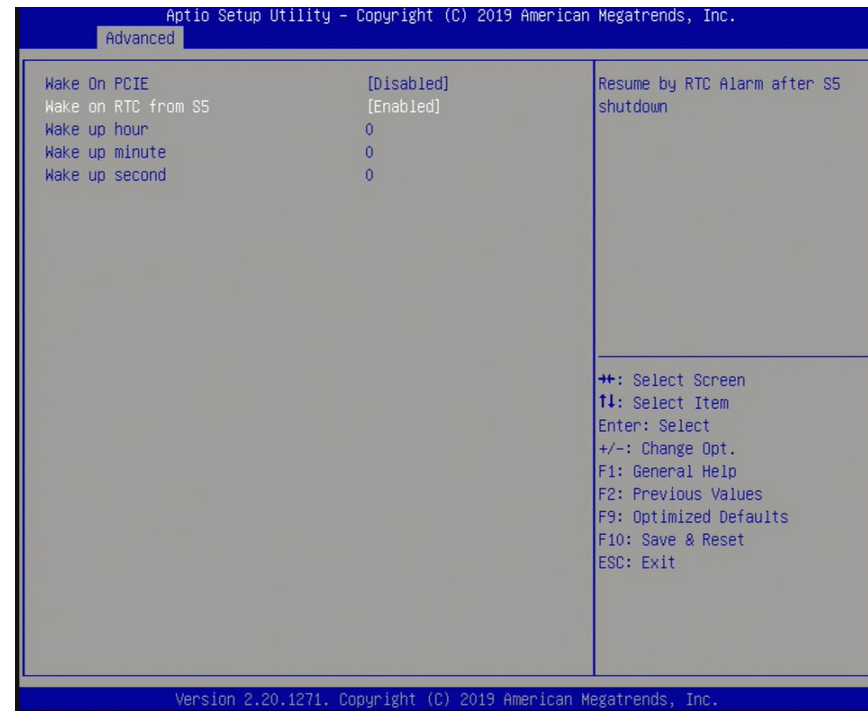

Wake on PCIE

Enable or disable automatic system wake-up using the integrated LAN.

Wake on RTC from S5

Enable or disable the resume on RTC alarm function, which automatically powers on the system from S5 power state (soft-off state) at the specified time every day. The default is disabled and enter the following wake-up time of the day:

Wake up hour Input any value between 0 and 23.

Wake up minute Input any value between 0 and 59.

Wake up second Input any value between 0 and 59.

CPU Configuration

This section configures the CPU.

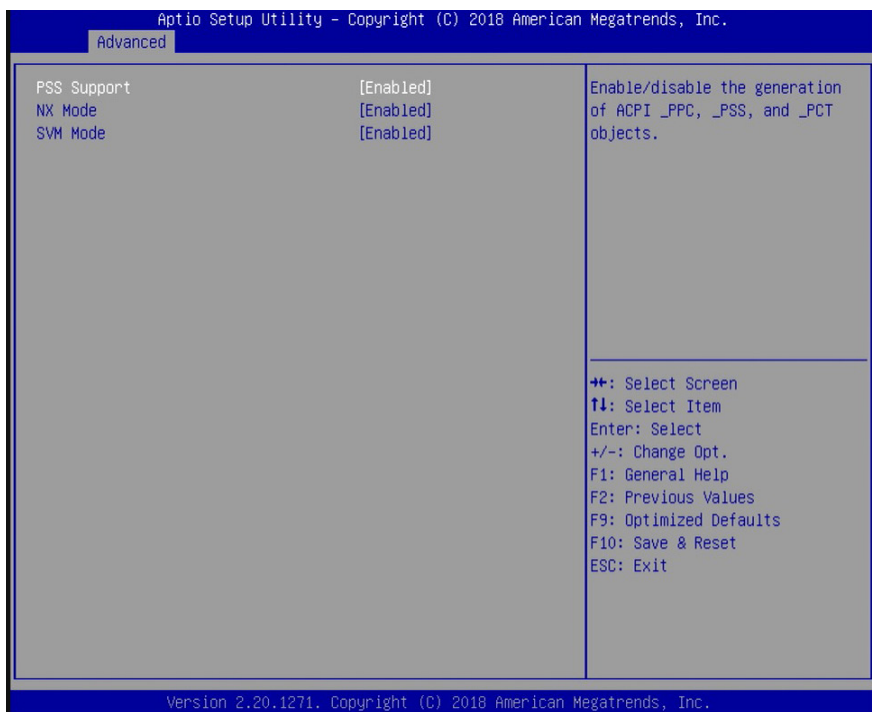

PSS Support

Enable or disable the generation of ACPI PPC, PSS, and PCT objects. These objects are associated with the operation of CPU P-state.

NX Mode

Enable or disable the non-execute page protection function.

SVM Mode

Enable or disable the CPU virtualization function.

Serial Port Console Redirection

Console redirection lets you monitor and control the system from a remote station by re-directing the host screen output through a serial port.

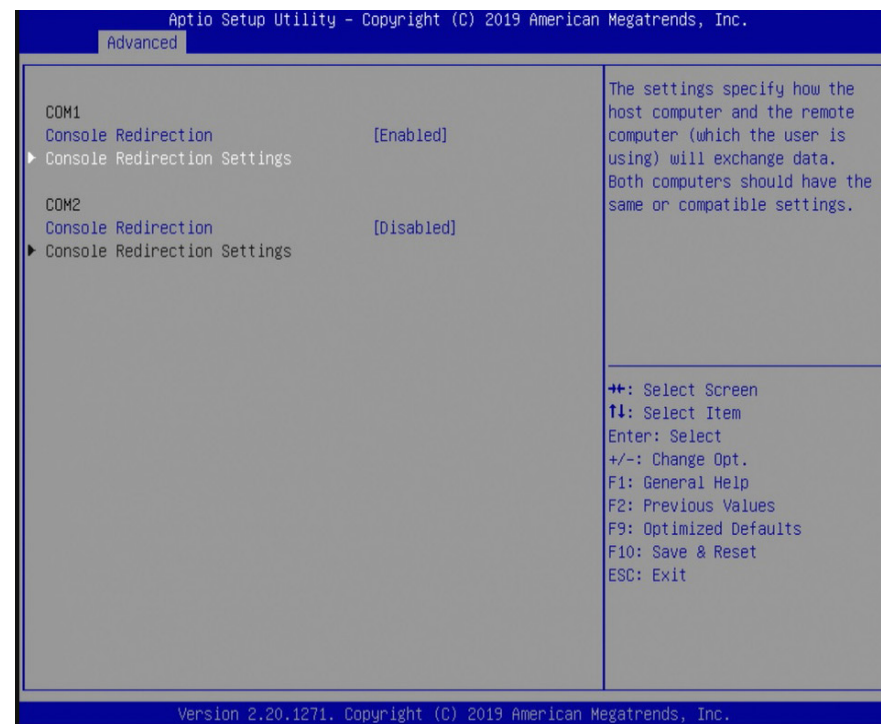

NCT6116D Super IO Configuration

This section configures the system super I/O chip parameters.

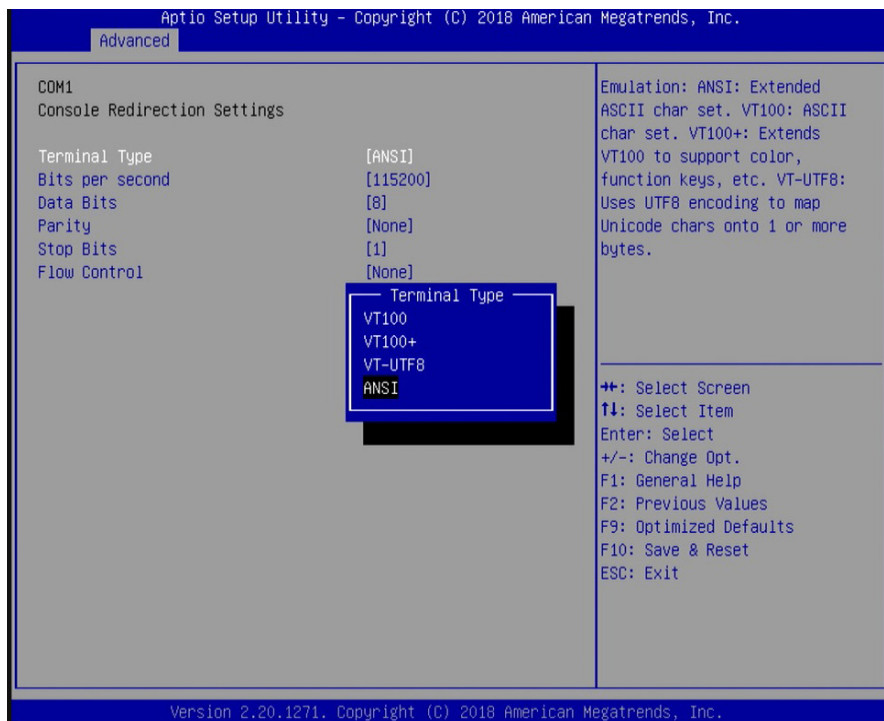
**Console Redirection Settings**

Enable or disable the console redirection function. (The default is disabled.) If you select to enable it, please configure the following parameters for serial communication between the system and a remote station:

Terminal type: VT100, VT100+, VT-UTF8, or ANSI.

Bits per second: 115200, 57600, 38400, 19200 or 9600.

Data bits: 8 bits or 7 bits.

Parity: None, Even or Odd.

Stop bits: 1 bit or 2 bits.

Flow control: None or Hardware RTS/CTS.

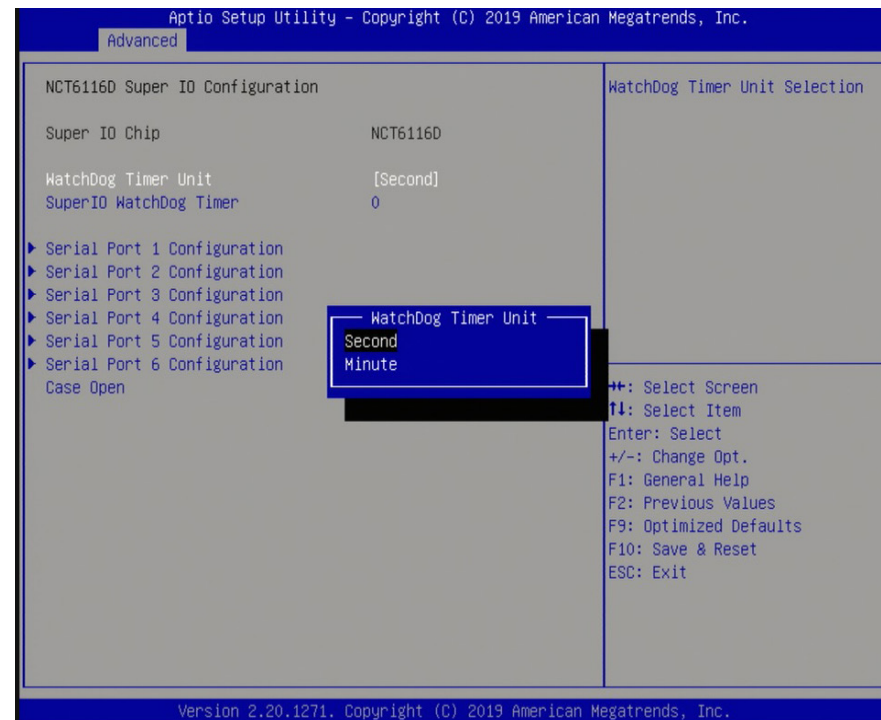
**WatchDog Timer Unit
SuperIO WatchDog Timer**

Enable or disable the watchdog function. A counter will appear if you select to enable the WDT. Input any value between 1 to 255 in the "SuperIO WatchDog Timer" field.

NCT6116D HW Monitor

This section displays the hardware health status.

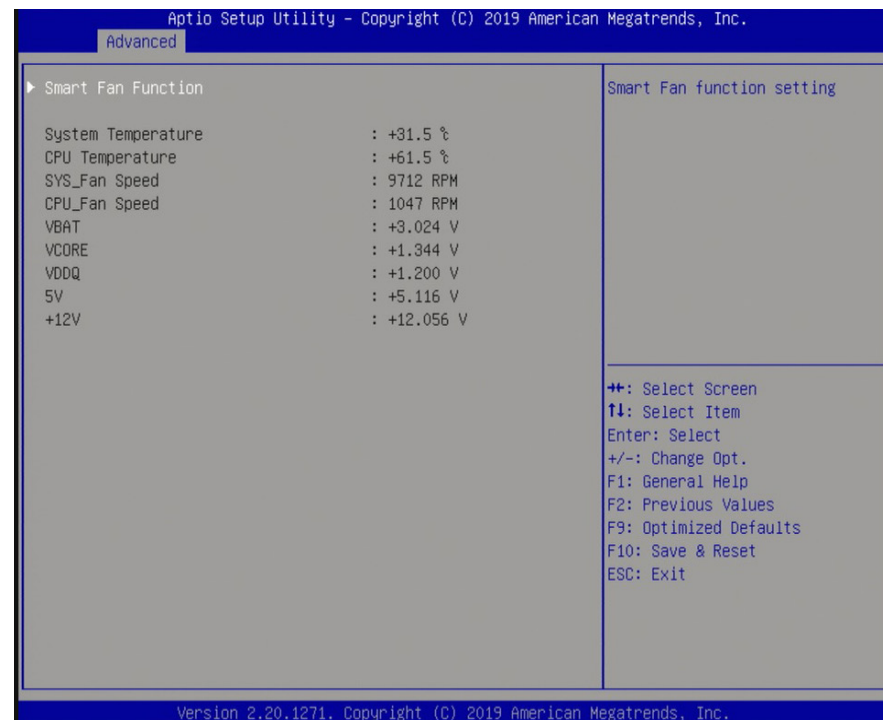
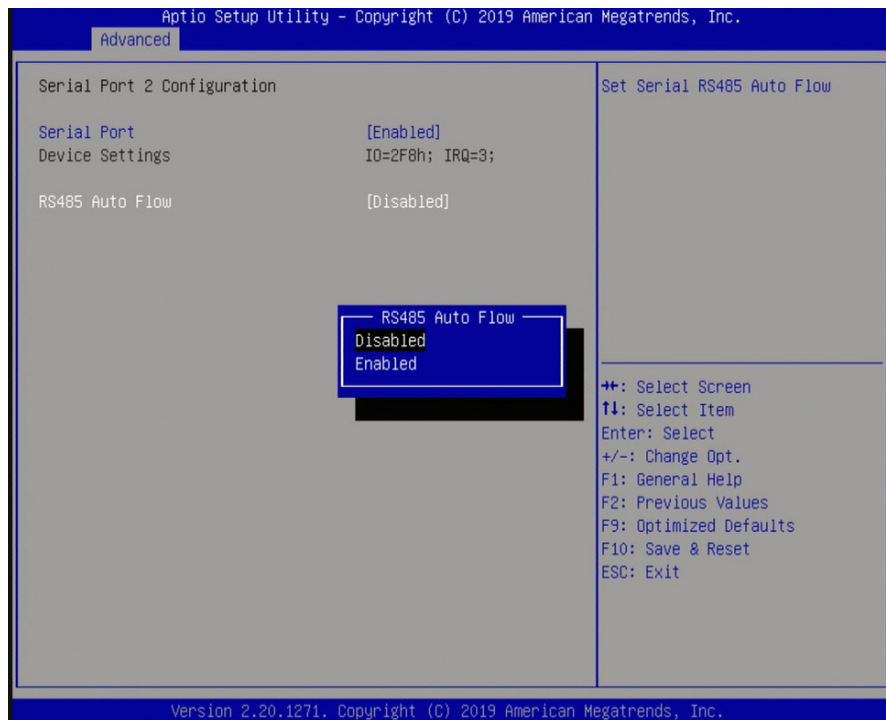
**Serial Port 1 to 6**

Enable or disable the serial port (COM).

Device Settings

It shows the IO/IRQ settings for the super I/O device.

RS485 Auto Flow (only available for Serial Port 2)

Enable or disable the auto flow mechanism for COM Port 2.

USB Configuration

This section configures the parameters of USB devices.

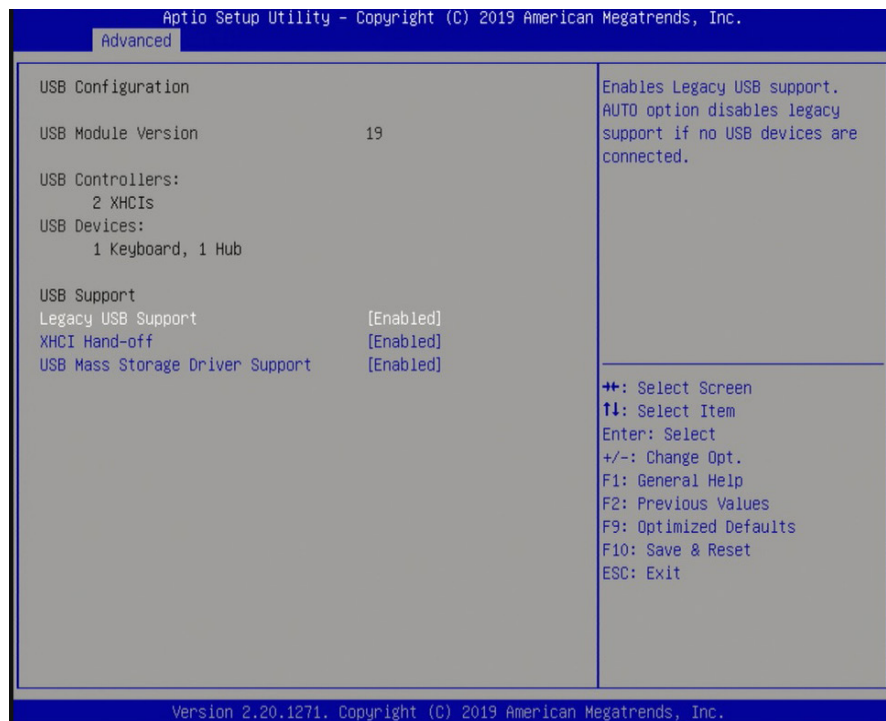

Legacy USB Support

Enabled

Enables legacy USB.

Disabled

Keeps USB devices available only for EFI applications.

XHCI Hand-off

This is a workaround for OSeS that do not support eXtensible Host Controller Interface (xHCI) hand-off. The xHCI ownership change should be claimed by the xHCI driver.

USB Mass Storage Driver Support

Enable or disable the support for the USB Mass Storage Driver.

Network Stack Configuration

This section configures network stack settings.



Enable or disable Network Stack which supports Preboot eXecution Environment (PXE) boot. The default is disabled.

When "Network Stack" is set to enabled, it displays the following configurations:

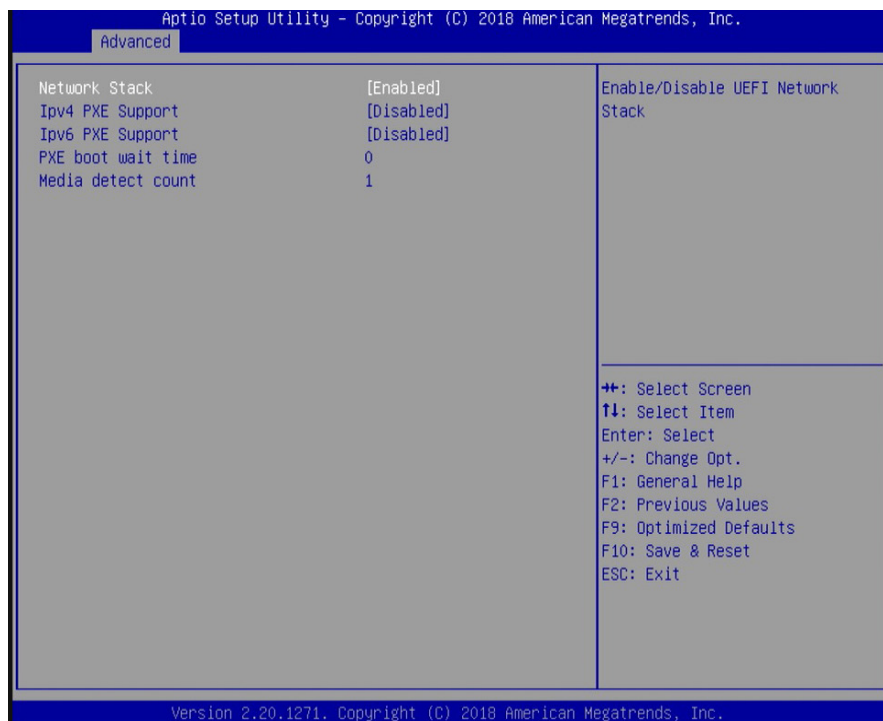

IPv4 PXE Support

Enable or disable Preboot eXecution Environment (PXE) boot to LAN using IPv4 addressing architecture.

IPv6 PXE Support

Enable or disable Preboot eXecution Environment (PXE) boot to LAN using IPv6 addressing architecture.

PXE boot wait time

Enter the wait time value (seconds) to abort the PXE boot by pressing the ESC key. Valid range is from 0 to 5 seconds.

Media detect count

Enter the number of times the presence of media will be checked. Valid range is from 1 to 50 times.

CSM Configuration

This section configures Compatibility Support Module (CSM) settings.

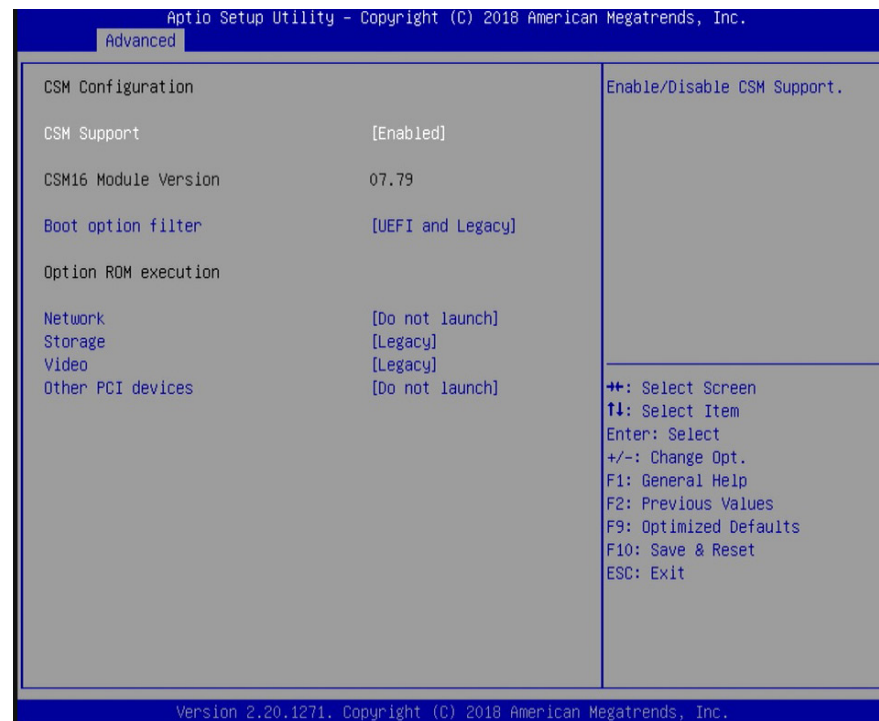

CSM Support

Enable or disable the CSM support (the default is enabled). When the CSM support is enabled, UEFI BIOS will be able to execute legacy firmware drivers. Note that the "Video" option of the CSM Configuration has to be in UEFI (*NOT legacy*) in order to disable CSM support.

Boot option filter

Select the BIOS boot mode: UEFI and legacy, legacy only or UEFI only.

Network

Select the execution mode of network option ROM: Do not launch, UEFI or legacy.



Note:

When Secure Boot (please refer to "Security"> "Secure Boot" later in this chapter) is enabled, execution of the CSM and legacy ROMs is not allowed.

Storage

Select the execution mode of storage option ROM: Do not launch, UEFI or legacy.

Video

Select the execution mode of video option ROM: Do not launch, UEFI or legacy.

Other PCI devices

Select the execution mode of option ROM for other PCI devices other than the above configured network, storage and video devices: Do not launch, UEFI or legacy.

Security

This section configures the security for system boot and BIOS setup utility.

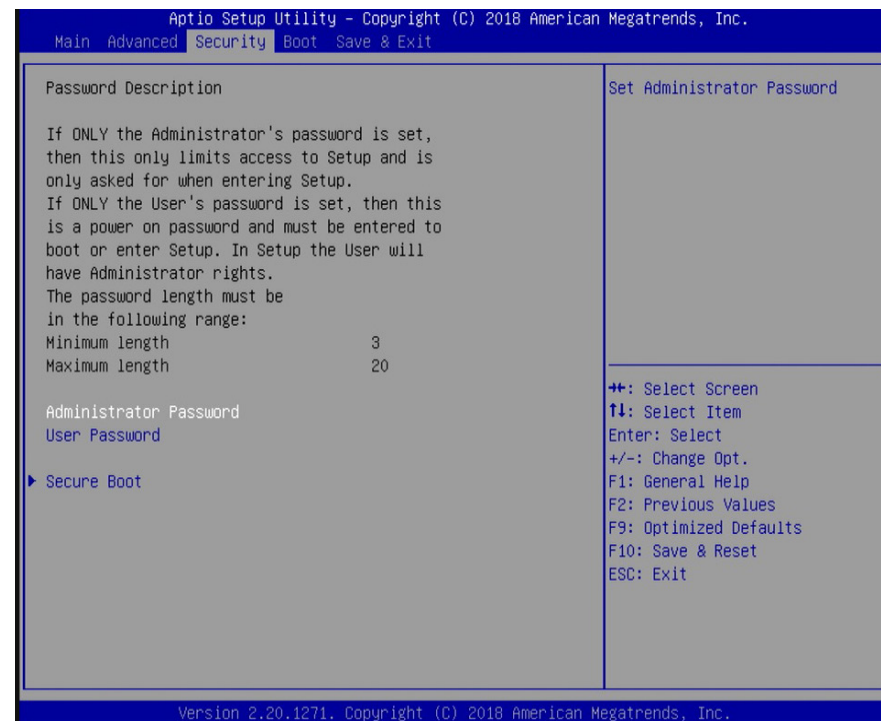

Administrator Password

Enter to set a new password or change the existing administrator password.

User Password

Enter to set a new password or change the existing user password.

Please note that passwords must be at least 3 and up to 20 characters long.

Secure Boot

This section configures Secure Boot settings. This function is designed for advanced users; be careful when changing these settings. It's possible to cause the system not to start properly.

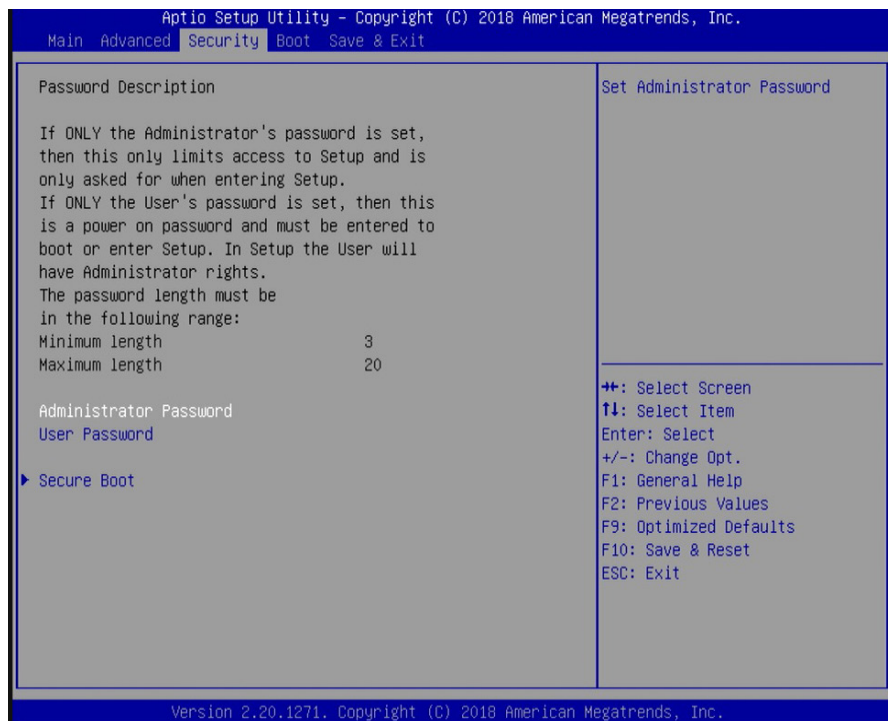

Secure Boot

Secure Boot ensures that the system executes only firmware that is trusted by the manufacturer during the boot process. This function can only be enabled if the Platform Key (PK) is enrolled, and the System Mode is User/Deployed (as opposed to the Setup Mode in which all database variables will be deleted and all of the pre-defined factory default keys are uninstalled) and the CSM (please refer to "Advanced" > "CSM Configuration" earlier in this chapter) is disabled.

Secure Boot Customization

Select Custom to customize the "Secure Boot" function or "Standard" to use the standard feature. If it is set to "Custom", the following functions can be configured:

Restore Factory Keys

Select "Yes" to force the system to use the factory defaults settings. It will set the system to be in the "User Mode". It will also configure the NVRAM to contain pre-defined factory default Secure Boot keys (Microsoft public keys). This is necessary for the signature database (DB) to load your Certification Authority certificates or public keys.

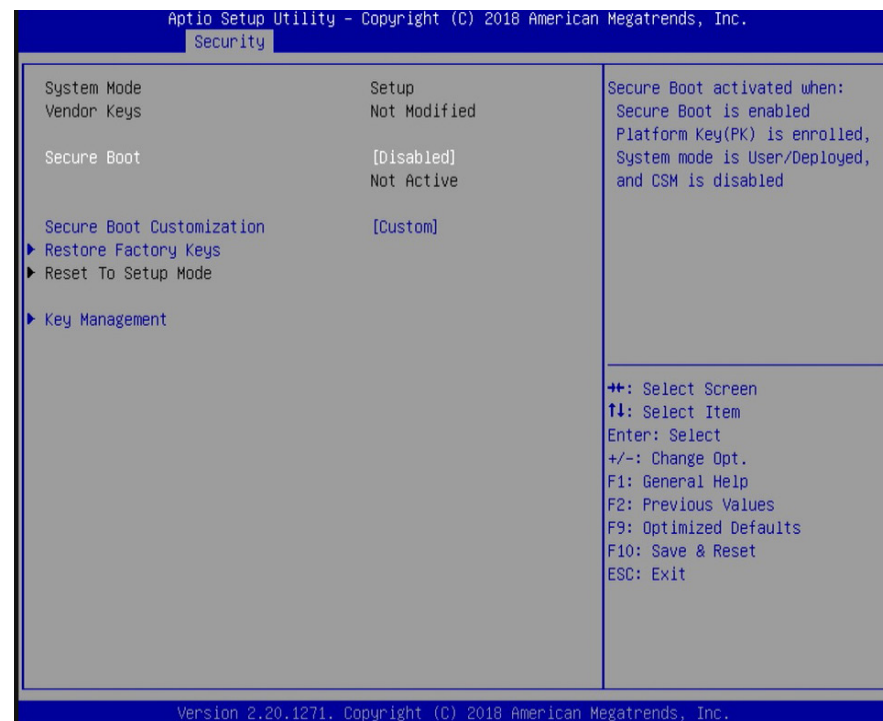

Reset To Setup Mode

Select "Yes" to delete all UEFI secure boot keys stored in the NVRAM. It will also revert the system back to the Setup mode.

Key Management

Manage Secure Boot keys such as Platform Key and Key Exchange Keys.



Note:

Please verify that system's date/time is correct for the public keys to be installed successfully. To set date and time, please go to the "Main" menu of the BIOS Setup Utility.

Key Management

This section creates and manages the Secure Boot keys and certificates.

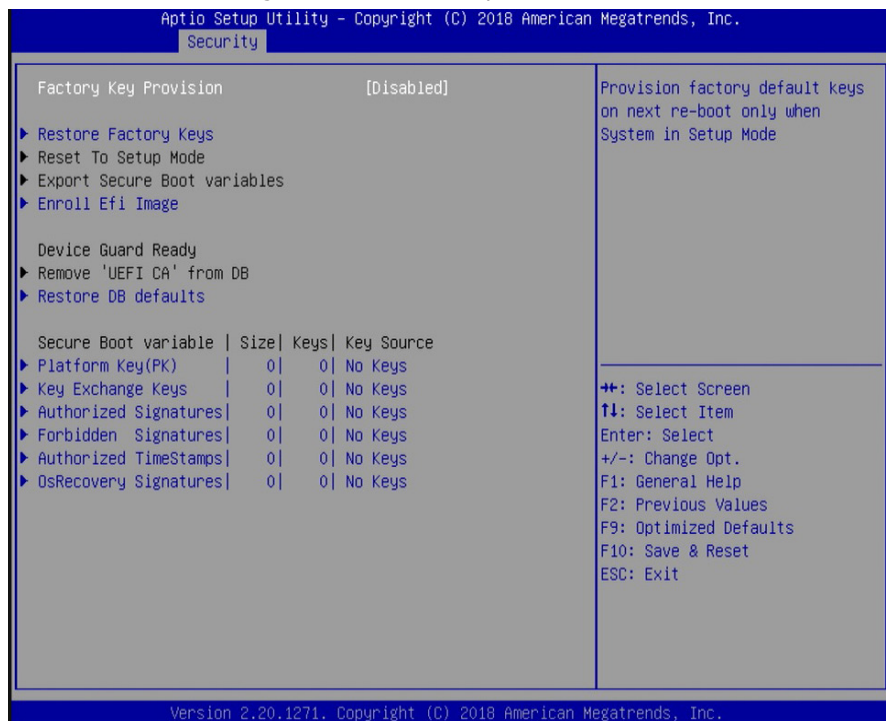

Factory Key Provision

When the system is in the Setup mode, you can provision the system with a configured factory default key.

Restore Factory Keys

Select "Yes" to force the system to restore all DB variables as well as the default keys from these databases: Platform Key (PK), KEK (Key Exchange Key) Database, Authorized Signatures (allowed signatures) Database, Forbidden Signatures (revoked signatures) Database, and Authorized Timestamps (Timestamping Database), and OS Recovery Signatures Database.

Reset To Setup Mode

Select "Yes" to delete all delete all DB variables and uninstall all Certification Authority certificates or public keys contained within.

Export Secure Boot Variables

Export the NVRAM content of Secure Boot configurations to a file in the root folder of a selected file system device.

Enroll Efi Image

Enroll a SHA256 certificate of a PE image into the authorized signature database (DB) to allow the image to run in the Secure Boot mode.

Remove UEFI CA from DB

Remove the Microsoft UEFI CA certificates from the authorized signature DB.

Restore DB defaults

Restore DB variables to their factory defaults. You may also proceed to the next section: "Secure Boot Variable" to configure DB variables, including Platform Key (PK), Key Exchange Keys, Authorized Signatures, Forbidden Signatures, Authorized TimeStamps, OsRecovery Signatures. For each variable, you can choose to show the detailed information of the key(s) and export, update, append or delete the key(s). For example, to install a Certification Authority certificate or a public Key, go to "Authorized Signatures", select "Append" to append a Certification Authority certificate or public key, and then select your certificate or public key stored in the USB drive.

Boot

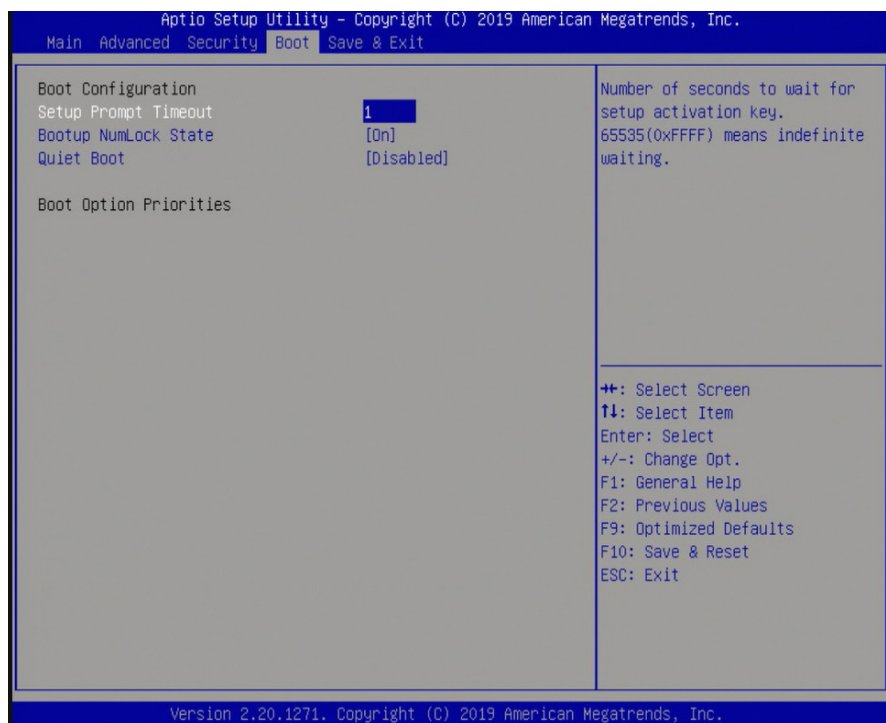

Setup Prompt Timeout

Select the number of seconds to wait for the BIOS setup activation key. 65535 (0xFFFF) denotes indefinite waiting.

Bootup NumLock State

This option allows you to determine the default state of the numeric keypad. By default, the system boots up with NumLock on and the function of the numeric keypad is the number keys. When it is set to Off, the function of the numeric keypad is the arrow keys.

Quiet Boot

Enable or disable the quiet boot function to configure the screen's display between POST messages or the OEM logo at bootup. Select Disabled to display the POST messages and select Enabled to display the OEM logo.

Boot Option #1/#2

Set the boot order of the system boot devices.

Hard Drive BBS Priorities

Set the boot order of the devices in this group.

Save & Exit

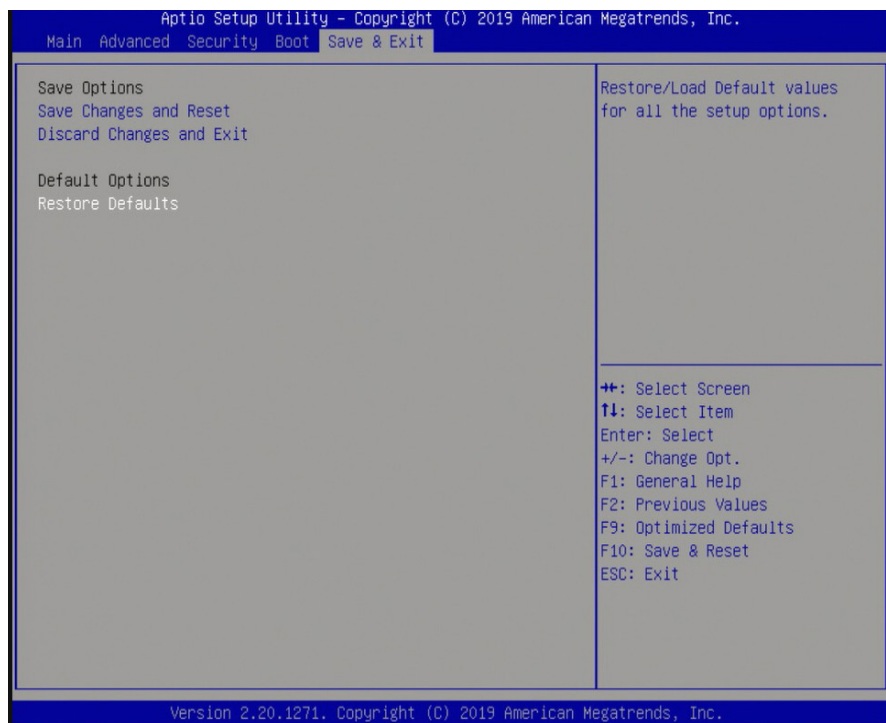

Save Changes and Reset

To save the changes, select this field and then press <Enter>. A dialog box will appear. Select "Yes" to reset the system after saving all changes.

Discard Changes and Exit

To discard the changes, select this field and then press <Enter>. A dialog box will appear. Select "Yes" to reset system setup configurations without saving any changes.

Restore Defaults

To restore and load the optimized default values, select this field and then press <Enter>. A dialog box will appear. Select "Yes" to restore the default values of all the setup options.

Updating the BIOS

To update the BIOS, you will need the new BIOS file and a flash utility. Please contact technical support or your sales representative for the latest BIOS file and the firmware update utility. For instructions on how to update BIOS with the flash utility, please see <https://www.dfi.com/tw/knowledge/video/5> from the Knowledge Base of the DFI website.

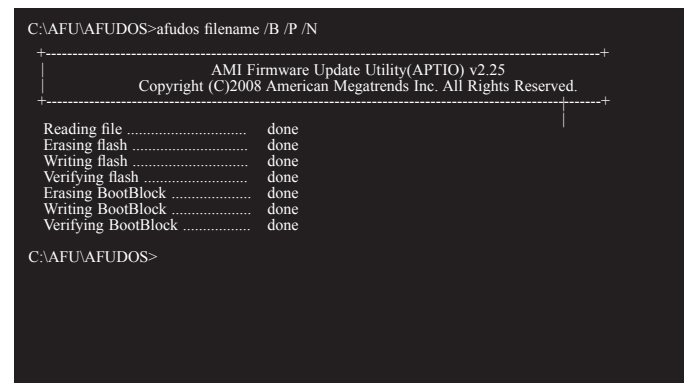

Chapter 8 - Supported Software

The system requires you to install drivers for some devices to operate properly. To download the latest driver, please go to the DFI Download Center:

<http://www.dfi.com/DownloadCenter>

Once you are in the Download Center page, select your product or type the model name and click "Search" to find product-related resources such as documentation and drivers.

Drivers are available for the following devices in Windows 10:

- AMD® Chipset and VGA Drivers
- Realtek RTL8111HN LAN Drivers

AMD® Chipset and VGA Drivers

The AMD Radeon™ software provides drivers and configuration utilities for AMD Radeon™ Vega 11 Graphics. To install this software, click the executable file to begin the installation.

1. Read the End User License Agreement then click "Accept and Install" to continue the installation or click on X to stop the installation.

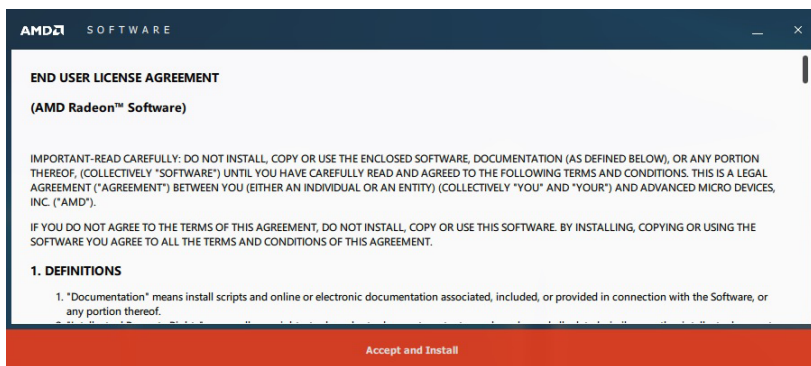

2. Choose between "Express Install" or "Custom Install". The "Express Install" installs all the programs in the default folder.

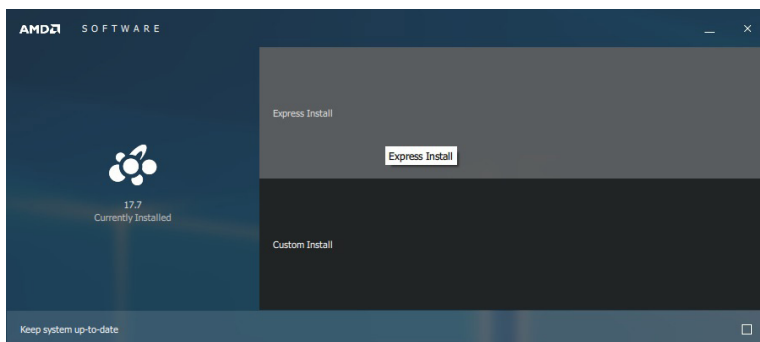

3. The "Custom Install" provides the option to select the programs that you would like to install and the folder for installation.

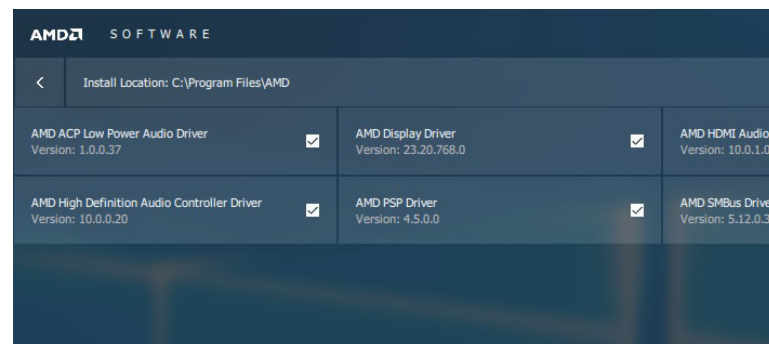

4. Please wait while the software and drivers are being installed.

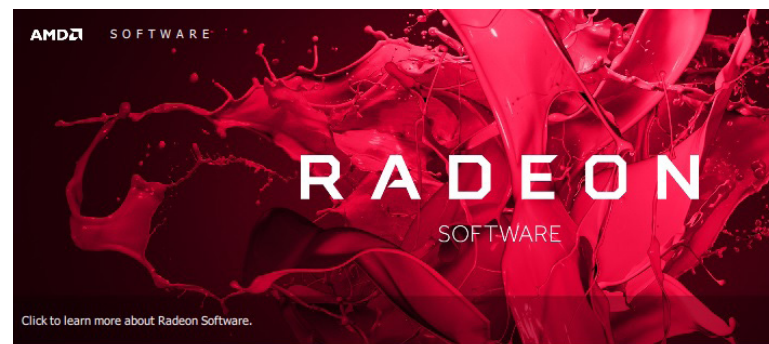

5. Once the Radeon™ Software has been successfully installed, choose "Restart Now".

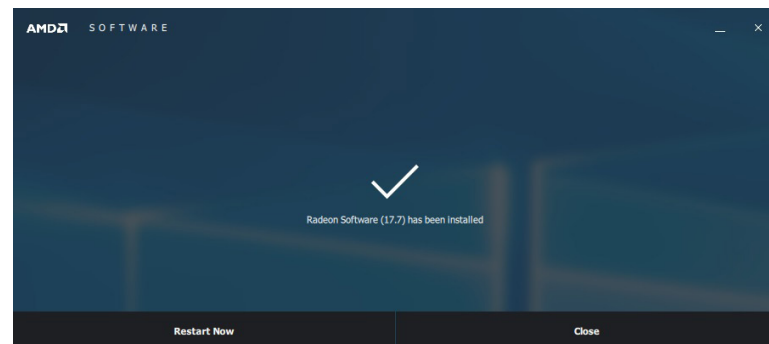

Realtek LAN Drivers

The onboard LAN ports are provided by Realtek Gigabit Ethernet controllers. To install the driver, click the executable file inside the LAN Driver folder.

1. After the software package has done preparing the software package, click "Next" to continue.

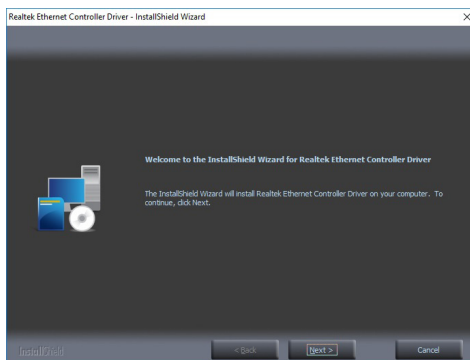

2. Click "Install" to start the installation.

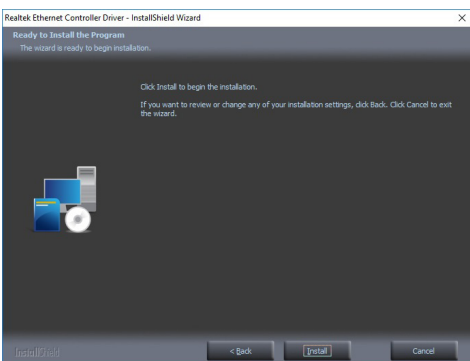

3. Click "Finish" to exit the wizard after the installation is complete.

