

**DFI**

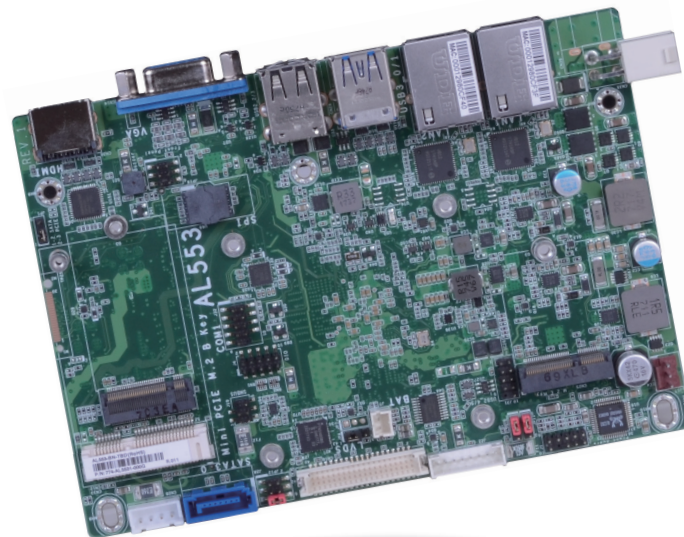

**AL553**  
**Embedded SBC 3.5"**  
**User's Manual**

## Copyright

This publication contains information that is protected by copyright. No part of it may be reproduced in any form or by any means or used to make any transformation/adaptation without the prior written permission from the copyright holders.

This publication is provided for informational purposes only. The manufacturer makes no representations or warranties with respect to the contents or use of this manual and specifically disclaims any express or implied warranties of merchantability or fitness for any particular purpose. The user will assume the entire risk of the use or the results of the use of this document. Further, the manufacturer reserves the right to revise this publication and make changes to its contents at any time, without obligation to notify any person or entity of such revisions or changes.

Changes after the publication's first release will be based on the product's revision. The website will always provide the most updated information.

© 2019. All Rights Reserved.

## Trademarks

Product names or trademarks appearing in this manual are for identification purpose only and are the properties of the respective owners.

## FCC and DOC Statement on Class B

This equipment has been tested and found to comply with the limits for a Class B digital device, pursuant to Part 15 of the FCC rules. These limits are designed to provide reasonable protection against harmful interference when the equipment is operated in a residential installation. This equipment generates, uses and can radiate radio frequency energy and, if not installed and used in accordance with the instruction manual, may cause harmful interference to radio communications. However, there is no guarantee that interference will not occur in a particular installation. If this equipment does cause harmful interference to radio or television reception, which can be determined by turning the equipment off and on, the user is encouraged to try to correct the interference by one or more of the following measures:

- Reorient or relocate the receiving antenna.
- Increase the separation between the equipment and the receiver.
- Connect the equipment into an outlet on a circuit different from that to which the receiver is connected.
- Consult the dealer or an experienced radio TV technician for help.

### Notice:

1. The changes or modifications not expressly approved by the party responsible for compliance could void the user's authority to operate the equipment.
2. Shielded interface cables must be used in order to comply with the emission limits.

# Table of Contents

Copyright.....	2
Trademarks .....	2
FCC and DOC Statement on Class B.....	2
Warranty.....	4
Static Electricity Precautions.....	4
Safety Measures .....	4
About the Package.....	5
Optional Items.....	5
Before Using the System Board.....	5
Chapter 1 - Introduction .....	6
Specifications .....	6
Features.....	7
Chapter 2 - Hardware Installation.....	8
Board Layout.....	8
Block Diagram.....	9
Mechanical Drawing .....	9
System Memory.....	10
Installing the SODIMM Module .....	10
Jumper Settings .....	11
Clear CMOS Data.....	11
LCD/Inverter Power Select .....	12
Backlight Brightness Select.....	12
Panel Power Select .....	13
M.2 Signal Select.....	13
Rear Panel I/O Ports.....	14
9~36V DC-in .....	14
Graphics Interfaces .....	15
RJ45 LAN Ports.....	15
USB Ports.....	16
I/O Connectors .....	17
Digital I/O Connector.....	17
Front Audio Connector .....	17
COM (Serial) Port .....	18

Standby Power LED .....	19
Front Panel Connector .....	19
SATA (Serial ATA) Connector .....	20
SATA (Serial ATA) Power Connector .....	20
LVDS LCD Panel Connector .....	21
LCD/Inverter Power Connector .....	21
SMBus Connector .....	22
Expansion Slots .....	22
Cooling Fan Connector .....	23
Battery.....	23

Chapter 3 - BIOS Setup .....	24
Overview.....	24
Insyde BIOS Setup Utility.....	25
Main .....	25
Advanced .....	25
Security.....	33
Boot.....	34
Exit.....	35
Updating the BIOS .....	35
Notice: BIOS SPI ROM .....	36
Chapter 4 - Supported Software .....	37
Appendix A - Troubleshooting Checklist.....	43

## Warranty

1. Warranty does not cover damages or failures that arised from misuse of the product, inability to use the product, unauthorized replacement or alteration of components and product specifications.
2. The warranty is void if the product has been subjected to physical abuse, improper installation, modification, accidents or unauthorized repair of the product.
3. Unless otherwise instructed in this user's manual, the user may not, under any circumstances, attempt to perform service, adjustments or repairs on the product, whether in or out of warranty. It must be returned to the purchase point, factory or authorized service agency for all such work.
4. We will not be liable for any indirect, special, incidental or consequential damages to the product that has been modified or altered.

## Static Electricity Precautions

It is quite easy to inadvertently damage your PC, system board, components or devices even before installing them in your system unit. Static electrical discharge can damage computer components without causing any signs of physical damage. You must take extra care in handling them to ensure against electrostatic build-up.

1. To prevent electrostatic build-up, leave the system board in its anti-static bag until you are ready to install it.
2. Wear an antistatic wrist strap.
3. Do all preparation work on a static-free surface.
4. Hold the device only by its edges. Be careful not to touch any of the components, contacts or connections.
5. Avoid touching the pins or contacts on all modules and connectors. Hold modules or connectors by their ends.



### Important:

Electrostatic discharge (ESD) can damage your processor, disk drive and other components. Perform the upgrade instruction procedures described at an ESD workstation only. If such a station is not available, you can provide some ESD protection by wearing an antistatic wrist strap and attaching it to a metal part of the system chassis. If a wrist strap is unavailable, establish and maintain contact with the system chassis throughout any procedures requiring ESD protection.

## Safety Measures

To avoid damage to the system:

- Use the correct AC input voltage range.

To reduce the risk of electric shock:

- Unplug the power cord before removing the system chassis cover for installation or servicing. After installation or servicing, cover the system chassis before plugging the power cord.

## About the Package

The package contains the following items. If any of these items are missing or damaged, please contact your dealer or sales representative for assistance.

- One AL553 board
- One COM port cable (Length: 250mm, 1 x COM port)
- One SATA data cable (Length: 500mm)
- One SATA power cable (Length: 250mm)
- One Heat sink (Height: 35mm)

## Optional Items

- COM port cable (Length: 250mm, 1 x COM port)
- Power adapter (60W, 12V)
- Heat spreader for AL55x E-Serial CPU
- Heat spreader for AL55x N-Serial CPU
- Audio cable (Length: 160mm)
- USB port cable (Length: 200mm)

The board and accessories in the package may not come similar to the information listed above. This may differ in accordance to the sales region or models in which it was sold. For more information about the standard package in your region, please contact your dealer or sales representative.

## Before Using the System Board

Before using the system board, prepare basic system components.

If you are installing the system board in a new system, you will need at least the following internal components.

- Storage devices such as hard disk drive, etc.

You will also need external system peripherals you intend to use which will normally include at least a keyboard, a mouse and a video display monitor.

## Chapter 1 - Introduction

### Specifications

<b>SYSTEM</b>	Processor	Intel Atom® Processor E3900 Family, BGA 1296 Intel Atom® x7-E3950 Processor, Quad Core, 2M Cache, 1.6GHz (2.0GHz), 12W Intel Atom® x5-E3940 Processor, Quad Core, 2M Cache, 1.6GHz (1.8GHz), 9.5W Intel Atom® x5-E3930 Processor, Dual Core, 2M Cache, 1.3GHz (1.8GHz), 6.5W Intel Pentium® Processor N4200, Quad Core, 2M Cache, 1.1GHz (2.5GHz), 6W Intel® Celeron® Processor N3350, Dual Core, 2M Cache, 1.1GHz (2.4GHz), 6W
	Memory	One 204-pin SODIMM up to 8GB Single Channel DDR3L 1866MHz
	BIOS	Insyde SPI 128Mbit (supports UEFI boot only)
	<b>GRAPHICS</b>	Controller Intel® HD Graphics
	Feature	OpenGL 4.2, Direct X 11.1, OpenCL 1.2, OGL ES 3.0 HW Decode: H.264, MPEG2, VC1, VP8, H.265, MPEG4 HW Encode: H.264, MPEG2, MPEG4
	Display	1 x VGA VGA: resolution up to 1920x1200 @ 60Hz 1 x LVDS LVDS: dual channel 24-bit, resolution up to 1920x1200 @ 60Hz 1 x HDMI HDMI: resolution up to 3840x2160 @ 30Hz
	Triple Displays	VGA + LVDS + HDMI
<b>EXPANSION</b>	Interface	1 x Full-size mini-PCIe (USB/PCIe) with SIM slot (option) 1 x M.2 B key 2242 (PCIe/USB 2.0/SATA 3.0) 1 x M.2 E key 2230 (USB/PCIe)
<b>AUDIO</b>	Audio Codec	Realtek ALC262
<b>ETHERNET</b>	Controller	2 x Intel® I210AT PCIe (10/100/1000Mbps) 2 x Intel® I210IT PCIe (10/100/1000Mbps) (available upon request)
<b>REAR I/O</b>	Ethernet	2 x GbE (RJ-45)
	USB	2 x USB 3.1 Gen1 2 x USB 2.0
	Display	1 x VGA 1 x HDMI 1 x LVDS
<b>INTERNAL I/O</b>	Serial	1 x RS-232/422/485 (2.0mm pitch)
	USB	2 x USB 2.0 (2.0mm pitch)
	Display	1 x LVDS LCD Panel Connector 1 x LCD/Inverter Power
	Audio	1 x Audio (Line-out/Mic-in)
	SATA	1 x SATA 3.0 (up to 6Gb/s) 1 x SATA Power
	DIO	1 x 8-bit DIO
	SMBus	1 x SMBus
<b>WATCHDOG TIMER</b>	Output & Interval	System Reset, Programmable via Software from 1 to 255 Seconds
<b>SECURITY</b>	TPM 2.0	fTPM2.0

<b>POWER</b>	Type	Wide Range 9~36V DC
	Connector	Right Angle Connector (4-pin) DC-in Jack (available upon request) Vertical Type Connector (4-pin) (available upon request)
	Consumption	Typical: 7W Max: 24W
	RTC Battery	CR2032 Coin Cell
<b>OS SUPPORT (UEFI ONLY)</b>		Windows 10 IoT Enterprise (64-bit) Ubuntu 16.04
<b>ENVIRONMENT</b>	Temperature	Operating: 0 to 60°C, -20 to 70°C, -40 to 85°C Storage: -40 to 85°C
	Humidity	Operating: 5 to 90% RH Storage: 5 to 90% RH
	MTBF	618,325 hrs @ 25°C; 396,245 hrs @ 45°C; 267,106 hrs @ 60°C
<b>MECHANICAL</b>	Dimensions	3.5" SBC Form Factor 146mm (5.75") x 102mm (4.02")
	Height	PCB: 1.6mm Top Side: 15.5mm, Bottom Side: 8.0mm
<b>CERTIFICATIONS</b>		CE, FCC Class B, RoHS

## Features

### • Watchdog Timer

The Watchdog Timer function allows your application to regularly “clear” the system at the set time interval. If the system hangs or fails to function, it will reset at the set time interval so that your system will continue to operate.

### • DDR3L

DDR3L requires less voltage (1.35V) than DDR3 (1.5V). DDR3L SDRAM modules support 1866MHz for DDR modules.

### • Graphics

The integrated Intel® HD graphics engine delivers an excellent blend of graphics performance and features to meet business needs. It provides excellent video and 3D graphics with outstanding graphics responsiveness. These enhancements deliver the performance and compatibility needed for today's and tomorrow's business applications. Supports 1 VGA, 1 LVDS and 1 HDMI interfaces for display outputs.

### • Serial ATA

Serial ATA is a storage interface that is compliant with SATA 1.0a specification. With speed of up to 6Gb/s (SATA 3.0), it improves hard drive performance faster than the standard parallel ATA whose data transfer rate is 100MB/s.

### • Gigabit LAN

Two Intel® I210AT PCI Express Gigabit Ethernet controllers or two optional Intel® I210IT PCI Express Gigabit Ethernet controllers support up to 1Gbps data transmission.

### • Audio

The Realtek ALC262 audio codec provides 4-channel DAC and 6-channel ADC High Definition audio output.

### • Power Failure Recovery

When power returns after an AC power failure, you may choose to either power-on the system manually or let the system power-on automatically.

### • USB

The system board supports the USB 3.1 Gen1. It is capable of running at a maximum transmission speed of up to 5 Gbit/s (625 MB/s) and is faster than USB 2.0 (480 Mbit/s, or 60 MB/s) and USB 1.1 (12Mb/s). USB 3.1 Gen1 reduces the time required for data transmission, reduces power consumption, and is backward compatible with USB 2.0. It is a marked improvement in device transfer speeds between your computer and a wide range of simultaneously accessible external Plug and Play peripherals.

### • Wake-On-LAN

This feature allows the network to remotely wake up a Soft Power Down (Soft-Off) PC. It is supported via the onboard LAN port or via a PCI LAN card that uses the PCI PME (Power Management Event) signal. However, if your system is in the Suspend mode, you can power-on the system only through an IRQ or DMA interrupt.

### • Wake-On-USB

This function allows you to use a USB keyboard or USB mouse to wake up a system from the S3 (STR - Suspend To RAM) state.

### • ACPI STR

The system board is designed to meet the ACPI (Advanced Configuration and Power Interface) specification. ACPI has energy saving features that enable PCs to implement power management and plug-and-play with operating systems that support power management features.

With ACPI, the system can further utilize the Ethernet adapter's wake-on-LAN (WOL) capability that enables remote wake-up if the Ethernet adapter supports such feature.

# Chapter 2 - Hardware Installation

## Board Layout

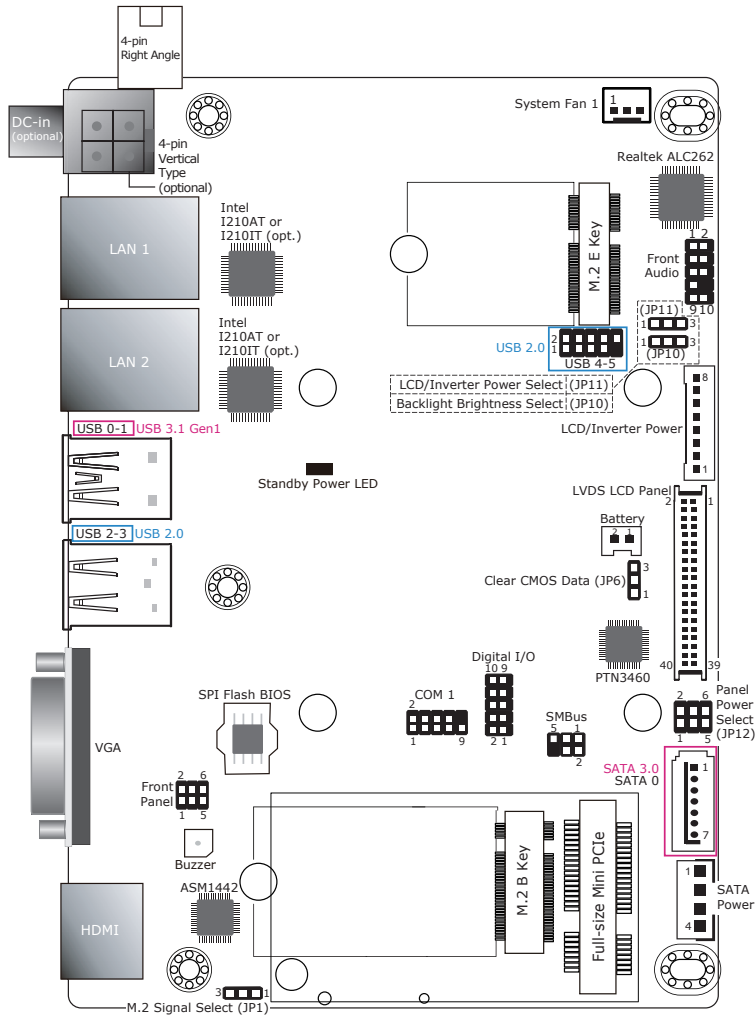

Top View

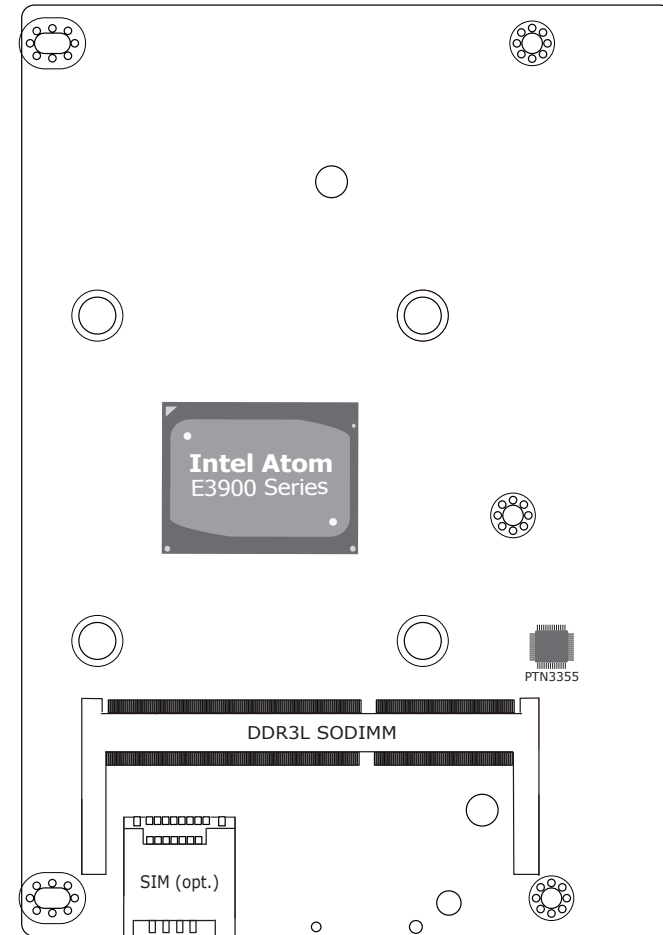

Bottom View



Block Diagram

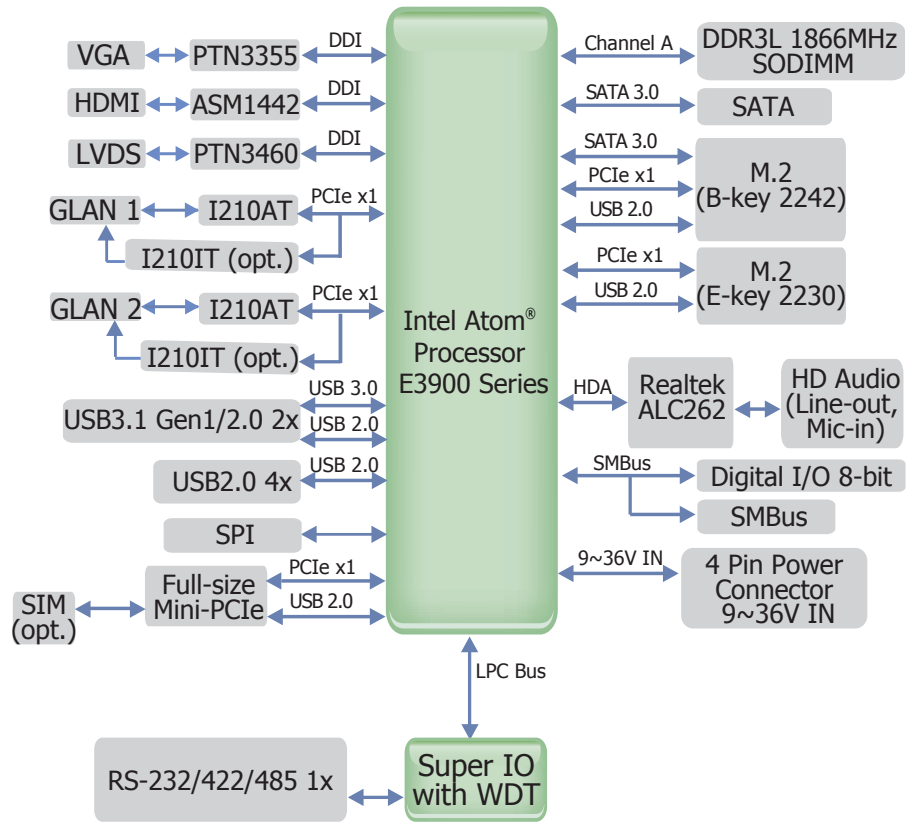

Mechanical Drawing

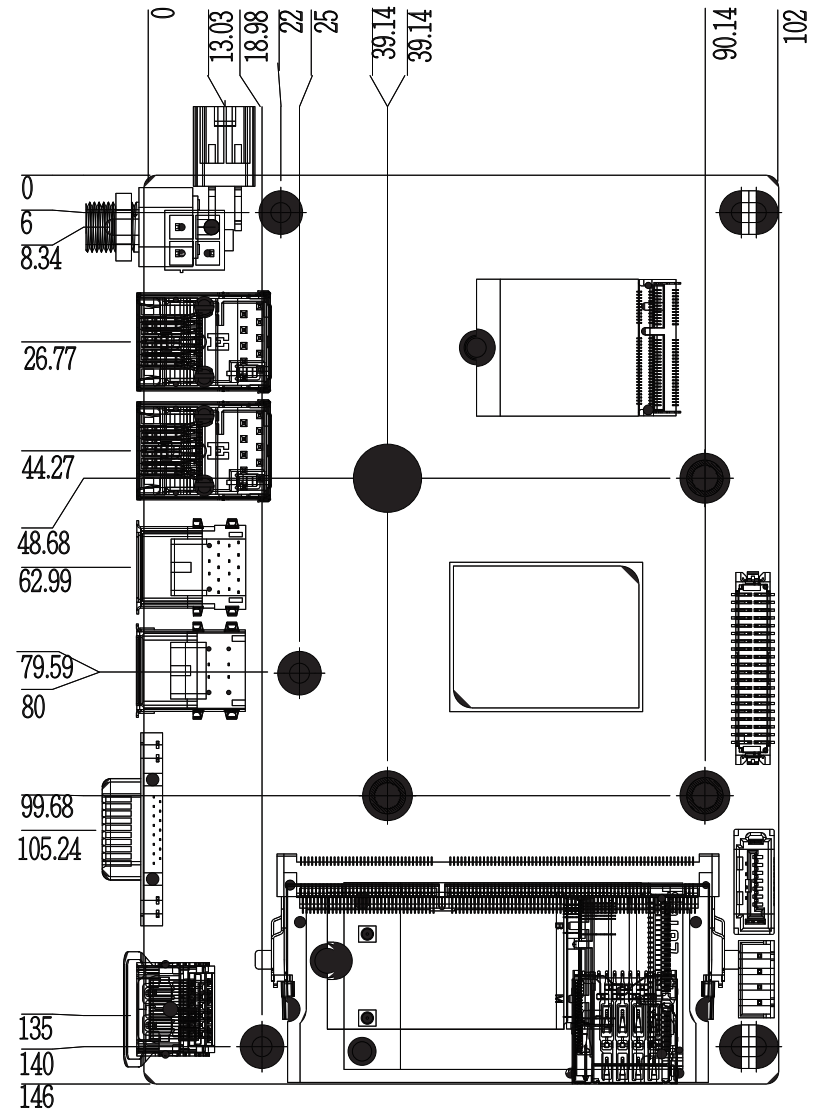

**Important:**

Electrostatic discharge (ESD) can damage your board, processor, disk drives, add-in boards, and other components. Perform installation procedures at an ESD workstation only. If such a station is not available, you can provide some ESD protection by wearing an antistatic wrist strap and attaching it to a metal part of the system chassis. If a wrist strap is unavailable, establish and maintain contact with the system chassis throughout any procedures requiring ESD protection.

**System Memory****Important:**

When the Standby Power LED lights red, it indicates that there is power on the system board. Power-off the PC then unplug the power cord prior to installing any devices. Failure to do so will cause severe damage to the motherboard and components.

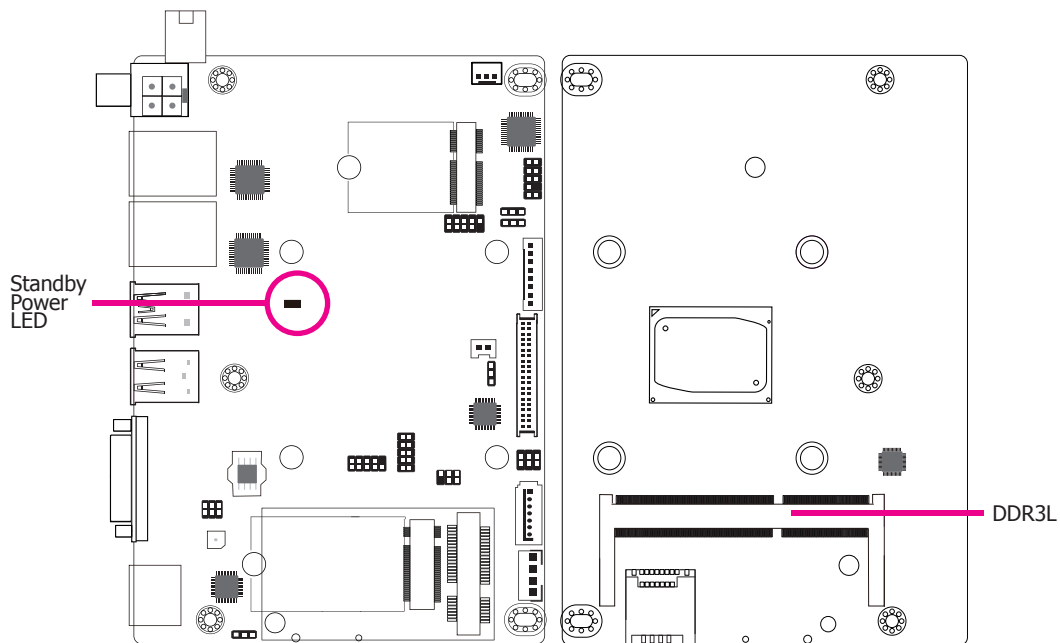
**Features**

- One 204-pin SODIMM up to 8GB
- Single Channel DDR3L 1866MHz

**Installing the SODIMM Module****Note:**

The system board used in the following illustrations may not resemble the actual board. These illustrations are for reference only.

1. Make sure the PC and all other peripheral devices connected to it has been powered down.
2. Disconnect all power cords and cables.
3. Locate the SODIMM socket on the system board.
4. Note the key on the socket. The key ensures the module can be plugged into the socket in only one direction.

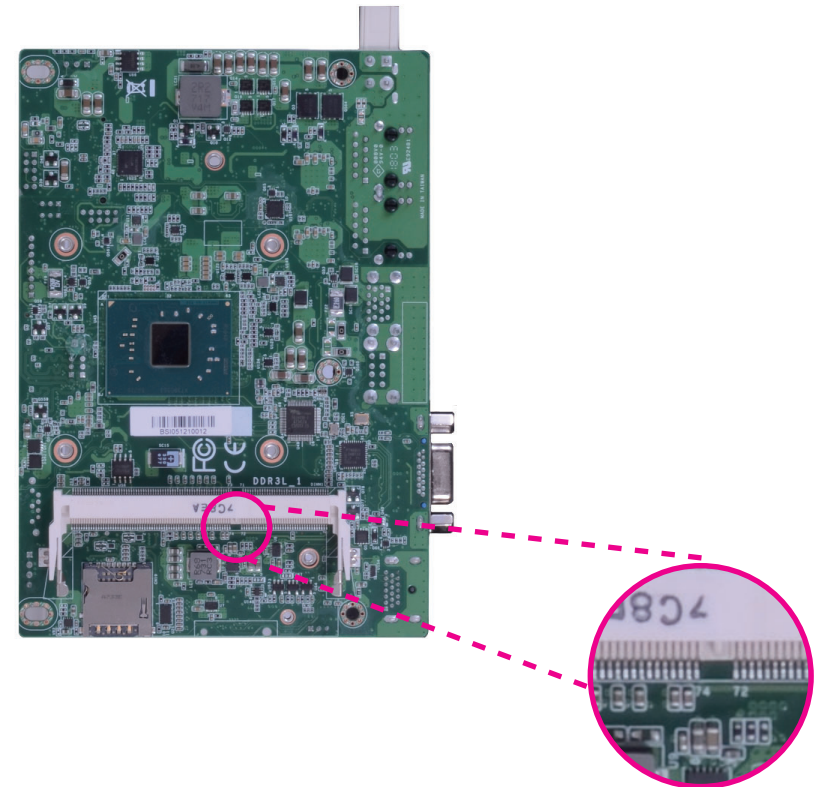

5. Grasping the module by its edges, align the module into the socket at an approximately 30 degrees angle. Apply firm even pressure to each end of the module until it slips down into the socket. The contact fingers on the edge of the module will almost completely disappear inside the socket.

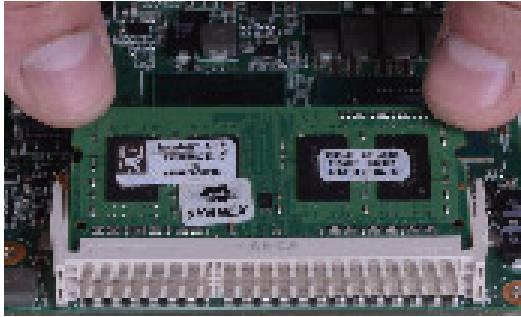

6. Push down the module until the clips at each end of the socket lock into position. You will hear a distinctive "click", indicating the module is correctly locked into position.



## Jumper Settings

### Clear CMOS Data

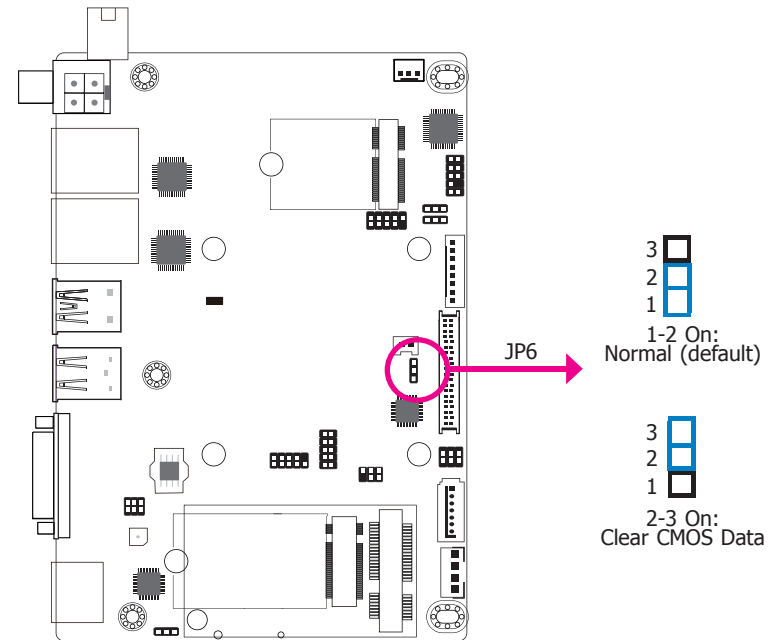

If you encounter the following conditions, you can reconfigure the system with the default values stored in the ROM BIOS.

- CMOS data becomes corrupted.
- You forgot the supervisor or user password.

To load the default values stored in the ROM BIOS, please follow these steps below.

- Power-off the system and unplug the power cord.
- Set JP6 pins 2 and 3 to On. Wait for a few seconds and set JP6 back to its default setting, pins 1 and 2 On.
- Now plug the power cord and power-on the system.

## LCD/Inverter Power Select

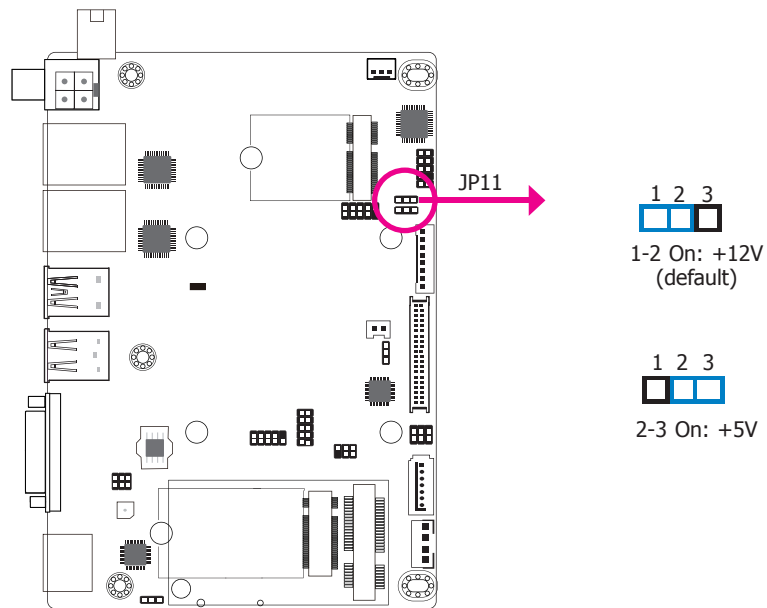

JP11 is used to select the power level of LVDS LCD inverter connector.

## Backlight Brightness Select

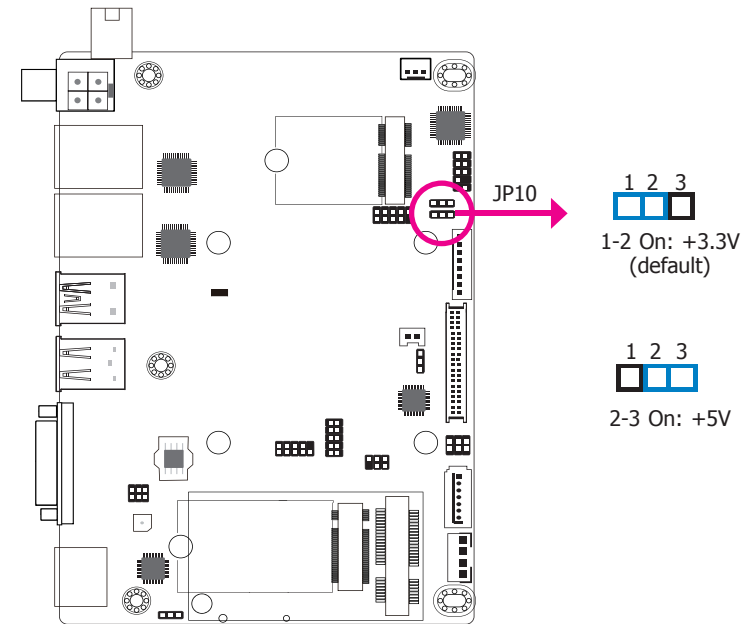

JP10 is used to select the power level of backlight brightness control: +3.3V or +5V.

**Important:**

Before powering-on the system, make sure that the power settings of JP10 match the power specification of backlight control. Selecting the incorrect voltage will seriously damage the backlight.

### Panel Power Select

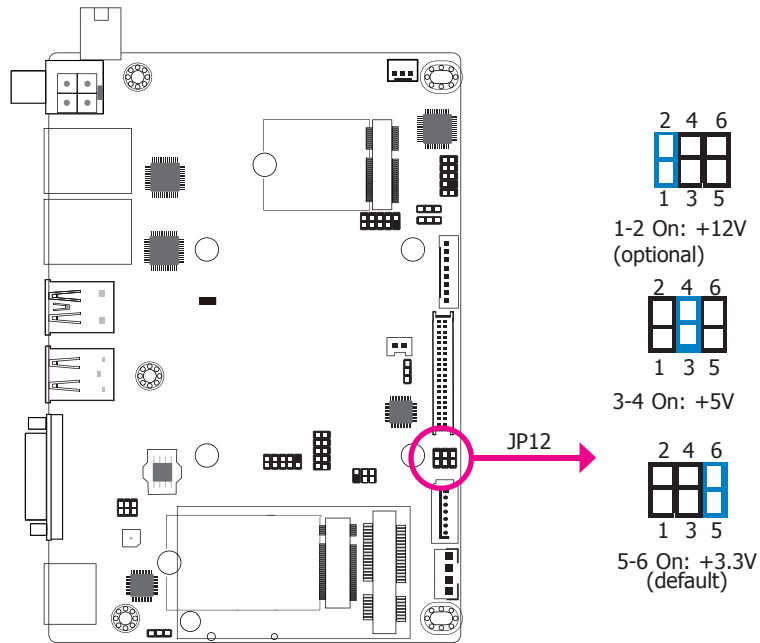

JP12 is used to select the power supplied with the LCD panel.

### M.2 Signal Select

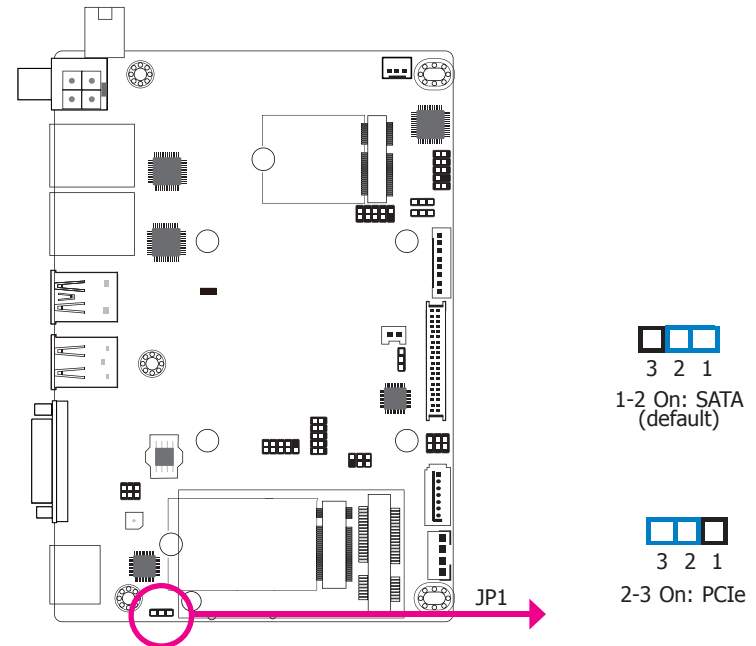

JP1 is used to select the M.2 B key signal: SATA (default) or PCIe.



**Important:**

Before powering-on the system, make sure that the power settings of JP12 match the LCD panel's specification. Selecting the incorrect voltage will seriously damage the LCD panel.

## Rear Panel I/O Ports

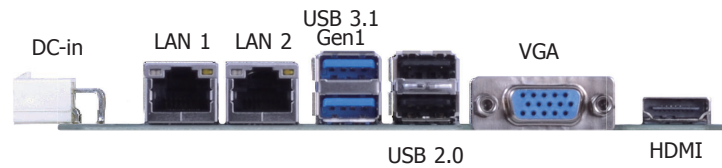

The rear panel I/O ports consist of the following:

- 1 9~36V DC-in connector
- 2 GbE (RJ-45)
- 2 USB 3.1 Gen1 ports
- 2 USB 2.0 ports
- 1 VGA port
- 1 HDMI port

## 9~36V DC-in

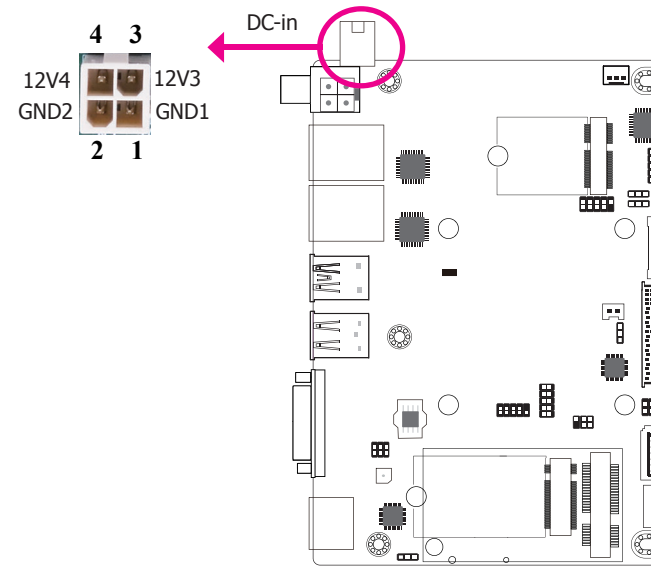

This 4-pin right angle connector is considered a low power solution. Connect a DC power cord to this connector. Using a voltage more than the recommended range may fail to boot the system or cause damage to the system board.

The 4-pin right-angle connector on the system board co-lays with a DC-in jack (optional) or 4-pin vertical type connector (optional) as the photo displayed below.

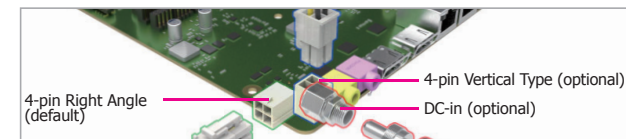

## Graphics Interfaces

The display ports consist of the following:

- 1 VGA port
- 1 HDMI port

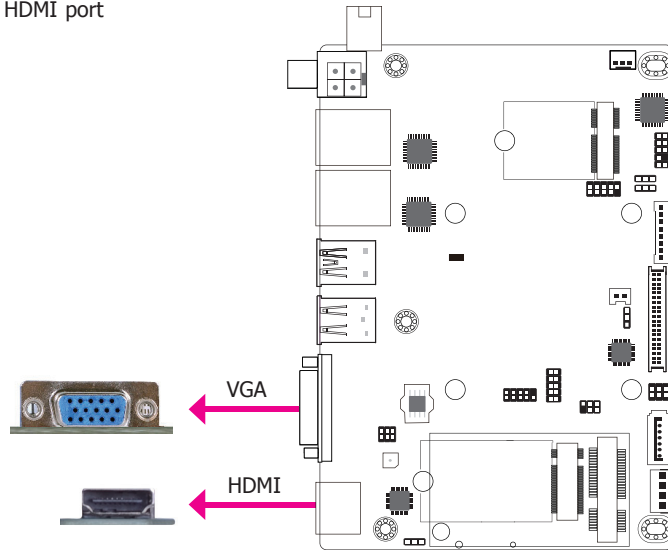

### VGA Port

The VGA port is used for connecting a VGA monitor. Connect the monitor's 15-pin D-shell cable connector to the VGA port. After you plug the monitor's cable connector into the VGA port, gently tighten the cable screws to hold the connector in place.

### HDMI Port

The HDMI port which carries both digital audio and video signals is used to connect a LCD monitor or digital TV that has the HDMI port.

### Driver Installation

Install the graphics driver. Refer to Chapter 4 for more information.

## RJ45 LAN Ports

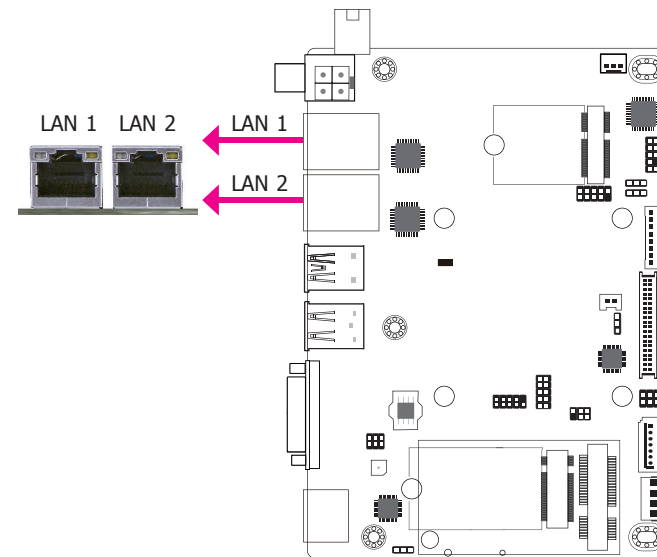

### Features

- 2 Intel® I210AT PCI Express Gigabit Ethernet controllers or 2 optional Intel® I210IT PCI Express Gigabit Ethernet controllers

The LAN ports allow the system board to connect to a local area network with a network hub.

### BIOS Setting

Configure the onboard LAN in the Advanced menu ("ACPI Configuration" submenu) of the BIOS. Refer to Chapter 3 for more information.

### Driver Installation

Install the LAN drivers. Refer to Chapter 4 for more information.

## USB Ports

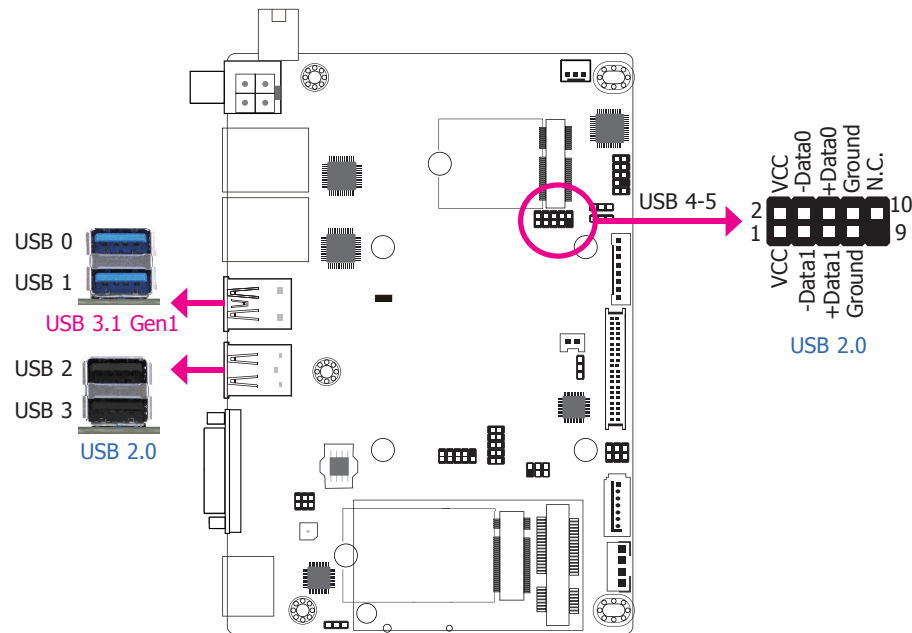

The USB device allows data exchange between your computer and a wide range of simultaneously accessible external Plug and Play peripherals.

The system board is equipped with 2 onboard USB 3.1 Gen1 ports (USB 0-1) and 2 onboard USB 2.0 ports (USB 2-3). The 10-pin connector allows you to connect 2 additional USB 2.0 ports (USB 4-5). The additional USB ports may be mounted on a card-edge bracket. Install the card-edge bracket to an available slot at the rear of the system chassis and then insert the USB port cables to a connector.

### BIOS Setting

Configure the onboard USB in the Boot menu ("USB Boot" field) of the BIOS. Refer to Chapter 3 for more information.

### Wake-On-USB Keyboard/Mouse

The Wake-On-USB Keyboard/Mouse function allows you to use a USB keyboard or USB mouse to wake up a system from the S3 (STR - Suspend To RAM) state.



## I/O Connectors

### Digital I/O Connector

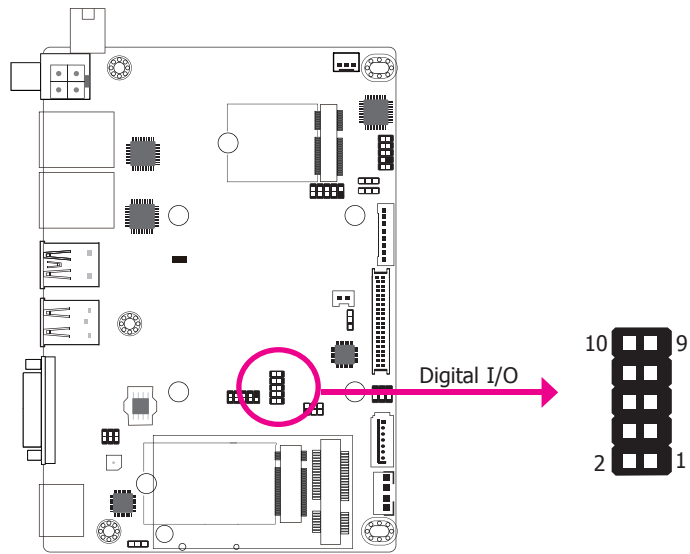

The 8-bit Digital I/O connector provides monitoring and control functions to the connected external devices.

#### Digital I/O Connector

Pin	Function
1	DIO7
2	DIO6
3	DIO5
4	DIO4
5	DIO3
6	DIO2
7	DIO1
8	DIO0
9	5V
10	GND

### Front Audio Connector

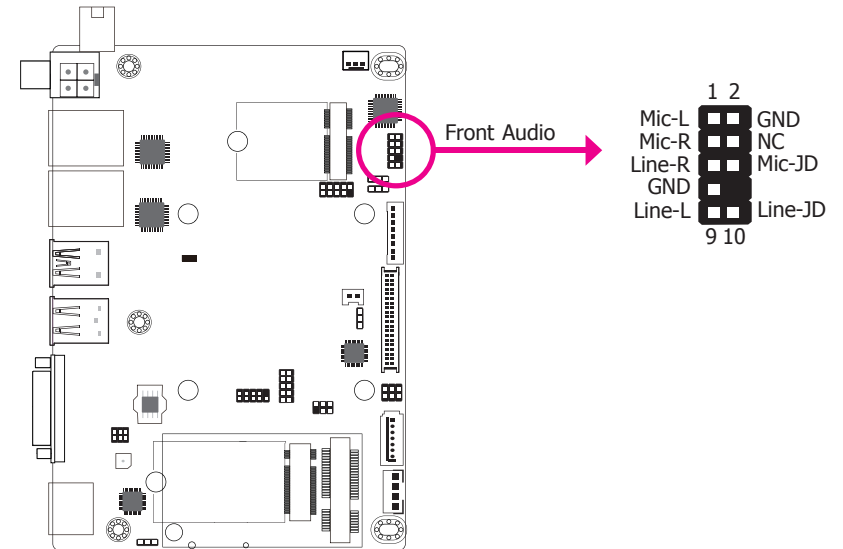

#### Front Audio

The front audio connector allows you to connect to the line-out and mic-in jacks that are at the front panel of your system.

#### Driver Installation

Install the audio driver. Refer to the Chapter 4 for more information.

## COM (Serial) Port

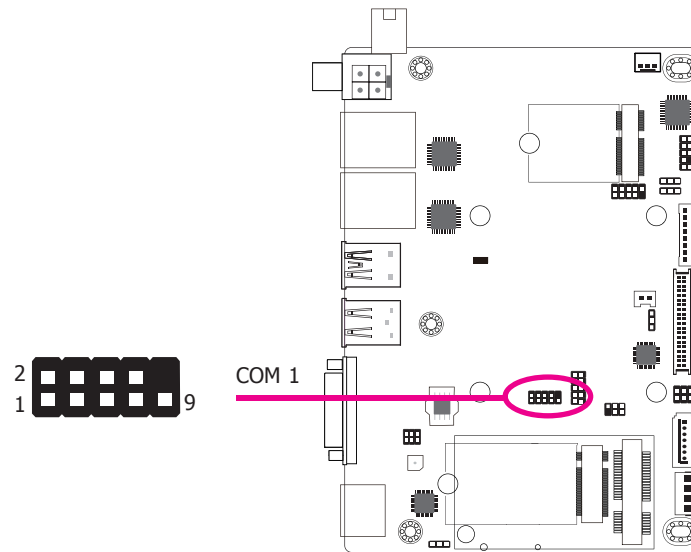

### COM 1

Pin	RS232	RS422 Full Duplex	RS485
1	DCD	TX-	DATA-
2	RD	TX+	DATA+
3	TD	RX+	NC
4	DTR	RX-	NC
5	GND	GND	GND
6	DSR	NC	NC
7	RTS	NC	NC
8	CTS	NC	NC
9	RI	NC	NC

COM 1 can be selected among RS232, RS422 and RS485 via BIOS.

The serial port is an asynchronous communication port with 16C550A-compatible UART that can be used with modems, serial printers, remote display terminals, and other serial devices.

### Connecting External Serial Ports

Your COM port may come mounted on a card-edge bracket. Install the card-edge bracket to an available slot at the rear of the system chassis then insert the serial port cable to the COM connector. Make sure the colored stripe on the ribbon cable is aligned with pin 1 of the COM connector.

### BIOS Setting

Configure the serial COM port in the Advanced menu ("SIO FINTEK81803" submenu) of the BIOS. Refer to the Chapter 3 for more information.

### Standby Power LED

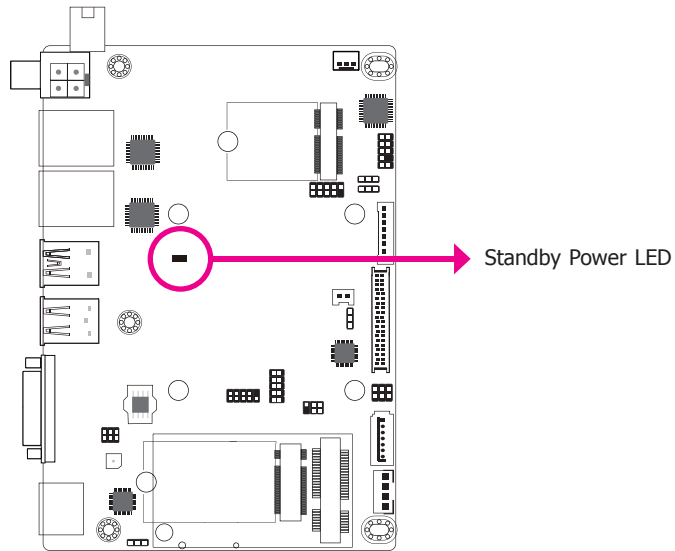

This LED will lit red when the system is in the standby mode. It indicates that there is power on the system board. Power-off the PC and then unplug the power cord prior to installing any devices. Failure to do so will cause severe damage to the motherboard and components.

### Front Panel Connector

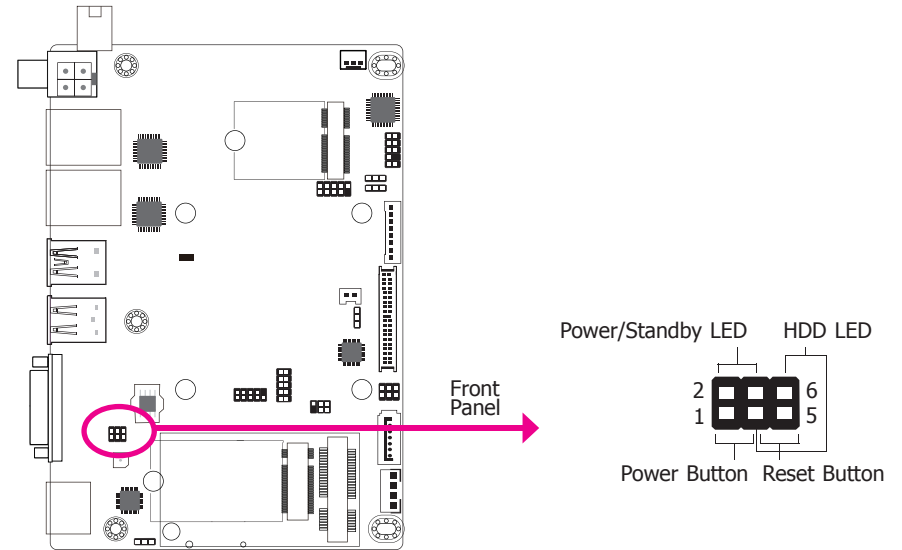

#### Power/Standby LED

When the system's power is on, this LED will be lit. When the system is in the S1 (POS - Power On Suspend) state, it will blink every second. When the system is in the S3 (STR - Suspend To RAM) state, it will blink every 4 seconds.

#### HDD LED

This LED will light when the hard drive is being accessed.

#### Power Button

This switch is used to power on or off the system.

#### Reset Button

This switch allows you to reboot without having to power off the system.

	Pin	Pin Assignment		Pin	Pin Assignment
<b>Power/Standby LED</b>	2	V_SUS_LED	<b>Power Button</b>	1	Power Button
	4	SUS_LED		3	GND
<b>HDD LED</b>	3	GND	<b>Reset Button</b>	3	GND
	6	HDD_LED		5	Reset Button

## SATA (Serial ATA) Connector

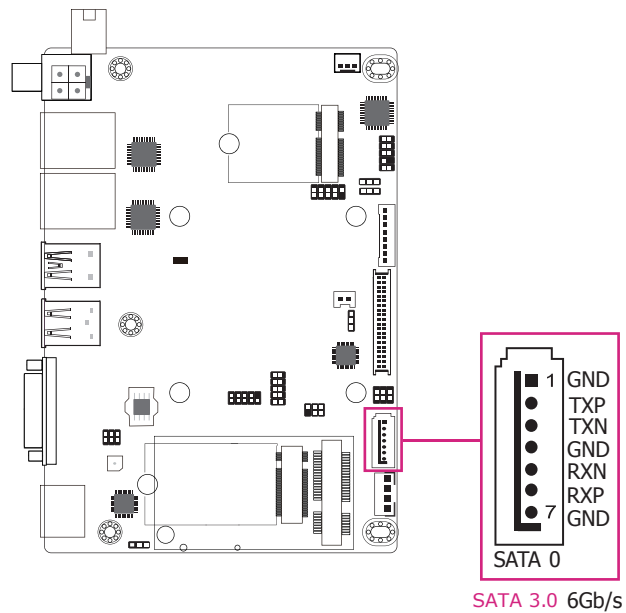

### Features

- 1 Serial ATA 3.0 port with data transfer rate up to 6Gb/s
- Integrated Advanced Host Controller Interface (AHCI) controller

The Serial ATA connector is used to connect the Serial ATA device. Connect one end of the Serial ATA data cable to a SATA connector and the other end to your Serial ATA device.

### BIOS Setting

Configure the Serial ATA drive in the Advanced menu ("SATA Configuration" submenu) of the BIOS. Refer to Chapter 3 for more information.

## SATA (Serial ATA) Power Connector

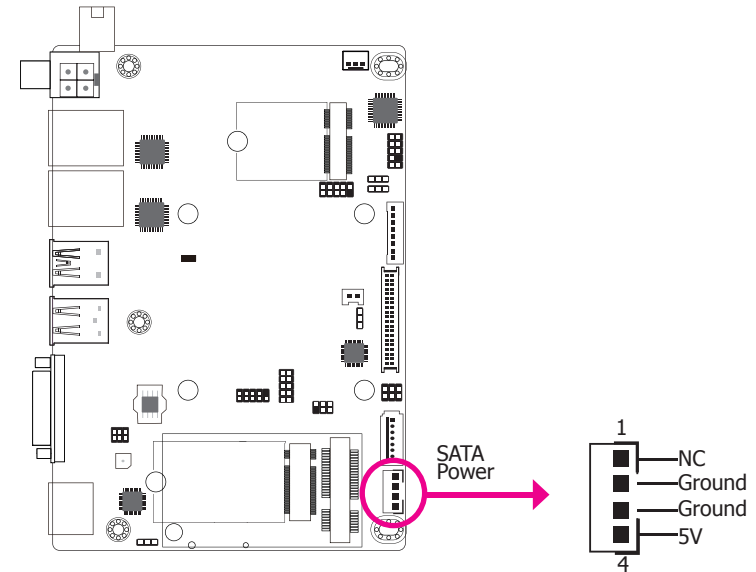

The SATA power connector supplies power to the SATA drive. Connect one end of the provided power cable to the SATA power connector and the other end to your storage device.

## LVDS LCD Panel Connector

## LCD/Inverter Power Connector

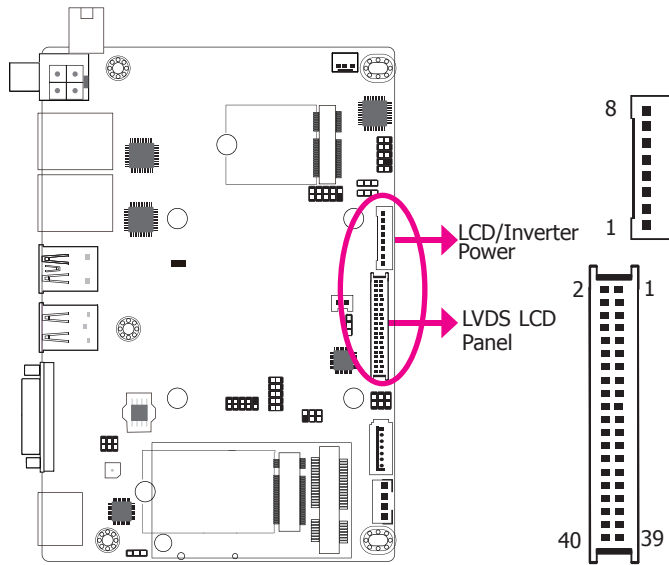

The system board allows you to connect a LCD Display Panel with the LVDS LCD panel connector and the LCD/Inverter power connector. These connectors transmit video signals and power from the system board to the LCD Display Panel.

Refer to the right side for the pin functions of these connectors.

### BIOS Setting

Configure the LCD panel in the Advanced menu ("Video Configuration" sub-menu) of the BIOS. Refer to Chapter 3 for more information.

## LVDS LCD Panel Connector

Pin	Function	Pin	Function
1	GND	2	GND
3	LVDS_Out3+ (Odd_3+)	4	LVDS_Out7+ (Even_3+)
5	LVDS_Out3- (Odd_3-)	6	LVDS_Out7- (Even_3-)
7	GND	8	GND
9	LVDS_Out2+ (Odd_2+)	10	LVDS_Out6+ (Even_2+)
11	LVDS_Out2- (Odd_2-)	12	LVDS_Out6- (Even_2-)
13	GND	14	GND
15	LVDS_Out1+ (Odd_1+)	16	LVDS_Out5+ (Even_1+)
17	LVDS_Out1- (Odd_1-)	18	LVDS_Out5- (Even_1-)
19	GND	20	GND
21	LVDS_Out0+ (Odd_0+)	22	LVDS_Out4+ (Even_0+)
23	LVDS_Out0- (Odd_0-)	24	LVDS_Out4- (Even_0-)
25	GND	26	GND
27	LVDS_CLK1+ (Odd_CLK+)	28	LVDS_CLK2+ (Even_CLK+)
29	LVDS_CLK1- (Odd_CLK-)	30	LVDS_CLK2- (Even_CLK-)
31	GND	32	GND
33	DDC_CLK	34	N.C.
35	DDC_DATA	36	+3.3V
37	Panel Power	38	Panel Power
39	Panel Power	40	Panel Power

## LCD/Inverter Power Connector

Pin	Function
1	GND
2	GND
3	Dimming Control
4	Panel Power
5	+3.3V
6	Panel Backlight On/Off Control
7	LCD/Inverter Power
8	LCD/Inverter Power

## SMBus Connector

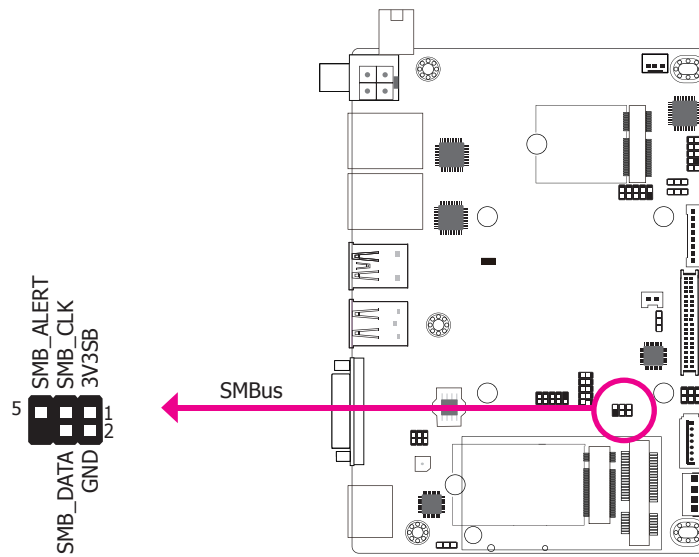

The SMBus (System Management Bus) connector is used to connect SMBus devices. It is a multiple device bus that allows multiple chips to connect to the same bus and enable each one to act as a master by initiating data transfer.

## Expansion Slots

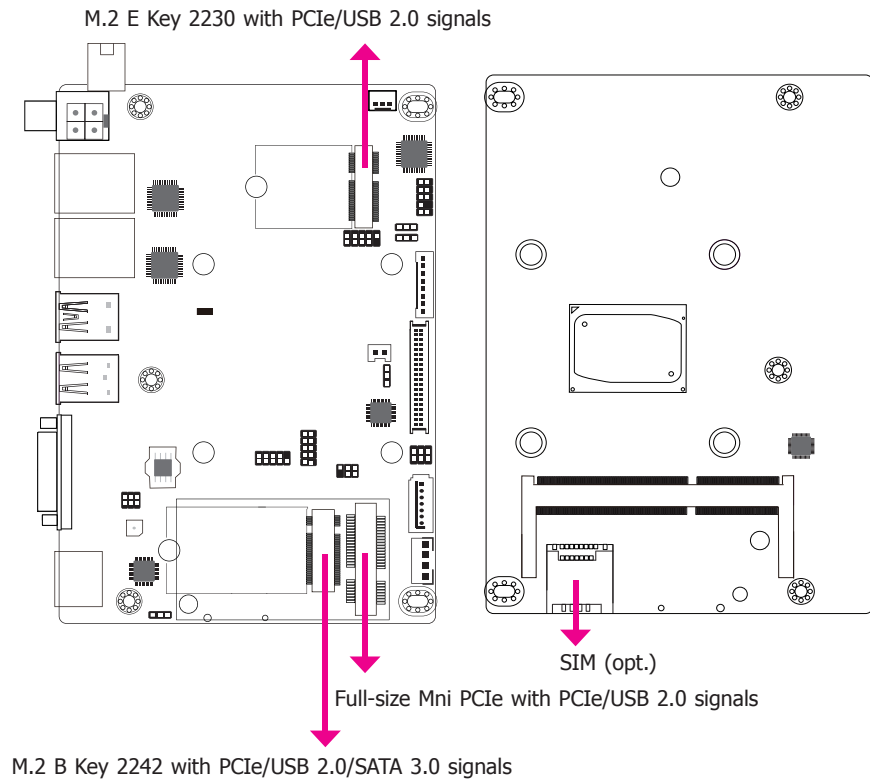

### M.2 Sockets

The M.2 socket is the Next Generation Form Factor (NGFF) which is designed to support multiple modules and make the M.2 more suitable in application for solid-state storage.

### Mini PCI Express Slot

The full-size Mini PCIe socket supports PCIe x1 and USB 2.0 signals and is used to install a Mini PCIe card.

### SIM Slot (opt.)

The SIM slot on the system board is used to insert a SIM card.

## Cooling Fan Connector

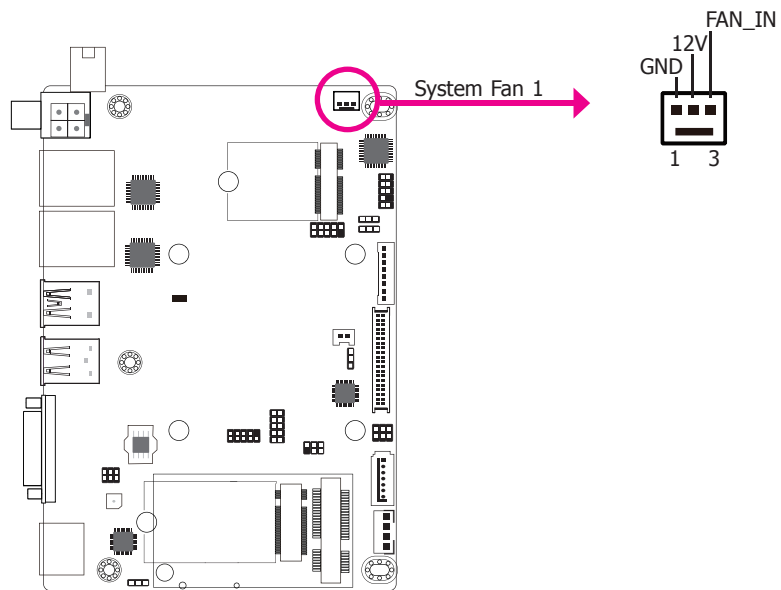

The fan connector is used to connect the cooling fan. The cooling fan will provide adequate airflow throughout the chassis to prevent overheating the CPU and system board components.

### BIOS Setting

The Advanced menu ("Smart Fan Function" of the SIO FINTEK81803 submenu) of the BIOS will display the current speed of the cooling fans. Refer to Chapter 3 for more information.

## Battery

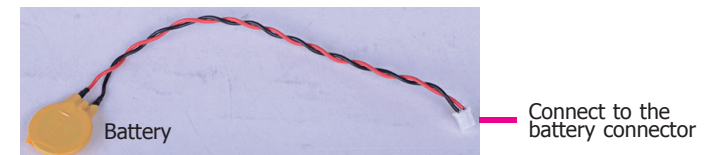
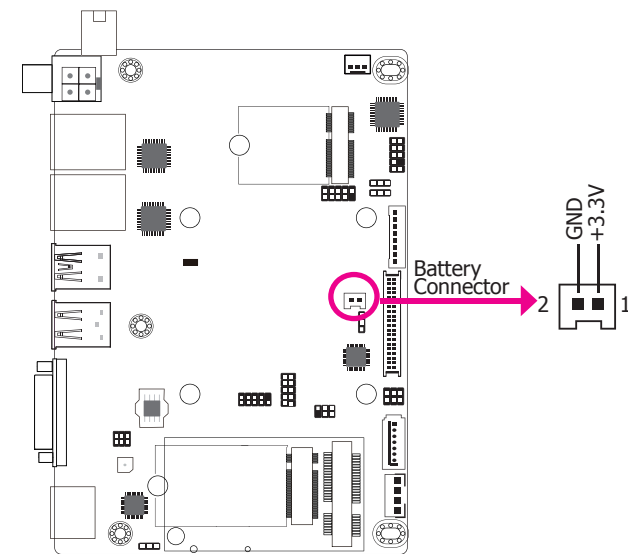

The lithium ion battery powers the real-time clock and CMOS memory. It is an auxiliary source of power when the main power is shut off.

### Safety Measures

- Danger of explosion if battery incorrectly replaced.
- Replace only with the same or equivalent type recommended by the manufacturer.
- Dispose of used batteries according to local ordinance.

## Chapter 3 - BIOS Setup

### Overview

The BIOS is a program that takes care of the basic level of communication between the CPU and peripherals. It contains codes for various advanced features found in this system board. The BIOS allows you to configure the system and save the configuration in a battery-backed CMOS so that the data retains even when the power is off. In general, the information stored in the CMOS RAM of the EEPROM will stay unchanged unless a configuration change has been made such as a hard drive replaced or a device added.

It is possible that the CMOS battery will fail causing CMOS data loss. If this happens, you need to install a new CMOS battery and reconfigure the BIOS settings.



#### Note:

The BIOS is constantly updated to improve the performance of the system board; therefore the BIOS screens in this chapter may not appear the same as the actual one. These screens are for reference purpose only.

### Default Configuration

Most of the configuration settings are either predefined according to the Load Optimal Defaults settings which are stored in the BIOS or are automatically detected and configured without requiring any actions. There are a few settings that you may need to change depending on your system configuration.

### Entering the BIOS Setup Utility

The BIOS Setup Utility can only be operated from the keyboard and all commands are keyboard commands. The commands are available at the right side of each setup screen.

The BIOS Setup Utility does not require an operating system to run. After you power up the system, the BIOS message appears on the screen and the memory count begins. After the memory test, the message "Press DEL to run setup" will appear on the screen. If the message disappears before you respond, restart the system or press the "Reset" button. You may also restart the system by pressing the <Ctrl> <Alt> and <Del> keys simultaneously.

### Legends

Keys	Function
Right and Left arrows	Moves the highlight left or right to select a menu.
Up and Down arrows	Moves the highlight up or down between submenu or fields.
<Esc>	Exit to the BIOS Setup Utility.
<F5>	Scrolls forward through the values or options of the highlighted field.
<F6>	Scrolls backward through the values or options of the highlighted field.
<F1>	Displays general help
<F9>	Optimized defaults
<F10>	Saves and resets the setup program.
<Enter>	Press <Enter> to enter the highlighted submenu.

### Scroll Bar

When a scroll bar appears to the right of the setup screen, it indicates that there are more available fields not shown on the screen. Use the up and down arrow keys to scroll through all the available fields.

### Submenu

When "►" appears on the left of a particular field, it indicates that a submenu which contains additional options are available for that field. To display the submenu, move the highlight to that field and press <Enter>.



## Insyde BIOS Setup Utility

### Main

The Main menu is the first screen that you will see when you enter the BIOS Setup Utility.

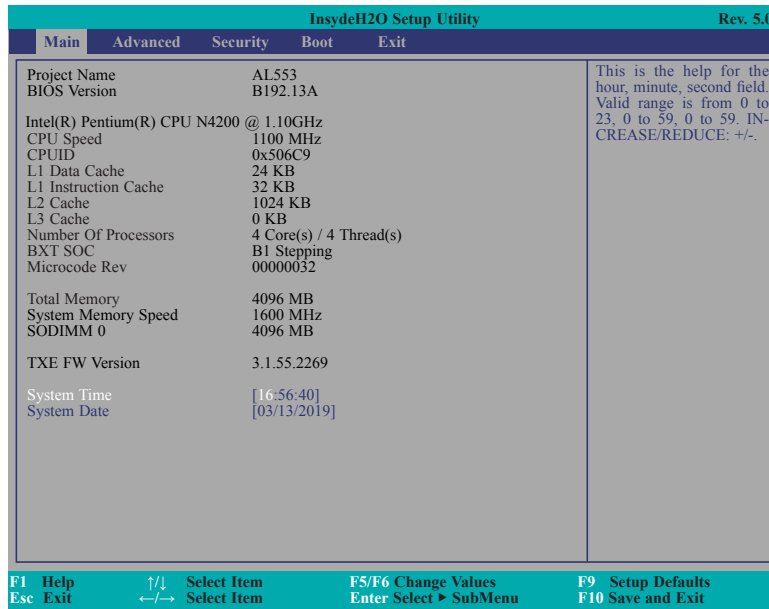

### System Time

The time format is <hour>, <minute>, <second>. The time is based on the 24-hour military-time clock. For example, 1 p.m. is 13:00:00. Hour displays hours from 00 to 23. Minute displays minutes from 00 to 59. Second displays seconds from 00 to 59.

### System Date

The date format is <month>, <date>, <year>. Month displays the month, from 01 to 12. Date displays the date, from 01 to 31. Year displays the year, from 2000 to 2099.

### Advanced

The Advanced menu allows you to configure your system for basic operation. Some entries are defaults required by the system board, while others, if enabled, will improve the performance of your system or let you set some features according to your preference.



#### Important:

Setting incorrect field values may cause the system to malfunction.

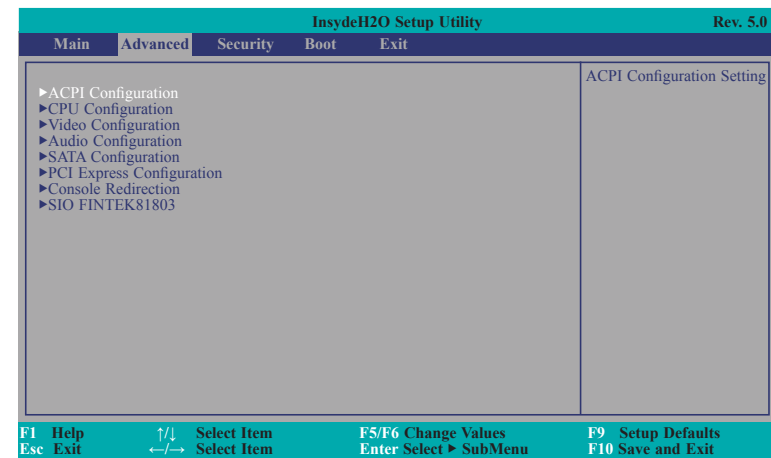

**ACPI Configuration**

This section configures the system ACPI parameters.

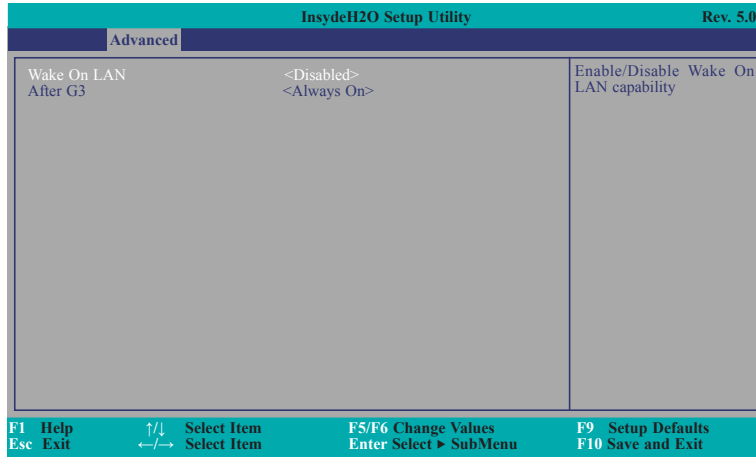

**Wake On LAN**

This field is used to enable or disable the LAN signal to wake up the system.

**After G3**

This field is to specify what state the system should be in when power is re-applied after a power failure (G3, the mechanical-off, state).

**Always On** The system working state.

**Always Off** Off, except for trickle current to devices such as the power button.

**Note:** If "Quiet Boot" of Boot menu is set to enabled, "BGRT Logo" field will appear for configuration. Refer to the Boot menu in this chapter for more information.

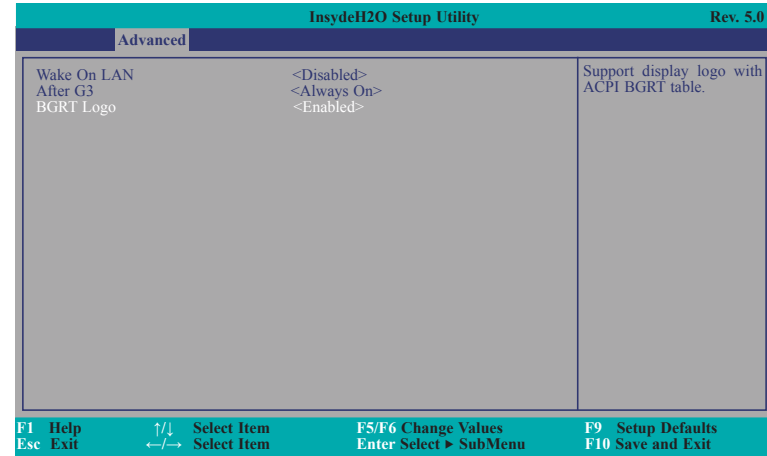

**BGRT Logo**

This field is used to enable or disable to support display logo with ACPI BGRT table.

## CPU Configuration

This section is used to configure the CPU.

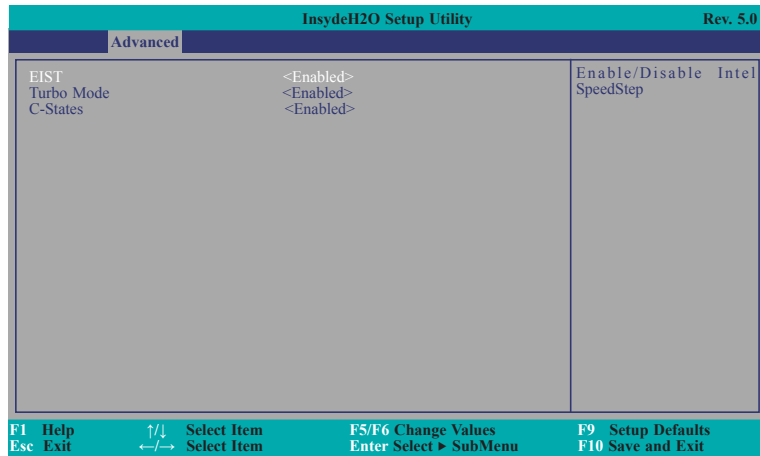

### EIST

This field is used to enable or disable the Enhanced Intel SpeedStep® Technology, which helps optimize the balance between system's power consumption and performance. After it is enabled in the BIOS, you can enable the EIST feature using the operating system's power management.

### Turbo Mode

This field is used to enable or disable processor turbo mode (requires that EIST is enabled too), which allows the processor core to automatically run faster than the base frequency when the processor's power, temperature, and specification are within the limits of TDP.

### C-States

Enable or disable CPU Power Management. It allows CPU to go to C States when it's not 100% utilized.

## Video Configuration

This section configures the video settings.

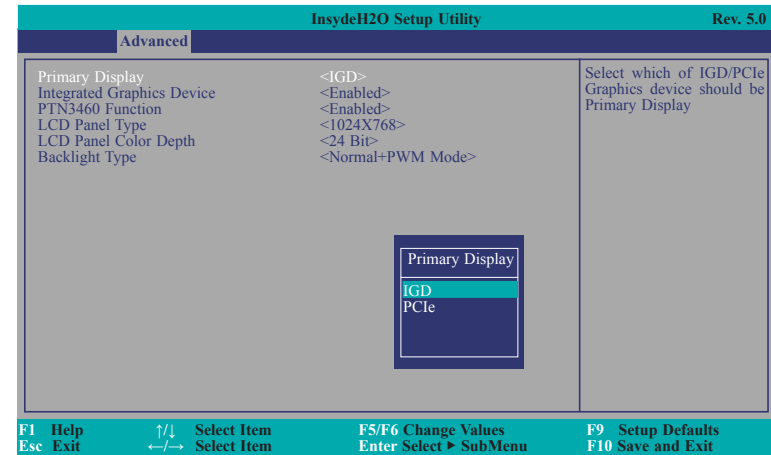

### Primary Display

Select either IGD or PCIe Graphics device to be the primary display.

### Integrated Graphics Device

Keep IGD enabled or disabled based on the setup options.

### PTN3460 Function

Enable or disable PTN3460 LCD features.

### LCD Panel Type

Please check the specifications of your LCD monitor. Select the type of LCD panel connected to the system's LCD connector: 800X480, 800X600, 1024X768, 1366X768, 1280X1024, 1920X1080 or 1920X1200.

### LCD Panel Color Depth

Select the LCD panel color depth: 18 Bit, 24 Bit, 36 Bit or 48 Bit.

### Backlight Type

Select the backlight type setting: normal+PWM mode, normal+DC mode, invert+PWM mode or invert+DC mode.

## Audio Configuration

This section is used to configure the audio settings.

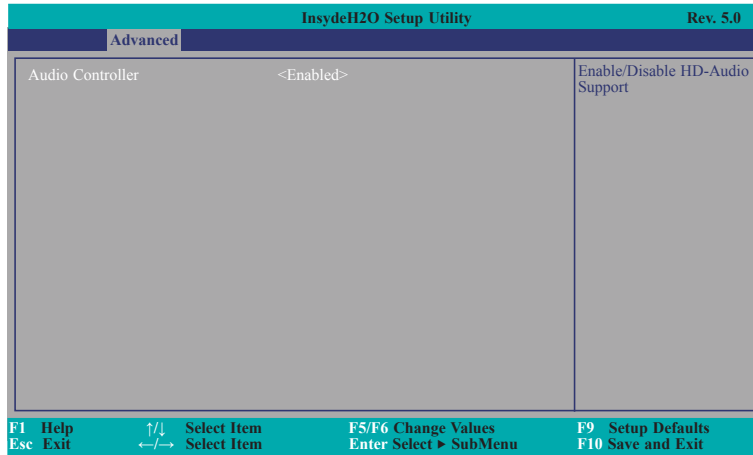

### Audio Controller

Control the support of the high-definition audio device.

#### Disabled

HD Audio will be disabled.

#### Enabled

HD Audio will be enabled.

## SATA Configuration

This section configures the SATA controller.

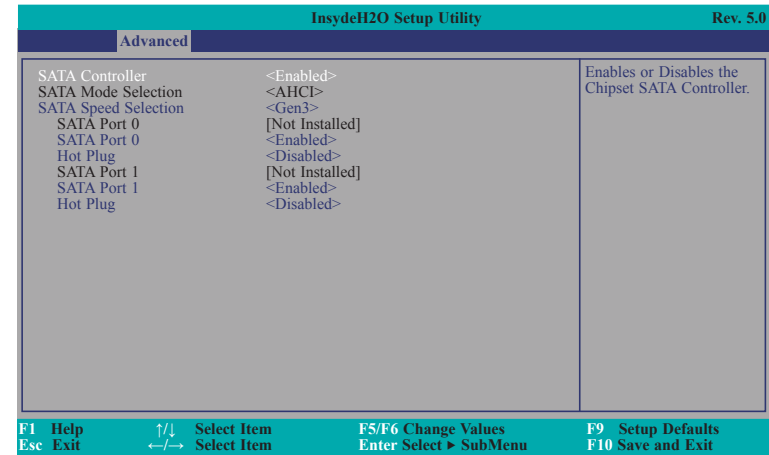

### SATA Controller

This field is used to enable or disable the Serial ATA controller.

### SATA Mode Selection

The mode selection determines how the SATA controller(s) operates.

#### AHCI

This option allows the Serial ATA devices to use AHCI (Advanced Host Controller Interface).

### SATA Speed Selection

Select Serial ATA controller(s) speed from Gen1 (1.5 Gbit/s), Gen2 (3.0 Gbit/s) or Gen 3 (6.0 Gbit/s).

### Serial ATA Port 0/1 and Hot Plug

These fields are used to enable or disable the serial ATA ports and their hot plug function.

## PCI Express Configuration

This section configures settings relevant to PCI Express root ports.

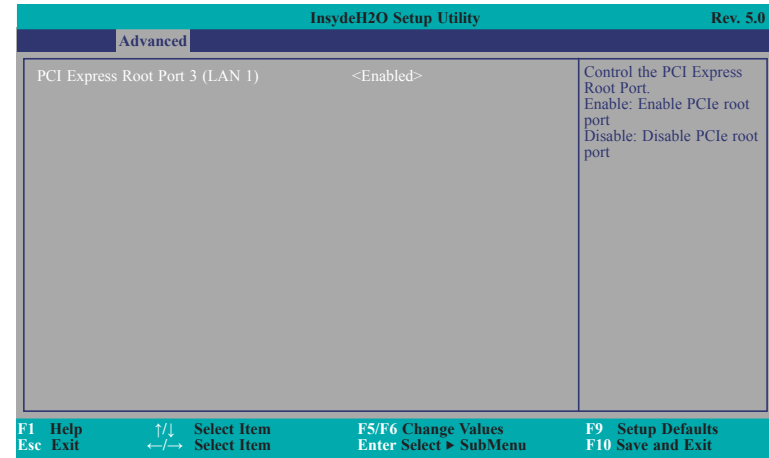
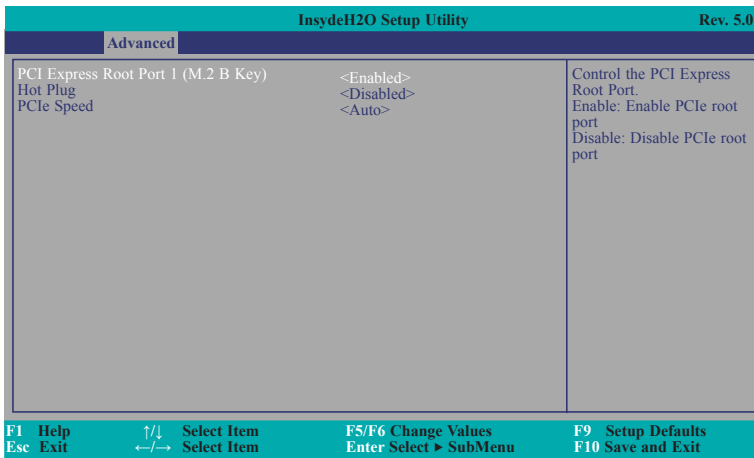
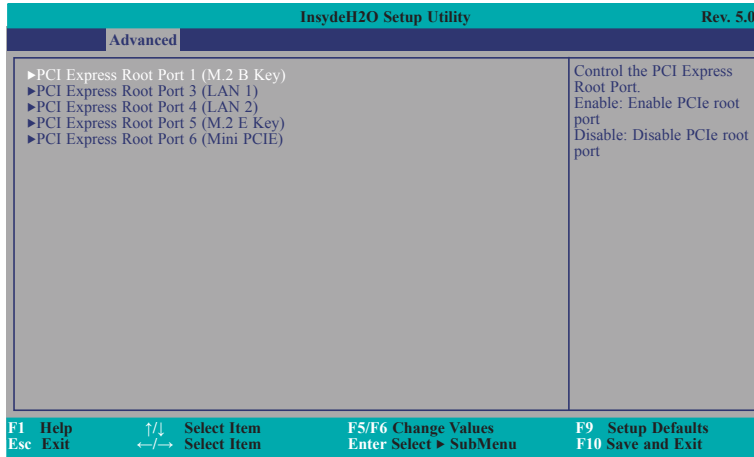

### PCI Express Root Port 1/3/4/5/6

This field is used to enable or disable the PCI Express Root Port.

### Hot Plug

This field is used to enable or disable the PCI Express Hot Plug.

### PCIe Speed

Select the speed of the PCI Express Root Port: Auto, Gen1 or Gen2.

## Console Redirection

This section configures settings relevant to console redirection.

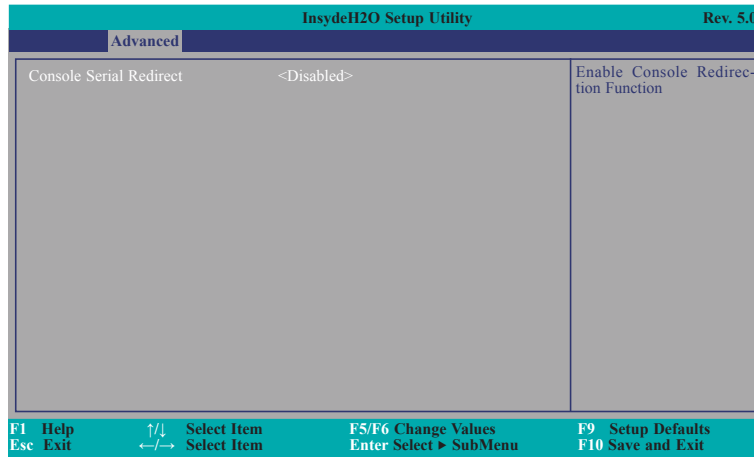

### Console Serial Redirect

This field is used to enable or disable the console serial redirection function.

When Console Serial Redirect is set to enabled, the screen will appear like below:

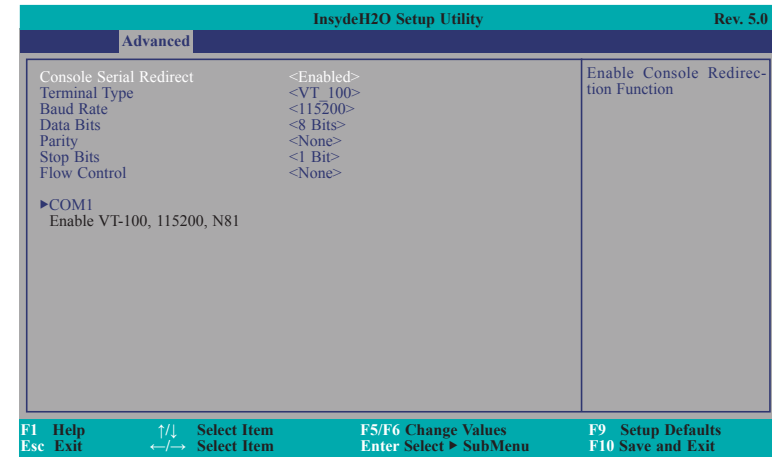

### Terminal Type

Select terminal type: VT\_100, VT\_100+, VT\_UTF8 or PC\_ANSI.

### Baud Rate

Select baud rate: 115200, 57600, 38400, 19200 or 9600.

### Data Bits

Select data bits: 7 Bits or 8 Bits.

### Parity

Select parity bits: None, Even or Odd.

### Stop Bits

Select stop bits: 1 Bit or 2 Bits.

### Flow Control

Select flow control type: None, RTS/CTS or XON/XOFF.

## COM1

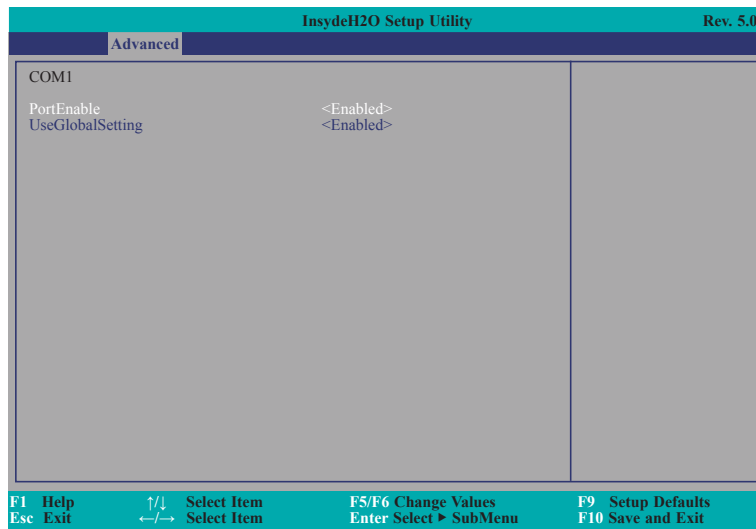

When UseGlobalSetting is set to disabled, the screen will appear like below:

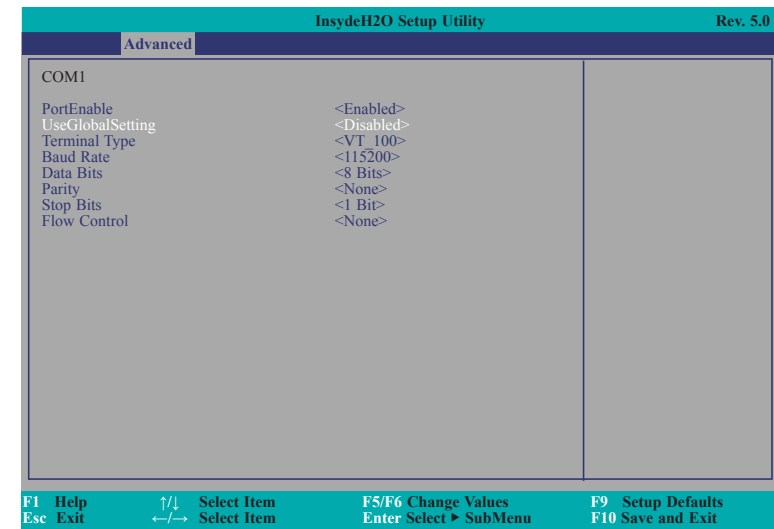

### PortEnable

This field is used to enable or disable the COM port to redirect the console.

### UseGlobalSetting

This field is to enable or disable to use global setting. When enabled the global setting, setting of the COM port will be the same as those in Console Redirection section. When disabled the global setting, setting of the COM port can be configured independently in this section.

**SIO FINTEK81803**

This section configures the system super I/O chip parameters.

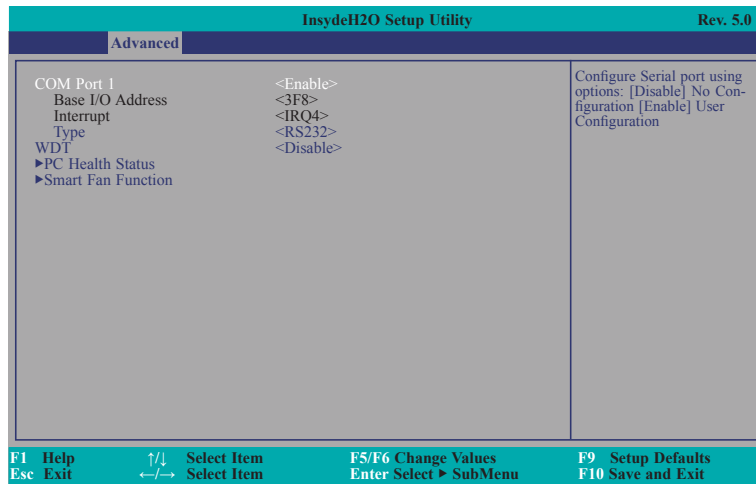
**COM Port 1**

Configure the settings to use the serial port.

**Disable** No configuration

**Enable** User configuration

**Type**

Choose RS232/RS422/RS485 (Peer-to-Peer) for COM type.

**WDT**

Enable or disable the watchdog function. A counter will appear if you select to enable WDT. Input any value between 1 to 255 seconds.

**PC Health Status**

This section displays the PC health status.

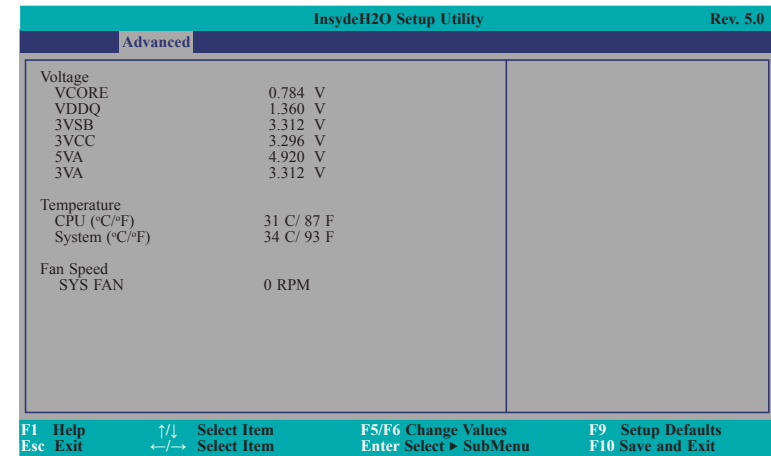



## Smart Fan Function

This section configures the Smart Fan Function.

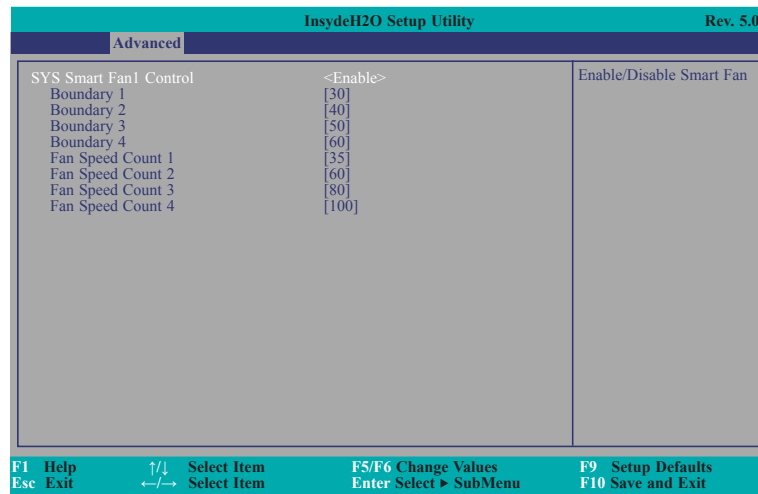

### SYS Smart Fan1 Control

Enable or disable the system smart fan. If disabled, Fix Fan Speed Count field ranged from 1 to 100% (full speed) will appear.

### Boundary 1 to Boundary 4

Set the boundary temperatures that determine the operation of the fan with different fan speeds accordingly. For example, when the system or the CPU temperature reaches boundary 1 temperature, the system or CPU fan should be turned on and operate at the designated speed. The range is from 0-127°C.

### Fan Speed Count 1 to Fan Speed Count 4

Set the fan speed. The range is from 1 to 100% (full speed). The fan will operate according to the specified boundary temperatures above.

## Security

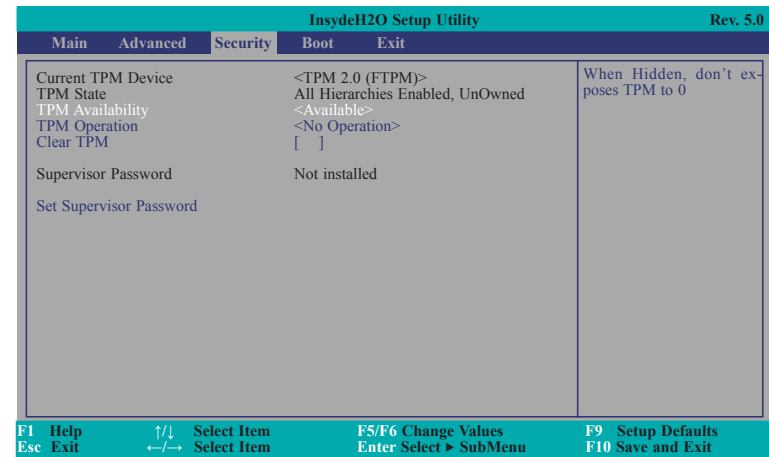

### TPM Availability

Show or hide the TPM availability and its configurations.

### TPM Operation

Enable or disable the TPM function. It displays the following options:

**No Operation** No changes to current state.

**Enable** Enable and activate TPM.

**Disable** Disable and activate TPM.

### Clear TPM

Remove all TPM context associated with a specific owner.

### Set Supervisor Password

Set the supervisor's password and the length of the password must be greater than one character.

## Boot

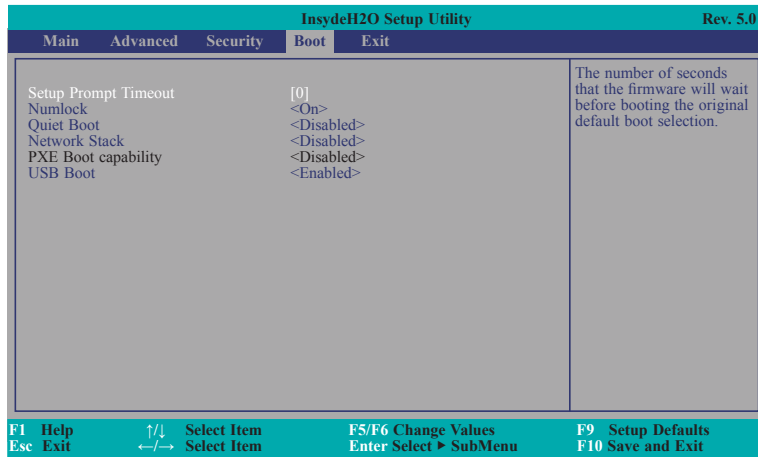

**Note:**  
AL553 only supports UEFI boot, no Legacy boot.

### Setup Prompt Timeout

Setup the number of seconds that the firmware will wait before booting the original default boot selection.

### Numlock

Select the power-on state for numlock.

### Quiet Boot

Enable or disable booting in text mode.

### Network Stack

This field is used to enable or disable network stack.

### PXE Boot capability

**Disabled** Support Network Stack

**UEFI** IPv4/IPv6

### USB Boot

Enable or disable booting to USB boot devices.

## Exit

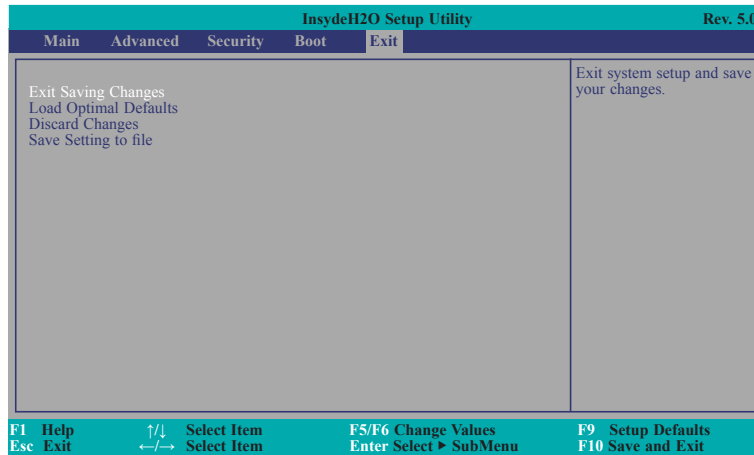

### Exit Saving Changes

Select Yes and press <Enter> to exit the system setup and save your changes.

### Load Optimal Defaults

Select YES and press <Enter> to load optimal defaults.

### Discard Changes

Select YES and press <Enter> to exit the system setup without saving your changes.

### Save Setting to file

Select this option to save BIOS configuration settings to a USB flash device.

### Restore Setting from file

This field will appear only when a USB flash device is detected. Select this field to restore setting from the USB flash device.

## Updating the BIOS

To update the BIOS, you will need the new BIOS file and a flash utility. Please contact technical support or your sales representative for the files and specific instructions about how to update BIOS with the flash utility. For updating Insyde BIOS in UEFI mode, you may refer to the how-to-video at <https://www.dfi.com/Knowledge/Video/31>.

**Notice: BIOS SPI ROM**

1. The Intel® Trusted Execution Engine has already been integrated into this system board. Due to the safety concerns, the BIOS (SPI ROM) chip cannot be removed from this system board and used on another system board of the same model.
2. The BIOS (SPI ROM) on this system board must be the original equipment from the factory and cannot be used to replace one which has been utilized on other system boards.
3. If you do not follow the methods above, the Intel® Trusted Execution Engine will not be updated and will cease to be effective.

**Note:**

- a. You can take advantage of flash tools to update the default configuration of the BIOS (SPI ROM) to the latest version anytime.
- b. When the BIOS IC needs to be replaced, you have to populate it properly onto the system board after the EEPROM programmer has been burned and follow the technical person's instructions to confirm that the MAC address should be burned or not.

## Chapter 4 - Supported Software

Please download drivers, utilities and software applications required to enhance the performance of AL553 at <https://www.dfi.com/product/index/1409>.

### Intel Chipset Software Installation Utility

The Intel Chipset Software Installation Utility is used for updating Windows® INF files so that the Intel chipset can be recognized and configured properly in the system.

To install the utility, download "AL553 Chipset Driver" zip file at our website.

1. Setup is ready to install the utility. Click "Next".

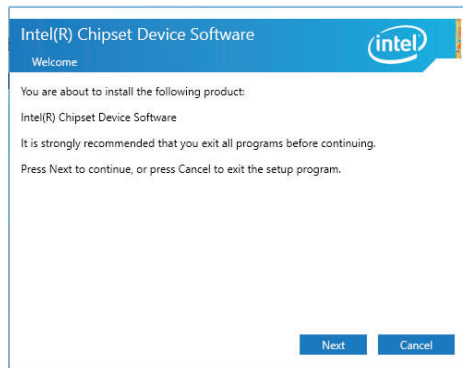

2. Read the license agreement then click "Accept".

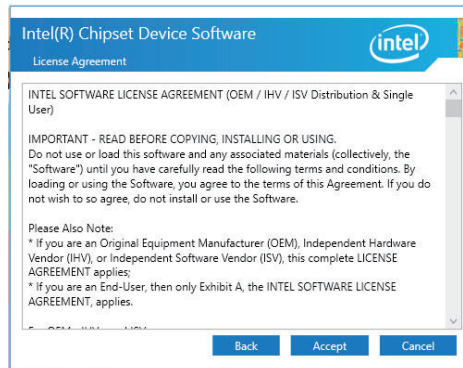

3. Go through the readme document for more installation tips then click "Install".

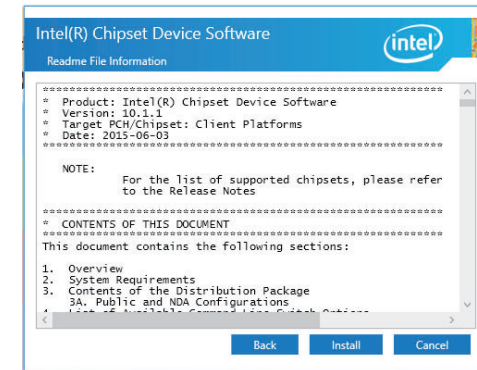

4. The step displays the installing status in the progress.

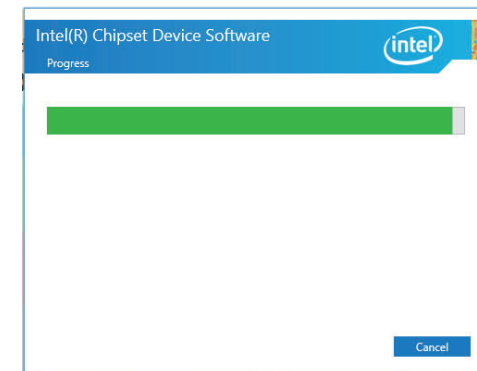

5. After completing installation, click "Restart Now" to exit setup.

Restarting the system will allow the new software installation to take effect.



## Intel Graphics Drivers

To install the driver, download "AL553 Graphics Driver" zip file at our website.

1. Setup is now ready to install the graphics driver. Click "Next".

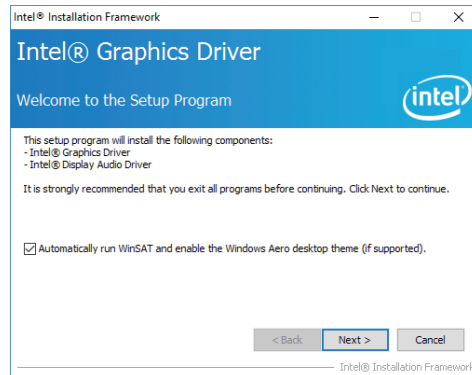

By default, the "Automatically run WinSAT and enable the Windows Aero desktop theme" is enabled. With this enabled, after installing the graphics driver and the system rebooted, the screen will turn blank for 1 to 2 minutes (while WinSAT is running) before the Windows 10 desktop appears. The "blank screen" period is the time Windows is testing the graphics performance.

We recommend that you skip this process by disabling this function then click "Next".

2. Read the license agreement then click "Yes".

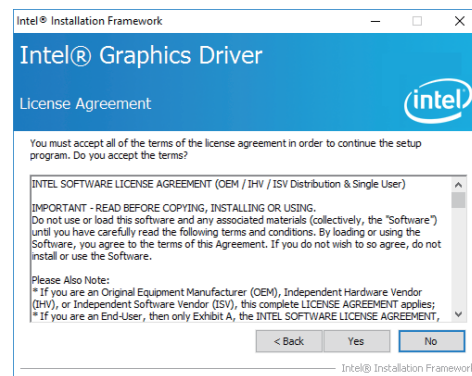

3. Go through the readme document for system requirements and installation tips then click "Next".

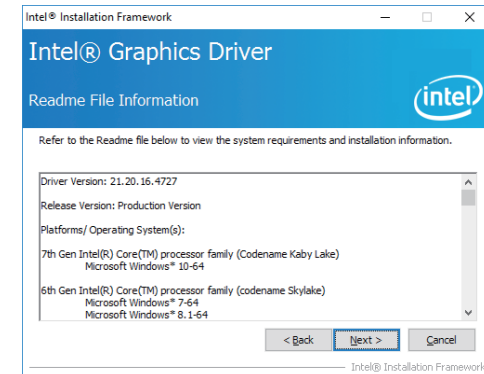

4. Setup is now installing the driver. Click "Next" to continue.

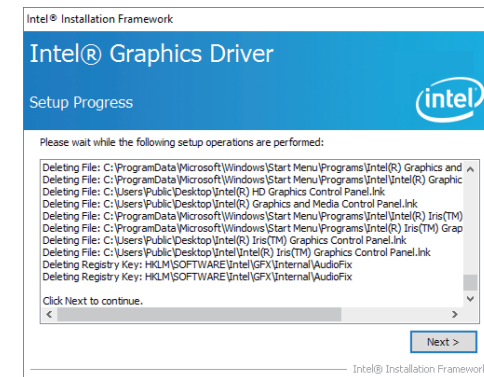

5. Click "Yes, I want to restart this computer now" then click "Finish".

Restarting the system will allow the new software installation to take effect.

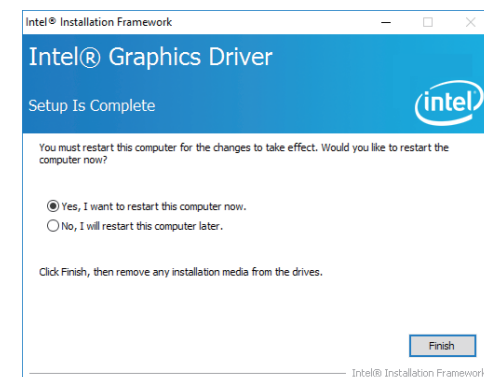

## Audio Drivers

To install the driver, download "AL553 Audio Driver" zip file at our website.

1. Setup is ready to install the driver. Click "Next".

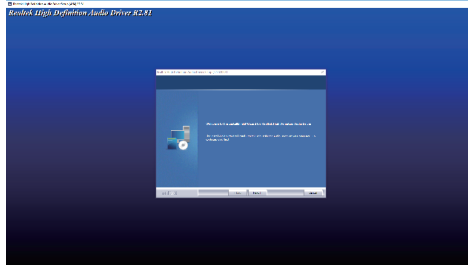

2. Click "Yes, I want to restart my computer now" then click "Finish".

Restarting the system will allow the new software installation to take effect.

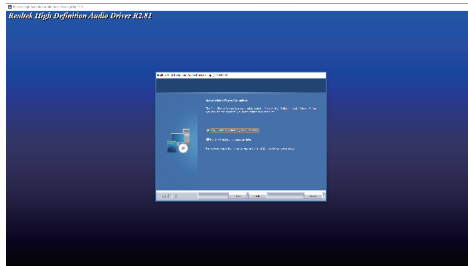

## Intel LAN Drivers

To install the driver, download "AL553 LAN Driver" zip file at our website.

1. Setup is ready to install the driver. Click "Next".

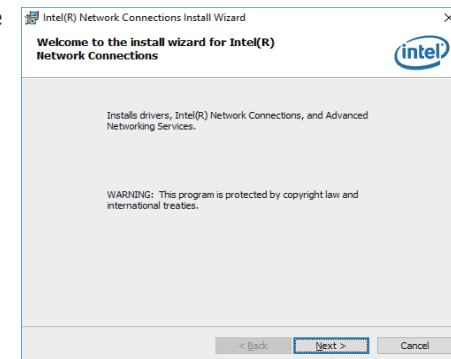

2. Click "I accept the terms in the license agreement" then click "Next".

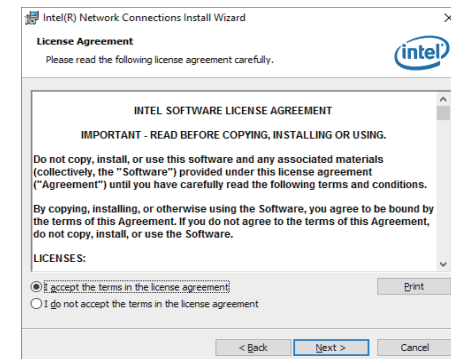

3. Select the program features you want installed then click "Next".

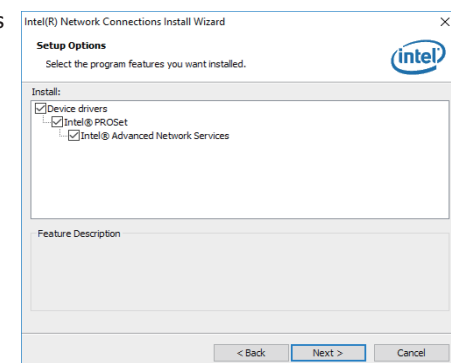

4. Click "Install" to begin the installation.

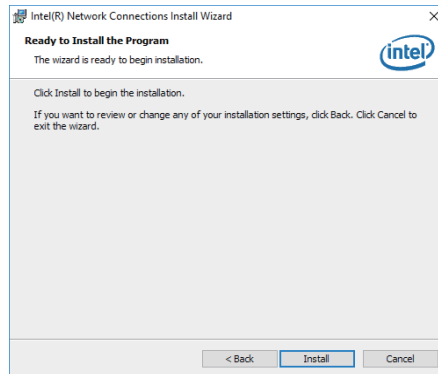

5. The step displays the installing status in the progress.

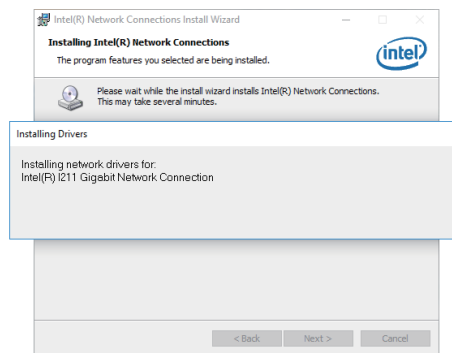

6. After completing installation, click "Finish".

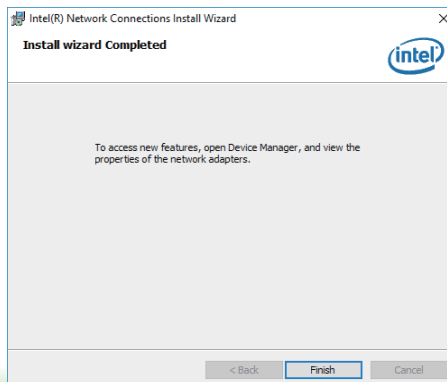

## Intel Trusted Execution Engine Driver

To install the driver, download "AL553 TXE Driver" zip file at our website.

1. Tick "I accept the terms in the License Agreement" and then click "Next."

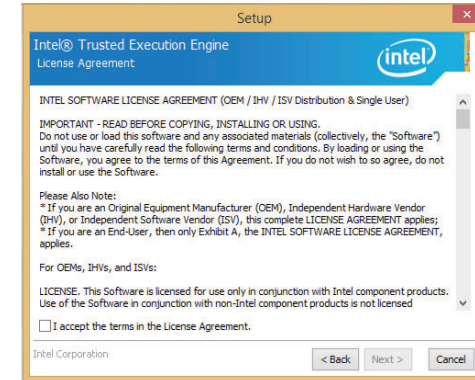

2. The step shows the components which will be installed. Then, Click Next.

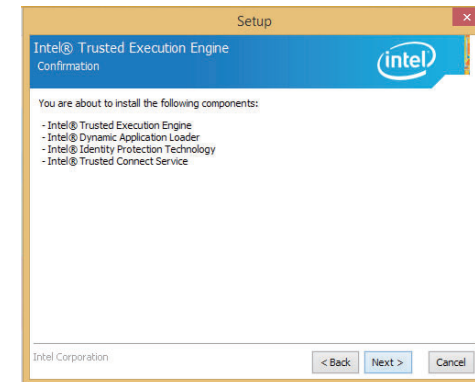



3. The step displays the installing status in the progress.

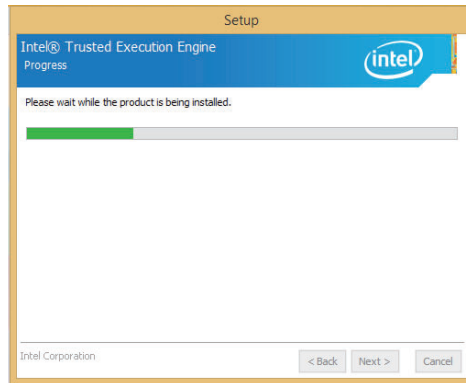

4. Click "Finish" when the installation is complete.

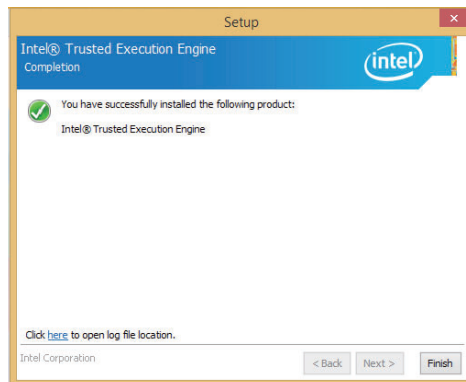

## SIO Driver

To install the driver, download "AL553 SIO Driver" zip file at our website.

1. Setup is ready to install the driver.  
Click "Next".

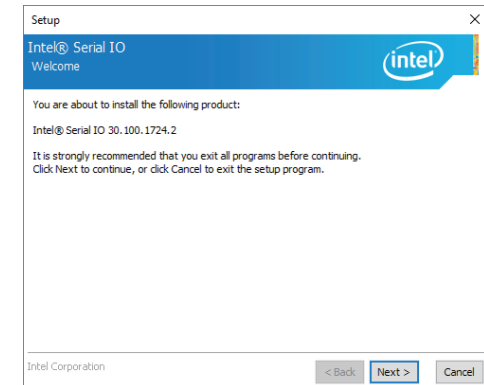

2. Read the license agreement carefully.  
Tick "I accept the terms in the License Agreement" then click "Next".



3. Go through the readme document for system requirements and installation tips then click "Next".

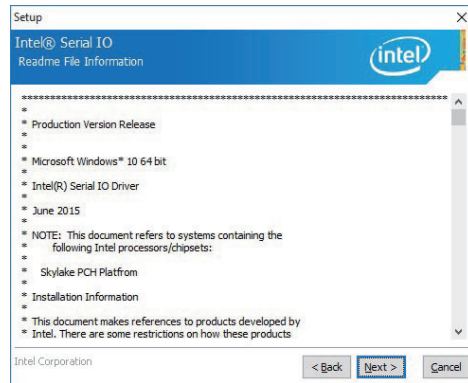

4. Setup is ready to install the driver. Click "Next".

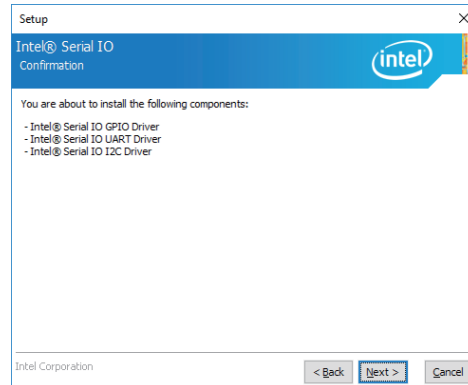

5. Setup is now installing the driver.

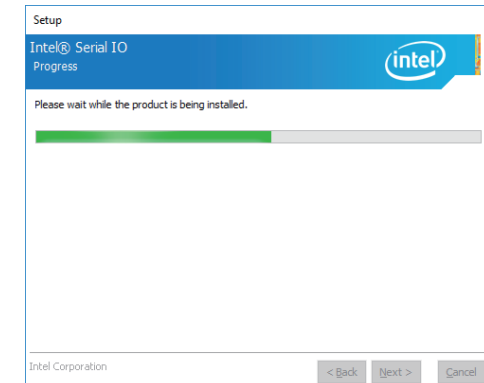

6. Click "Yes, I want to restart this computer now" then click "Finish".

Restarting the system will allow the new software installation to take effect.

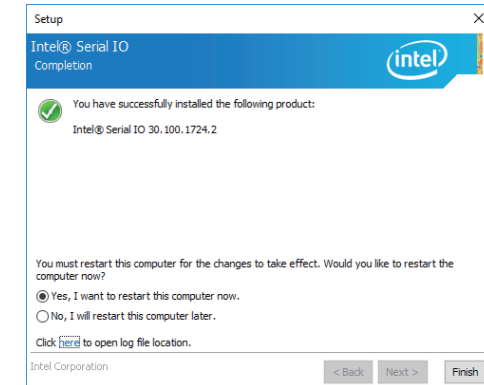

## Appendix A - Troubleshooting Checklist

### Troubleshooting Checklist

This chapter of the manual is designed to help you with problems that you may encounter with your personal computer. To efficiently troubleshoot your system, treat each problem individually. This is to ensure an accurate diagnosis of the problem in case a problem has multiple causes.

Some of the most common things to check when you encounter problems while using your system are listed below.

1. The power switch of each peripheral device is turned on.
2. All cables and power cords are tightly connected.
3. The electrical outlet to which your peripheral devices connected is working. Test the outlet by plugging in a lamp or other electrical device.
4. The monitor is turned on.
5. The display's brightness and contrast controls are adjusted properly.
6. All add-in boards in the expansion slots are seated securely.
7. Any add-in board you have installed is designed for your system and is set up correctly.

### Monitor/Display

#### If the display screen remains dark after the system is turned on:

1. Make sure that the monitor's power switch is on.
2. Check that one end of the monitor's power cord is properly attached to the monitor and the other end is plugged into a working AC outlet. If necessary, try another outlet.
3. Check that the video input cable is properly attached to the monitor and the system's display adapter.
4. Adjust the brightness of the display by turning the monitor's brightness control knob.

#### The picture seems to be constantly moving.

1. The monitor has lost its vertical sync. Adjust the monitor's vertical sync.
2. Move away any objects, such as another monitor or fan, that may be creating a magnetic field around the display.
3. Make sure your video card's output frequencies are supported by this monitor.

#### The screen seems to be constantly wavering.

1. If the monitor is close to another monitor, the adjacent monitor may need to be turned off. Fluorescent lights adjacent to the monitor may also cause screen wavering.

### Power Supply

#### When the computer is turned on, nothing happens.

1. Check that one end of the AC power cord is plugged into a live outlet and the other end properly plugged into the back of the system.
2. Make sure that the voltage selection switch on the back panel is set for the correct type of voltage you are using.
3. The power cord may have a "short" or "open". Inspect the cord and install a new one if necessary.

## Hard Drive

### Hard disk failure.

1. Make sure the correct drive type for the hard disk drive has been entered in the BIOS.
2. If the system is configured with two hard drives, make sure the bootable (first) hard drive is configured as Master and the second hard drive is configured as Slave. The master hard drive must have an active/bootable partition.

### Excessively long formatting period.

If your hard drive takes an excessively long period of time to format, it is likely a cable connection problem. However, if your hard drive has a large capacity, it will take a longer time to format.

## Serial Port

### The serial device (modem, printer) doesn't output anything or is outputting garbled characters.

1. Make sure that the serial device's power is turned on and that the device is on-line.
2. Verify that the device is plugged into the correct serial port on the rear of the computer.
3. Verify that the attached serial device works by attaching it to a serial port that is working and configured correctly. If the serial device does not work, either the cable or the serial device has a problem. If the serial device works, the problem may be due to the onboard I/O or the address setting.
4. Make sure the COM settings and I/O address are configured correctly.

## Keyboard

### Nothing happens when a key on the keyboard was pressed.

1. Make sure the keyboard is properly connected.
2. Make sure there are no objects resting on the keyboard and that no keys are pressed during the booting process.

## System Board

1. Make sure the add-in card is seated securely in the expansion slot. If the add-in card is loose, power off the system, re-install the card and power up the system.
2. Check the jumper settings to ensure that the jumpers are properly set.
3. Verify that all memory modules are seated securely into the memory sockets.
4. Make sure the memory modules are in the correct locations.
5. If the board fails to function, place the board on a flat surface and seat all socketed components. Gently press each component into the socket.
6. If you made changes to the BIOS settings, re-enter setup and load the BIOS defaults.