

BT9A3

COM Express Mini Module

User's Manual

Copyright

This publication contains information that is protected by copyright. No part of it may be reproduced in any form or by any means or used to make any transformation/adaptation without the prior written permission from the copyright holders.

This publication is provided for informational purposes only. The manufacturer makes no representations or warranties with respect to the contents or use of this manual and specifically disclaims any express or implied warranties of merchantability or fitness for any particular purpose. The user will assume the entire risk of the use or the results of the use of this document. Further, the manufacturer reserves the right to revise this publication and make changes to its contents at any time, without obligation to notify any person or entity of such revisions or changes.

Changes after the publication's first release will be based on the product's revision. The website will always provide the most updated information.

© 2017. All Rights Reserved.

Trademarks

Product names or trademarks appearing in this manual are for identification purpose only and are the properties of the respective owners.

COM Express Specification Reference

PICMG® COM Express Module™ Base Specification.

<http://www.picmg.org/>

FCC and DOC Statement on Class B

This equipment has been tested and found to comply with the limits for a Class B digital device, pursuant to Part 15 of the FCC rules. These limits are designed to provide reasonable protection against harmful interference when the equipment is operated in a residential installation. This equipment generates, uses and can radiate radio frequency energy and, if not installed and used in accordance with the instruction manual, may cause harmful interference to radio communications. However, there is no guarantee that interference will not occur in a particular installation. If this equipment does cause harmful interference to radio or television reception, which can be determined by turning the equipment off and on, the user is encouraged to try to correct the interference by one or more of the following measures:

- Reorient or relocate the receiving antenna.
- Increase the separation between the equipment and the receiver.
- Connect the equipment into an outlet on a circuit different from that to which the receiver is connected.
- Consult the dealer or an experienced radio TV technician for help.

Notice:

1. The changes or modifications not expressly approved by the party responsible for compliance could void the user's authority to operate the equipment.
2. Shielded interface cables must be used in order to comply with the emission limits.

Table of Contents

Copyright.....	2	Chapter 4 - BIOS Setup.....	26
Trademarks.....	2	Overview	26
FCC and DOC Statement on Class B.....	2	AMI BIOS Setup Utility.....	27
About this Manual	4	Main	27
Warranty.....	4	Advanced.....	27
Static Electricity Precautions.....	4	Chipset.....	34
Safety Measures	4	Security	38
About the Package.....	5	Boot	39
Chapter 1 - Introduction.....	6	Save & Exit.....	39
Specifications	6	Updating the BIOS.....	40
Features	7	Notice: BIOS SPI ROM	40
Chapter 2 - Concept.....	8	Chapter 5 - Supported Software.....	41
COM Express Module Standards.....	8	Chapter 6 - GPIO Programming Guide.....	52
Specification Comparison Table	9	Appendix A - Watchdog Sample Code.....	53
Chapter 3 - Hardware Installation.....	10	Appendix B - System Error Message.....	54
Board Layout.....	10	Appendix C - Troubleshooting	56
Block Diagram.....	10		
Mechanical Diagram	11		
System Memory.....	12		
Connectors.....	13		
CPU Fan Connector.....	13		
COM Express Connector.....	13		
COM Express Connector Signal Discription	15		
Cooling Option.....	21		
Installing BT9A3 onto a Carrier Board.....	21		
Installing the COM Express Debug Card.....	23		

About this Manual

This manual can be downloaded from the website, or acquired as an electronic file included in the optional CD/DVD. The manual is subject to change and update without notice, and may be based on editions that do not resemble your actual products. Please visit our website or contact our sales representatives for the latest editions.

Warranty

1. Warranty does not cover damages or failures that arised from misuse of the product, inability to use the product, unauthorized replacement or alteration of components and product specifications.
2. The warranty is void if the product has been subjected to physical abuse, improper installation, modification, accidents or unauthorized repair of the product.
3. Unless otherwise instructed in this user's manual, the user may not, under any circumstances, attempt to perform service, adjustments or repairs on the product, whether in or out of warranty. It must be returned to the purchase point, factory or authorized service agency for all such work.
4. We will not be liable for any indirect, special, incidental or consequential damages to the product that has been modified or altered.

Static Electricity Precautions

It is quite easy to inadvertently damage your PC, system board, components or devices even before installing them in your system unit. Static electrical discharge can damage computer components without causing any signs of physical damage. You must take extra care in handling them to ensure against electrostatic build-up.

1. To prevent electrostatic build-up, leave the system board in its anti-static bag until you are ready to install it.
2. Wear an antistatic wrist strap.
3. Do all preparation work on a static-free surface.
4. Hold the device only by its edges. Be careful not to touch any of the components, contacts or connections.
5. Avoid touching the pins or contacts on all modules and connectors. Hold modules or connectors by their ends.



Important:

Electrostatic discharge (ESD) can damage your processor, disk drive and other components. Perform the upgrade instruction procedures described at an ESD workstation only. If such a station is not available, you can provide some ESD protection by wearing an antistatic wrist strap and attaching it to a metal part of the system chassis. If a wrist strap is unavailable, establish and maintain contact with the system chassis throughout any procedures requiring ESD protection.

Safety Measures

To avoid damage to the system:

- Use the correct AC input voltage range.

To reduce the risk of electric shock:

- Unplug the power cord before removing the system chassis cover for installation or servicing. After installation or servicing, cover the system chassis before plugging the power cord.

About the Package

The package contains the following items. If any of these items are missing or damaged, please contact your dealer or sales representative for assistance.

- One BT9A3 board
- One QR (Quick Reference)
- One Heat sink

Optional Items

- COM100-B carrier board kit
- Heat sink with fan
- Heat spreader

The board and accessories in the package may not come similar to the information listed above. This may differ in accordance with the sales region or models in which it was sold. For more information about the standard package in your region, please contact your dealer or sales representative.

Before Using the System Board

Before using the system board, prepare basic system components.

If you are installing the system board in a new system, you will need at least the following internal components.

- Storage devices such as hard disk drive, CD-ROM, etc.

You will also need external system peripherals you intend to use which will normally include at least a keyboard, a mouse and a video display monitor.

Chapter 1 - Introduction

Specifications

Processor	<ul style="list-style-type: none"> Intel® Atom™/Intel® Celeron® processors - E45: Intel® Atom™ E3845, Quad Core, 2M Cache, 1.91GHz, 10W - E27: Intel® Atom™ E3827, Dual Core, 1M Cache, 1.75GHz, 8W - E15: Intel® Atom™ E3815, Single Core, 0.5M Cache, 1.46GHz, 5W - J00: Intel® Celeron® J1900, Quad Core, 2M Cache, 2GHz (2.41GHz), 10W - N30: Intel® Celeron® N2930, Quad Core, 2M Cache, 1.83GHz (2.16GHz), 7.5W BGA 1170 packaging technology 22nm process technology
System Memory	<ul style="list-style-type: none"> 2GB/4GB DDR3L ECC memory down Supports DDR3L 1333MHz (-E45/-E27/-J00/-N30) Supports DDR3L 1066MHz (-E15) Supports single channel memory interface
Graphics	<ul style="list-style-type: none"> Intel® HD Graphics Supports LVDS and DDI interfaces LVDS: NXP PTN3460, 18/24-bit, single channel, resolution up to 1366x768 @60Hz Digital Display Interfaces: HDMI, DVI and DP HDMI, DVI: resolution up to 1920x1080 @60Hz DP: resolution up to 2560x1600 @60Hz Supports hardware acceleration for DirectX 11, OCL 1.2, OGL 4.0, H.264, MPEG2, MVC, VC-1, WMV9 and VP8 (supported version dependent on OS)
Audio	<ul style="list-style-type: none"> Supports High Definition Audio interface
LAN	<ul style="list-style-type: none"> Intel® I210 Gigabit Ethernet Controller Integrated 10/100/1000 transceiver Fully compliant with IEEE 802.3, IEEE 802.3u, IEEE 802.3ab
Serial ATA	<ul style="list-style-type: none"> Supports 2 Serial ATA interfaces SATA 2.0 with data transfer rate up to 3Gb/s Integrated Advanced Host Controller Interface (AHCI) controller
Expansion Interfaces	<ul style="list-style-type: none"> Supports 1 USB 3.0 port Supports 8 USB 2.0 ports <ul style="list-style-type: none"> - 4 integrated USB 2.0 ports - 1 USB HSIC for 4 USB 2.0 ports Supports 3 PCIe x1 (default); or 1 PCIe x4* (BOM option) Supports LPC interface Supports I²C interface Supports SMBus interface Supports 2 serial interfaces (TX/RX) Supports 8-bit Digital I/O

eMMC* (optional)	<ul style="list-style-type: none"> Supports 4GB, 8GB, 16GB and 32GB eMMC onboard
Watchdog Timer	<ul style="list-style-type: none"> Watchdog timeout programmable via software from 1 to 255 seconds
Damage Free Intelligence	<ul style="list-style-type: none"> Monitors CPU/system temperature and overheat alarm Monitors Vcore/Vgfx/VDDR/3V3 voltages and failure alarm Monitors CPU/system fan speed and failure alarm Watchdog timer function
BIOS	<ul style="list-style-type: none"> AMI BIOS - 64Mbit SPI BIOS
Power Consumption	<ul style="list-style-type: none"> TBD
OS Support	<ul style="list-style-type: none"> Windows 7 Ultimate x86 & SP1 (32-bit) Windows 7 Ultimate x64 & SP1 (64-bit) Windows 8 Enterprise x86 (32-bit) Windows 8 Enterprise x64 (64-bit) Windows 8.1 Enterprise x86 (32-bit) Windows 8.1 Enterprise x64 (64-bit) Windows 8.1 Embedded Pro x86 (32-bit) Windows 8.1 Embedded Pro x64 (64-bit)
Temperature	<ul style="list-style-type: none"> Operating <ul style="list-style-type: none"> : 0°C to 60°C - Atom, Celeron (Fanless) : -20°C to 70°C - Atom (Fanless with air flow) : -40°C to 85°C - Atom (Fanless with air flow) Storage: -40°C to 85°C
Humidity	<ul style="list-style-type: none"> 5% to 90%
Power Input	<ul style="list-style-type: none"> 4.75V~20V, 5VSB, VCC_RTC (ATX mode) 4.75V~20V, VCC_RTC (AT mode)
PCB	<ul style="list-style-type: none"> Dimensions <ul style="list-style-type: none"> - COM Express® Mini - 84mm (3.30") x 55mm (2.16") Compliance <ul style="list-style-type: none"> - PICMG COM Express® R2.1, Type 10

Note:

*Optional and is not supported in standard model. Please contact your sales representative for more information.

Features

• Watchdog Timer

The Watchdog Timer function allows your application to regularly “clear” the system at the set time interval. If the system hangs or fails to function, it will reset at the set time interval so that your system will continue to operate.

• DDR3L

DDR3L is a higher performance DDR3 SDRAM interface providing less voltage and higher speed successor. DDR3L SDRAM modules support 1066/1333MHz for DDR modules. DDR3L delivers increased system bandwidth and improved performance to provide its higher bandwidth and its increase in performance at a lower power.

• Graphics

The integrated Intel® HD graphics engine delivers an excellent blend of graphics performance and features to meet business needs. It provides excellent video and 3D graphics with outstanding graphics responsiveness. These enhancements deliver the performance and compatibility needed for today's and tomorrow's business applications. Supports HDMI, DVI and DP interfaces for up to 3 display outputs.

• Serial ATA

Serial ATA is a storage interface that is compliant with SATA 1.0a specification. With speed of up to 3Gb/s (SATA 2.0), it improves hard drive performance faster than the standard parallel ATA whose data transfer rate is 100MB/s.

• Gigabit LAN

The Intel® I210 Gigabit LAN controller supports up to 1Gbps data transmission.

• USB

The system board supports the new USB 3.0. It is capable of running at a maximum transmission speed of up to 5 Gbit/s (625 MB/s) and is faster than USB 2.0 (480 Mbit/s, or 60 MB/s) and USB 1.1 (12Mb/s). USB 3.0 reduces the time required for data transmission, reduces power consumption, and is backward compatible with USB 2.0. It is a marked improvement in device transfer speeds between your computer and a wide range of simultaneously accessible external Plug and Play peripherals.

Chapter 2 - Concept

COM Express Module Standards

The figure below shows the dimensions of the different types of COM Express modules.

BT9A3 is a COM Express Mini. The dimension is 84mm x 55mm.

- ⊙ Common for all Form Factors
- Extended only
- Basic only
- ⌚ Compact only
- ⌚ Compact and Basic only
- ⌚ Mini only

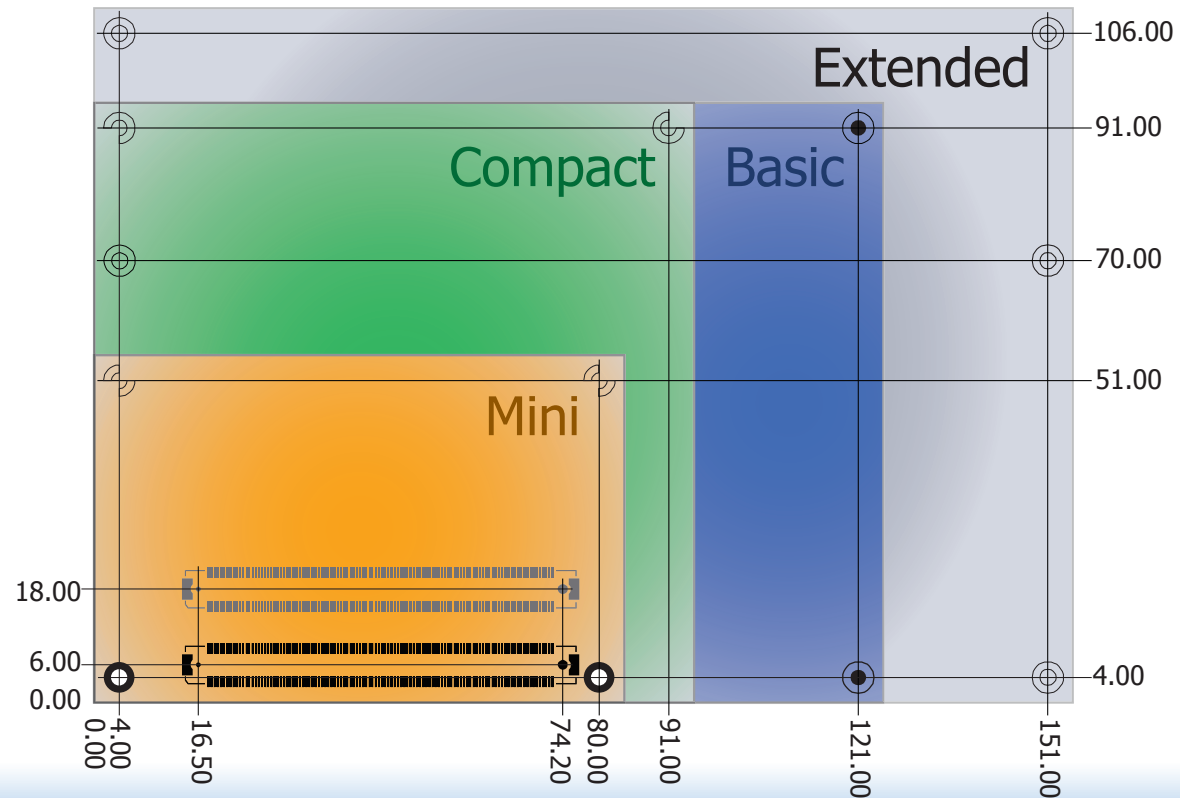

Specification Comparison Table

The table below shows the COM Express standard specifications and the corresponding specifications supported on the BT9A3 module.

Connector	Feature	COM Express Module Base Specification Type 10 (No IDE or PCI, add DDI+ USB3) Min / Max	DFI BT9A3 Type 10
A-B	System I/O		
A-B	PCI Express Lanes 0 - 5	1 / 4	3
A-B	LVDS Channel A	0 / 1	1
A-B	LVDS Channel B	NA	NA
A-B	eDP on LVDS CH A pins	0 / 1	0
A-B	VGA Port	NA	NA
A-B	TV-Out	NA	NA
A-B	DDI 0	0/1	1
A-B ⁵	Serial Ports 1 - 2	0 / 2	2
A-B	CAN interface on SER1	0 / 1	0
A-B	SATA / SAS Ports	1 / 2	2
A-B	AC'97 / HDA Digital Interface	0 / 1	1
A-B	USB 2.0 Ports	4 / 8	8
A-B	USB Client	0 / 1	0
A-B	USB 3.0 Ports	0/2	1
A-B	LAN Port 0	1 / 1	1
A-B	Express Card Support	0/2	2
A-B	LPC Bus	1 / 1	1
A-B	SPI	1 / 2	1
A-B	System Management		
A-B ⁶	SDIO (muxed on GPIO)	0 / 1	0
A-B ⁶	General Purpose I/O	8 / 8	8
A-B	SMBus	1 / 1	1
A-B	I2C	1 / 1	1
A-B	Watchdog Timer	0 / 1	1
A-B	Speaker Out	1 / 1	1
A-B	External BIOS ROM Support	0 / 2	1
A-B	Reset Functions	1 / 1	1



Note:

- 5 Indicates 12V-tolerant features on former VCC_12V signals.
- 6 Cells in the connected columns spanning rows provide a rough approximation of features sharing connector pins.

Connector	Feature	COM Express Module Base Specification Type 6 (No IDE or PCI, add DDI+ USB3) Min / Max	DFI BT9A3 Type 10
A-B	Power Management		
A-B	Thermal Protection	0 / 1	1
A-B	Battery Low Alarm	0 / 1	1
A-B	Suspend/Wake Signals	0 / 3	3
A-B	Power Button Support	1 / 1	1
A-B	Power Good	1 / 1	1
A-B	VCC_5V_SBY Contacts	4 / 4	4
A-B ⁵	Sleep Input	0 / 1	1
A-B ⁵	Lid Input	0 / 1	1
A-B ⁵	Fan Control Signals	0 / 2	2
A-B	Trusted Platform Modules	0 / 1	0
A-B	Power		
A-B	VCC_12V Contacts	12 / 12	12

Module Pin-out - Required and Optional Features C-D Connector. PICMG® COM Express® Revision 2.1

Connector	Feature	COM Express Module Base Specification Type 10 (No IDE or PCI, add DDI+ USB3) Min / Max	DFI BT9A3 Type 10
C-D	System I/O		
C-D ⁶	PCI Express Lanes 16 - 31	NA	NA
	PCI Express Graphics (PEG)	NA	NA
	Muxed SDVO Channels 1 - 2	NA	NA
C-D ⁶	PCI Express Lanes 6 - 15	NA	NA
	PCI Bus - 32 Bit	NA	NA
	PATA Port	NA	NA
	LAN Ports 1 - 2	NA	NA
	DDIs 1 - 3	NA	NA
	USB 3.0 Ports	NA	NA
C-D	Power		
C-D	VCC_12V Contacts	NA	NA

Chapter 3 - Hardware Installation

Board Layout

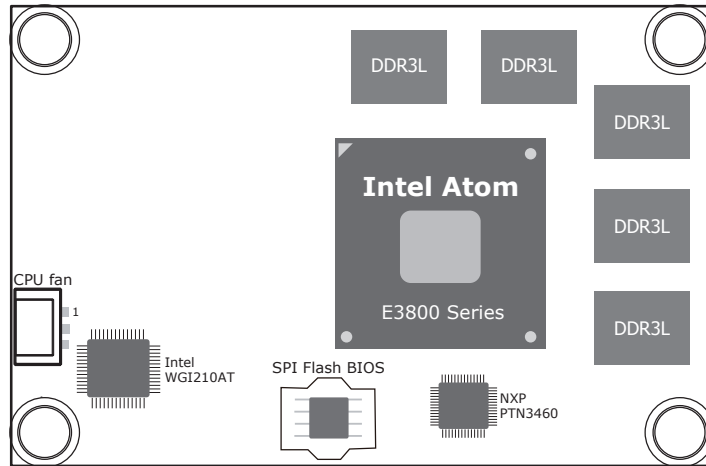

Top View

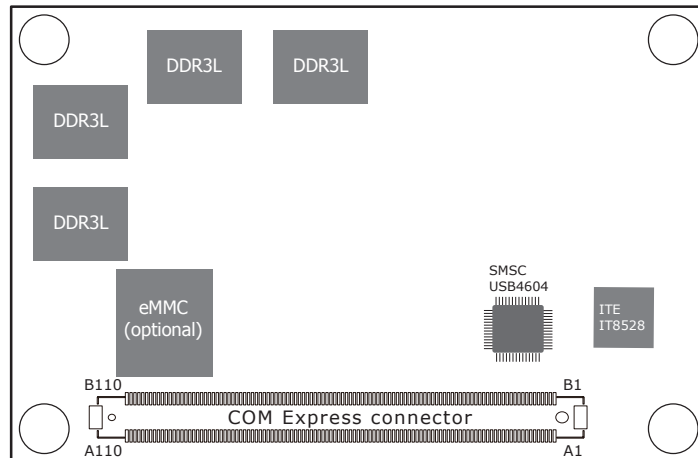

Bottom View

Block Diagram

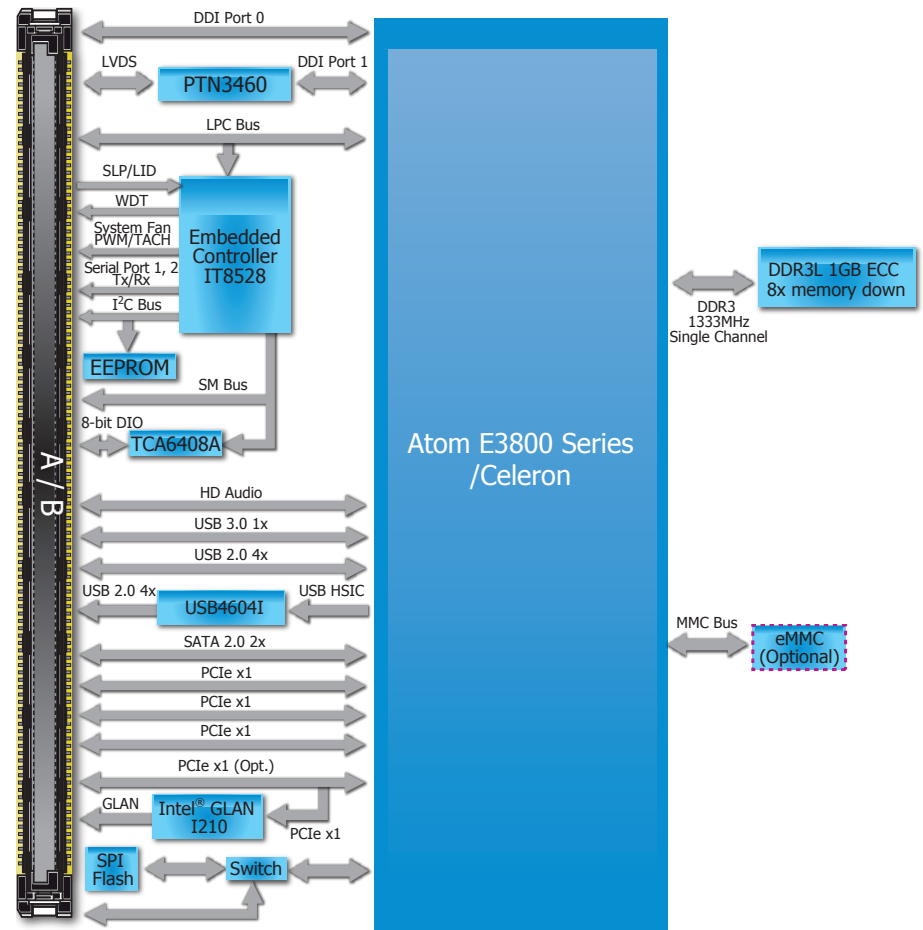

Mechanical Diagram

BT9A3 Module with Heat Sink

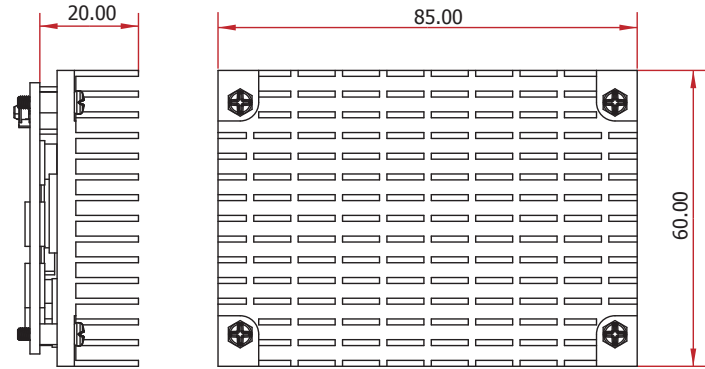

BT9A3 Module

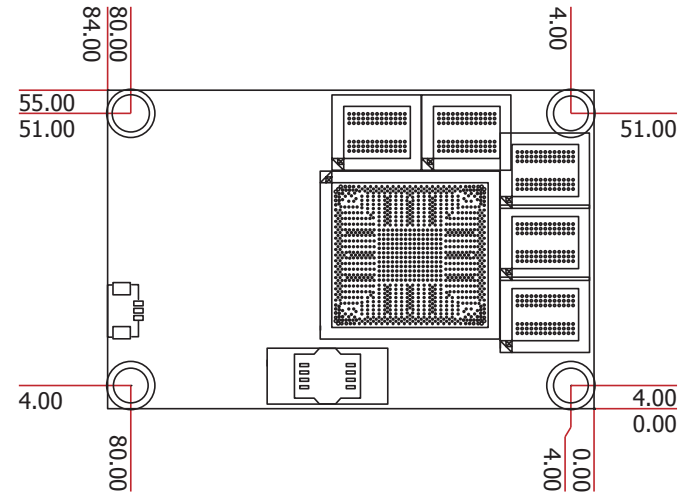

Top View

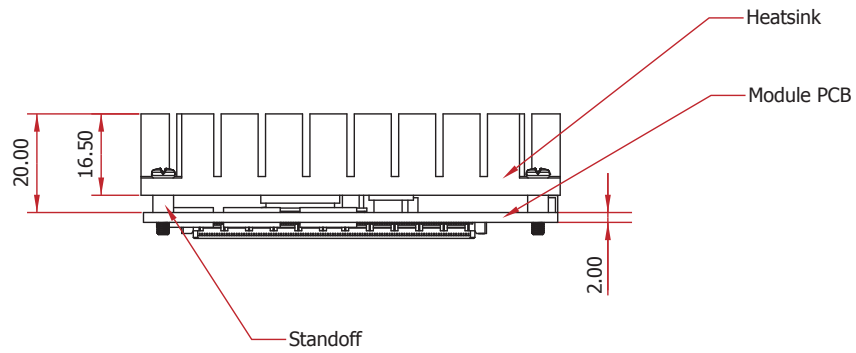

Side View of the Module with Heat Sink and Carrier Board

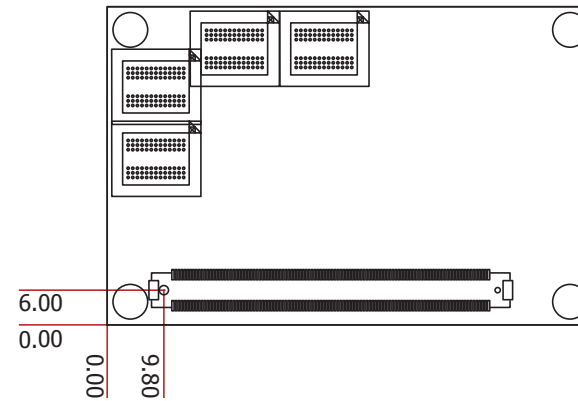

Bottom View



Important:

Electrostatic discharge (ESD) can damage your board, processor, disk drives, add-in boards, and other components. Perform installation procedures at an ESD workstation only. If such a station is not available, you can provide some ESD protection by wearing an antistatic wrist strap and attaching it to a metal part of the system chassis. If a wrist strap is unavailable, establish and maintain contact with the system chassis throughout any procedures requiring ESD protection.

System Memory

The system board is equipped with nine DDR3L memory chips onboard.

- 2GB/4GB DDR3L ECC memory down
- Supports DDR3L 1333MHz (-E45/-E27/-J00/-N30/-N07)
Supports DDR3L 1066MHz (-E26/-E25/-E15)
- Supports single channel memory interface

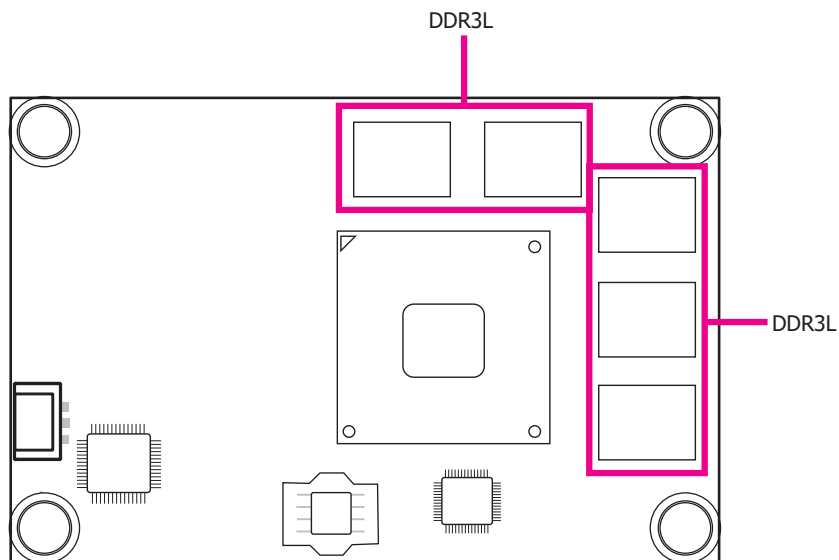

Top View

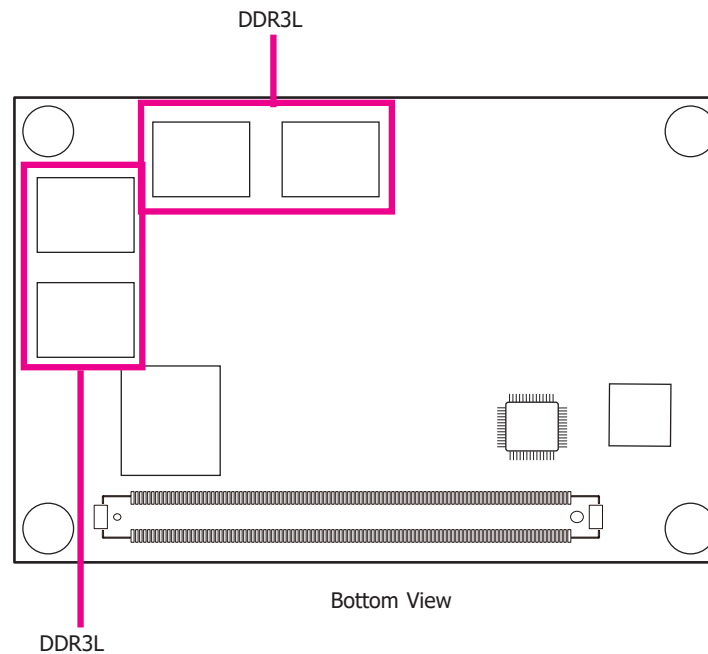

Bottom View

Connectors

CPU Fan Connector

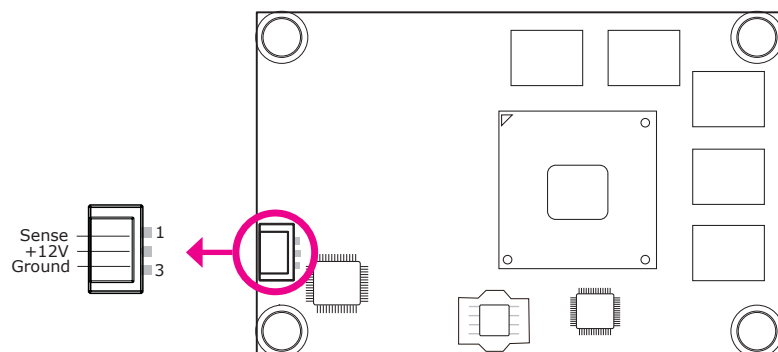

Connect the CPU fan's cable connector to the CPU fan connector on the board. The cooling fan will provide adequate airflow throughout the chassis to prevent overheating the CPU and board components.

BIOS Setting

"Module Board H/W Monitor" submenu in the Advanced menu of the BIOS will display the current speed of the cooling fan. Refer to chapter 3 of the manual for more information.

COM Express Connector

The COM Express connector is used to interface the BT9A3 COM Express board to a carrier board. Connect the COM Express connector (located on the solder side of the board) to the COM Express connector on the carrier board.

Refer to the "Installing BT9A3 onto a Carrier Board" section for more information.

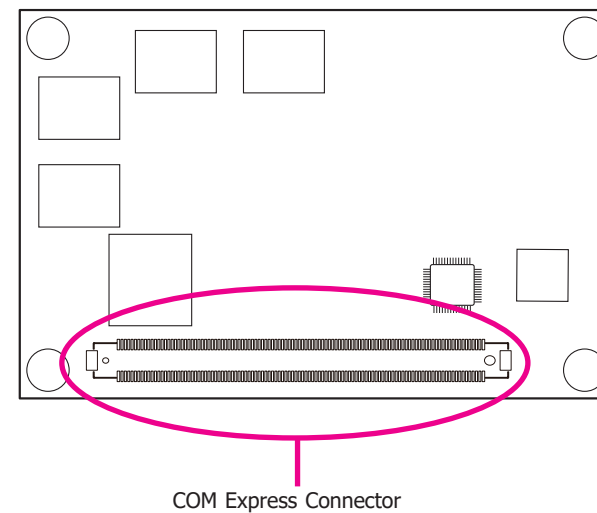

Refer to the following pages for the pin functions of the connector.

COM Express Connector

Row A		Row B	
A1	GND (FIXED)	B1	GND (FIXED)
A2	GBE0_MDI3-	B2	GBE0_ACT#
A3	GBE0_MDI3+	B3	LPC_FRAME#
A4	GBE0_LINK100#	B4	LPC_AD0
A5	GBE0_LINK1000#	B5	LPC_AD1
A6	GBE0_MDI2-	B6	LPC_AD2
A7	GBE0_MDI2+	B7	LPC_AD3
A8	GBE0_LINK#	B8	LPC_DRQ0#
A9	GBE0_MDI1-	B9	LPC_DRQ1#
A10	GBE0_MDI1+	B10	LPC_CLK
A11	GND (FIXED)	B11	GND (FIXED)
A12	GBE0_MDI0-	B12	PWRBTN#
A13	GBE0_MDI0+	B13	SMB_CK
A14	GBE0_CTREF	B14	SMB_DAT
A15	SUS_S3#	B15	SMB_ALERT#
A16	SATA0_TX+	B16	SATA1_TX+
A17	SATA0_TX-	B17	SATA1_TX-
A18	SUS_S4#	B18	SUS_STAT#
A19	SATA0_RX+	B19	SATA1_RX+
A20	SATA0_RX-	B20	SATA1_RX-
A21	GND (FIXED)	B21	GND (FIXED)
A22	USB_SSRX0-	B22	USB_SSTX0-
A23	USB_SSRX0+	B23	USB_SSTX0+
A24	SUS_S5#	B24	PWR_OK
A25	USB_SSRX1-	B25	USB_SSTX1-
A26	USB_SSRX1+	B26	USB_SSTX1+
A27	BATLOW#	B27	WDT
A28	(S)ATA_ACT#	B28	AC/HDA_SDIN2
A29	AC/HDA_SYNC	B29	AC/HDA_SDIN1
A30	AC/HDA_RST#	B30	AC/HDA_SDIN0

Row A		Row B	
A31	GND (FIXED)	B31	GND (FIXED)
A32	AC/HDA_BITCLK	B32	SPKR
A33	AC/HDA_SDOUT	B33	I2C_CK
A34	BIOS_DIS0#	B34	I2C_DAT
A35	THRMTRIP#	B35	THRM#
A36	USB6-	B36	USB7-
A37	USB6+	B37	USB7+
A38	USB_6_7_OC#	B38	USB_4_5_OC#
A39	USB4-	B39	USB5-
A40	USB4+	B40	USB5+
A41	GND (FIXED)	B41	GND (FIXED)
A42	USB2-	B42	USB3-
A43	USB2+	B43	USB3+
A44	USB_2_3_OC#	B44	USB_0_1_OC#
A45	USB0-	B45	USB1-
A46	USB0+	B46	USB1+
A47	VCC_RTC	B47	EXCD1_PERST#
A48	EXCD0_PERST#	B48	EXCD1_CPPE#
A49	EXCD0_CPPE#	B49	SYS_RESET#
A50	LPC_SERIRQ	B50	CB_RESET#
A51	GND (FIXED)	B51	GND (FIXED)
A52	RSVD	B52	RSVD
A53	RSVD	B53	RSVD
A54	GPI0	B54	GPO1
A55	RSVD	B55	RSVD

Row A		Row B	
A56	RSVD	B56	RSVD
A57	GND	B57	GPO2
A58	PCIE_TX3+	B58	PCIE_RX3+
A59	PCIE_TX3-	B59	PCIE_RX3-
A60	GND (FIXED)	B60	GND (FIXED)
A61	PCIE_TX2+	B61	PCIE_RX2+
A62	PCIE_TX2-	B62	PCIE_RX2-
A63	GPI1	B63	GPO3
A64	PCIE_TX1+	B64	PCIE_RX1+
A65	PCIE_TX1-	B65	PCIE_RX1-
A66	GND	B66	WAKE0#
A67	GPI2	B67	WAKE1#
A68	PCIE_TX0+	B68	PCIE_RX0+
A69	PCIE_TX0-	B69	PCIE_RX0-
A70	GND(FIXED)	B70	GND (FIXED)
A71	LVDS_A0+	B71	DDI0_PAIR0+
A72	LVDS_A0-	B72	DDI0_PAIR0-
A73	LVDS_A1+	B73	DDI0_PAIR1+
A74	LVDS_A1-	B74	DDI0_PAIR1-
A75	LVDS_A2+	B75	DDI0_PAIR2+
A76	LVDS_A2-	B76	DDI0_PAIR2-
A77	LVDS_VDD_EN	B77	DDI0_PAIR4+
A78	LVDS_A3+	B78	DDI0_PAIR4-
A79	LVDS_A3-	B79	LVDS_BKLT_EN
A80	GND (FIXED)	B80	GND (FIXED)
A81	LVDS_A_CK+	B81	DDI0_PAIR3+
A82	LVDS_A_CK-	B82	DDI0_PAIR3-
A83	LVDS_I2C_CK	B83	LVDS_BKLT_CTRL
A84	LVDS_I2C_DAT	B84	VCC_5V_SBY
A85	GPI3	B85	VCC_5V_SBY

Row A		Row B	
A86	RSVD	B86	VCC_5V_SBY
A87	eDP_HPD	B87	VCC_5V_SBY
A88	PCIE_CLK_REF+	B88	BIOS_DIS1#
A89	PCIE0_CK_REF-	B89	DD0_HPD
A90	GND (FIXED)	B90	GND (FIXED)
A91	SPI_POWER	B91	DDI0_PAIR5+
A92	SPI_MISO	B92	DDI0_PAIR5-
A93	GPO0	B93	DDI0_PAIR6+
A94	SPI_CLK	B94	DDI0_PAIR6-
A95	SPI_MOSI	B95	DDI0_DDC_AUX_SEL
A96	TPM_PP	B96	USB_HOST_PRSN
A97	TYPE10#	B97	SPI_CS#
A98	SER0_TX	B98	DDI0_CTRLCLK_AUX+
A99	SER0_RX	B99	DDI0_CTRLCLK_AUX-
A100	GND (FIXED)	B100	GND (FIXED)
A101	SER1_TX	B101	FAN_PWMOUT
A102	SER1_RX	B102	FAN_TACHIN
A103	LID#	B103	SLEEP#
A104	VCC_12V	B104	VCC_12V
A105	VCC_12V	B105	VCC_12V
A106	VCC_12V	B106	VCC_12V
A107	VCC_12V	B107	VCC_12V
A108	VCC_12V	B108	VCC_12V
A109	VCC_12V	B109	VCC_12V
A110	GND (FIXED)	B110	GND (FIXED)

COM Express Connector Signal Description

Pin Types
 I Input to the Module
 O Output from the Module
 I/O Bi-directional input / output signal
 OD Open drain output

AC97/HDA Signals Descriptions

Signal	Pin#	Pin Type	Pwr Rail /Tolerance	BT9A3	Carrier Board	Description
AC/HAD_RST#	A30	O CMOS	3.3V Suspend/3.3V		Connect to CODEC pin 11 RESET#	Reset output to CODEC, active low.
AC/HDA_SYNC	A29	O CMOS	3.3V/3.3V		Connect to CODEC pin 10 SYNC	Sample-synchronization signal to the CODEC(s).
AC/HDA_BITCLK	A32	I/O CMOS	3.3V/3.3V		Connect to CODEC pin 6 BIT_CLK	Serial data clock generated by the external CODEC(s).
AC/HDA_SDOOUT	A33	O CMOS	3.3V/3.3V		Connect to CODEC pin 5 SDATA_OUT	Serial TDM data output to the CODEC.
AC/HDA_SDIN2	B28	I/O CMOS	3.3V Suspend/3.3V		Connect 33 Ω in series to CODEC2 pin 8 SDATA_IN	Serial TDM data inputs from up to 3 CODECS.
AC/HDA_SDIN1	B29	I/O CMOS	3.3V Suspend/3.3V		Connect 33 Ω in series to CODEC1 pin 8 SDATA_IN	
AC/HDA_SDIN0	B30	I/O CMOS	3.3V Suspend/3.3V		Connect 33 Ω in series to CODEC0 pin 8 SDATA_IN	

Gigabit Ethernet Signals Descriptions

Signal	Pin#	Pin Type	Pwr Rail /Tolerance	BT9A3	Carrier Board	Description
GBE0_MDIO+	A13	I/O Analog	3.3V max Suspend		Connect to Magnetics Module MDIO+/-	Gigabit Ethernet Controller 0: Media Dependent Interface Differential Pairs 0,1,2,3. The MDI can operate in 1000, 100 and 10 Mbit / sec modes. Some pairs are unused in some modes, per the following: 1000BASE-T 100BASE-TX 10BASE-T MDI[0]+/- B1_DA+/- TX+/- TX+/- MDI[1]+/- B1_DB+/- RX+/- RX+/- MDI[2]+/- B1_DC+/- MDI[3]+/- B1_DD+/-
GBE0_MDIO-	A12	I/O Analog	3.3V max Suspend		Connect to Magnetics Module MDI1+/-	
GBE0_MDII+	A10	I/O Analog	3.3V max Suspend		Connect to Magnetics Module MDI2+/-	
GBE0_MDI1-	A9	I/O Analog	3.3V max Suspend		Connect to Magnetics Module MDI3+/-	
GBE0_MDI2+	A7	I/O Analog	3.3V max Suspend			
GBE0_MDI2-	A6	I/O Analog	3.3V max Suspend			
GBE0_MDI3+	A3	I/O Analog	3.3V max Suspend			
GBE0_MDI3-	A2	I/O Analog	3.3V max Suspend			
GBE0_ACT#	B2	OD CMOS	3.3V Suspend/3.3V		Connect to LED and recommend current limit resistor 150Ω to 3.3VSB	Gigabit Ethernet Controller 0 activity indicator, active low.
GBE0_LINK#	A8	OD CMOS	3.3V Suspend/3.3V		NC	Gigabit Ethernet Controller 0 link indicator, active low.
GBE0_LINK100#	A4	OD CMOS	3.3V Suspend/3.3V		Connect to LED and recommend current limit resistor 150Ω to 3.3VSB	Gigabit Ethernet Controller 0 100 Mbit / sec link indicator, active low.
GBE0_LINK1000#	A5	OD CMOS	3.3V Suspend/3.3V		Connect to LED and recommend current limit resistor 150Ω to 3.3VSB	Gigabit Ethernet Controller 0 1000 Mbit / sec link indicator, active low.

SATA Signals Descriptions

Signal	Pin#	Pin Type	Pwr Rail /Tolerance	BT9A3	Carrier Board	Description
SATA0_TX+	A16	O SATA	AC coupled on Module	AC Coupling capacitor	Connect to SATA0 Conn TX pin	Serial ATA or SAS Channel 0 transmit differential pair.
SATA0_TX-	A17	O SATA	AC coupled on Module	AC Coupling capacitor		
SATA0_RX+	A19	I SATA	AC coupled on Module	AC Coupling capacitor	Connect to SATA0 Conn RX pin	Serial ATA or SAS Channel 0 receive differential pair.
SATA0_RX-	A20	I SATA	AC coupled on Module	AC Coupling capacitor		
SATA1_TX+	B16	O SATA	AC coupled on Module	AC Coupling capacitor	Connect to SATA1 Conn TX pin	Serial ATA or SAS Channel 1 transmit differential pair.
SATA1_TX-	B17	O SATA	AC coupled on Module	AC Coupling capacitor		
SATA1_RX+	B19	I SATA	AC coupled on Module	AC Coupling capacitor	Connect to SATA1 Conn RX pin	Serial ATA or SAS Channel 1 receive differential pair.
SATA1_RX-	B20	I SATA	AC coupled on Module	AC Coupling capacitor		
ATA_ACT#	A28	I/O CMOS	3.3V / 3.3V	PU 10K to 3.3V	Connect to LED and recommend current limit resistor 220Ω to 3.3V	ATA (parallel and serial) or SAS activity indicator, active low.

PCI Express Lanes Signals Descriptions

Signal	Pin#	Pin Type	Pwr Rail /Tolerance	BT9A3	Carrier Board	Description
PCIE_TX0+	A68	O PCIE	AC coupled on Module	AC Coupling capacitor	Connect to PCIE device or slot	PCI Express Differential Transmit Pairs 0
PCIE_TX0-	A69			AC Coupling capacitor		
PCIE_RX0+	B68	I PCIE	AC coupled off Module		Device - Connect AC Coupling cap 0.1uF Slot - Connect to PCIE Conn pin	PCI Express Differential Receive Pairs 0
PCIE_RX0-	B69					
PCIE_TX1+	A64	O PCIE	AC coupled on Module	AC Coupling capacitor	Connect to PCIE device or slot	PCI Express Differential Transmit Pairs 1
PCIE_TX1-	A65			AC Coupling capacitor		
PCIE_RX1+	B64	I PCIE	AC coupled off Module		Device - Connect AC Coupling cap 0.1uF Slot - Connect to PCIE Conn pin	PCI Express Differential Receive Pairs 1
PCIE_RX1-	B65					
PCIE_TX2+	A61	O PCIE	AC coupled on Module	AC Coupling capacitor	Connect to PCIE device or slot	PCI Express Differential Transmit Pairs 2
PCIE_TX2-	A62			AC Coupling capacitor		
PCIE_RX2+	B61	I PCIE	AC coupled off Module		Device - Connect AC Coupling cap 0.1uF Slot - Connect to PCIE Conn pin	PCI Express Differential Receive Pairs 2
PCIE_RX2-	B62					
PCIE_TX3+	A58	O PCIE	AC coupled on Module	NA	NA	PCI Express Differential Transmit Pairs 3 (NA for BT9A3)
PCIE_TX3-	A59			NA	NA	
PCIE_RX3+	B58	I PCIE	AC coupled off Module	NA	NA	PCI Express Differential Receive Pairs 3 (NA for BT9A3)
PCIE_RX3-	B59			NA	NA	
PCIE0_CK_REF+	A88	O PCIE	PCIE		Connect to PCIE device, PCIE CLK Buffer or slot	Reference clock output for all PCI Express and PCI Express Graphics lanes.
PCIE0_CK_REF-	A89					

ExpressCard Signals Descriptions

Signal	Pin#	Pin Type	Pwr Rail /Tolerance	BT9A3	Carrier Board	Description
EXCD0_CPPE#	A49	I CMOS	3.3V /3.3V	PU 10k to 3.3V		PCI ExpressCard: PCI Express capable card request, active low, one per card
EXCD1_CPPE#	B48			PU 10k to 3.3V		
EXCD0_PERST#	A48	O CMOS	3.3V /3.3V			PCI ExpressCard: reset, active low, one per card
EXCD1_PERST#	B47					

DDI Signals Descriptions

Signal	Pin#	Pin Type	Pwr Rail /Tolerance	BT9A3	Carrier Board	Description
DDI1_PAIR0+/DP0_LANE0+	B71	O PCIE	AC coupled off Module		Connect AC Coupling Capacitors 0.1uF to Device	DDI 1 Pair 0 differential pairs/Serial Digital Video B red output differential pair
DDI1_PAIR0-/DP0_LANE0-	B72			Connect AC Coupling Capacitors 0.1uF to Device		
DDI1_PAIR1+/DP0_LANE1+	B73	O PCIE	AC coupled off Module		Connect AC Coupling Capacitors 0.1uF to Device	DDI 1 Pair 1 differential pairs/Serial Digital Video B green output differential pair
DDI1_PAIR1-/DP0_LANE1-	B74			Connect AC Coupling Capacitors 0.1uF to Device		
DDI1_PAIR2+/DP0_LANE2+	B75	O PCIE	AC coupled off Module		Connect AC Coupling Capacitors 0.1uF to Device	DDI 1 Pair 2 differential pairs/Serial Digital Video B blue output differential pair
DDI1_PAIR2-/DP0_LANE2-	B76			Connect AC Coupling Capacitors 0.1uF to Device		
DDI1_PAIR3+/DP0_LANE3+	B81	O PCIE	AC coupled off Module		Connect AC Coupling Capacitors 0.1uF to Device	DDI 1 Pair 3 differential pairs/Serial Digital Video B clock output differential pair.
DDI1_PAIR3-/DP0_LANE3-	B82			Connect AC Coupling Capacitors 0.1uF to Device		
DDI1_PAIR4+	B77			NA	NA	NA for BT9A3
DDI1_PAIR4-	B78			NA	NA	
DDI1_PAIR5+	B91			NA	NA	NA for BT9A3
DDI1_PAIR5-	B92			NA	NA	
DDI1_PAIR6+	B93			NA	NA	NA for BT9A3
DDI1_PAIR6-	B94			NA	NA	
DDI1_CTRLCLK_AUX+/DP0_AUX+	B98	I/O PCIE	AC coupled on Module	PD 49.9K to GND (S/W IC between Rpu/PCH)	Connect to DP AUX+	DP AUX+ function if DDI1_DDC_AUX_SEL is no connect
		I/O OD CMOS	3.3V / 3.3V	PU 2.2K to 3.3V, PD 49.9K to GND	Connect to HDMI/DVI I2C CTRLCLK	HDMI/DVI I2C CTRLCLK if DDI1_DDC_AUX_SEL is pulled high
DDI1_CTRLCLK_AUX-/DP0_AUX-	B99	I/O PCIE	AC coupled on Module	PU 100K to 3.3V	Connect to DP AUX-	DP AUX- function if DDI1_DDC_AUX_SEL is no connect
		I/O OD CMOS	3.3V / 3.3V	PU 2.2K to 3.3V/PU 100K to 3.3V	Connect to HDMI/DVI I2C CTRLDATA	HDMI/DVI I2C CTRLDATA if DDI1_DDC_AUX_SEL is pulled high
DDI1_HPD/DP0_HPD	B89	I CMOS	3.3V / 3.3V	PD 1M to GND	PD 1M and Connect to device Hot Plug Detect	DDI Hot-Plug Detect
DDI1_DDC_AUX_SEL	B95	I CMOS	3.3V / 3.3V	PD 1M to GND	PU 100K to 3.3V for DDC(HDMI/DVI)	Selects the function of DDI1_CTRLCLK_AUX+ and DDI1_CTRLDATA_AUX-. This pin shall have a 1M pull-down to logic ground on the Module. If this input is floating the AUX pair is used for the DP AUX+/- signals. If pulled-high the AUX pair contains the CTRLCLK and CTRLDATA signals ***** DDI[n]_DDC_AUX_SEL shall be pulled to 3.3V on the Carrier with a 100K Ohm resistor to configure the DDI[n]_AUX pair as the DDC channel. Carrier DDI[n]_DDC_AUX_SEL should be connected to pin 13 of the DisplayPort

USB Signals Descriptions

Signal	Pin#	Pin Type	Pwr Rail /Tolerance	BT9A3	Carrier Board	Description
USB0+	A46	I/O USB	3.3V Suspend/3.3V		Connect 90Ω @100MHz Common Choke in series and ESD suppressors to GND to USB connector	USB differential pairs 0
USB0-	A45					
USB1+	B46	I/O USB	3.3V Suspend/3.3V		Connect 90Ω @100MHz Common Choke in series and ESD suppressors to GND to USB connector	USB differential pairs 1
USB1-	B45					
USB2+	A43	I/O USB	3.3V Suspend/3.3V		Connect 90Ω @100MHz Common Choke in series and ESD suppressors to GND to USB connector	USB differential pairs 2
USB2-	A42					
USB3+	B43	I/O USB	3.3V Suspend/3.3V		Connect 90Ω @100MHz Common Choke in series and ESD suppressors to GND to USB connector	USB differential pairs 3
USB3-	B42					
USB4+	A40	I/O USB	3.3V Suspend/3.3V		Connect 90Ω @100MHz Common Choke in series and ESD suppressors to GND to USB connector	USB differential pairs 4
USB4-	A39					
USB5+	B40	I/O USB	3.3V Suspend/3.3V		Connect 90Ω @100MHz Common Choke in series and ESD suppressors to GND to USB connector	USB differential pairs 5
USB5-	B39					
USB6+	A37	I/O USB	3.3V Suspend/3.3V		Connect 90Ω @100MHz Common Choke in series and ESD suppressors to GND to USB connector	USB differential pairs 6
USB6-	A36					
USB7+	B37	I/O USB	3.3V Suspend/3.3V		Connect 90Ω @100MHz Common Choke in series and ESD suppressors to GND to USB connector	USB differential pairs 7
USB7-	B36					
USB_0_1_OC#	B44	I CMOS	3.3V Suspend/3.3V	PU 10k to 3.3A	Connect to Overcurrent of USB Power Switch	USB over-current sense, USB channels 0 and 1. A pull-up for this line shall be present on the Module. An open drain driver from a USB current monitor on the Carrier Board may drive this line low. Do not pull this line high on the Carrier Board.
USB_2_3_OC#	A44	I CMOS	3.3V Suspend/3.3V	PU 10k to 3.3A	Connect to Overcurrent of USB Power Switch	USB over-current sense, USB channels 2 and 3. A pull-up for this line shall be present on the Module. An open drain driver from a USB current monitor on the Carrier Board may drive this line low. Do not pull this line high on the Carrier Board.
USB_4_5_OC#	B38	I CMOS	3.3V Suspend/3.3V	PU 10k to 3.3A	Connect to Overcurrent of USB Power Switch	USB over-current sense, USB channels 4 and 5. A pull-up for this line shall be present on the Module. An open drain driver from a USB current monitor on the Carrier Board may drive this line low. Do not pull this line high on the Carrier Board.
USB_6_7_OC#	A38	I CMOS	3.3V Suspend/3.3V	PU 10k to 3.3A	Connect to Overcurrent of USB Power Switch	USB over-current sense, USB channels 6 and 7. A pull-up for this line shall be present on the Module. An open drain driver from a USB current monitor on the Carrier Board may drive this line low. Do not pull this line high on the Carrier Board.
USB_SSTX0+	B23	O PCIE	AC coupled on Module		Connect Common Choke in series and ESD suppressors to GND to USB connector	Additional transmit signal differential pairs for the SuperSpeed USB data path.
USB_SSTX0-	B22					
USB_SSRX0+	A23	I PCIE	AC coupled off Modul		Connect Common Choke in series and ESD suppressors to GND to USB connector	Additional receive signal differential pairs for the SuperSpeed USB data path.
USB_SSRX0-	A22					
USB_SSTX1+	B26	O PCIE	AC coupled on Module	NA	NA	Additional transmit signal differential pairs for the SuperSpeed USB data path.(NA for BT9A3)
USB_SSTX1-	B25			NA	NA	
USB_SSRX1+	A26	I PCIE	AC coupled off Modul	NA	NA	Additional receive signal differential pairs for the SuperSpeed USB data path.(NA for BT9A3)
USB_SSRX1-	A25			NA	NA	
USB_HOST_PRSNNT	B96	I CMOS	3.3V Suspend/3.3V	NA	NA	Module USB client may detect the presence of a USB host. A high value(NA for BT9A3) indicates that a host is present.

LVDS Signals Descriptions

Signal	Pin#	Pin Type	Pwr Rail /Tolerance	BT9A3	Carrier Board	Description
LVDS_A0+	A71	O LVDS	LVDS		Connect to LVDS connector	LVDS Channel A differential pairs
LVDS_A0-	A72					
LVDS_A1+	A73					
LVDS_A1-	A74					
LVDS_A2+	A75	O LVDS	LVDS		Connect to LVDS connector	LVDS Channel A differential pairs
LVDS_A2-	A76					
LVDS_A3+	A78	O LVDS	LVDS		Connect to LVDS connector	LVDS Channel A differential clock
LVDS_A3-	A79					
LVDS_A_CK+	A81					
LVDS_A_CK-	A82	O LVDS	LVDS		Connect to LVDS connector	
LVDS_VDD_EN	A77	O CMOS	3.3V / 3.3V		Connect to enable control of LVDS panel power circuit	LVDS panel power enable
LVDS_BKLT_EN	B79	O CMOS	3.3V / 3.3V		Connect to enable control of LVDS panel backlight power circuit.	LVDS panel backlight enable
LVDS_BKLT_CTRL	B83	O CMOS	3.3V / 3.3V		Connect to brightness control of LVDS panel backlight power circuit.	LVDS panel backlight brightness control
LVDS_I2C_CK	A83	I/O OD CMOS	3.3V / 3.3V	PU 2.2K to 3.3V	Connect to DDC clock of LVDS panel	I2C clock output for LVDS display use
LVDS_I2C_DAT	A84	I/O OD CMOS	3.3V / 3.3V	PU 2.2K to 3.3V	Connect to DDC data of LVDS panel	I2C data line for LVDS display use

LPC Signals Descriptions

Signal	Pin#	Pin Type	Pwr Rail /Tolerance	BT9A3	Carrier Board	Description
LPC_AD0	B4	I/O CMOS	3.3V / 3.3V		Connect to LPC device	LPC multiplexed address, command and data bus
LPC_AD1	B5					
LPC_AD2	B6					
LPC_AD3	B7					
LPC_FRAME#	B3	O CMOS	3.3V / 3.3V			LPC frame indicates the start of an LPC cycle
LPC_DRQ0#	B8	I CMOS	3.3V / 3.3V			LPC serial DMA request
LPC_DRQ1#	B9	I/O CMOS	3.3V / 3.3V	PU 8.2K to 3.3V		LPC serial interrupt
LPC_SERIRQ	A50	I/O CMOS	3.3V / 3.3V	PU 8.2K to 3.3V		LPC clock output - 33MHz nominal
LPC_CLK	B10	O CMOS	3.3V / 3.3V			

SPI Signals Descriptions

Signal	Pin#	Pin Type	Pwr Rail /Tolerance	BT9A3	Carrier Board	Description
SPI_CS#	B97	O CMOS	3.3V Suspend/3.3V		Connect a series resistor 33Ω to Carrier Board SPI Device CS# pin	Chip select for Carrier Board SPI - may be sourced from chipset SPI0 or SPI1
SPI_MISO	A92	I CMOS	3.3V Suspend/3.3V		Connect a series resistor 33Ω to Carrier Board SPI Device SO pin	Data in to Module from Carrier SPI
SPI_MOSI	A95	O CMOS	3.3V Suspend/3.3V		Connect a series resistor 33Ω to Carrier Board SPI Device SI pin	Data out from Module to Carrier SPI
SPI_CLK	A94	O CMOS	3.3V Suspend/3.3V		Connect a series resistor 33Ω to Carrier Board SPI Device SCK pin	Clock from Module to Carrier SPI
SPI_POWER	A91	O	3.3V Suspend/3.3V			Power supply for Carrier Board SPI – sourced from Module – nominally 3.3V. The Module shall provide a minimum of 100mA on SPI_POWER. Carriers shall use less than 100mA of SPI_POWER. SPI_POWER shall only be used to power SPI devices on the Carrier
BIOS_DIS0#	A34	I CMOS	NA			Selection straps to determine the BIOS boot device.
BIOS_DIS1#	B88					The Carrier should only float these or pull them low, please refer to COM Express Module Base Specification Revision 2.1 for strapping options of BIOS disable signals.

Serial Interface Signals Descriptions

Signal	Pin#	Pin Type	Pwr Rail /Tolerance	BT9A3	Carrier Board	Description
SER0_TX	A98	O CMOS	5V / 12V(design 3.3v~5V tolerant)		PD 4.7K	General purpose serial port 0 transmitter
SER0_RX	A99	I CMOS	5V / 12V(design 3.3v~5V tolerant)	PU 47K to 3.3V		General purpose serial port 0 receiver
SER1_TX	A101	O CMOS	5V / 12V(design 3.3v~5V tolerant)		PD 4.7K	General purpose serial port 1 transmitter
SER1_RX	A102	I CMOS	5V / 12V(design 3.3v~5V tolerant)	PU 47K to 3.3V		General purpose serial port 1 receiver

Miscellaneous Signal Descriptions

Signal	Pin#	Pin Type	Pwr Rail /Tolerance	BT9A3	Carrier Board	Description
I2C_CK	B33	I/O OD CMOS	3.3V Suspend/3.3V	PU 2.2K to 3V3A_EC		General purpose I2C port clock output
I2C_DAT	B34	I/O OD CMOS	3.3V Suspend/3.3V	PU 2.2K to 3V3A_EC		General purpose I2C port data I/O line
SPKR	B32	O CMOS	3.3V / 3.3V			Output for audio enunciator - the "speaker" in PC-AT systems. This port provides the PC beep signal and is mostly intended for debugging purposes.
WDT	B27	O CMOS	3.3V / 3.3V			Output indicating that a watchdog time-out event has occurred.
FAN_PWNOUT	B101	O OD CMOS	3.3V / 12V			Fan speed control. Uses the Pulse Width Modulation (PWM) technique to control the fan's RPM.
FAN_TACHIN	B102	I OD CMOS	3.3V / 12V			Fan tachometer input for a fan with a two pulse output.
TPM_PP	A96	I CMOS	3.3V / 3.3V			

Power and System Management Signals Descriptions

Signal	Pin#	Pin Type	Pwr Rail /Tolerance	BT9A3	Carrier Board	Description
PWRBTN#	B12	I CMOS	3.3V Suspend/3.3V	PU 10K to 3V3A_EC		A falling edge creates a power button event. Power button events can be used to bring a system out of S5 soft off and other suspend states, as well as powering the system down.
SYS_RESET#	B49	I CMOS	3.3V Suspend/3.3V	PU 10K to 3V3A		Reset button input. Active low request for Module to reset and reboot. May be falling edge sensitive. For situations when SYS_RESET# is not able to reestablish control of the system, PWR_OK or a power cycle may be used.
CB_RESET#	B50	O CMOS	3.3V Suspend/3.3V			Reset output from Module to Carrier Board. Active low. Issued by Module chipset and may result from a low SYS_RESET# input, a low PWR_OK input, a VCC_12V power input that falls below the minimum specification, a watchdog timeout, or may be initiated by the Module software.
PWR_OK	B24	I CMOS	3.3V / 3.3V	PU 10K to 3.3V		Power OK from main power supply. A high value indicates that the power is good. This signal can be used to hold off Module startup to allow Carrier based FPGAs or other configurable devices time to be programmed.
SUS_STAT#	B18	O CMOS	3.3V Suspend/3.3V			Indicates imminent suspend operation; used to notify LPC devices.
SUS_S3#	A15	O CMOS	3.3V Suspend/3.3V			Indicates system is in Suspend to RAM state. Active low output. An inverted copy of SUS_S3# on the Carrier Board may be used to enable the non-standby power on a typical ATX supply.
SUS_S4#	A18	O CMOS	3.3V Suspend/3.3V			Indicates system is in Suspend to Disk state. Active low output.
SUS_S5#	A24	O CMOS	3.3V Suspend/3.3V			Indicates system is in Soft Off state.
WAKE0#	B66	I CMOS	3.3V Suspend/3.3V	NC/PU 10K to 3.3A		PCI Express wake up signal.
WAKE1#	B67	I CMOS	3.3V Suspend/3.3V			General purpose wake up signal. May be used to implement wake-up on PS2 keyboard or mouse activity.
BATLOW#	A27	I CMOS	3.3V Suspend/ 3.3V	PU 10K to 3.3A		Indicates that external battery is low. This port provides a battery-low signal to the Module for orderly transitioning to power saving or power cut-off ACPI modes.
LID#	A103	I OD CMOS	3.3V Suspend/12V	PU 10K to 3V3A_EC		LID switch. Low active signal used by the ACPI operating system for a LID switch.
SLEEP#	B103	I OD CMOS	3.3V Suspend/12V	PU 10K to 3V3A_EC		Sleep button. Low active signal used by the ACPI operating system to bring the system to sleep state or to wake it up again.
THRM#	B35	I CMOS	3.3V / 3.3V	PU 10K to 3.3V		Input from off-Module temp sensor indicating an over-temp situation.
THRMTRIP#	A35	O CMOS	3.3V / 3.3V			Active low output indicating that the CPU has entered thermal shutdown.
SMB_CK	B13	I/O OD CMOS	3.3V Suspend/3.3V	PU 2.2K to 3V3A_EC		System Management Bus bidirectional clock line.
SMB_DAT	B14	I/O OD CMOS	3.3V Suspend/3.3V	PU 2.2K to 3V3A_EC		System Management Bus bidirectional data line.
SMB_ALERT#	B15	I CMOS	3.3V Suspend/3.3V			System Management Bus Alert – active low input can be used to generate an SMI# (System Management Interrupt) or to wake the system.

GPIO Signals Descriptions

Signal	Pin#	Pin Type	Pwr Rail /Tolerance	BT9A3	Carrier Board	Description
GPO0	A93	O CMOS	3.3V / 3.3V			General purpose output pins.
GPO1	B54					
GPO2	B57					
GPO3	B63					
GPI0	A54	I CMOS	PU 100K to 3V3	PU 100K to 3.3V		General purpose input pins.
GPI1	A63			PU 100K to 3.3V		
GPI2	A67			PU 100K to 3.3V		
GPI3	A85			PU 100K to 3.3V		

Power and GND Signal Descriptions						
Signal	Pin#	Pin Type	Pwr Rail /Tolerance	BT9A3	Carrier Board	Description
VCC_12V	A104~A109 B104~B109	Power	4.75V – 20.0V	4.75V – 20.0V		Primary power input: +12V nominal. All available VCC_12V pins on the connector(s) shall be used. The module supplies a wide range of power from 4.75V to 20.0V.
VCC_5V_SBY	B84~B87	Power	4.75V - 5.25V	4.75V - 5.25V		Standby power input: +5.0V nominal. If VCC5_SBY is used, all available VCC_5V_SBY pins on the connector(s) shall be used. Only used for standby and suspend functions. May be left unconnected if these functions are not used in the system design.
VCC_RTC	A47	Power	2.0V - 3.3V	2.0V - 3.3V		Real-time clock circuit-power input. Nominally +3.0V.
GND	A1, A11, A21, A31, A41, A51, A57, A60, A66, A70, A80, A90, A100, A110, B1, B11, B21 ,B31, B41, B51, B60, B70, B80, B90, B100, B110	Power				Ground - DC power and signal and AC signal return path. All available GND connector pins shall be used and tied to Carrier Board GND plane.

Cooling Option

Heat Sink with Cooling Fan



Note:

The system board used in the following illustrations may not resemble the actual board. These illustrations are for reference only.

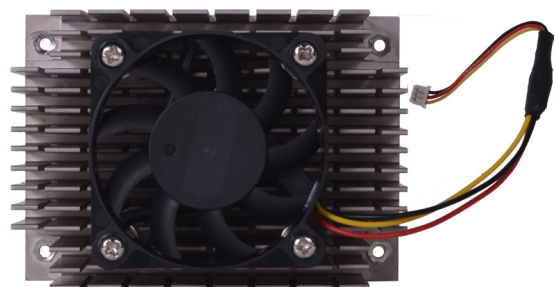

Top View of the Heat Sink

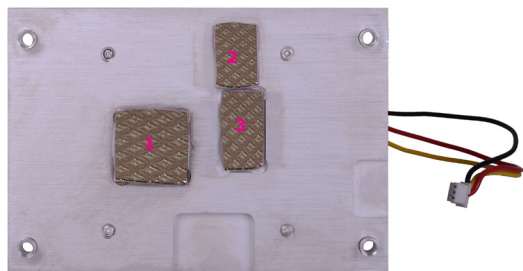

Bottom View of the Heat Sink

- "1," "2" and "3" denote the locations of the thermal pads designed to contact the corresponding components that are on BT9A3.



Important:

Remove the plastic covering from the thermal pads prior to mounting the heat sink onto BT9A3.

Installing BT9A3 onto a Carrier Board



Important:

The carrier board (COM100-B) used in this section is for reference purpose only and may not resemble your carrier board. These illustrations are mainly to guide you on how to install BT9A3 onto the carrier board of your choice.

- [To download COM100-B datasheet and manual](#)

1. Now install the module and heatsink assembly onto the carrier board. The photo below shows the locations of the mounting holes on the carrier board.

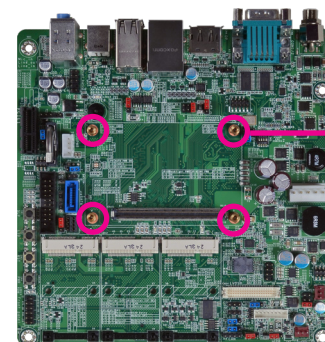

Mounting hole

2. Insert the provided mounting screws into the mounting holes - from the bottom through the top of the carrier board.

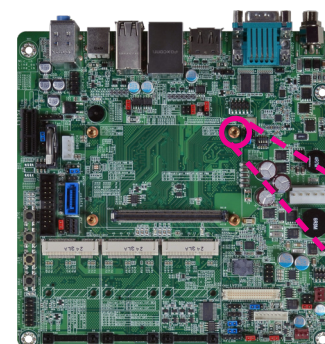

Mounting screws

- While supporting the mounting screw at the bottom, from the top side of the board, fasten a bolt into the screw.

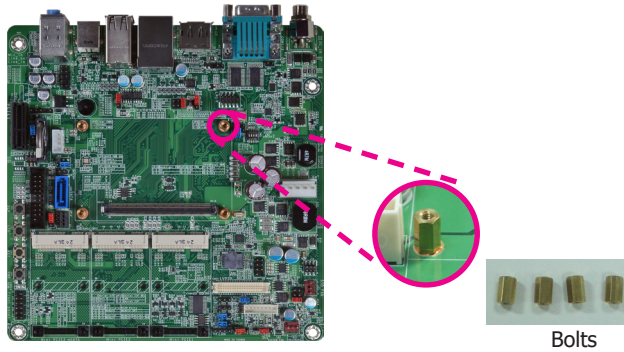

- The photo below shows the solder side of the board with the screws already fixed in place.

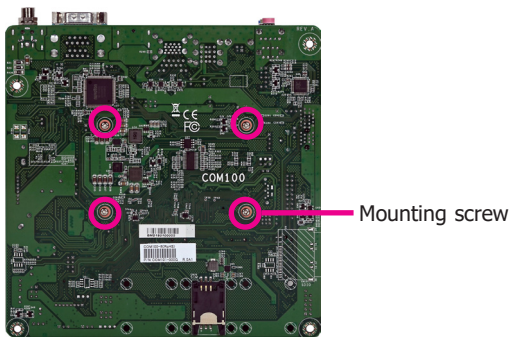

- The photo below shows the component side of the board with the bolts already fixed in place.

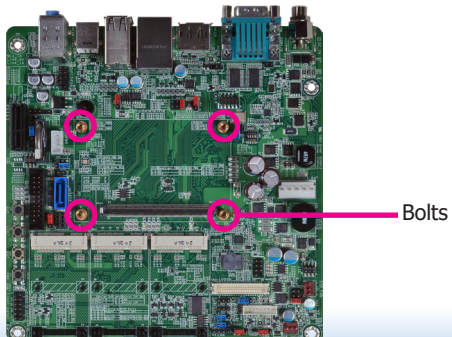

- Grasping BT9A3 by its edges, position it on the top of the carrier board with its mounting holes aligned with the bolts on the carrier board. This will also align the COM Express connectors of the two boards to each other.

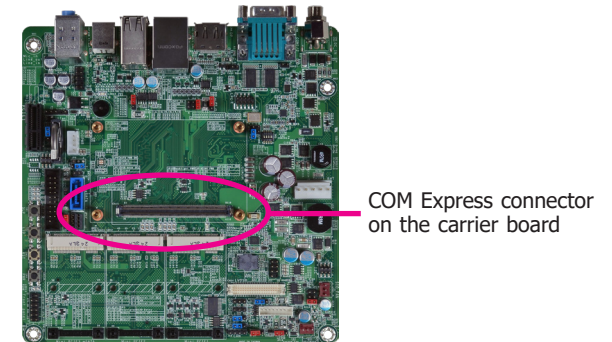
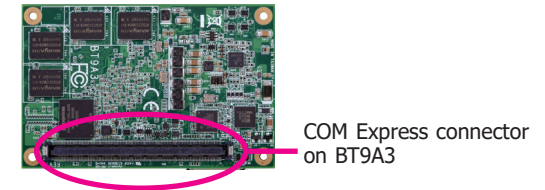

- Press BT9A3 down firmly until it is completely seated on the COM Express connector of the carrier board.

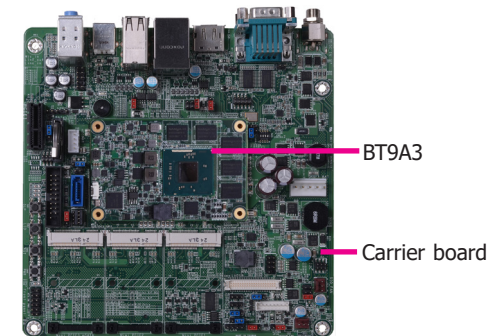

- Use the provided mounting screws to secure BT9A3 with heat sink to the carrier board and then connect the cooling fan's cable to the fan connector on BT9A3. The photo below shows the locations of the long mounting screws.

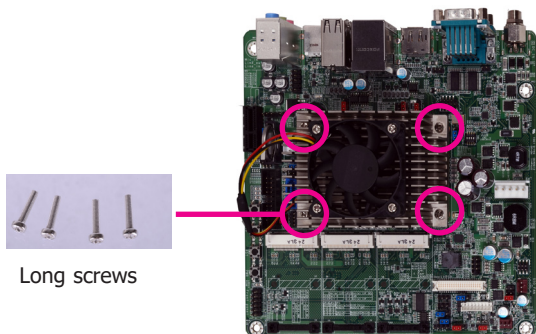

- And then connect the cooling fan's cable to the fan connector on BT9A3.

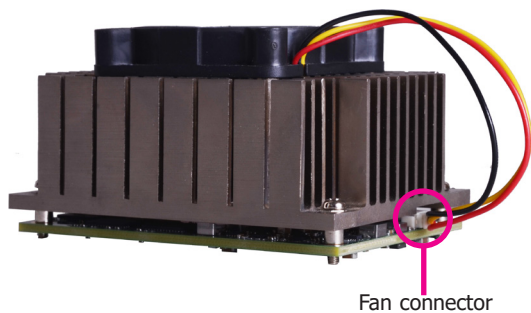

Installing the COM Express Debug Card



Note:

The system board used in the following illustrations may not resemble the actual board. These illustrations are for reference only.

- COMe-LINK2 is the COM Express debug platform installed into COM Express Mini modules for the application of debugging and displaying signals and codes.

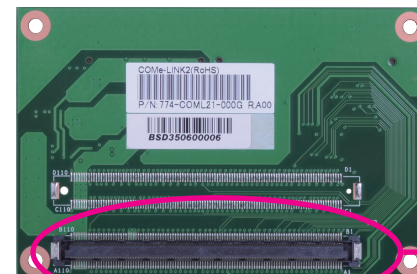
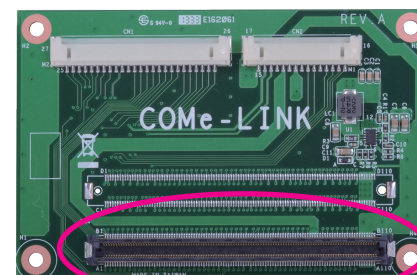

2. Connect the COMe-DEBUG card to COMe-LINK2 via a cable.

COMe-DEBUG

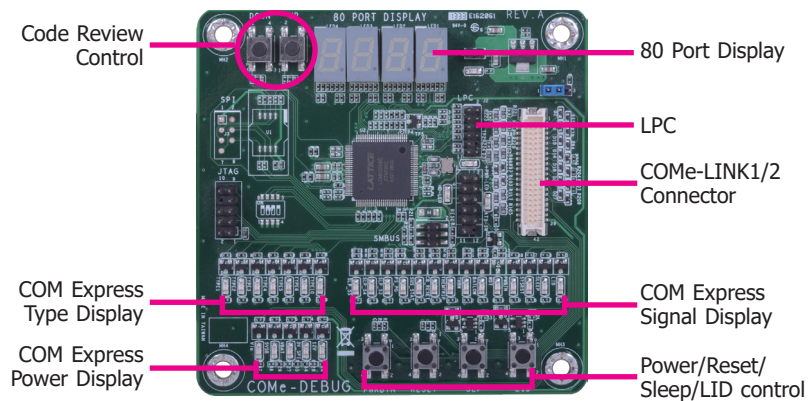

3. Fasten bolts with mounting screws through mounting holes to be fixed in place.

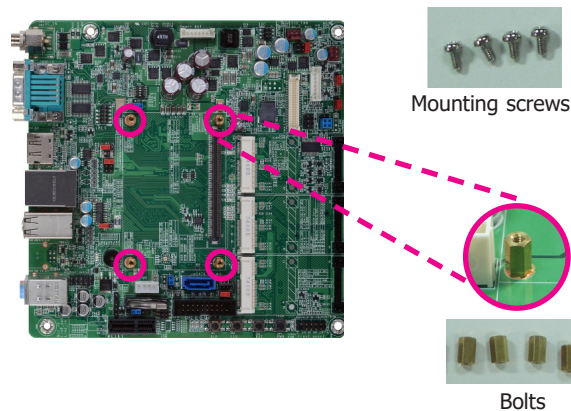

4. Use the provided bolts to fix the COMe-LINK2 debug card onto the carrier board.

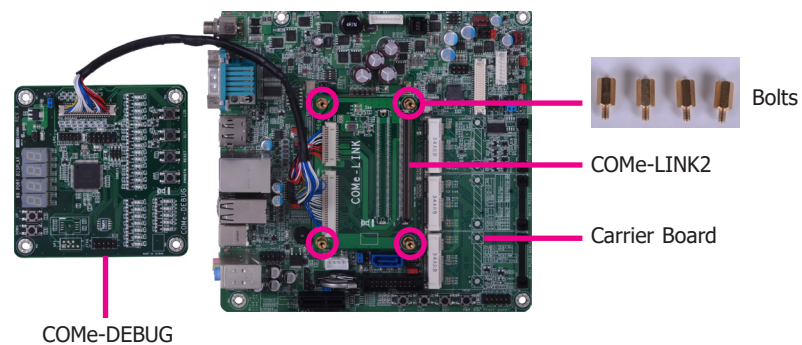
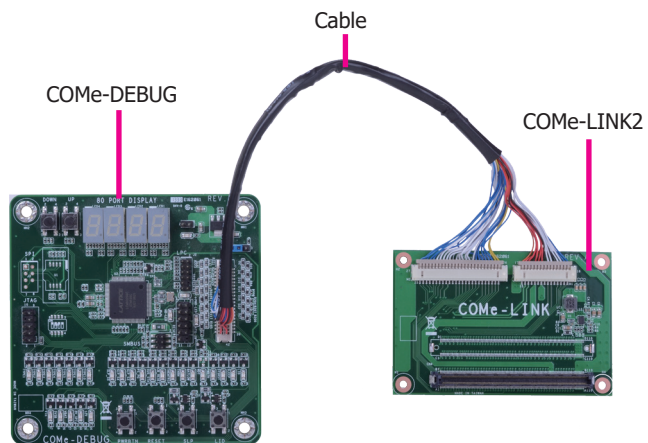

5. Grasp the COM Express Mini module by its edges to press it down on the top of the COMe-LINK2 debug card.

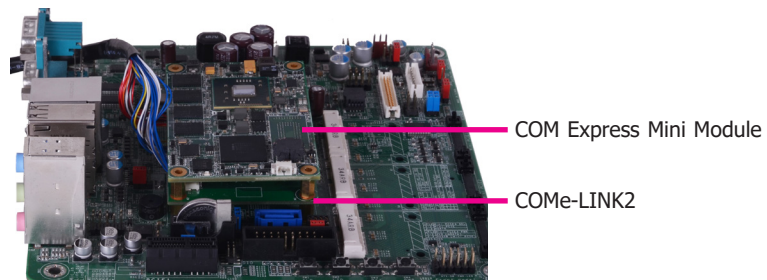

7. Use the long mounting screws to secure the heat sink on the top of the COM Express Mini module and the COMe-LINK2 debug card and connect the cooling fan's cable to the fan connector on the COM Express Mini module. The photo below shows the locations of long mounting screws.

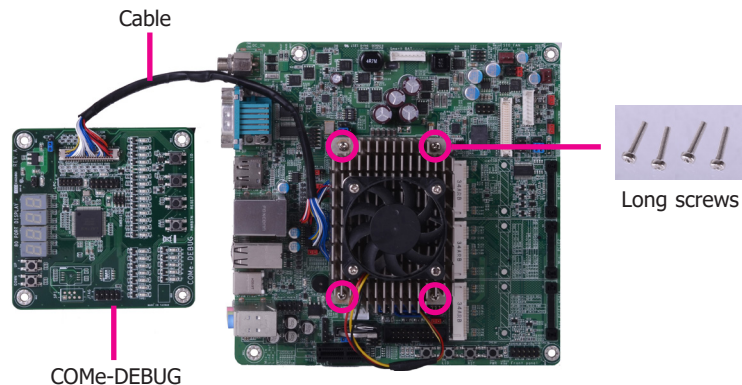

6. Then, grasp the heat sink by its edges and position it down firmly on the top of the COM Express Mini module.

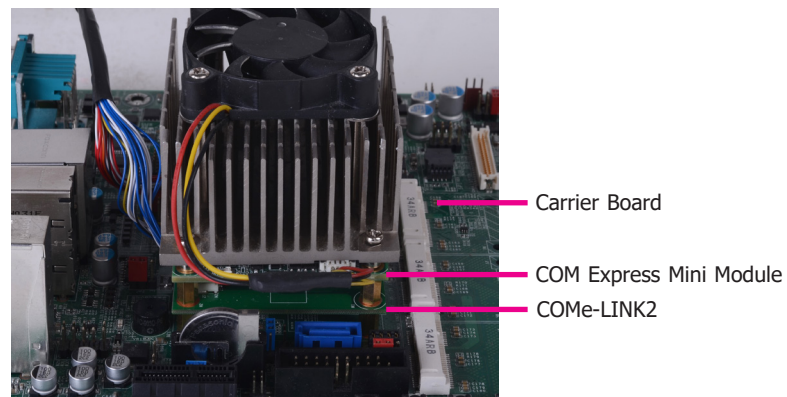
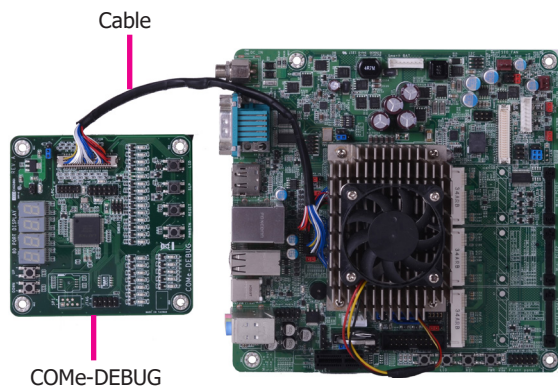

Side View of the Module, Debug Card and Carrier Board

Chapter 4 - BIOS Setup

Overview

The BIOS is a program that takes care of the basic level of communication between the CPU and peripherals. It contains codes for various advanced features found in this system board. The BIOS allows you to configure the system and save the configuration in a battery-backed CMOS so that the data retains even when the power is off. In general, the information stored in the CMOS RAM of the EEPROM will stay unchanged unless a configuration change has been made such as a hard drive replaced or a device added.

It is possible that the CMOS battery will fail causing CMOS data loss. If this happens, you need to install a new CMOS battery and reconfigure the BIOS settings.



Note:

The BIOS is constantly updated to improve the performance of the system board; therefore the BIOS screens in this chapter may not appear the same as the actual one. These screens are for reference purpose only.

Default Configuration

Most of the configuration settings are either predefined according to the Load Optimal Defaults settings which are stored in the BIOS or are automatically detected and configured without requiring any actions. There are a few settings that you may need to change depending on your system configuration.

Entering the BIOS Setup Utility

The BIOS Setup Utility can only be operated from the keyboard and all commands are keyboard commands. The commands are available at the right side of each setup screen.

The BIOS Setup Utility does not require an operating system to run. After you power up the system, the BIOS message appears on the screen and the memory count begins. After the memory test, the message "Press DEL to run setup" will appear on the screen. If the message disappears before you respond, restart the system or press the "Reset" button. You may also restart the system by pressing the <Ctrl> <Alt> and keys simultaneously.

Legends

KEYs	Function
Right and Left Arrows	Moves the highlight left or right to select a menu.
Up and Down Arrows	Moves the highlight up or down between submenus or fields.
<Esc>	Exits to the BIOS setup utility
+ (plus key)	Scrolls forward through the values or options of the highlighted field.
- (minus key)	Scrolls backward through the values or options of the highlighted field.
<F1>	Displays general help
<F2>	Displays previous values
<F3>	Optimized defaults
<F4>	Saves and reset the setup program.
<Enter>	Press <Enter> to enter the highlighted submenu

Scroll Bar

When a scroll bar appears to the right of the setup screen, it indicates that there are more available fields not shown on the screen. Use the up and down arrow keys to scroll through all the available fields.

Submenu

When "►" appears on the left of a particular field, it indicates that a submenu which contains additional options are available for that field. To display the submenu, move the highlight to that field and press <Enter>.

AMI BIOS Setup Utility

Main

The Main menu is the first screen that you will see when you enter the BIOS Setup Utility.

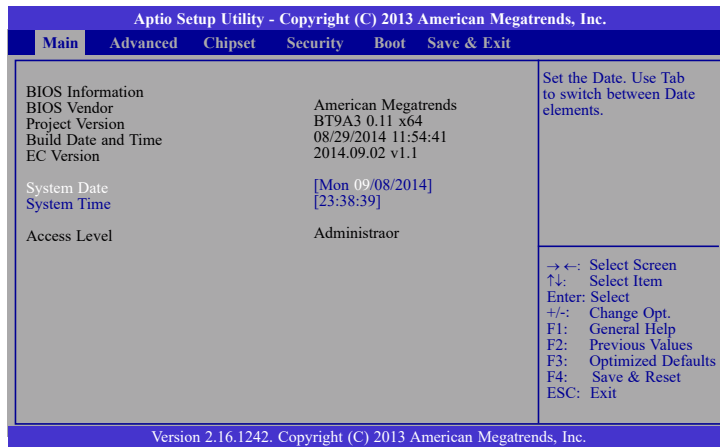

System Date

The date format is <day>, <month>, <date>, <year>. Day displays a day, from Sunday to Saturday. Month displays the month, from January to December. Date displays the date, from 1 to 31. Year displays the year, from 1980 to 2099.

System Time

The time format is <hour>, <minute>, <second>. The time is based on the 24-hour military-time clock. For example, 1 p.m. is 13:00:00. Hour displays hours from 00 to 23. Minute displays minutes from 00 to 59. Second displays seconds from 00 to 59.

Advanced

The Advanced menu allows you to configure your system for basic operation. Some entries are defaults required by the system board, while others, if enabled, will improve the performance of your system or let you set some features according to your preference.



Important:

Setting incorrect field values may cause the system to malfunction.

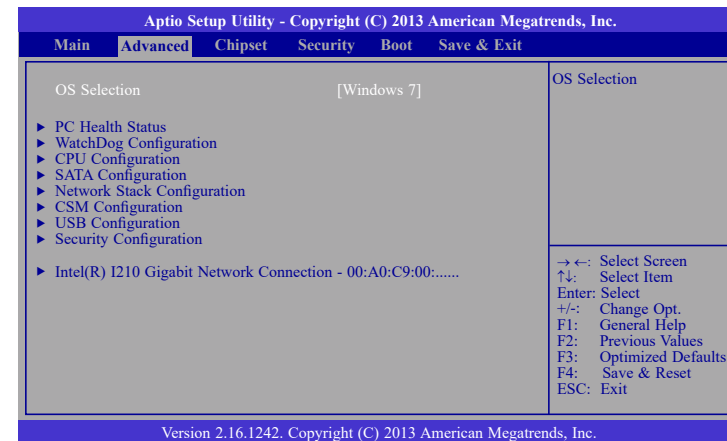

OS Selection

Select the OS support: Windows 7 or Windows 8.X.

PC Health Status

This section displays the hardware health monitor.

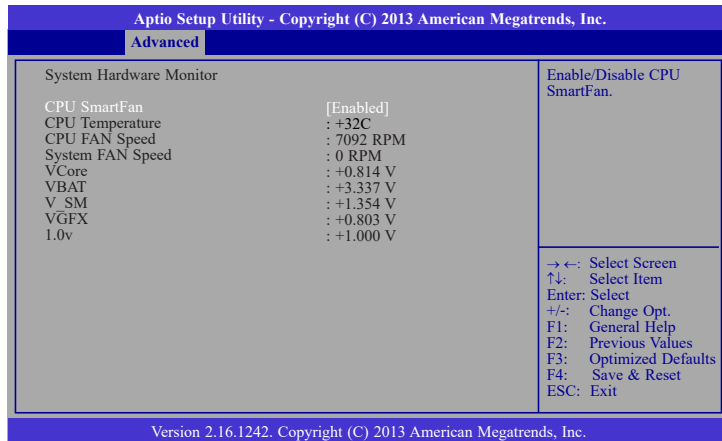

CPU SmartFan

Enable or disable the CPU Smart. When this feature is enabled, the CPU's fan speed will rotate according to the CPU's temperature. The higher the temperature, the faster the speed of rotation.

WatchDog Configuration

This field is used to configure IT8518 WatchDog Timer Parameters.

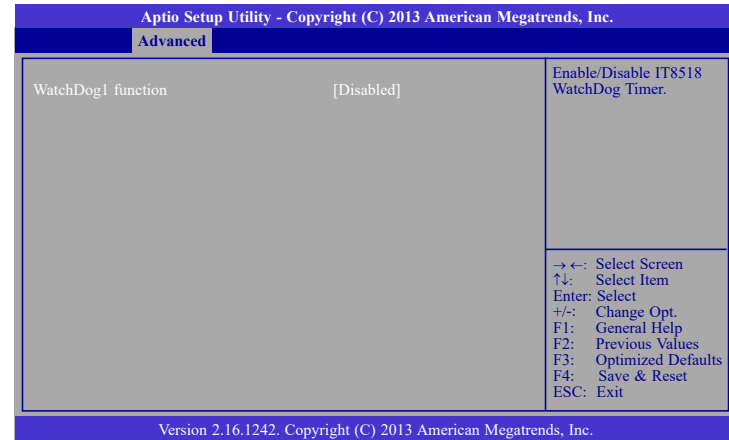

When enabled, it will display the following information:

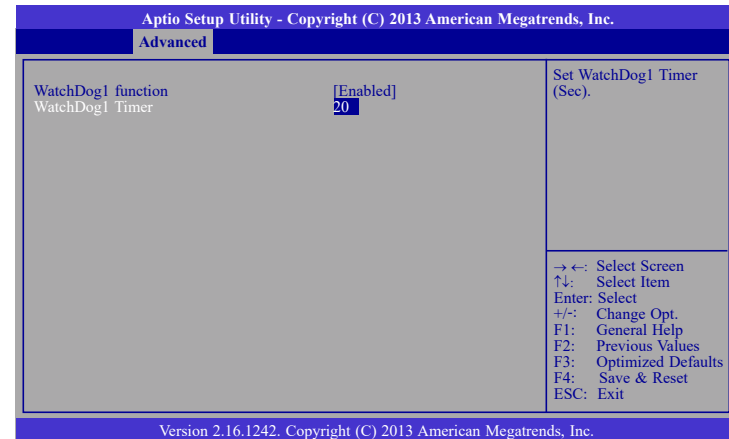

CPU Configuration

This section is used to configure the CPU. It will also display the detection of CPU information.

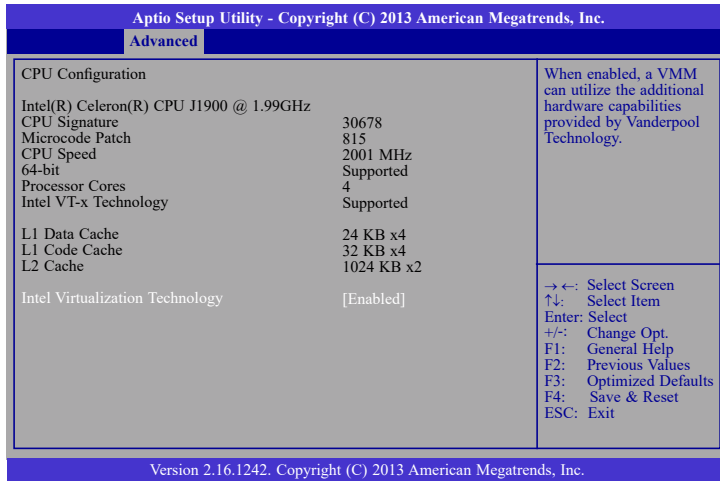

Intel Virtualization Technology

When this field is set to enabled, the VMM can utilize the additional hardware capabilities provided by Vanderpool Technology.

SATA Configuration

This section is used to configure the settings of SATA device.

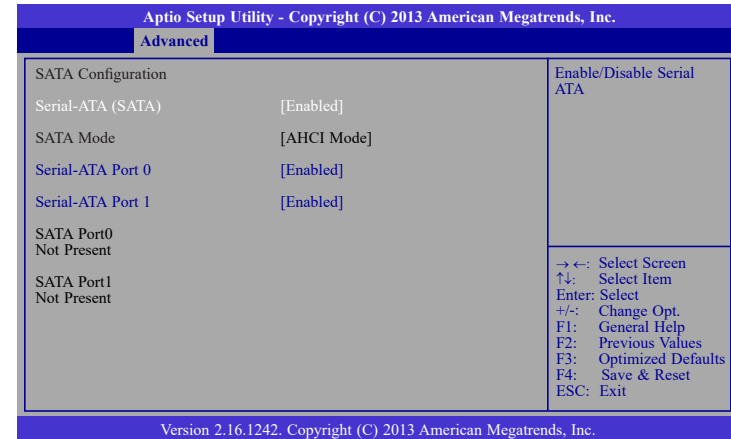

Serial ATA Port 0 and 1

This field is used to enable or disable the Serial ATA port 0 and 1.

Network Stack Configuration

This section is used to enable or disable UEFI network stack.

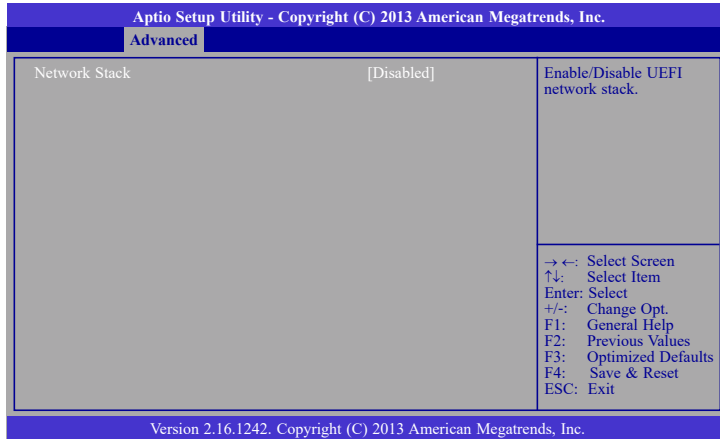

When Network Stack is set to enabled, it will display the following information:

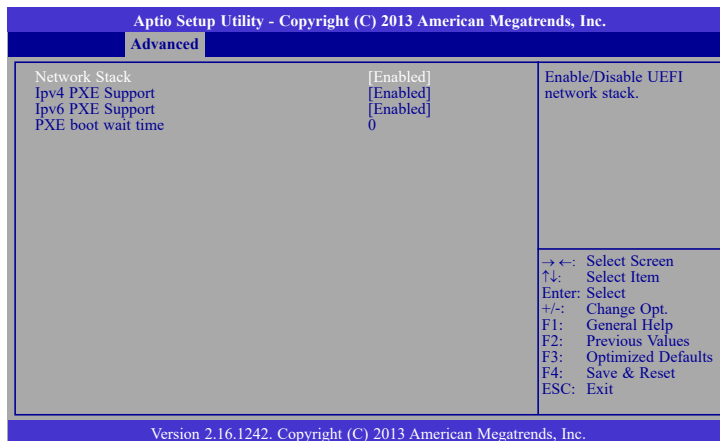

Ipv4 PXE Support

When enabled, Ipv4 PXE boot supports. When disabled, Ipv4 PXE boot option will not be created.

Ipv6 PXE Support

When enabled, Ipv6 PXE boot supports. When disabled, Ipv6 PXE boot option will not be created.

PXE boot wait time

Enter the value of wait time to press <Esc> key to abort the PXE boot.

CSM Configuration

This section configures the CSM settings.

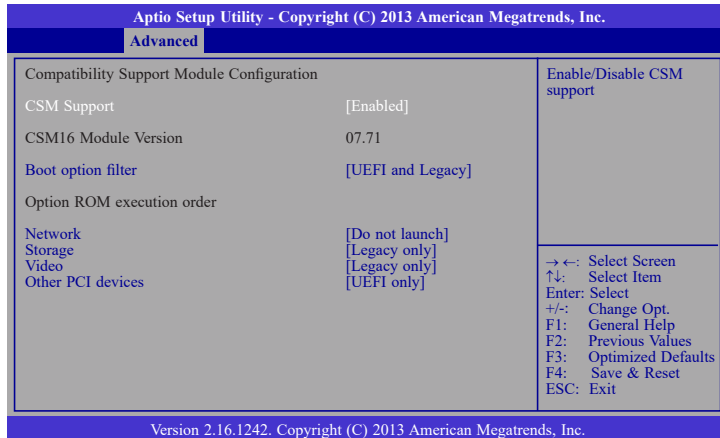

CSM Support

This field is used to enable or disable the CSM support.

Boot option filter

This option controls Legacy/UEFI ROMs priority.

Network

This field controls the execution of UEFI and Legacy PXE OpROM.

Storage

This field controls the execution of UEFI and Legacy Storage OpROM.

Video

This field controls the execution of UEFI and Legacy Video OpROM.

Other PCI devices

This field determines OpROM execution policy for devices other than network, storage or video.

USB Configuration

This section is used to configure parameters of the USB device.

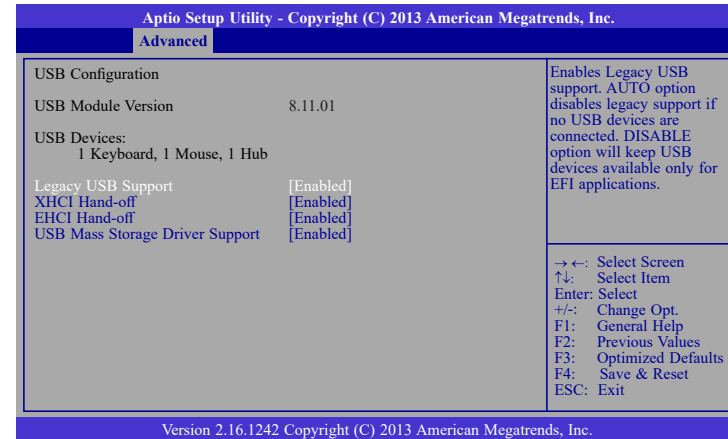

Legacy USB Support

Enabled

Enable legacy USB.

Auto

Disable support for legacy when no USB devices are connected.

Disabled

Keep USB devices available only for EFI applications.

XHCI Hand-off

This is a workaround for OSES without the XHCI hand-off support. The change of XHCI ownership should be claimed by the EHCI driver.

EHCI Hand-off

This is a workaround for OSES without the EHCI hand-off support. The change of EHCI ownership should be claimed by the EHCI driver.

USB Mass Storage Driver Support

Enable or disable the support of the USB Mass Storage Driver.

**Important:**

When installing Windows 7, only native USB 2.0 devices (USB port 0 to USB port 3) can operate under DOS mode. Please refer to the following tables for more information on the type of USB ports.

Table 1. OS Selection

Operation Environment for Customers	DOS	Windows 7	Windows 8.x	Linux
OS Selection in the BIOS Advanced Menu	Windows 8.x	Windows 7	Windows 8.x	Windows 8.x
Available USB ports	All	When installing Windows 7 first time, only native USB 2.0 ports can work. Please refer to the USB type in table 2 below.	All	All

Table 2. The Type of USB Ports

Model Name	BT9A3
USB 3.0	Native
USB 0	Native
USB 1	Native
USB 2	Native
USB 3	Native
USB 4	HSIC port 0
USB 5	HSIC port 1
USB 6	HSIC port 2
USB 7	HSIC port 3

Security Configuration

This section configures the setting relevant to the Intel(R) Anti-Theft Technology.

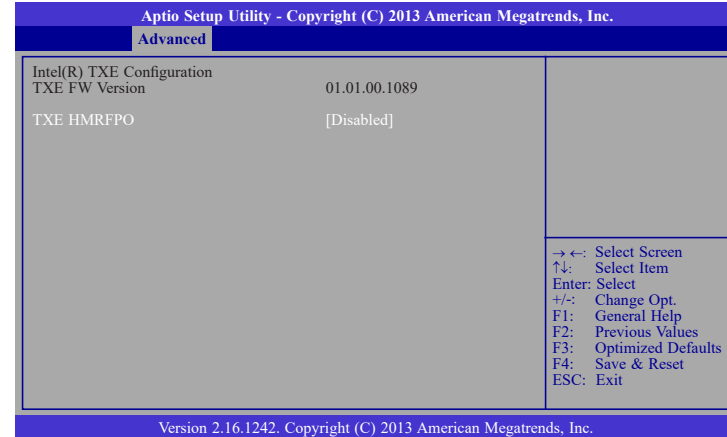

Intel(R) I210 Gigabit Network Connection - 00:A0:C9:00:...

This section is used to configure the parameters of Gigabit Ethernet device.

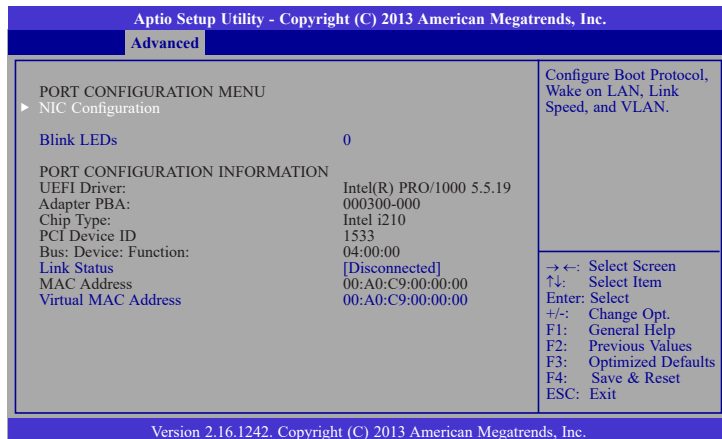

Blink LEDs

Identify the physical network port by blinking the associated LED.

Link Status

This field indicates the link status of the network device.

Virtual MAC Address

This field indicates programmatically assignable MAC address for the network port.

NIC Configuration

This field is used to configure the network device.

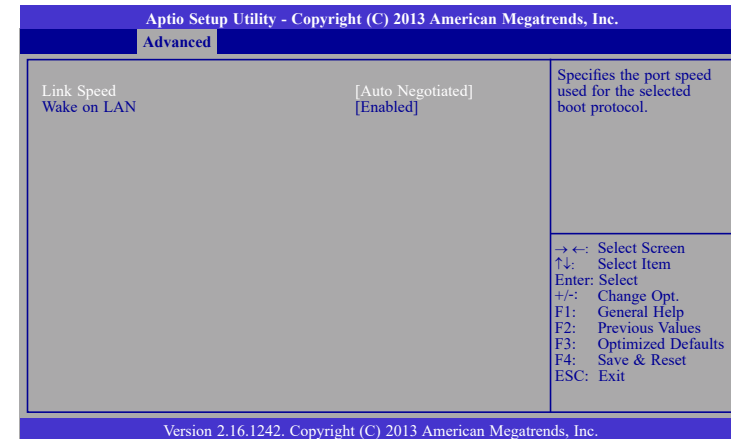

Link Speed

Specify the port speed which is used for the selected boot protocol.

Wake on LAN

Enables the server to be powered on using an in-band magic packet.

Chipset

The section configures the relevant functions of chipset.

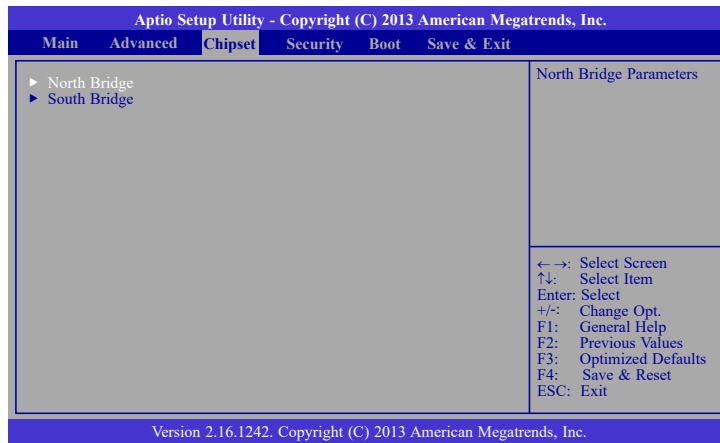

North Bridge

This section configures the North bridge parameters.

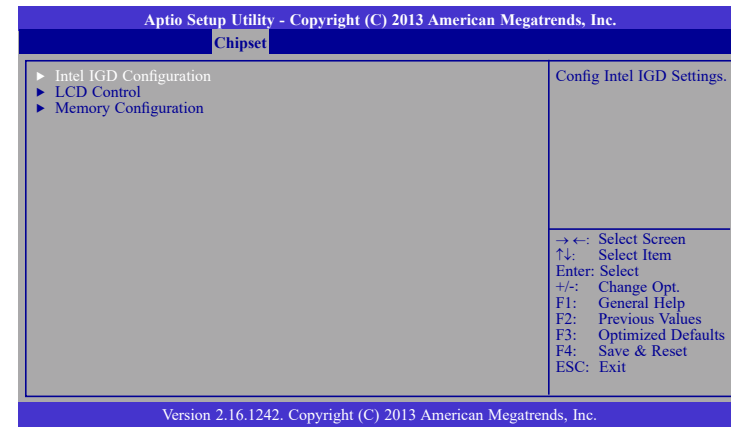

Intel IGD Configuration

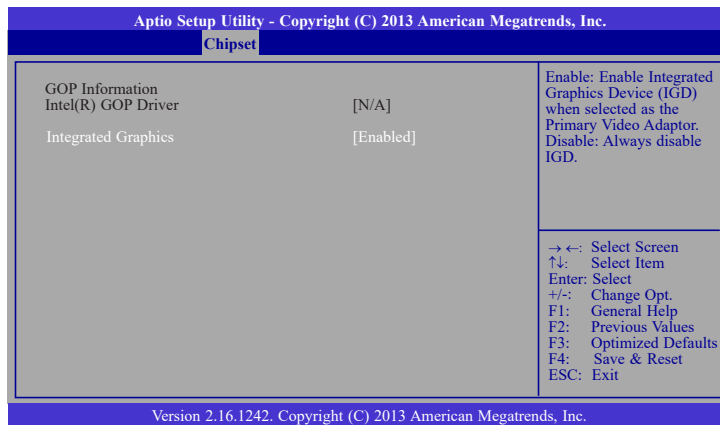

Integrated Graphics

Enable or disable the integrated graphics device (IGD). When enabled, the integrated graphics device is selected as the primary video adaptor.

LCD Control

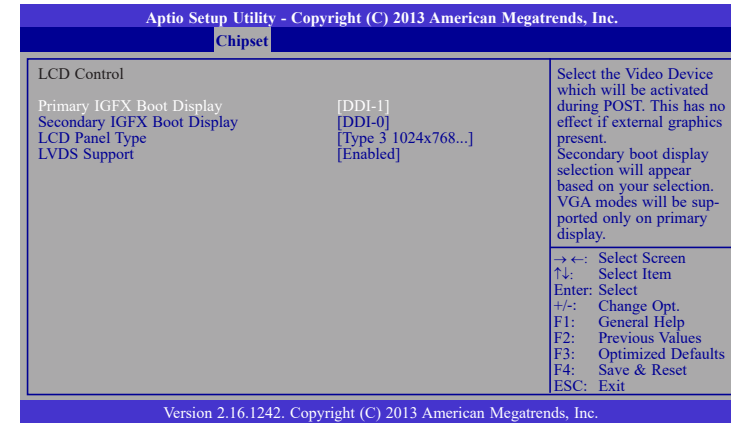

Primary IGFX Boot Display

Select the Video Device which will be activated during POST. This has no effect if the external graphics presents. The selection of secondary boot display will appear based on your selection. VGA modes will be supported only on primary display.

Secondary IGFX Boot Display

Select the secondary display device: DDI-0 or DDI-1. DDI-0 is the default setting.

LCD Panel Type

Select the LCD panel used by Internal Graphics Device by selecting the appropriate setup item. Please refer to the screen shown below.

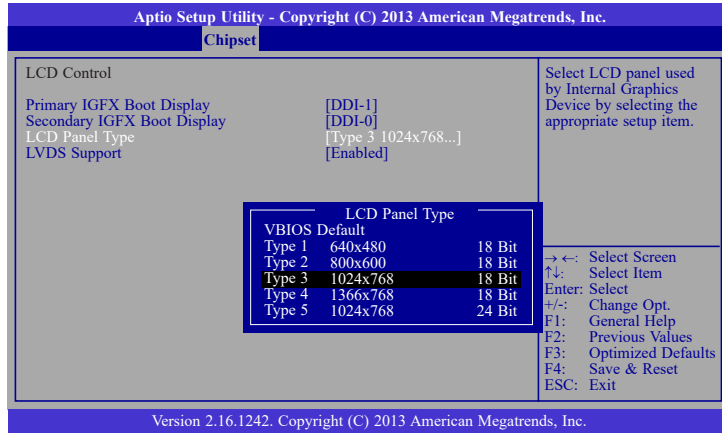

LVDS Support

Enable or disable the onboard LVDS function.

Memory Configuration

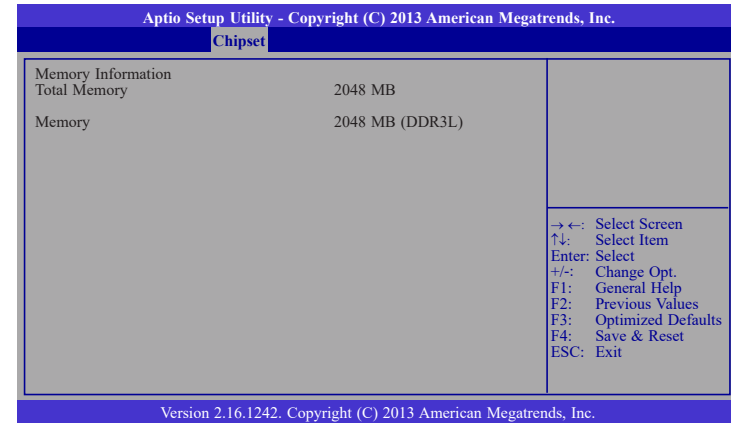

South Bridge

This field is used to configure the parameters of the South Bridge.

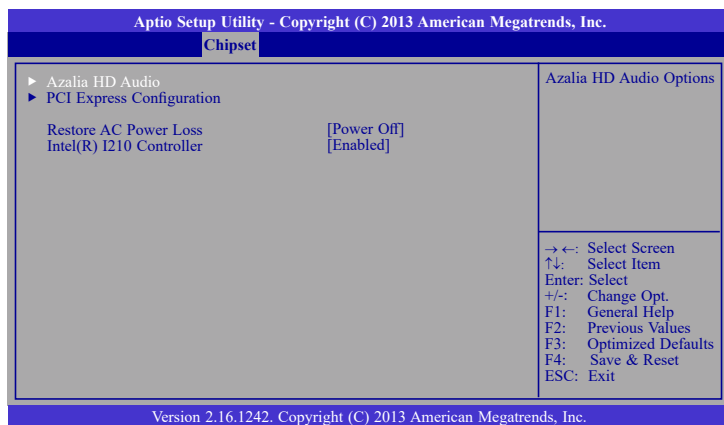

Restore AC Power Loss

Power Off

When power returns after an AC power failure, the system's power is off. You must press the Power button to power-on the system.

Power On

When power returns after an AC power failure, the system will automatically power-on.

Last State

When power returns after an AC power failure, the system will return to the state where you left off before power failure occurs. If the system's power is off when AC power failure occurs, it will remain off when power returns. If the system's power is on when AC power failure occurs, the system will power-on when power returns.

Intel(R) I210 Controller

Enable the Intel(R) I210 ethernet controller.

Azalia HD Audio

This section configures Azalia HD Audio options.

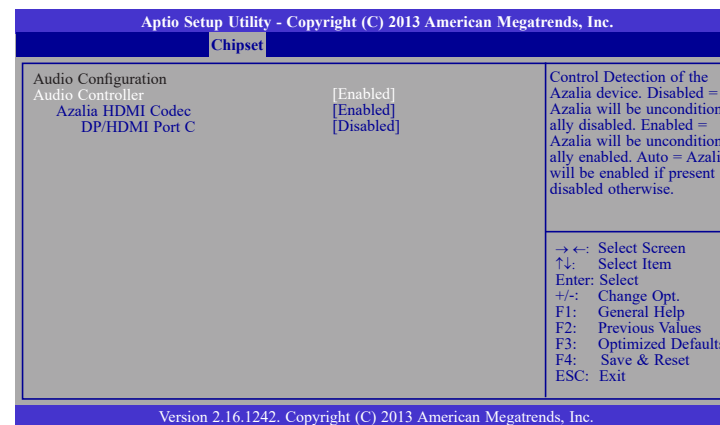

Audio Controller

This item controls the detection of the Azalia device.

Disabled

Azalia will be unconditionally disabled.

Enabled

Azalia will be unconditionally enabled.

Auto

Azalia will be enabled automatically.

Azalia HDMI Codec

Enable or disable the internal HDMI codec for Azalia.

DP/HDMI Port C

Enable or disable the DP/HDMI Port C.

PCI Express Configuration

This section configures settings relevant to PCI Express devices.

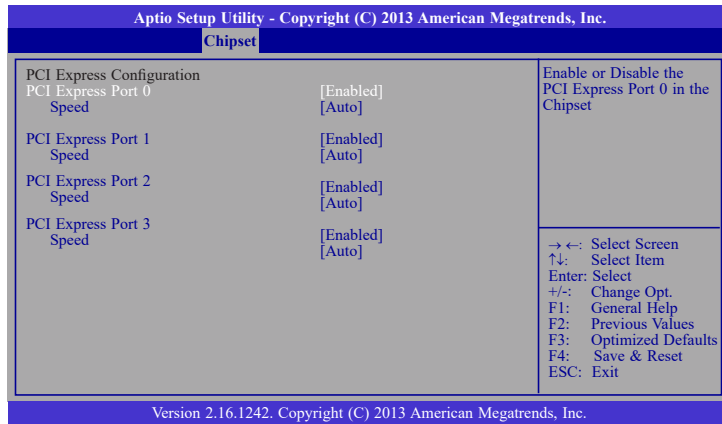

PCI Express Port 0-3

Enable or disable the PCI Express port in the chipset.

Speed

Select the speed for the PCI Express devices. The options are Auto, Gen1 or Gen2.

Security

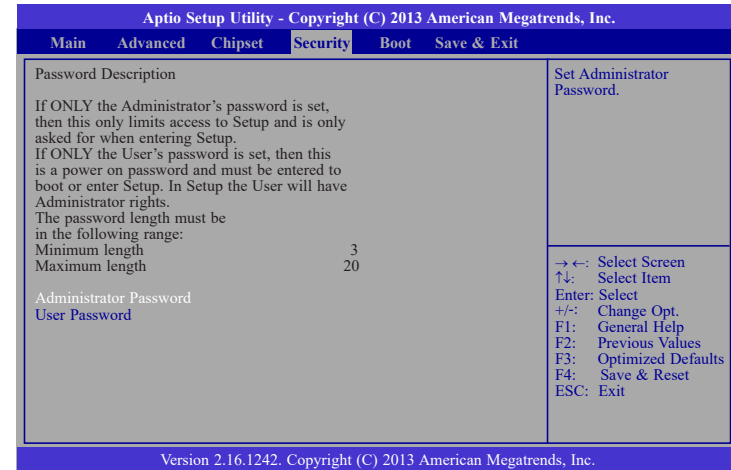

Administrator Password

Set the administrator password.

User Password

Set the user password.

Boot

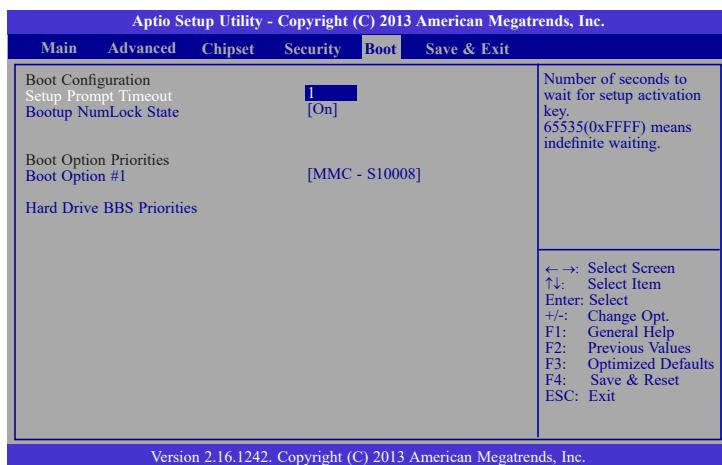

Setup Prompt Timeout

Select the number of seconds to wait for the setup activation key. 65535(0xFFFF) denotes indefinite waiting.

Bootup NumLock State

This allows you to determine the default state of the numeric keypad. By default, the system boots up with NumLock on wherein the function of the numeric keypad is the number keys. When set to Off, the function of the numeric keypad is the arrow keys.

Boot Option #1

Set the system boot order.

Hard Drive BBS Priorities

Set the order of the legacy devices in this group.

Save & Exit

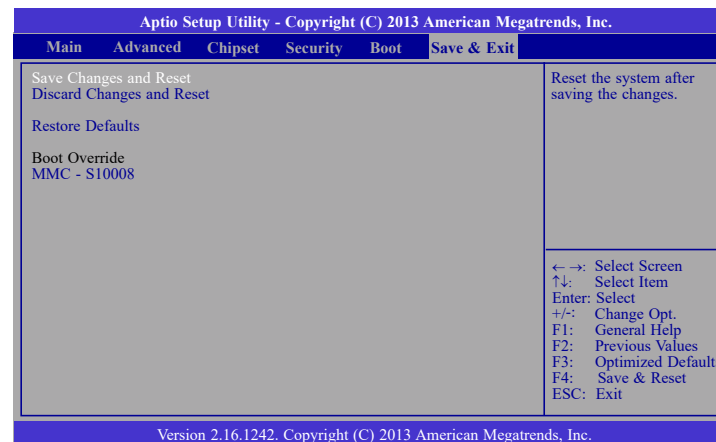

Save Changes and Reset

To save the changes, select this field and then press <Enter>. A dialog box will appear. Select Yes to reset the system after saving all changes made.

Discard Changes and Reset

To discard the changes, select this field and then press <Enter>. A dialog box will appear. Select Yes to reset the system setup without saving any changes.

Restore Defaults

To restore and load the optimized default values, select this field and then press <Enter>. A dialog box will appear. Select Yes to restore the default values of all the setup options.

Updating the BIOS

To update the BIOS, you will need the new BIOS file and a flash utility, AFUDOS.EXE. Please contact technical support or your sales representative for the files.

To execute the utility, type:

A:> AFUDOS BIOS_File_Name /b /p /n
then press <Enter>.

```
C:\AFU\AFUDOS>afudos filename /B /P /N
-----
          AMI Firmware Update Utility(APTIO) v2.25
          Copyright (C)2008 American Megatrends Inc. All Rights Reserved.
-----
Reading file ..... done
Erasing flash ..... done
Writing flash ..... done
Verifying flash ..... done
Erasing BootBlock ..... done
Writing BootBlock ..... done
Verifying BootBlock ..... done

C:\AFU\AFUDOS>
```

After finishing BIOS update, please turn off the AC power. Wait about 10 seconds and then turn on the AC power again.

Notice: BIOS SPI ROM

1. The Intel® Management Engine has already been integrated into this system board. Due to the safety concerns, the BIOS (SPI ROM) chip cannot be removed from this system board and used on another system board of the same model.
2. The BIOS (SPI ROM) on this system board must be the original equipment from the factory and cannot be used to replace one which has been utilized on other system boards.
3. If you do not follow the methods above, the Intel® Management Engine will not be updated and will cease to be effective.



Note:

- a. You can take advantage of flash tools to update the default configuration of the BIOS (SPI ROM) to the latest version anytime.
- b. When the BIOS IC needs to be replaced, you have to populate it properly onto the system board after the EEPROM programmer has been burned and follow the technical person's instructions to confirm that the MAC address should be burned or not.

Chapter 5 - Supported Software

Install drivers, utilities and software applications that are required to facilitate and enhance the performance of the system board. You may acquire the software from your sales representatives, from an optional DVD included in the shipment, or from the website download page at <https://www.dfi.com/DownloadCenter>.

For Windows 8.x

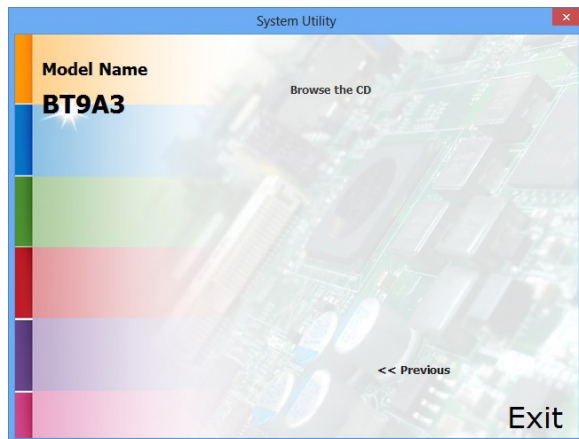
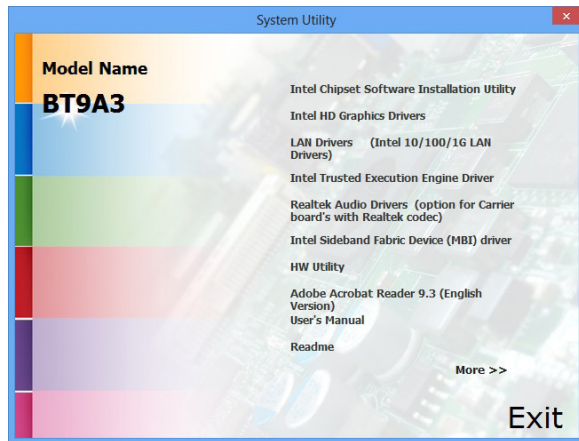

For Windows 7

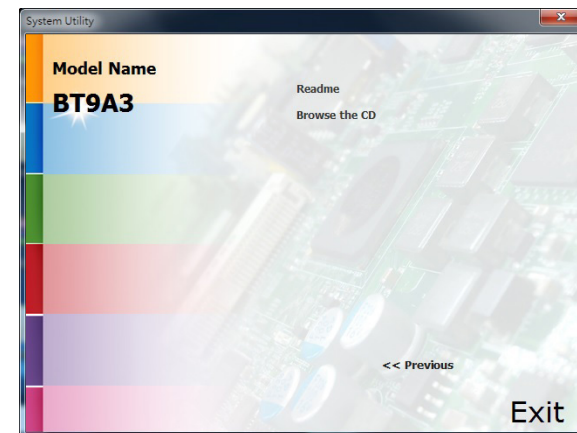
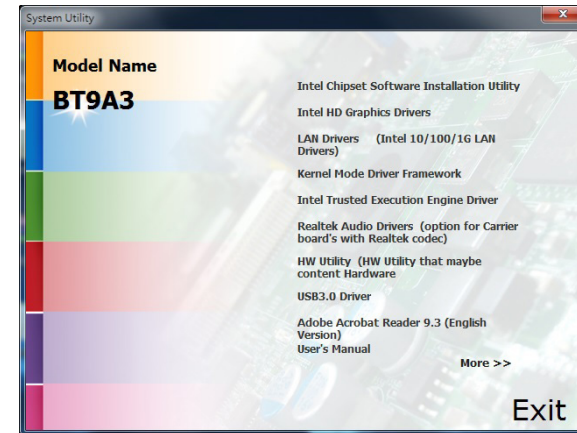

Note:

This step can be ignored if the applications are standalone files.

Intel Chipset Software Installation Utility

The Intel Chipset Device Software is used for updating Windows® INF files so that the Intel chipset can be recognized and configured properly in the system.

To install the utility, click “Intel Chipset Software Installation Utility” on the main menu.

1. Setup is ready to install the utility. Click Next.



2. Read the license agreement then click Yes.



3. Go through the readme document for more installation tips then click Next.



4. After all setup operations are done, click Next.

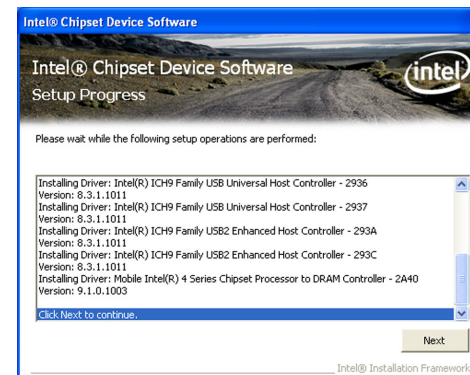

5. Click “Yes, I want to restart this computer now” then click Finish.

Restarting the system will allow the new software installation to take effect.

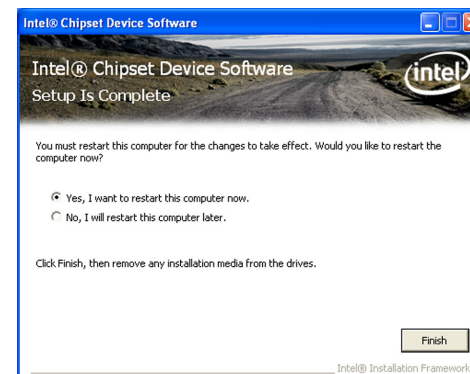

Intel HD Graphics Drivers

To install the driver, click "Intel HD Graphics Drivers" on the main menu.

1. Setup is now ready to install the graphics driver. Click Next.

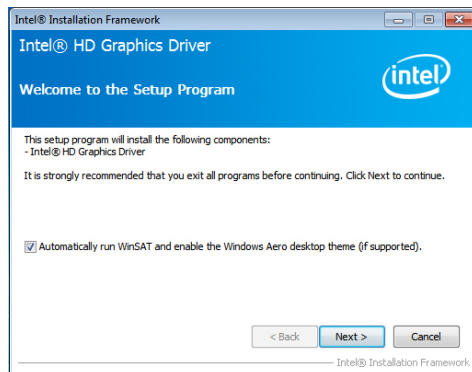

By default, the "Automatically run WinSAT and enable the Windows Aero desktop theme" is enabled. With this enabled, after installing the graphics driver and the system rebooted, the screen will turn blank for 1 to 2 minutes (while WinSAT is running) before the Windows 7/Windows 8 desktop appears. The "blank screen" period is the time Windows is testing the graphics performance.

We recommend that you skip this process by disabling this function then click Next.

2. Read the license agreement then click Yes.



3. Go through the readme document for system requirements and installation tips then click Next.

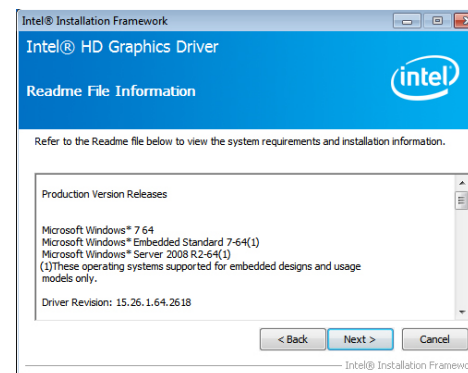

4. Setup is now installing the driver. Click Next to continue.

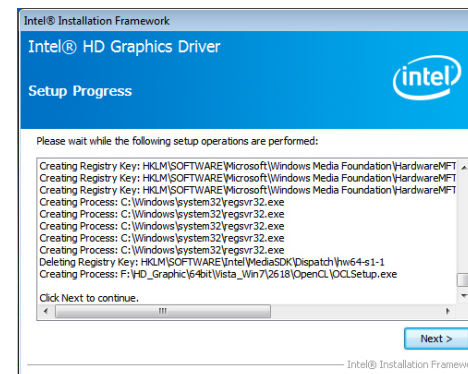

5. Click "Yes, I want to restart this computer now" then click Finish.

Restarting the system will allow the new software installation to take effect.

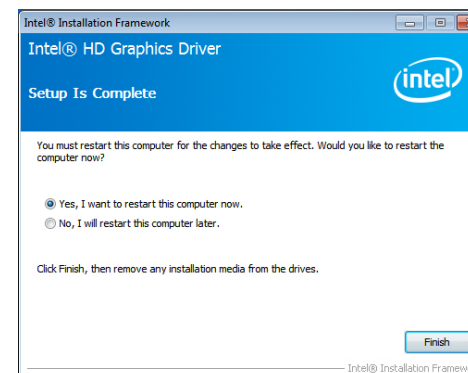

Intel LAN Drivers

To install the driver, click "Intel LAN Drivers" on the main menu.

1. Setup is ready to install the driver. Click Next.



2. Click "I accept the terms in the license agreement" then click "Next".

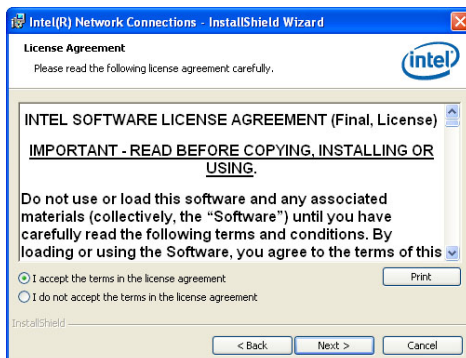

3. Select the program features you want installed then click Next.

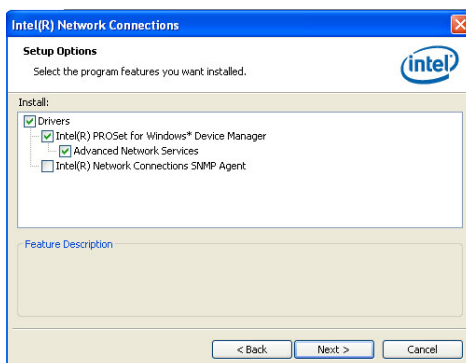

4. Click Install to begin the installation.

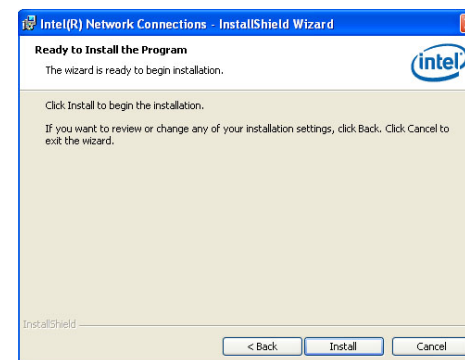

5. After completing installation, click Finish.

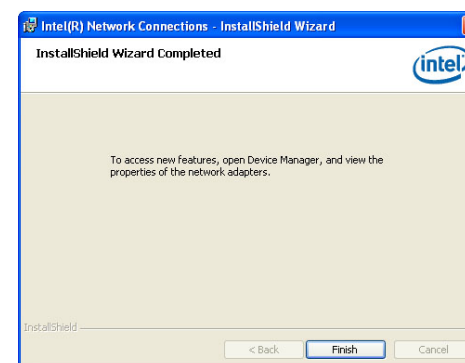

Kernel Mode Driver Framework (For Windows 7 only)

To install the driver, click "Kernel Mode Driver Framework" on the main menu.

1. Click "Yes" to install the update.

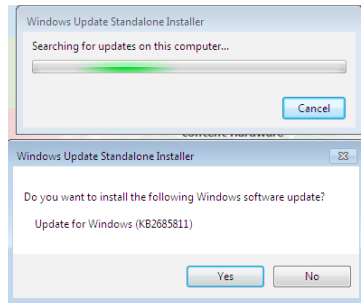

2. The update is installed now.

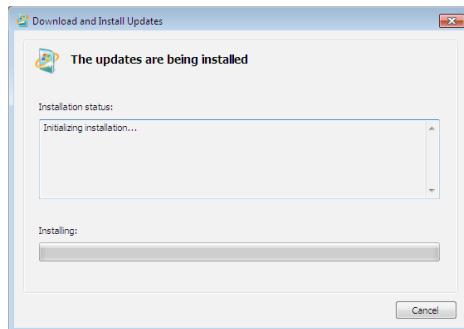

3. Click "Restart Now" to restart your computer when the installation is complete.

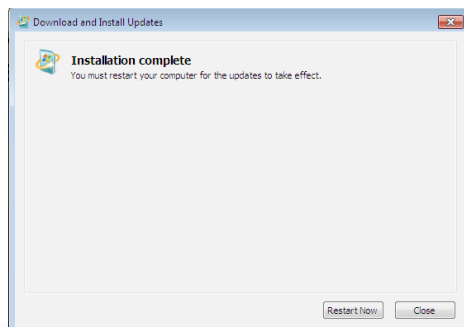

Intel Trusted Execution Engine Driver

To install the driver, click "Intel Trusted Execution Engine Driver" on the main menu.

1. Tick "I accept the terms in the License Agreement" and then click "Next."

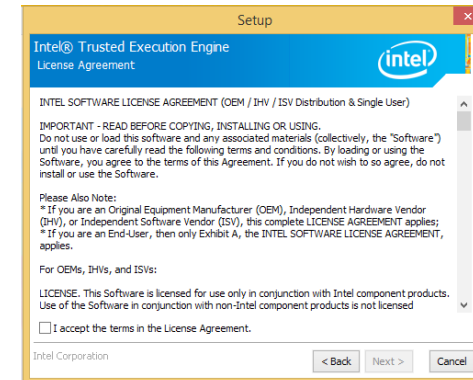

2. The step shows the components which will be installed. Then, Click Next.

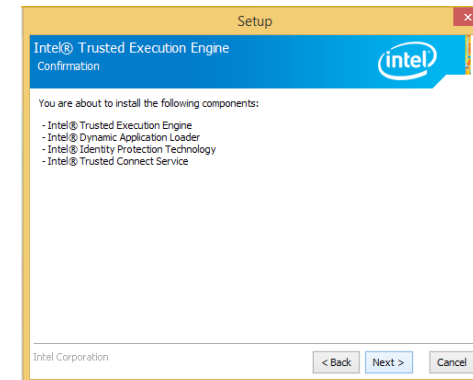

3. The step displays the installing status in the progress.

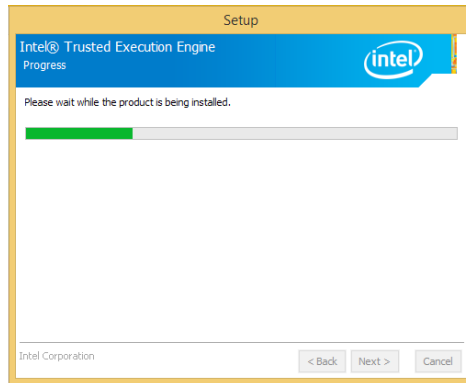

4. Click "Finish" when the installation is complete.

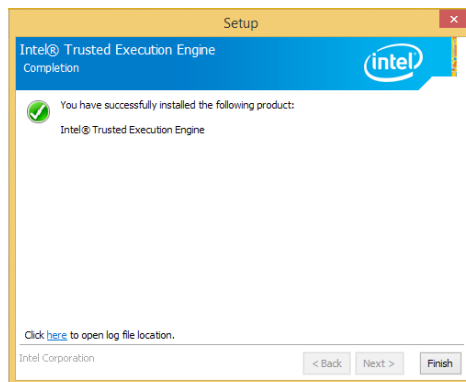

Realtek Audio Drivers

To install the driver, click "Realtek Audio Drivers" on the main menu.

1. Setup is now ready to install the audio driver. Click Next.
2. Follow the remainder of the steps on the screen; clicking "Next" each time you finish a step.

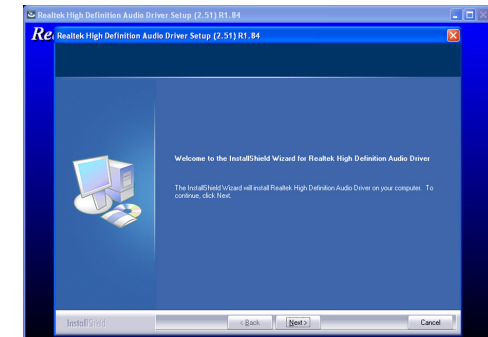

3. Click "Yes, I want to restart my computer now" then click Finish.

Restarting the system will allow the new software installation to take effect.

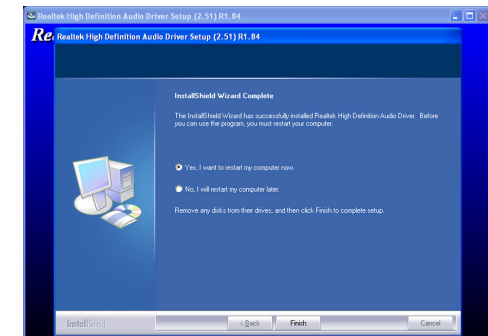

Intel Sideband Fabric Device (MBI) Driver (For Windows 8 only)

To install the driver, click "Intel Sideband Fabric Device (MBI) Driver" on the main menu.

1. The setup program will be installed. Click "Next" to continue.

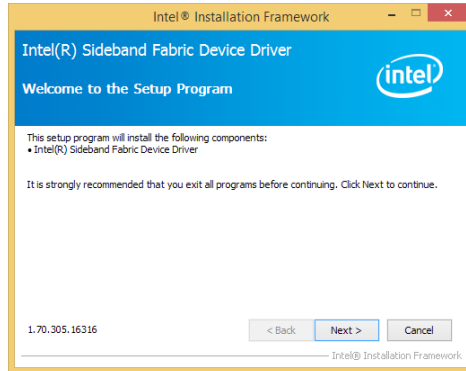

2. Click "Yes" to accept the License Agreement.

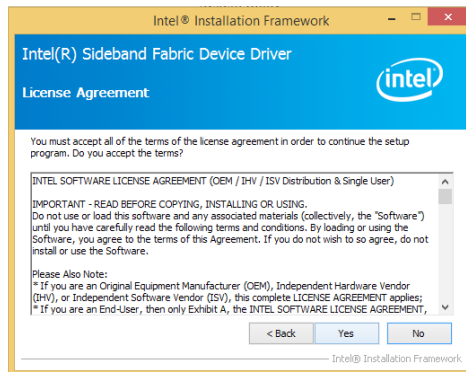

3. The step performs setup operations. Click "Next" to continue.

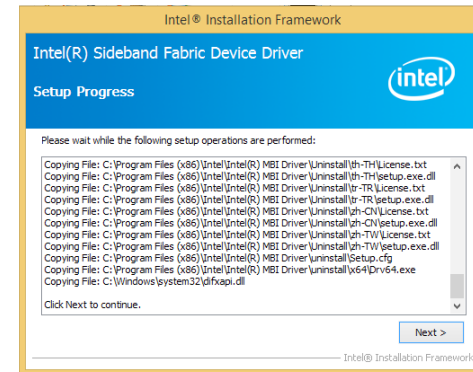

4. Click "Finish" to restart the computer when the setup is completely installed.

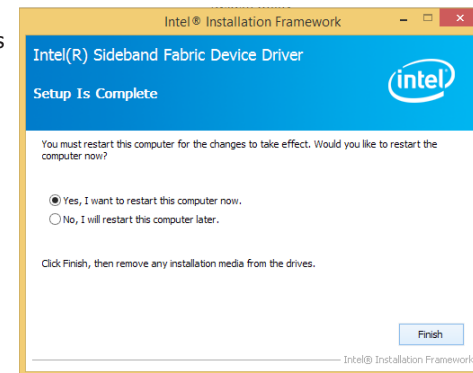

HW Utility

DFI Utility provides information about the board, HW Health, Watchdog, DIO, and Backlight. To access the utility, click "DFI Utility" on the main menu.



Note:

If you are using Windows 7, you need to access the operating system as an administrator to be able to install the utility.

1. Setup is ready to install the DFI Utility driver. Click Next.



2. Click "I accept the terms in the license agreement" and then click Next.

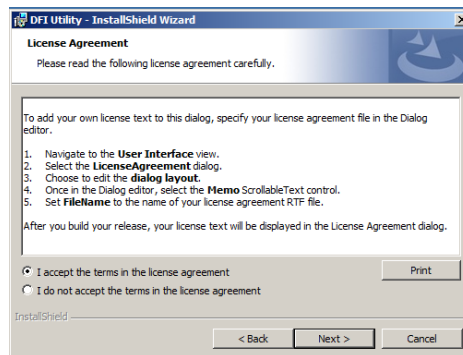

3. Enter "User Name" and "Organization" information and then click Next.

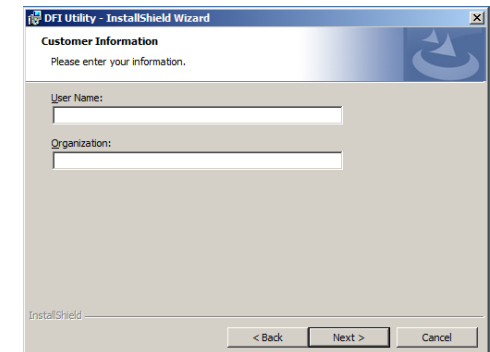

4. Click Install to begin the installation.

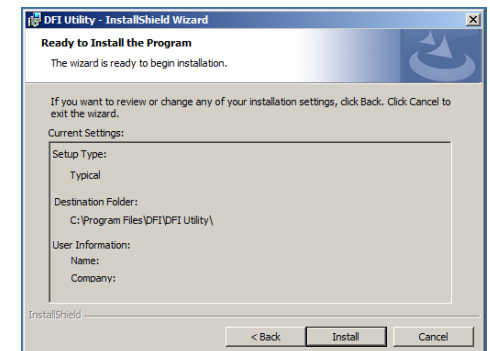

5. After completing installation, click Finish.

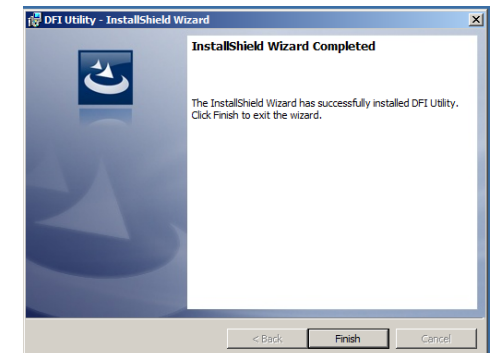

The DFI Utility icon will appear on the desktop. Double-click the icon to open the utility.



Information

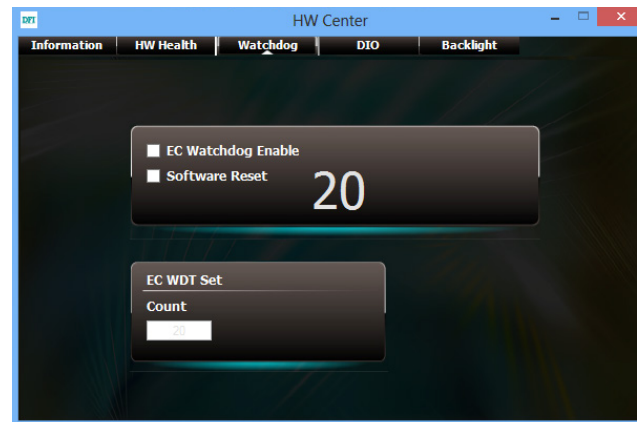

WatchDog



HW Health

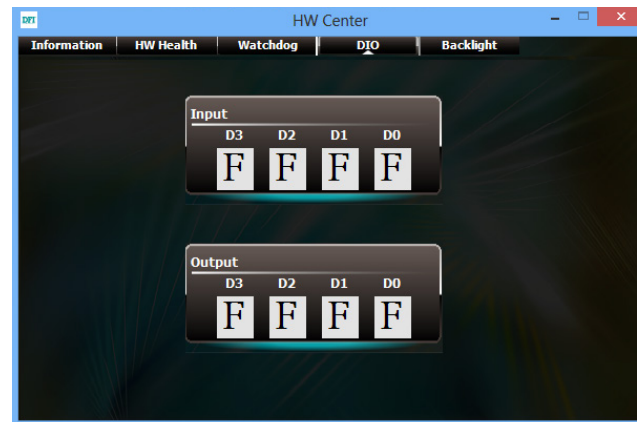

DIO

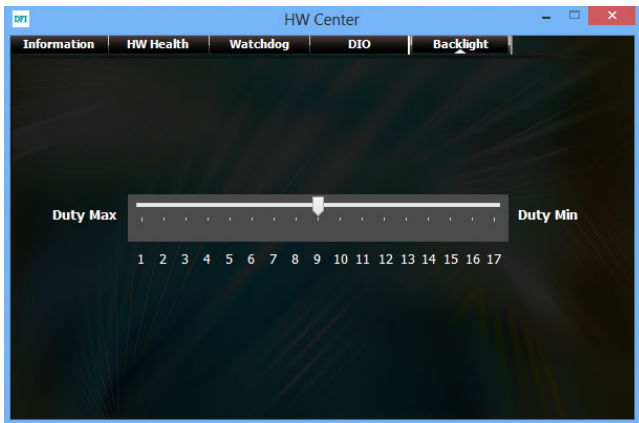

Backlight

Intel USB 3.0 Drivers (For Windows 7 Only)

To install the driver, click "Intel USB 3.0 Driver" on the main menu.

1. Setup is ready to install the driver. Click Next.

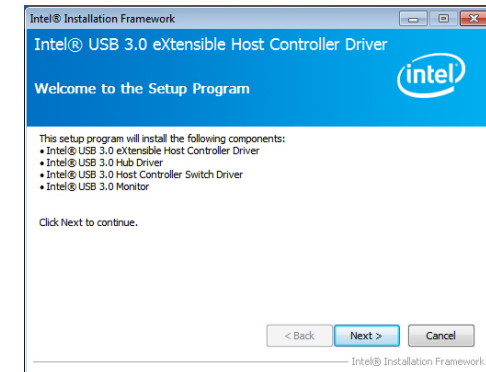

2. Read the license agreement then click Yes.

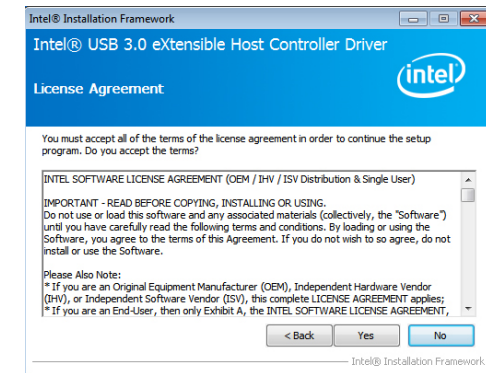

Chapter 6 - GPIO Programming Guide

Function Description

Get_EC_Data (unsigned char ucData): Read a Byte data from EC.

Write_EC_Data (unsigned char ucData, unsigned char Data): Write a Byte data to EC.

Sample Code

GPIO Input Process

```
EC_DIO_Read_Input()
{
    BYTE Data;

    //Pin0-3 Input Mode
    Data = Get_EC_Data(0xBA);
    Data |= 0x80;
    Write_EC_Data(0xBA, Data);
    while(((Get_EC_Data(0xBA) >> 7)&0x01))
    {
        Data = Get_EC_Data(0xBA);
    }

    Return Data ;
}
```

GPIO Output Process

```
EC_DIO_Write_Output(unsigned char udata)
{
    //Pin4-7 Output Mode
    udata <<= 4;
    udata |= 0x01;
    Write_EC_Data(0xBB, udata);

    return 0;
}

EC_DIO_Read_Output()
{
    BYTE Data;

    //Pin4-7 Output Mode
    Write_EC_Data(0xBB, 0x02);
    Delay;
    Data = Get_EC_Data(0xBB);
    Data >>= 4;
    Return Data ;
}
```

Appendix A - Watchdog Sample Code

```
#include <stdio.h>
//-----
#define EC_EnablePort 0x66
#define EC_DataPort 0x62
//-----
void WriteEC(char,int);
void SetWdTime(int,int);
int GetWdTime(void);
//-----
main()
{
    unsigned int countdown;
    unsigned int input,count_h,count_l;

    printf("Input WD Time: ");
    scanf("%d",&input);
    printf("\n");
    count_h=input>>8;
    count_l=input&0x00FF;
    SetWdTime(count_h,count_l);

    while(1)
    {
        countdown = GetWdTime();
        delay(100);
        printf("\rTime Remaining: %d ",countdown);
    }
}
//-----
void SetWdTime(int count_H,int count_L)
{
    //Set Count
    WriteEC(0xB5,count_H); //High Byte
    WriteEC(0xB6,count_L); //Low Byte
    //Enable Watch Dog Timer
    WriteEC(0xB4,0x01);
}
//-----
```

```
int GetWdTime(void)
{
    int sum,data_h,data_l;
    //Select EC Read Type
    outportb(EC_EnablePort,0x80);
    delay(5);
    //Get Remaining Count High Byte
    outportb(EC_DataPort,0xF4);
    delay(5);
    data_h=inportb(EC_DataPort);
    delay(5);
    //Select EC Read Type
    outportb(EC_EnablePort,0x80);
    delay(5);
    //Get Remaining Count Low Byte
    outportb(EC_DataPort,0xF5);
    delay(5);
    data_l=inportb(EC_DataPort);
    delay(5);

    data_h<=8;
    data_h&=0xFF00;
    sum=data_h|data_l;
    return sum;
}
//-----
void WriteEC(char EC_Addr, int data)
{
    //Select EC Write Type
    outportb(EC_EnablePort,0x81);
    delay(5);
    outportb(EC_DataPort,EC_Addr);
    delay(5);
    outportb(EC_DataPort,data);
    delay(5);
}
//-----
```

Appendix B - System Error Message

When the BIOS encounters an error that requires the user to correct something, either a beep code will sound or a message will be displayed in a box in the middle of the screen and the message, PRESS F1 TO CONTINUE, CTRL-ALT-ESC or DEL TO ENTER SETUP, will be shown in the information box at the bottom. Enter Setup to correct the error.

Error Messages

One or more of the following messages may be displayed if the BIOS detects an error during the POST. This list indicates the error messages for all Awards BIOSes:

CMOS BATTERY HAS FAILED

The CMOS battery is no longer functional. It should be replaced.



Important:

Danger of explosion if battery incorrectly replaced. Replace only with the same or equivalent type recommended by the manufacturer. Dispose of used batteries according to the battery manufacturer's instructions.

CMOS CHECKSUM ERROR

Checksum of CMOS is incorrect. This can indicate that CMOS has become corrupt. This error may have been caused by a weak battery. Check the battery and replace if necessary.

DISPLAY SWITCH IS SET INCORRECTLY

The display switch on the motherboard can be set to either monochrome or color. This indicates the switch is set to a different setting than indicated in Setup. Determine which setting is correct, either turn off the system and change the jumper or enter Setup and change the VIDEO selection.

Standard Status Codes

PEI Status Codes

0x11	Pre-memory CPU initialization is started
0x15	Pre-memory North Bridge initialization is started
0x19	Pre-memory South Bridge initialization is started
0x2A	OEM pre-memory initialization codes
0x2B	Memory initialization. Serial Presence Detect (SPD) data reading
0x2C	Memory initialization. Memory presence detection
0x2D	Memory initialization. Programming memory timing information
0x2E	Memory initialization. Configuring memory
0x2F	Memory initialization (other).

PEI Error Codes

0x50	Memory initialization error. Invalid memory type or incompatible memory speed
0x51	Memory initialization error. SPD reading has failed
0x52	Memory initialization error. Invalid memory size or memory modules do not match.
0x53	Memory initialization error. No usable memory detected

DXE Phase Codes

0x92	PCI Bus initialization is started
0x93	PCI Bus Hot Plug Controller Initialization
0x94	PCI Bus Enumeration
0x95	PCI Bus Request Resources
0x96	PCI Bus Assign Resources
0x99	Super IO Initialization
0x9A	USB initialization is started
0x9B	USB Reset
0x9C	USB Detect
0x9D	USB Enable
0xA0	IDE initialization is started
0xA1	IDE Reset
0xA2	IDE Detect
0xA3	IDE Enable
0xAE	Legacy Boot event
0xB4	USB hot plug
0xB6	Clean-up of NVRAM
0xB7	Configuration Reset (reset of NVRAM settings)

DXE Error Codes

0xD6	No Console Output Devices are found
0xD7	No Console Input Devices are found
0xD8	Invalid password

ACPI Checkpoints

0x03	System is entering S3 sleep state
0x04	System is entering S4 sleep state
0x05	System is entering S5 sleep state
0x30	System is waking up from the S3 sleep state
0x40	System is waking up from the S4 sleep state
0xAC	System has transitioned into ACPI mode. Interrupt controller is in PIC mode.
0xAA	System has transitioned into ACPI mode. Interrupt controller is in APIC mode.

Beep Code

6 beeps	Flash update is failed
---------	------------------------

Appendix C - Troubleshooting

Troubleshooting Checklist

This chapter of the manual is designed to help you with problems that you may encounter with your personal computer. To efficiently troubleshoot your system, treat each problem individually. This is to ensure an accurate diagnosis of the problem in case a problem has multiple causes.

Some of the most common things to check when you encounter problems while using your system are listed below.

1. The power switch of each peripheral device is turned on.
2. All cables and power cords are tightly connected.
3. The electrical outlet to which your peripheral devices are connected is working. Test the outlet by plugging in a lamp or other electrical device.
4. The monitor is turned on.
5. The display's brightness and contrast controls are adjusted properly.
6. All add-in boards in the expansion slots are seated securely.
7. Any add-in board you have installed is designed for your system and is set up correctly.

Monitor/Display

If the display screen remains dark after the system is turned on:

1. Make sure that the monitor's power switch is on.
2. Check that one end of the monitor's power cord is properly attached to the monitor and the other end is plugged into a working AC outlet. If necessary, try another outlet.
3. Check that the video input cable is properly attached to the monitor and the system's display adapter.
4. Adjust the brightness of the display by turning the monitor's brightness control knob.

The picture seems to be constantly moving.

1. The monitor has lost its vertical sync. Adjust the monitor's vertical sync.
2. Move away any objects, such as another monitor or fan, that may be creating a magnetic field around the display.
3. Make sure your video card's output frequencies are supported by this monitor.

The screen seems to be constantly wavering.

1. If the monitor is close to another monitor, the adjacent monitor may need to be turned off. Fluorescent lights adjacent to the monitor may also cause screen wavering.

Power Supply

When the computer is turned on, nothing happens.

1. Check that one end of the AC power cord is plugged into a live outlet and the other end properly plugged into the back of the system.
2. Make sure that the voltage selection switch on the back panel is set for the correct type of voltage you are using.
3. The power cord may have a "short" or "open". Inspect the cord and install a new one if necessary.

Hard Drive

Hard disk failure.

1. Make sure the correct drive type for the hard disk drive has been entered in the BIOS.
2. If the system is configured with two hard drives, make sure the bootable (first) hard drive is configured as Master and the second hard drive is configured as Slave. The master hard drive must have an active/bootable partition.

Excessively long formatting period.

If your hard drive takes an excessively long period of time to format, it is likely a cable connection problem. However, if your hard drive has a large capacity, it will take a longer time to format.

Serial Port

The serial device (modem, printer) doesn't output anything or is outputting garbled characters.

1. Make sure that the serial device's power is turned on and that the device is on-line.
2. Verify that the device is plugged into the correct serial port on the rear of the computer.
3. Verify that the attached serial device works by attaching it to a serial port that is working and configured correctly. If the serial device does not work, either the cable or the serial device has a problem. If the serial device works, the problem may be due to the onboard I/O or the address setting.
4. Make sure the COM settings and I/O address are configured correctly.

Keyboard

Nothing happens when a key on the keyboard was pressed.

1. Make sure the keyboard is properly connected.
2. Make sure there are no objects resting on the keyboard and that no keys are pressed during the booting process.

System Board

1. Make sure the add-in card is seated securely in the expansion slot. If the add-in card is loose, power off the system, re-install the card and power up the system.
2. Check the jumper settings to ensure that the jumpers are properly set.
3. Verify that all memory modules are seated securely into the memory sockets.
4. Make sure the memory modules are in the correct locations.
5. If the board fails to function, place the board on a flat surface and seat all socketed components. Gently press each component into the socket.
6. If you made changes to the BIOS settings, re-enter setup and load the BIOS defaults.