



WL051

2.5" Pico-ITX Motherboard User's Manual

Copyright

This publication contains information that is protected by copyright. No part of it may be reproduced in any form or by any means or used to make any transformation/adaptation without the prior written permission from the copyright holders.

This publication is provided for informational purposes only. The manufacturer makes no representations or warranties with respect to the contents or use of this manual and specifically disclaims any express or implied warranties of merchantability or fitness for any particular purpose. The user will assume the entire risk of the use or the results of the use of this document. Further, the manufacturer reserves the right to revise this publication and make changes to its contents at any time, without obligation to notify any person or entity of such revisions or changes.

Changes after the publication's first release will be based on the product's revision. The website will always provide the most updated information.

© 2020. All Rights Reserved.

Trademarks

Product names or trademarks appearing in this manual are for identification purpose only and are the properties of the respective owners.

FCC and DOC Statement on Class B

This equipment has been tested and found to comply with the limits for a Class B digital device, pursuant to Part 15 of the FCC rules. These limits are designed to provide reasonable protection against harmful interference when the equipment is operated in a residential installation. This equipment generates, uses and can radiate radio frequency energy and, if not installed and used in accordance with the instruction manual, may cause harmful interference to radio communications. However, there is no guarantee that interference will not occur in a particular installation. If this equipment does cause harmful interference to radio or television reception, which can be determined by turning the equipment off and on, the user is encouraged to try to correct the interference by one or more of the following measures:

- Reorient or relocate the receiving antenna.
- Increase the separation between the equipment and the receiver.
- Connect the equipment into an outlet on a circuit different from that to which the receiver is connected.
- Consult the dealer or an experienced radio TV technician for help.

Notice:

1. The changes or modifications not expressly approved by the party responsible for compliance could void the user's authority to operate the equipment.
2. Shielded interface cables must be used in order to comply with the emission limits.

Table of Contents

Chapter 1 - Introduction	6
Specifications	6
WL051.....	6
Features	7
Chapter 2 - Hardware Installation	8
Board Layout.....	8
System Memory	9
Installing the Memory Module.....	9
Removing the Memory Module.....	10
Installing the Heat Sink.....	11
Jumper Settings	12
Clear CMOS.....	12
Rear I/O Ports.....	13
USB Ports.....	13
Graphics Display.....	14
LAN.....	14
Graphics Display.....	15
Internal I/O Connectors	16
SMBus	16
USB Ports.....	17
Front Audio.....	18
Digital I/O.....	18
Power Connector.....	19
Front Panel.....	20
Battery Header.....	21
Chapter 3 - BIOS Settings	22
Overview	22
Main.....	23
Advanced	23
RC ACPI Configuration.....	24
CPU Configuration.....	24
Power & Performance.....	25
PCH-FW Configuration.....	25
Trusted Computing.....	28
NCT5525D Super IO Configuration.....	28
NCT5525D HW Monitor.....	29
Serial Port Console Redirection.....	30
USB Configuration.....	31
CSM Configuration.....	31
USB Power Control.....	32
Network Stack Configuration.....	32

Chipset	33
Graphics Configuration	33
PCH-IO Configuration.....	34
PCI Express Configuration.....	34
SATA And RST Configuration	35
HD Audio Configuration	35
Security	36
Secure Boot.....	36
Boot	38
Save & Exit	38
Updating the BIOS.....	39
Notice: BIOS SPI ROM.....	39
Chapter 4 - Intel AMT Settings	40
Overview	40
Enable Intel® AMT in the AMI BIOS	40
Entering Management Engine BIOS Extension (MEBX)	41
MEBX.....	42
Main Menu	42
Intel(R) ME General Settings	42
Intel(R) Standard Manageability.....	44

About this Manual

This manual can be downloaded from the website.

The manual is subject to change and update without notice, and may be based on editions that do not resemble your actual products. Please visit our website or contact our sales representatives for the latest editions.

Warranty

1. Warranty does not cover damages or failures that arise from misuse of the product, inability to use the product, unauthorized replacement or alteration of components and product specifications.
2. The warranty is void if the product has been subjected to physical abuse, improper installation, modification, accidents or unauthorized repair of the product.
3. Unless otherwise instructed in this user's manual, the user may not, under any circumstances, attempt to perform service, adjustments or repairs on the product, whether in or out of warranty. It must be returned to the purchase point, factory or authorized service agency for all such work.
4. We will not be liable for any indirect, special, incidental or consequential damages to the product that has been modified or altered.

Static Electricity Precautions

It is quite easy to inadvertently damage your PC, system board, components or devices even before installing them in your system unit. Static electrical discharge can damage computer components without causing any signs of physical damage. You must take extra care in handling them to ensure against electrostatic build-up.

1. To prevent electrostatic build-up, leave the system board in its anti-static bag until you are ready to install it.
2. Wear an antistatic wrist strap.
3. Do all preparation work on a static-free surface.
4. Hold the device only by its edges. Be careful not to touch any of the components, contacts or connections.
5. Avoid touching the pins or contacts on all modules and connectors. Hold modules or connectors by their ends.



Important:

Electrostatic discharge (ESD) can damage your processor, disk drive and other components. Perform the upgrade instruction procedures described at an ESD workstation only. If such a station is not available, you can provide some ESD protection by wearing an antistatic wrist strap and attaching it to a metal part of the system chassis. If a wrist strap is unavailable, establish and maintain contact with the system chassis throughout any procedures requiring ESD protection.

Safety Measures

- To avoid damage to the system, use the correct AC input voltage range.
- To reduce the risk of electric shock, unplug the power cord before removing the system chassis cover for installation or servicing. After installation or servicing, cover the system chassis before plugging the power cord.

About the Package

The package contains the following items. If any of these items are missing or damaged, please contact your dealer or sales representative for assistance.

- 1 WL051 board
- 1 Heat spreader (Height: 11mm) A71-808331-000G

Note: The items are subject to change in the developing stage.

The board and accessories in the package may not come similar to the information listed above. This may differ in accordance with the sales region or models in which it was sold. For more information about the standard package in your region, please contact your dealer or sales representative.

Before Using the System Board

When installing the system board in a new system, you will need at least the following internal components.

- Memory module
- Storage device
- Power adaptor

External system peripherals may also be required for navigation and display, including at least a keyboard, a mouse and a video display monitor.

Chapter 1 - Introduction

► Specifications

WL051

SYSTEM	Processor	8th Generation Intel® Core™ Processors, BGA 1528 Intel® Core™ i7-8665UE, Quad Core, 8M Cache, 1.7GHz (4.4GHz), 15W Intel® Core™ i5-8365UE, Quad Core, 6M Cache, 1.6GHz (4.1GHz), 15W Intel® Core™ i3-8145UE, Dual Core, 4M Cache, 2.2GHz (3.9GHz), 15W Intel® Core™ Celeron® 4305UE, Dual Core, 2M Cache, 2.0GHz (2.0GHz), 15W
	Memory	One 260-pin SODIMM up to 32GB Single Channel DDR4 up to 2400MHz
	BIOS	AMI SPI 128Mbit
	GRAPHICS	Controller Intel® UHD Graphics 620/ Intel® UHD Graphics 610 (for Celeron 4305UE) Feature OpenGL 4.5, DirectX 12, OpenCL 2.1 HW Decode: AVC/H.264, MPEG2, VC1/WMV9, JPEG/MJPEG, HEVC/H265, VP8, VP9 HW Encode: AVC/H.264, MPEG2, JPEG, HEVC/H265, VP8, VP9
	Display	1 x DP++/HDMI 1 x eDP DP++: resolution up to 4096x2304 @ 60Hz HDMI: resolution up to 4096x2160 @30Hz eDP: resolution up to 4096x2304 @ 60Hz
	Dual Displays	DP++ / HDMI + eDP
EXPANSION	Interface	1 x M.2 E key 2230 (PCIe x2/USB 2.0) 2 x M.2 B key 3042/2242 (PCIe x1 or SATA 3.0/USB 3.1 Gen1/USB 2.0)
AUDIO	Audio Codec	Realtek ALC888S-VD2-GR
ETHERNET	Controller	1 x Intel® I219V/I219LM (only Core i7/i5 supports iAMT) 1 x Intel® I210IT
REAR I/O	Ethernet	2 x GbE (RJ-45)
	USB	2 x USB 3.1 Gen 2
	Display	1 x DP++ / HDMI 1 x eDP
INTERNAL I/O	Serial	1 x RS-232/422/485 (1.27mm pitch)
	USB	2 x USB 2.0 (1.27mm pitch)
	Display	1 x eDP Connector
	Audio	1 x Audio (Line-out/Mic-in)
	DIO	1 x 8-bit DIO
	SMBus	1 x SMBus
WATCHDOG	Output & Interval	System Reset, Programmable via Software from 1 to 255 sec/min

SECURITY	TPM	fTPM2.0
POWER	Type	Single 12V +/-10% DC
	Connector	2-pin Terminal Block
	RTC Battery	CR2032 Coin Cell
	Consumption	TBD
OS SUPPORT (UEFI Only)		Windows 10 IoT Enterprise 64-bit Linux
ENVIRONMENT	Temperature	Operating: -5 to 65°C, -30 to 80°C Storage: -40 to 85°C
	Humidity	Operating: 5 to 90% RH Storage: 5 to 90% RH
	MTBF	TBD
MECHANICAL	Dimensions	2.5" Pico-ITX Form Factor 100mm (3.94") x 72mm (2.83")
	Height	PCB: 1.6mm Top Side; 15mm, Bottom Side: 8mm
CERTIFICATIONS		CE, FCC, RoHS

► Features

Watchdog Timer

The Watchdog Timer function allows your application to regularly “clear” the system at the set time interval. If the system hangs or fails to function, it will reset at the set time interval so that your system will continue to operate.

DDR4

DDR4 delivers increased system bandwidth and improves performance. The advantages of DDR4 provide an extended battery life and improve the performance at a lower power than DDR3/DDR2.

Graphics

The integrated Intel® HD graphics engine delivers an excellent blend of graphics performance and features to meet business needs. It provides excellent video and 3D graphics with outstanding graphics responsiveness. These enhancements deliver the performance and compatibility needed for today's and tomorrow's business applications.

Gigabit LAN

The Gigabit Ethernet Controllers support data transmission at 1Gbps.

Audio

The audio codec provides 5.1 channel High Definition audio output.

Wake-On-LAN

This feature allows the network to remotely wake up a Soft Power Down (Soft-Off) PC. It is supported via the onboard LAN port or via a PCI LAN card that uses the PCI PME (Power Management Event) signal. However, if your system is in the Suspend mode, you can power-on the system only through an IRQ or DMA interrupt.

Wake-On-USB

This function allows you to use a USB keyboard or USB mouse to wake up a system from the S3 (STR - Suspend To RAM) state.

ACPI STR

The system board is designed to meet the ACPI (Advanced Configuration and Power Interface) specification. ACPI has energy saving features that enables PCs to implement Power Management and Plug-and-Play with operating systems that support OS Direct Power Management. ACPI when enabled in the Power Management Setup will allow you to use the Suspend to RAM function.

With the Suspend to RAM function enabled, you can power-off the system at once by pressing the power button or selecting “Standby” when you shut down Windows® without having to go through the sometimes tiresome process of closing files, applications and operating system. This is because the system is capable of storing all programs and data files during the entire operating session into RAM (Random Access Memory) when it powers-off. The operating session will resume exactly where you left off the next time you power-on the system.

Power Failure Recovery

When power returns after an AC power failure, you may choose to either power-on the system manually or let the system power-on automatically.

USB

The system board supports the new USB 3.1 Gen 2. It is capable of running at a maximum transmission speed of up to 10 Gbit/s (1.2 GB/s) and is faster than USB 3.1 Gen 1 (5 Gbit/s, or 625 MB/s), USB 2.0 (480 Mbit/s, or 60 MB/s) and USB 1.1 (12Mb/s). USB 3.1 reduces the time required for data transmission, reduces power consumption, and is backward compatible with USB 2.0. It is a marked improvement in device transfer speeds between your computer and a wide range of simultaneously accessible external Plug and Play peripherals.

RTC Timer

The Real Time Clock (RTC) installed on the system board allows your system to automatically power-on on the set date and time.

Chapter 2 - Hardware Installation

▶ Board Layout

Top View

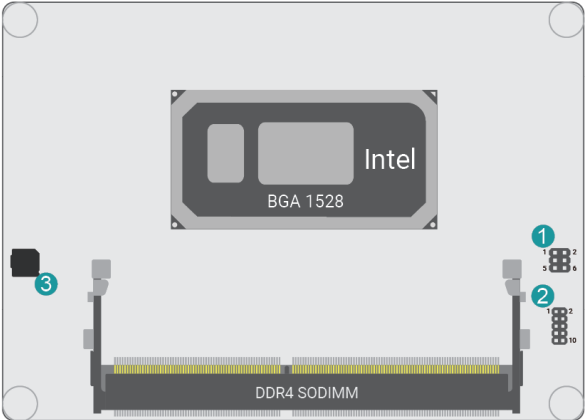

Bottom View

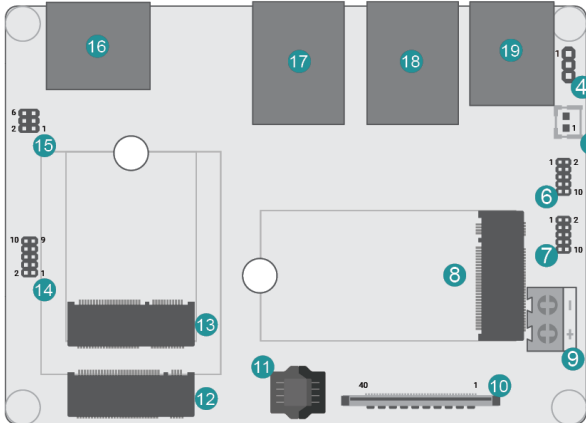

- 1 SMBus
- 2 Front Audio
- 3 Buzzer
- 4 JP1
- 5 Battery
- 6 USB 6/7 (USB 2.0)
- 7 DIO
- 8 M.2 B Key 3042
- 9 12VDC-In
- 10 eDP
- 11 SPI Flash BIOS
- 12 M.2 B Key 3042
- 13 M.2 E Key 2230
- 14 COM1
- 15 Front Panel
- 16 DP/DP++/HDMI
- 17 LAN2
- 18 LAN1
- 19 2 x USB 3.1 Gen2



Note:
Some components are optional and only available upon request.



Important:
Electrostatic discharge (ESD) can damage your board, processor, disk drives, add-in boards, and other components. Perform installation procedures at an ESD workstation only. If such a station is not available, you can provide some ESD protection by wearing an antistatic wrist strap and attaching it to a metal part of the system chassis. If a wrist strap is unavailable, establish and maintain contact with the system chassis throughout any procedures requiring ESD protection.

► **System Memory**

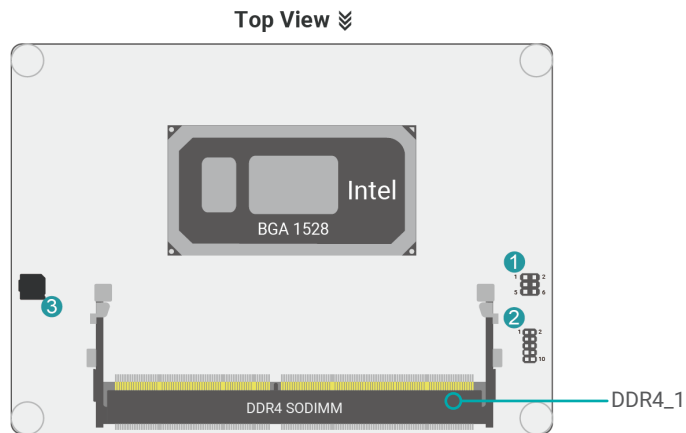

The system board supports the following memory interface.

► **System Memory**

Installing the Memory Module

Before installing the memory module, please make sure that the following safety cautions are well-attended.

1. Make sure the PC and all other peripheral devices connected to it has been powered down.
2. Disconnect all power cords and cables.
3. Locate the socket on the system board
4. Make sure the notch on memory card is aligned to the key on the socket.

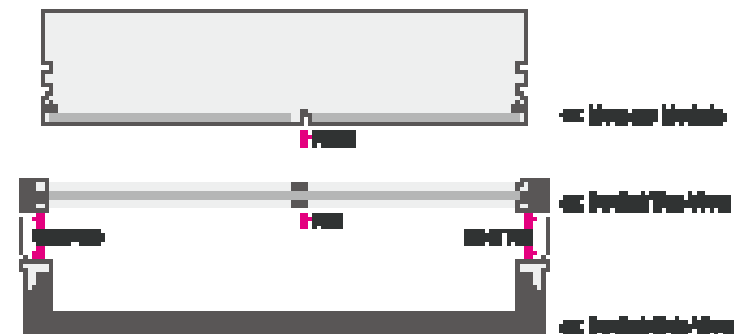

► System Memory ► Installing the Memory Module

Please follow the steps below to install the memory card into the socket.

Step 1:

Press the eject tabs at both ends of the socket outward and downward to release them from the locked position.

Step 2:

Insert the memory card into the slot while making sure the notch and the key are aligned. Press the card down firmly with fingers while applying and maintaining even pressure on both ends.

Step 3:

The tabs snap automatically to the edges of the card and lock the card in place.

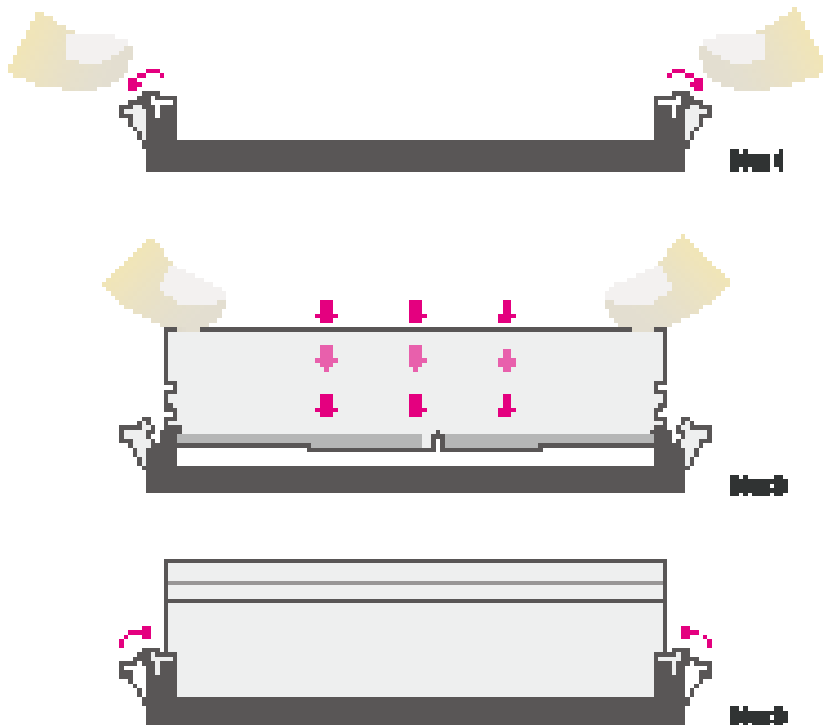

► System Memory

Removing the Memory Module

Please follow the steps below to remove the memory card from the socket.

Step 1:

Press the eject tabs at both ends of the socket outward and downward to release them from the locked position.

Step 2:

The memory card ejects from the slot automatically.

Step 3:

Hold the card by its edges and remove it from the slot.

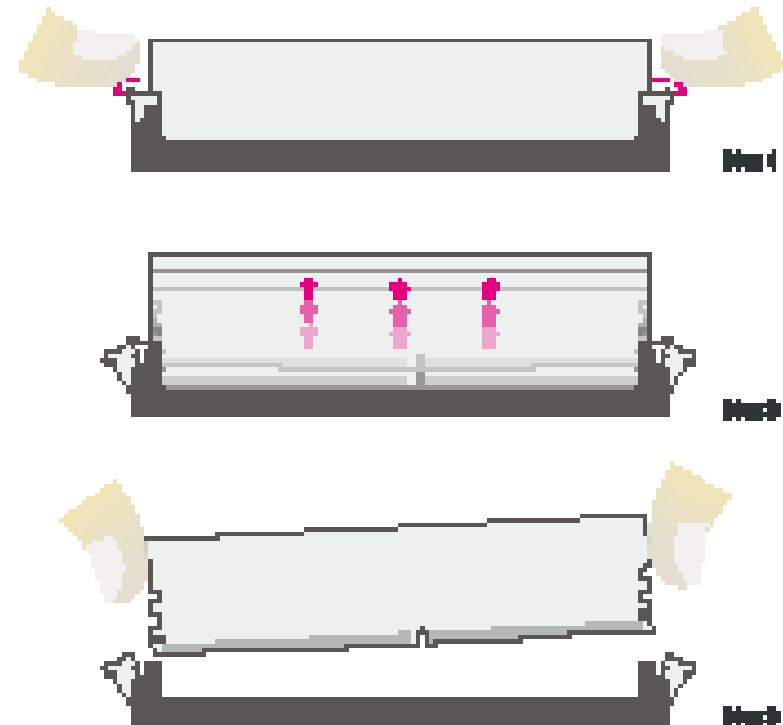

▶ CPU

Installing the Heat Sink

The CPU must be kept cool by using a heat sink, otherwise the CPU will overheat damaging both the CPU and system board.

1. Before you install the fan / heat sink, you must apply a thermal paste onto the top of the CPU. The thermal paste is usually supplied when you purchase the fan / heat sink assembly. Do not spread the paste all over the surface. When you later place the heat sink on top of the CPU, the compound will disperse evenly.

Some heat sinks come with a patch of pre-applied thermal paste. Do not apply thermal paste if the fan / heat sink already has a patch of thermal paste on its underside. Peel the strip that covers the paste before you place the fan / heat sink on top of the CPU.

2. Place the heat sink on top of the CPU. The 4 spring screws around the heat sink, which are used to secure the heat sink onto the system board, must match the 4 mounting holes around the board.
3. Screw tight two of the spring screws at opposite corners into the mounting holes. And then proceed with the other two spring screws.

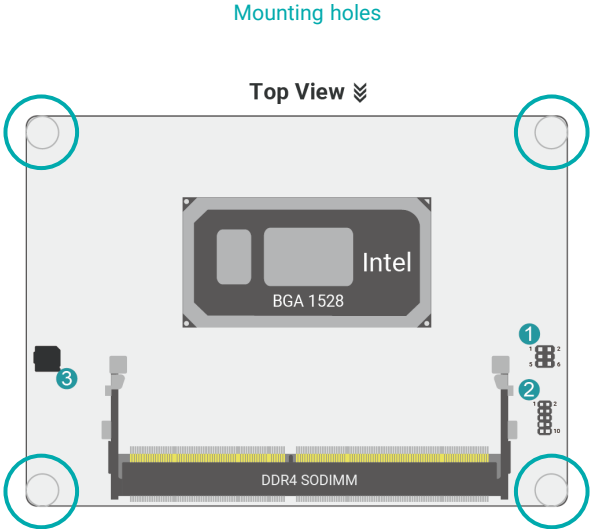

A heat spreader is included in the standard package. The heat spreader and components required for mounting are illustrated below.

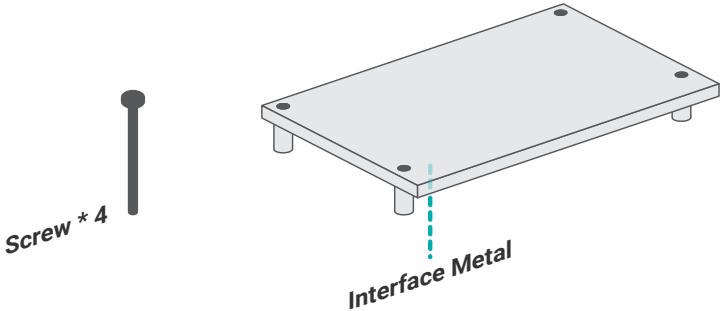

The heat spreader is designed to be mounted onto the module as illustrated below. Please make sure the contacting sides of the heat spreader and the module are correct – the CPU side of the module shall be facing the interface metal side and legs of the heat spreader. Rotate horizontally so the interface metal sits right on top of the CPU. Remove any plastic cover on the interface metal and apply thermal paste/adhesive if it is required.

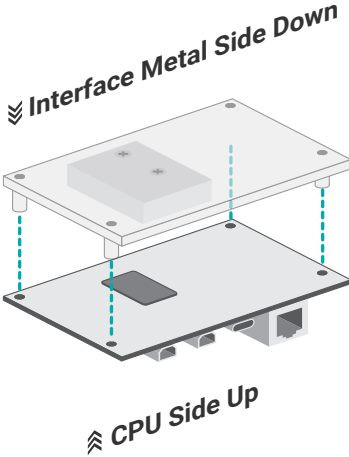

Rotate the module and heat spreader combo so that the I/O is facing the desired side, and place the combo in the position of the chassis reserved for your module.

Align the screw holes of the combo to those on the chassis. The combo can be mounted onto the chassis in two manners — 1) module side to the chassis, or 2) heat spreader side to the chassis as illustrated below. This shall depend entirely on the design of the chassis with regard to interior spacing, thermal, and I/O.

Place the screws that come with the standard package into the screw holes, and use a screw driver to fasten the screws until the combo is securely fixed onto the chassis.

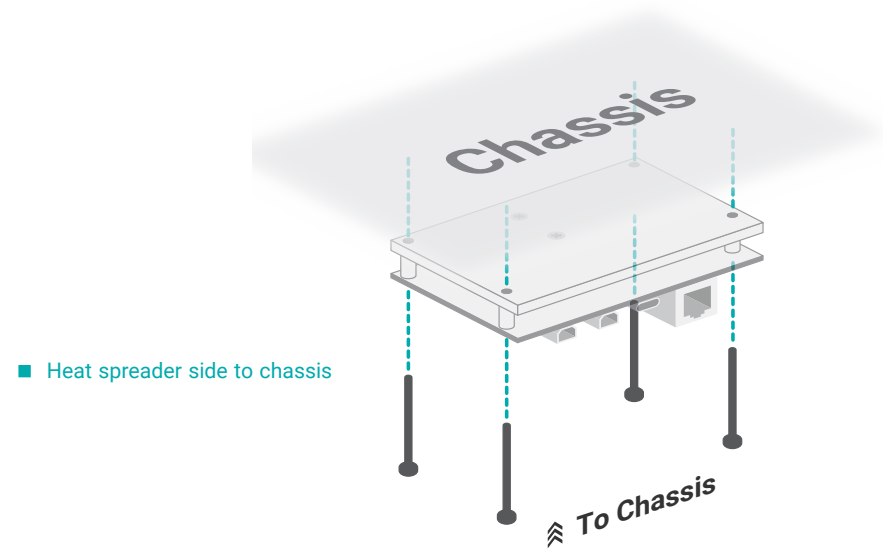
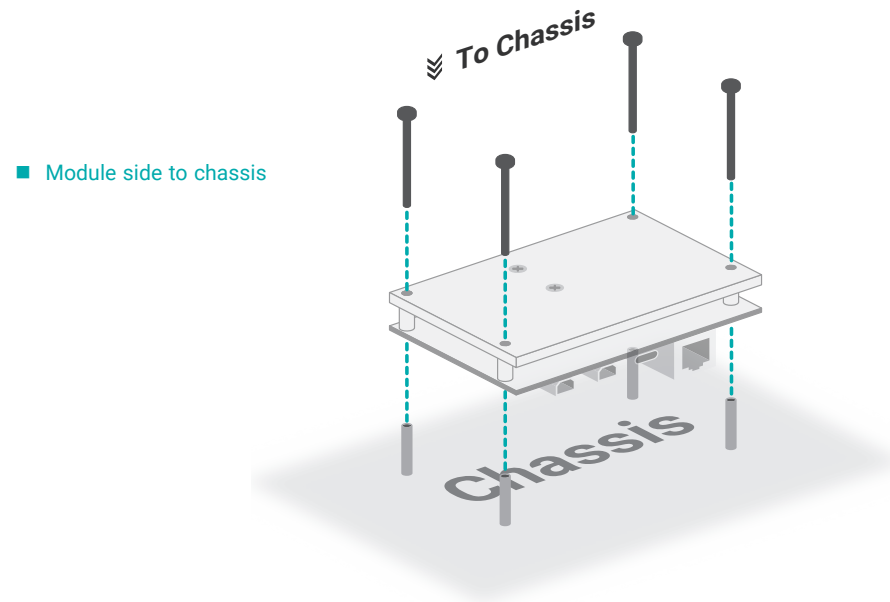

► **Jumper Settings**

Clear CMOS

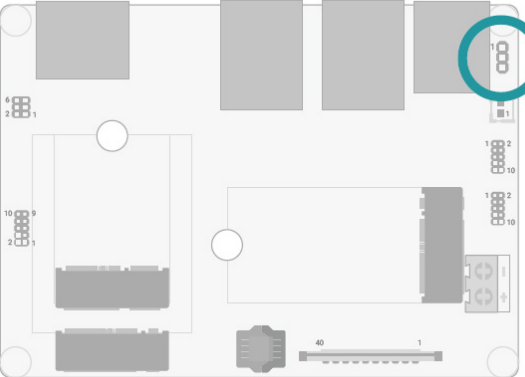

If any anomaly of the followings is encountered –

- a) CMOS data is corrupted;
- b) you forgot the supervisor or user password;
- c) failure to start the system due to BIOS mis-configuration

– it is suggested that the system be reconfigured with default values stored in the ROM BIOS. To load the default values stored in the ROM BIOS, please follow the steps below.

1. Power-off the system and unplug the power cord.
2. Put a jumper cap on JP5's pin 2 and pin 3. Wait for a few seconds and set JP5 back to its default setting, i.e. jumper cap on pin 1 and pin 2.
3. Plug the power cord and power-on the system.



■ 1-2 On: Normal (default)



■ 2-3 On: Clear CMOS

► **Rear I/O Ports**

Rear

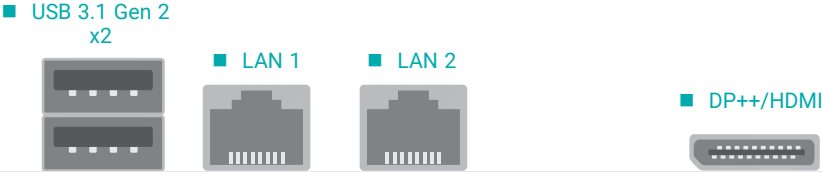

Side

■ eDP

The rear panel I/O ports consist of the following:

- 1 HDMI / DP++ port
- 2 RJ45 LAN ports
- 2 USB 3.1 Gen2 ports
- 1 eDP Port

► **Rear I/O Ports**

USB Ports

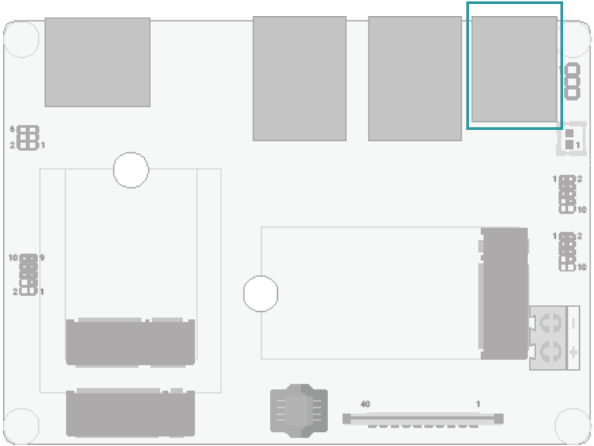

■ USB 3.1 Gen 2 x2



USB allows data exchange between your computer and a wide range of simultaneously accessible external Plug and Play peripherals.

Wake-On-USB Keyboard/Mouse

The Wake-On-USB Keyboard/Mouse function allows you to use a USB keyboard or USB mouse to wake up a system from the S3 (STR - Suspend To RAM) state.

▶ Rear I/O Ports

Graphics Display

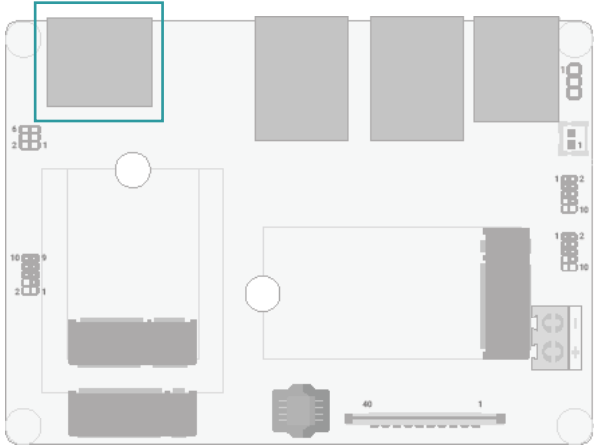

DisplayPort ++

The DisplayPort (DP) is a digital display interface used to connect a display device such as a computer monitor. It is used to transmit audio and video simultaneously. The interface, which is developed by VESA, delivers higher performance features than any other digital interface. DP++ is supported by the system board for converting to DVI and HDMI signals.

HDMI

The HDMI port which carries both digital audio and video signals is used to connect a LCD monitor or digital TV that has the HDMI port.

▶ Rear I/O Ports

LAN

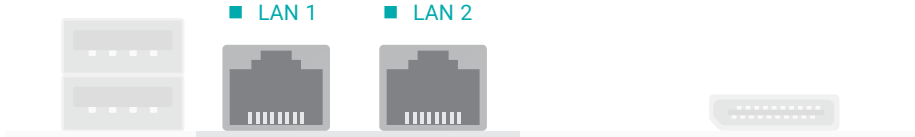
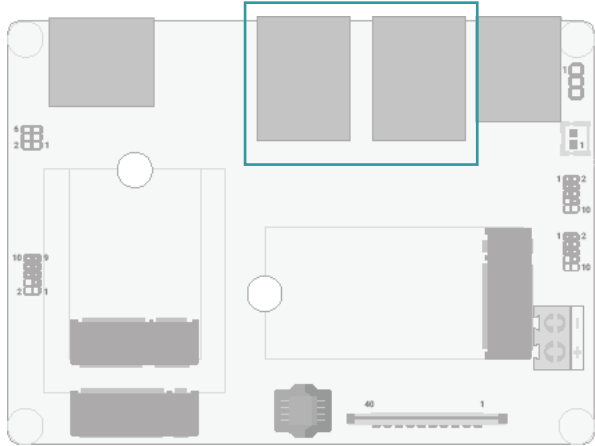

LAN1/LAN2 (RJ45)

The onboard RJ45 LAN port allows the system board to connect to a local area network by means of a network hub.

▶ Rear I/O Ports

Graphics Display

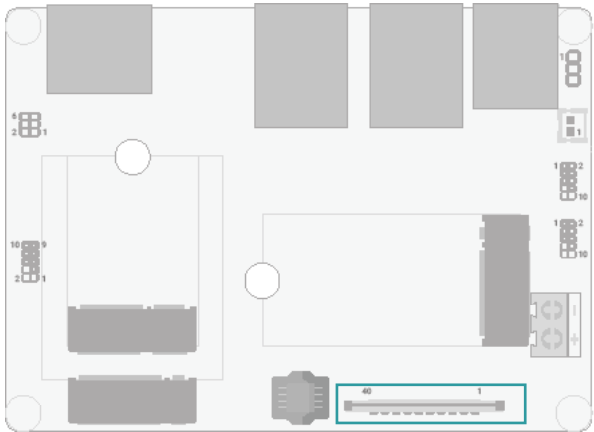

■ eDP

eDP

The eDP is a variation of the DisplayPort interface. It has the advantages of power and space saving and high-speed transmission. These advantages make it suitable for providing internal connectivity for embedded displays.

(The length of customized cable was advised to be limited to 350mm)

■ eDP Pin Assignment (Horizontal Slot)

Pin	Assignment	Pin	Assignment
1	--	21	eDP_PANEL_PWR
2	GND	22	--
3	eDP_TXN3	23	GND
4	eDP_TXP3	24	GND
5	GND	25	GND
6	eDP_TXN2	26	GND
7	eDP_TXP2	27	eDP_HPD_CN
8	GND	28	GND
9	eDP_TXN1	29	GND
10	eDP_TXP1	30	GND
11	GND	31	GND
12	eDP_TXN0	32	BLONOFF
13	eDP_TXP0	33	DIMMING
14	GND	34	--
15	eDP_AUXP	35	--
16	eDP_AUXN	36	Inverter Power_C
17	GND	37	Inverter Power_C
18	eDP_PANEL_PWR	38	Inverter Power_C
19	eDP_PANEL_PWR	39	Inverter Power_C
20	eDP_PANEL_PWR	40	--

■ eDP Pin Assignment (Vertical Slot)

Pin	Assignment	Pin	Assignment
1	--	21	eDP_PANEL_PWR
2	GND	22	--
3	eDP_TXN3	23	GND
4	eDP_TXP3	24	GND
5	GND	25	GND
6	eDP_TXN2	26	GND
7	eDP_TXP2	27	eDP_HPD_CN
8	GND	28	GND
9	eDP_TXN1	29	GND
10	eDP_TXP1	30	GND
11	GND	31	GND
12	eDP_TXN0	32	BLONOFF
13	eDP_TXP0	33	DIMMING
14	GND	34	--
15	eDP_AUXP	35	--
16	eDP_AUXN	36	Inverter Power_C
17	GND	37	Inverter Power_C
18	eDP_PANEL_PWR	38	Inverter Power_C
19	eDP_PANEL_PWR	39	Inverter Power_C
20	eDP_PANEL_PWR	40	--

► **Internal I/O Connectors**

SMBus

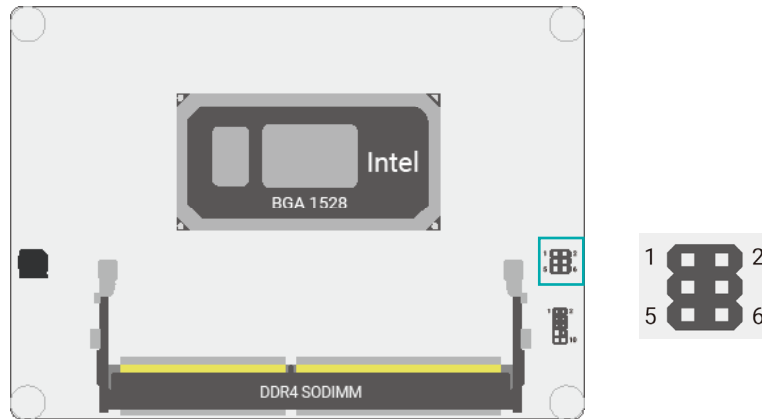

The SMBus (System Management Bus) connector is used to connect the SMBus device. It is a multiple device bus that allows multiple chips to connect to the same bus and enable each one to act as a master by initiating data transfer.

■ SMBus Pin Assignment

Pin	Assignment	Pin	Assignment
1	3V3SB	2	GND
3	SMBus_Clock	4	SMBus_SDA
5	SMBus_Alert	6	N.C.

▶ Internal I/O Connectors

USB Ports

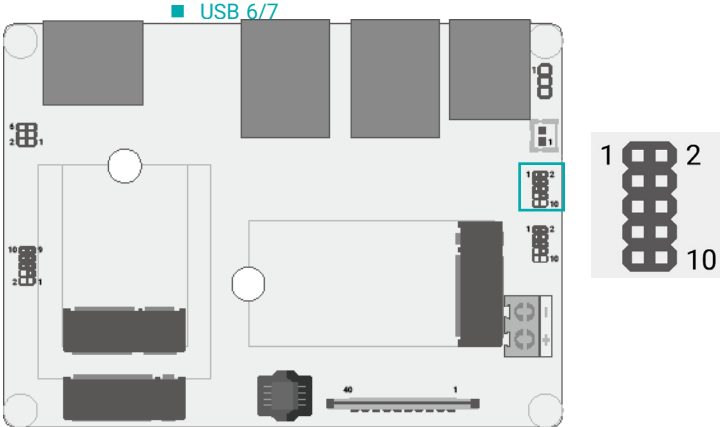

The USB device allows data exchange between your computer and a wide range of simultaneously accessible external Plug and Play peripherals.

The internal USB pin headers may be connected to a card-edge bracket. Install the card-edge bracket to an available slot at the rear of the system chassis and then insert the USB port cables to a connector.

Wake-On-USB Keyboard/Mouse

The Wake-On-USB Keyboard/Mouse function allows you to use a USB keyboard or USB mouse to wake up the system from the S state(s).

■ USB2.0 Pin Assignment

Pin	Assignment	Pin	Assignment
1	5V_USB6_7	2	5V_USB6_7
3	USB2_6_C_N	4	USB2_7_C_N
5	USB2_6_C_P	6	USB2_7_C_P
7	GND	8	GND
9	N.C.	10	N.C.

▶ Internal I/O Connectors

Front Audio

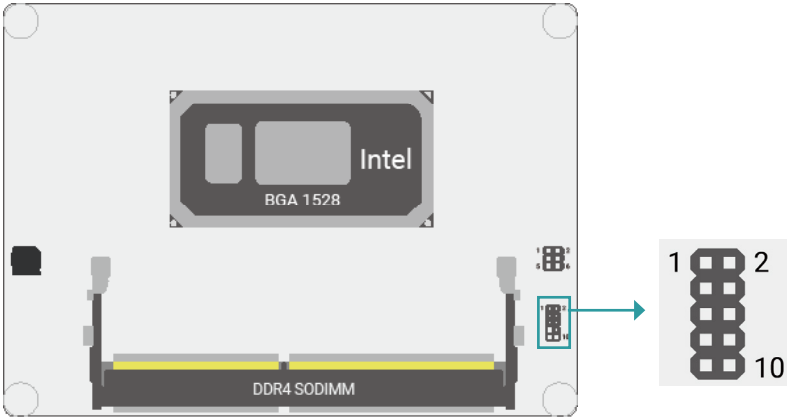

The Front Audio internal connector allows you to connect to the second line-out and mic-in jacks that are at the front panel of your system.

■ Front Audio Pin Assignment

Pin	Assignment	Pin	Assignment
1	Mic2-L	2	GND
3	Mic2-R	4	N.C.
5	Line2-R	6	Mic2-JD
7	GND	8	N.C.
9	Line2-L	10	Line2-JD

▶ Internal I/O Connectors

Digital I/O

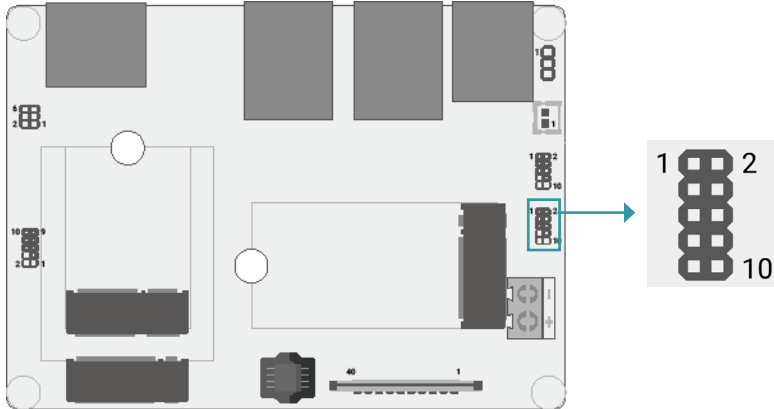

The Digital I/O (DIO) connector allows for input/output signals of digital logical states defined by voltage levels.

■ Digital I/O Pin Assignment

Pin	Assignment	Pin	Assignment
1	DIO_7	2	DIO_6
3	DIO_5	4	DIO_4
5	DIO_3	6	DIO_2
7	DIO_1	8	DIO_0
9	5V	10	GND

► Internal I/O Connectors

Power Connector

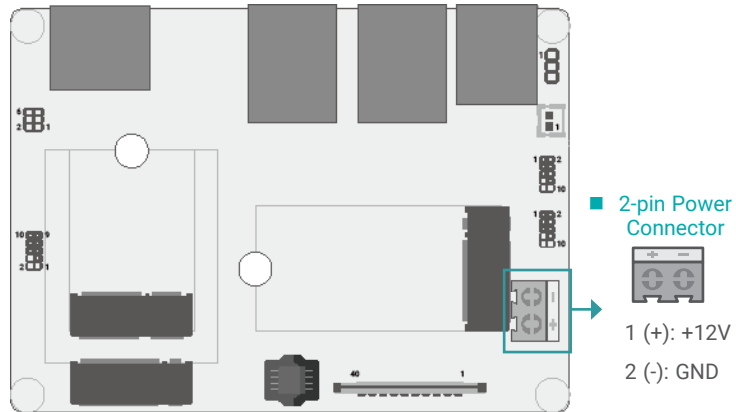

This 2-pin terminal block is considered a low power solution.

Connect a DC power cord to this terminal block by inserting the wire into the block and then screw tight the screw on top to secure the wire in place. Please make sure the positive and negative wires are installed correctly.

Using a voltage more than the recommended range may fail to boot the system or cause damage to the system board.

► Internal I/O Connectors

Front Panel

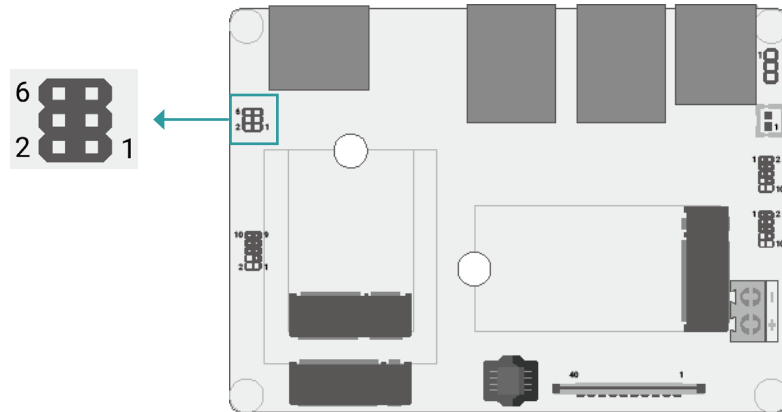

■ Front Panel Pin Assignment

Pin	Assignment	Pin	Assignment
1	PWSIN	2	3V3SB
3	GND	4	SUS_LED
5	RESET	6	HD_LED

■ Front Panel Pin Combination

	Pin	Name		Pin	Name
PWR-LED	2	3V3SB	PWR-SW	1	PWSIN
	4	SUS_LED		3	GND
HD-LED	2	3V3SB	RESET	3	GND
	6	HD_LED		5	RESET

PWR-LED - Power/Standby LED

When the system's power is on, this LED will light. When the system is in the S1 (POS - Power On Suspend) state, it will blink every second. When the system is in the S3 (STR - Suspend To RAM) state, it will blink every 4 seconds.

HD-LED - Hard Drive LED

This LED will light when the hard drive is being accessed.

PWR-SW - Power Switch

This switch is used to power on or off the system.

RESET - Reset Switch

This switch allows you to reboot without having to power off the system.

▶ Internal I/O Connectors

Battery Header

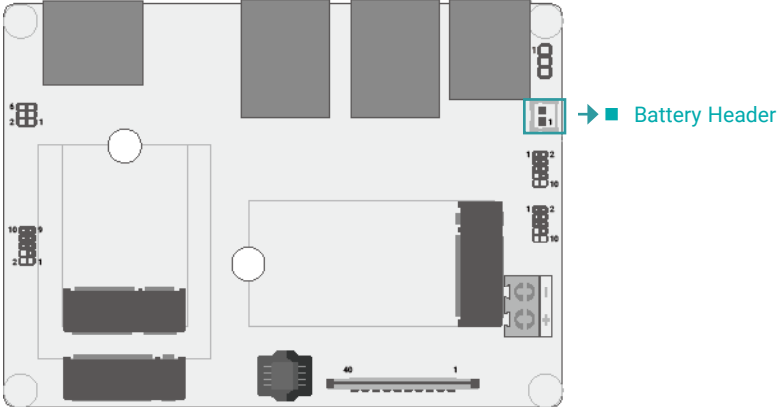

The lithium ion battery powers the real-time clock and CMOS memory. It is an auxiliary source of power when the main power is shut off.

A battery wrapped with an adhesive tape connects to the header, the tape helps position the battery at a proper place in the case.

Safety Measures

- Danger of explosion if battery incorrectly replaced.
- Replace only with the same or equivalent type recommended by the manufacturer.
- Dispose of used batteries according to local ordinance.
- Higher temperature or harsh environment may limit the functionality of the tape wrapped on battery.

Chapter 3 - BIOS Settings

► Overview

The BIOS is a program that takes care of the basic level of communication between the CPU and peripherals. It contains codes for various advanced features found in this system board.

The BIOS allows you to configure the system and save the configuration in a battery-backed CMOS so that the data retains even when the power is off. In general, the information stored in the CMOS RAM of the EEPROM will stay unchanged unless a configuration change has been made such as a hard drive replaced or a device added.

It is possible that the CMOS battery will fail causing CMOS data loss. If this happens, you need to install a new CMOS battery and reconfigure the BIOS settings.



Note:

The BIOS is constantly updated to improve the performance of the system board; therefore the BIOS screens in this chapter may not appear the same as the actual one. These screens are for reference purpose only.

Default Configuration

Most of the configuration settings are either predefined according to the Load Optimal Defaults settings which are stored in the BIOS or are automatically detected and configured without requiring any actions. There are a few settings that you may need to change depending on your system configuration.

Entering the BIOS Setup Utility

The BIOS Setup Utility can only be operated from the keyboard and all commands are keyboard commands. The commands are available at the right side of each setup screen.

The BIOS Setup Utility does not require an operating system to run. After you power up the system, the BIOS message appears on the screen and the memory count begins. After the memory test, the message “Press DEL to run setup” will appear on the screen. If the message disappears before you respond, restart the system or press the “Reset” button. You may also restart the system by pressing the <Ctrl> <Alt> and keys simultaneously.

Legends

Keys	Function
Right / Left arrow	Move the highlight left or right to select a menu
Up / Down arrow	Move the highlight up or down between submenus or fields
<Enter>	Enter the highlighted submenu
+ (plus key)/F6	Scroll forward through the values or options of the highlighted field
- (minus key)/F5	Scroll backward through the values or options of the highlighted field
<F1>	Display general help
<F2>	Display previous values
<F9>	Optimized defaults
<F10>	Save and Reset
<Esc>	Exit

Scroll Bar

When a scroll bar appears to the right of the setup screen, it indicates that there are more available fields not shown on the screen. Use the up and down arrow keys to scroll through all the available fields.

Submenu

When “►” appears on the left of a particular field, it indicates that a submenu which contains additional options are available for that field. To display the submenu, move the highlight to that field and press <Enter>.

► Main

The Main menu is the first screen that you will see when you enter the BIOS Setup Utility.

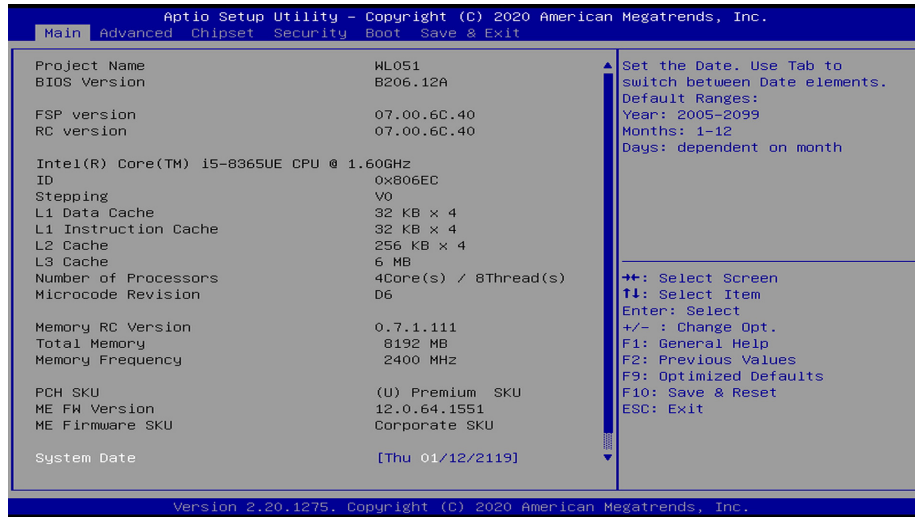

System Date

The date format is <month>, <date>, <year>. Press "Tab" to switch to the next field and press "-" or "+" to modify the value.

System Time

The time format is <hour>, <minute>, <second>. The time is based on the 24-hour military-time clock. For example, 1 p.m. is 13:00:00. Hour displays hours from 00 to 23. Minute displays minutes from 00 to 59. Second displays seconds from 00 to 59.

► Advanced

The Advanced menu allows you to configure your system for basic operation. Some entries are defaults required by the system board, while others, if enabled, will improve the performance of your system or let you set some features according to your preference.



Important:

Setting incorrect field values may cause the system to malfunction.

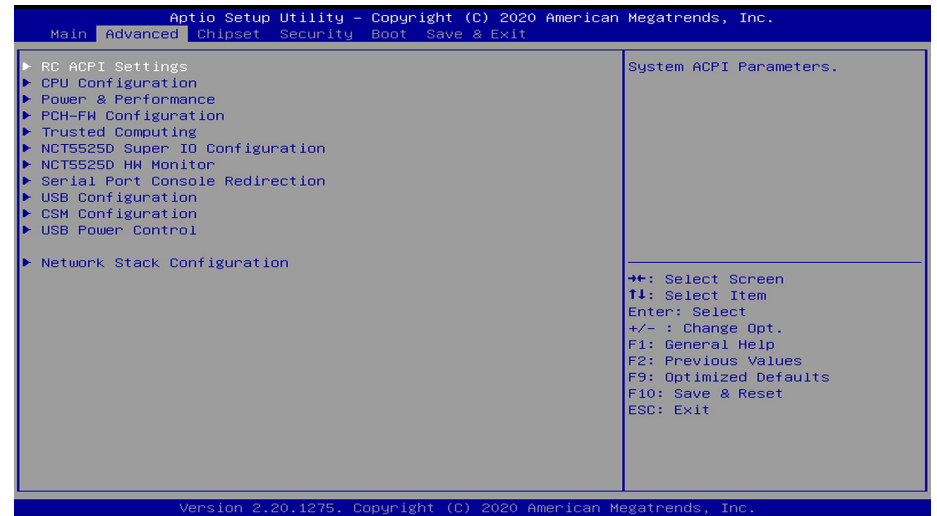

► Advanced

RC ACPI Configuration

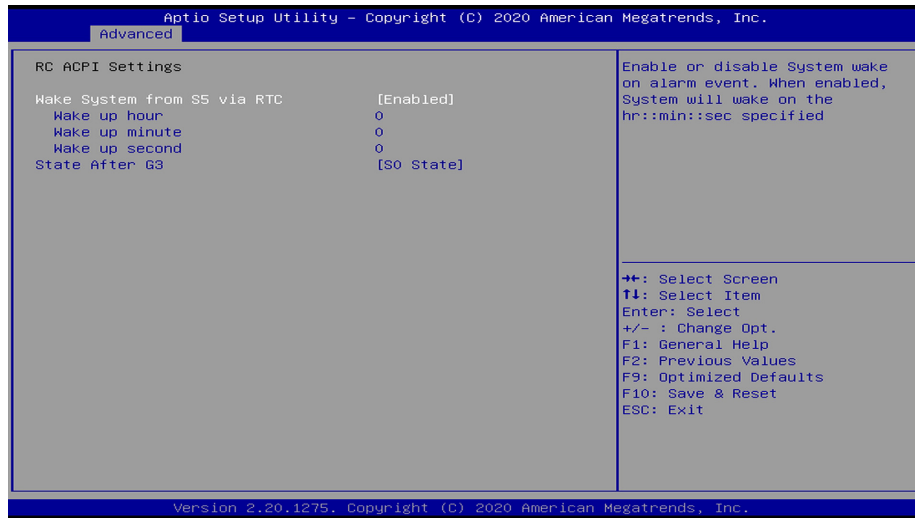

Wake system from S5

When Enabled, the system will automatically power up at a designated time every day. Once it's switched to [Enabled], please set up the time of day including hour, minute, and second for the system to wake up.

State After G3

To choose a re-applied state (S0,S5,Last State) after a power-failure (G3 State).

► Advanced

CPU Configuration

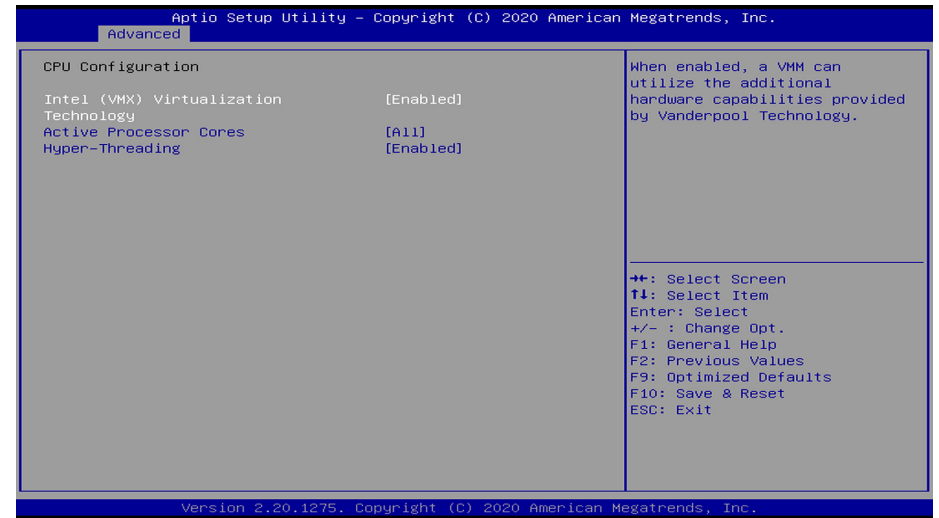

Intel (VMX) Virtualization Technology

When this field is set to Enabled, the VMM can utilize the additional hardware capabilities provided by Vanderpool Technology.

Active Processor Cores

Select number of cores to enable in each processor package.

Hyper-threading

Enables this field for Windows and Linux which are optimized for Hyper-Threading technology. Select disabled for other OSes not optimized for Hyper-Threading technology. When disabled, only one thread per enabled core is enabled.



Note:

Some of the fields may not be available when the features are not supported by the equipped CPU.

► Advanced

Power & Performance

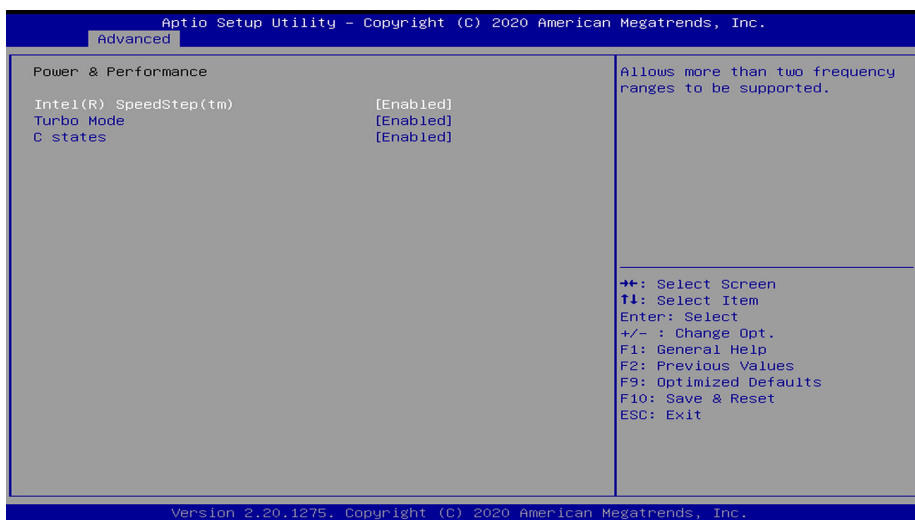

Intel(R) SpeedStep(tm)

This field is used to enable or disable the Intel SpeedStep® Technology, which helps optimize the balance between system's power consumption and performance. After it is enabled in the BIOS, EIST features can then be enabled via the operating system's power management.

C states

Enable or disable CPU Power Management. It allows CPU to enter "C states" when it's idle and no process is running.

► Advanced

PCH-FW Configuration



ME State

When this field is set to Disabled, ME will be put into ME Temporarily Disabled Mode.

Manageability Features State

Enable or disable Intel(R) Manageability features. This option disables or enables Manageability Features support in FW. To disable it, support platform must be in an unprovisioned state first.

AMT BIOS Features

When disabled, AMT BIOS features are no longer supported and user is no longer able to access MEBx Setup. This option does not disable manageability features in FW.

ME Unconfig on RTC Clear

When disabled, ME will not be unconfigured on RTC Clear.



Note:

The sub-menus are detailed in following sections.

▶ Advanced ▶ PCH-FW Configuration

▶ **AMT Configuration**

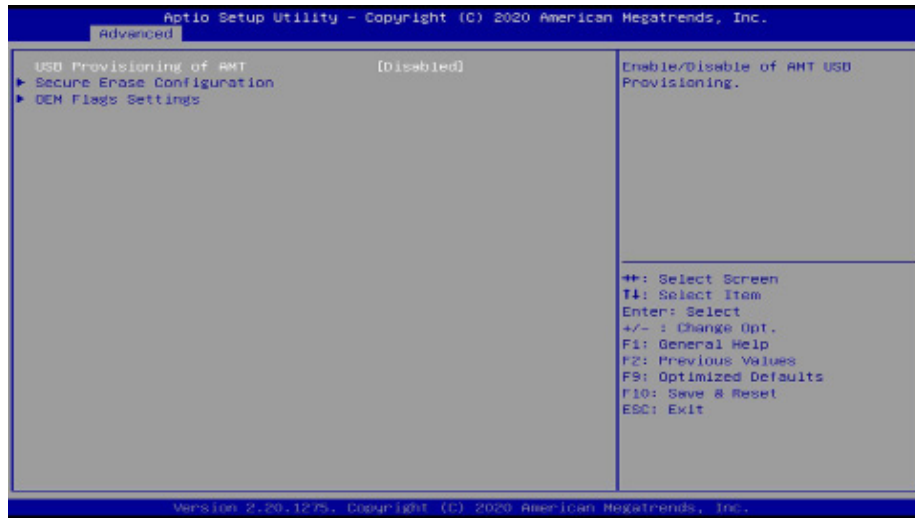

USB Provisioning of AMT

Enable or disable AMT USB Provisioning.

▶ Advanced ▶ PCH-FW Configuration

▶ **AMT Configuration** ▶ **Secure Erase Configuration**



Secure Erase Mode

Select Secure Erase module behavior: Simulated or Real.

Force Secure Erase

Enable or disable Force Secure Erase on next boot.

▶ Advanced ▶ PCH-FW Configuration

▶ AMT Configuration ▶ OEM Flags Settings



Hide Unconfigure ME Confirmation Prompt

Enable or disable to hide unconfigure ME confirmation prompt when attempting to unconfigure ME.

Unconfigure ME

Enable or disable to unconfigure ME with resetting password to default.

▶ Advanced ▶ PCH-FW Configuration

▶ Firmware Update Configuration



Me FW Image Re-Flash

This field is used to enable or disable the ME FW Image Re-Flash function, which allows the user to update the ME firmware.

▶ Advanced

Trusted Computing

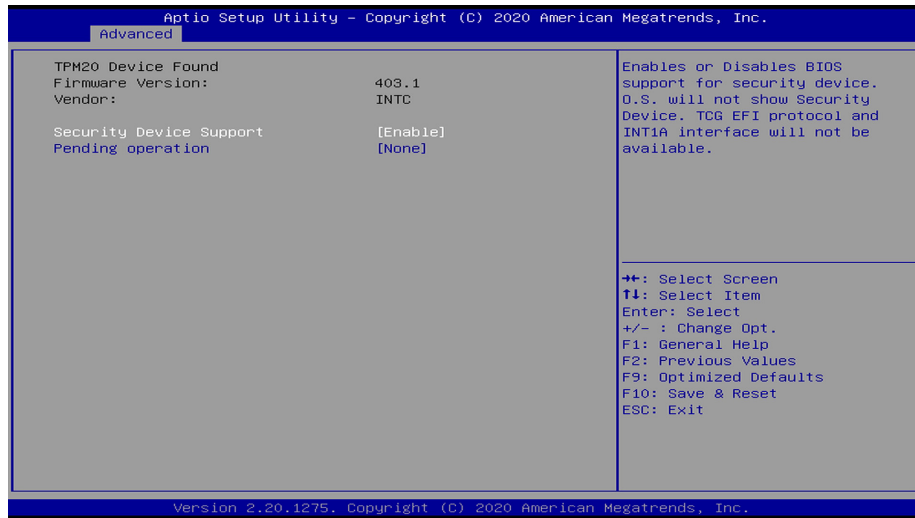

Security Device Support

This field is used to enable or disable BIOS support for the security device such as TPM 2.0 to achieve hardware-level security via cryptographic keys.

Pending operation

Schedule an operation for the Security Device, the change of state needs a reboot.

▶ Advanced

NCT5525D Super IO Configuration

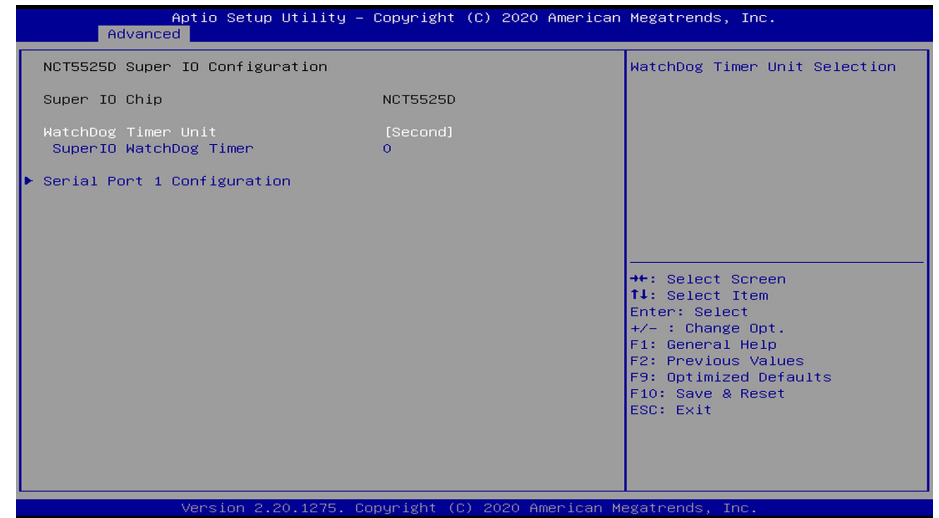

WatchDog Timer Unit

Select WatchDog Timer Unit – Second or Minute.

SuperIO WatchDog Timer

Set SuperIO WatchDog Timer Timeout value. The range is from 0 (disabled) to 255.



Note:

The sub-menus are detailed in following sections.

▶ **Serial Port Configuration**

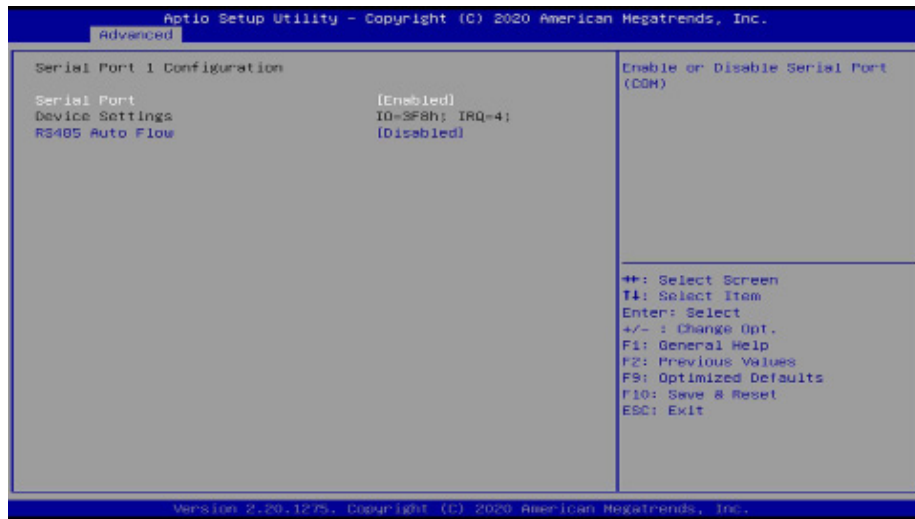

Serial Port

Enable or disable the current serial COM port.

RS485 Auto Flow

Enable or disable RS485 auto flow. This field is only available for COM ports that support RS485 mode.

NCT5525D HW Monitor

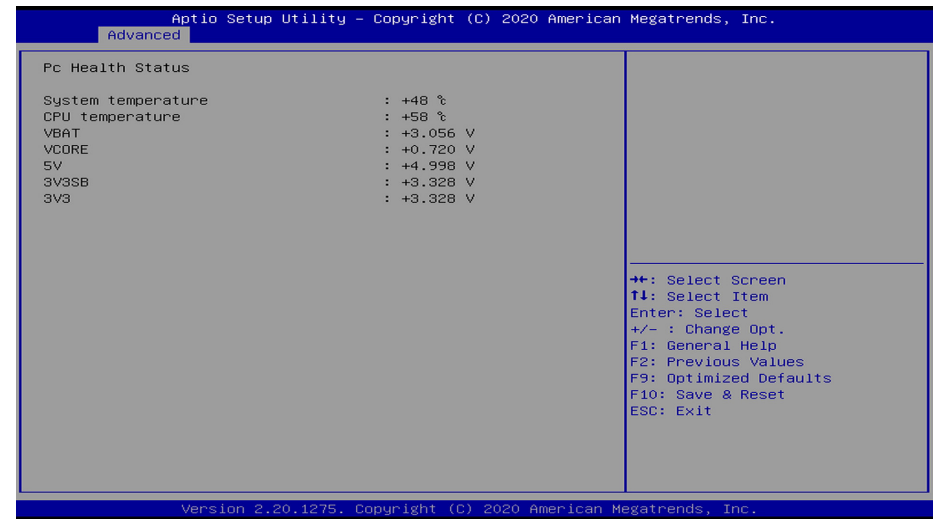

This section displays the system's health information, i.e. voltage readings, CPU and system temperatures.

► Advanced

Serial Port Console Redirection

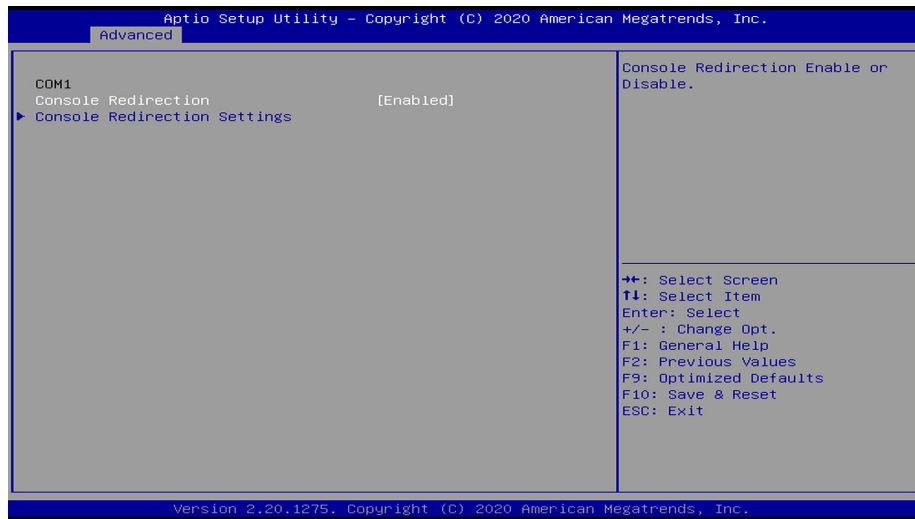

Console Redirection

By enabling Console Redirection of a COM port, the sub-menu of console redirection settings will become available for configuration as detailed in the following.

► Advanced ► Serial Port Console Redirection

► Console Redirection Settings

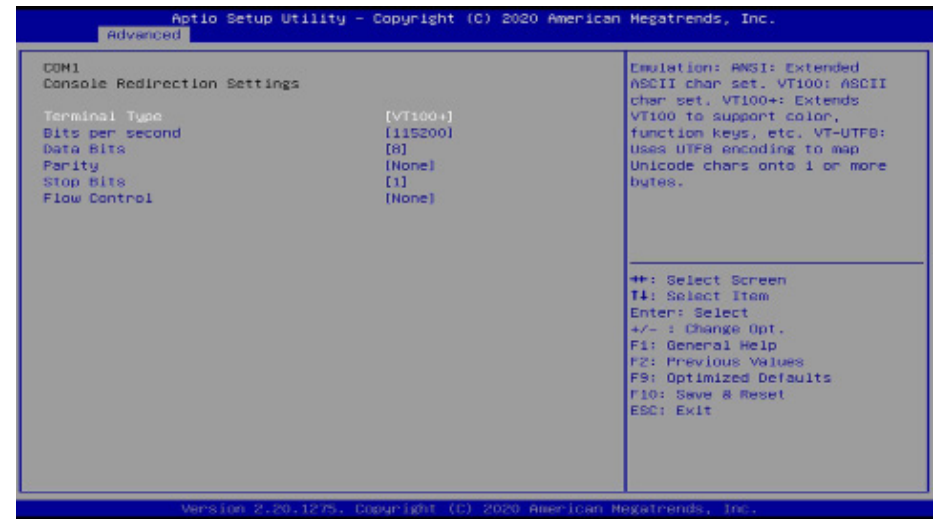

Configure the serial settings of the current COM port.

Terminal Type

Select terminal type: VT100, VT100+, VT-UTF8 or ANSI.

Bits per second

Select serial port transmission speed: 9600, 19200, 38400, 57600 or 115200.

Data Bits

Select data bits: 7 bits or 8 bits.

Parity

Select parity bits: None, Even, Odd, Mark or Space.

Stop Bits

Select stop bits: 1 bit or 2 bits.

Flow Control

Select flow control type: None or Hardware RTS/CTS.

► Advanced

USB Configuration

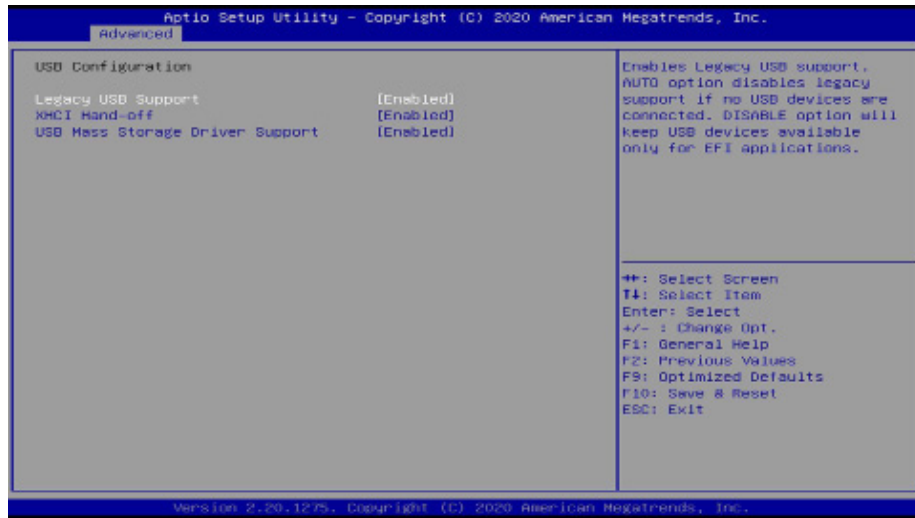

Legacy USB Support

- Enabled** Enable Legacy USB support.
- Disabled** Keep USB devices available only for EFI applications.
- Auto** Disable Legacy support if no USB devices are connected.

XHCI Hand-off

Enable or disable XHCI Hand-off.

USB Mass Storage Driver Support

Enable or disable USB Mass Storage Driver Support.

► Advanced

CSM Configuration



CSM Support

This section is used to enable or disable CSM Support. The following fields are only available when "CSM Support" is enabled.

Boot option filter

This field controls Legacy/UEFI ROMs priority.

Network

This field controls the execution of UEFI and Legacy Network OpROM.

Storage

This field controls the execution of UEFI and Legacy Storage OpROM.

Video

This field controls the execution of UEFI and Legacy Video OpROM.

Other PCI devices

This field determines OpROM execution policy for devices other than Network, Storage or Video.

► Advanced

USB Power Control

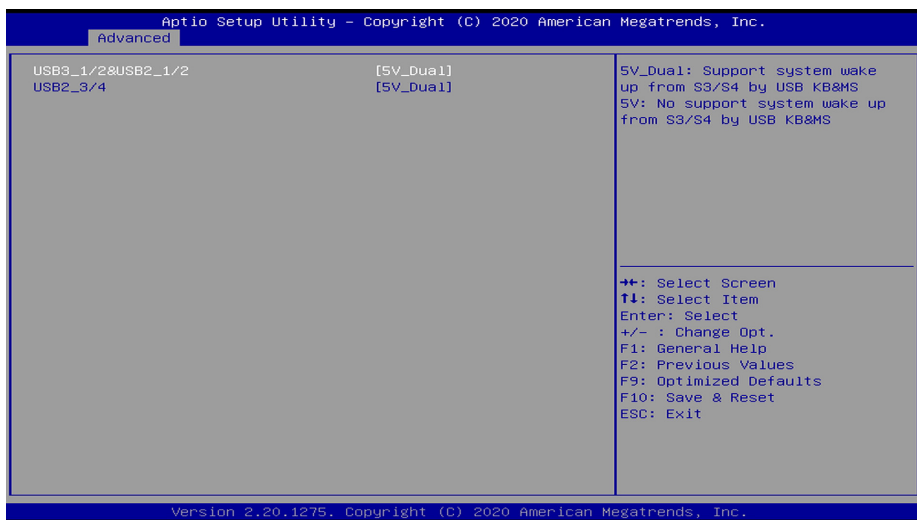

5V / 5V_DUAL

5V Dual supports wake up from S3/S4 state by USB keyboard or mouse while 5V does not.

► Advanced

Network Stack Configuration

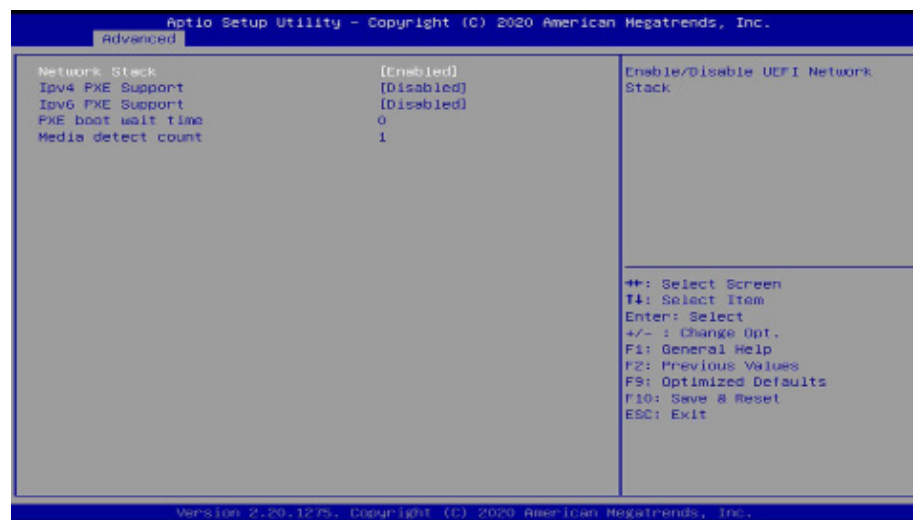

Network Stack

Enable or disable UEFI network stack. The following fields will appear when this field is enabled.

Ipv4 PXE Support

Enable or disable IPv4 PXE boot support. If disabled, IPv4 PXE boot support will not be available.

Ipv6 PXE Support

Enable or disable IPv6 PXE boot support. If disabled, IPv6 PXE boot support will not be available.

PXE boot wait time

Set the wait time in seconds to press ESC key to abort the PXE boot. Use either +/- or numeric keys to set the value.

Media detect count

Set the number of times the presence of media will be checked. Use either +/- or numeric keys to set the value.

► Chipset

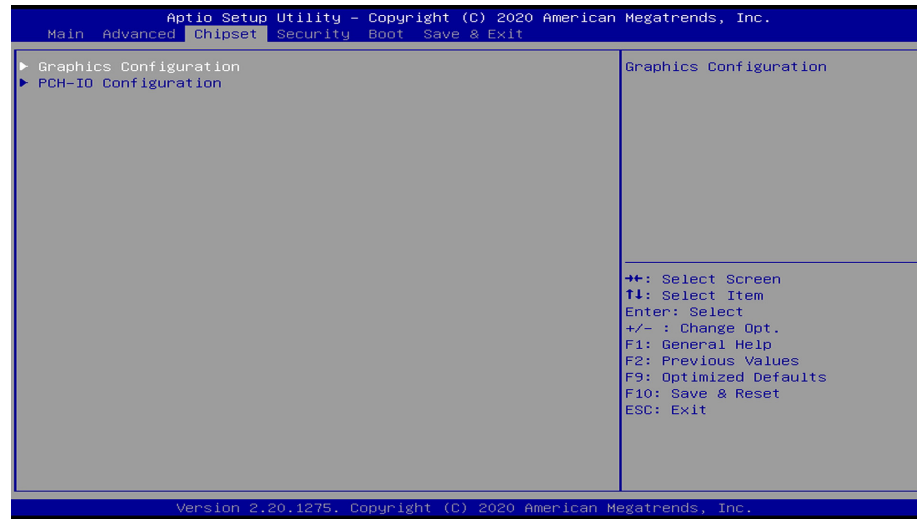

To configure graphics and PCH-I/O relevant settings.

► Chipset

Graphics Configuration



Primary Display

Select which of IGFX/PEG/PCI Graphics device to be the primary display.

Internal Graphics

Keep IGFX enabled based on the setup options.

▶ Chipset

PCH-IO Configuration

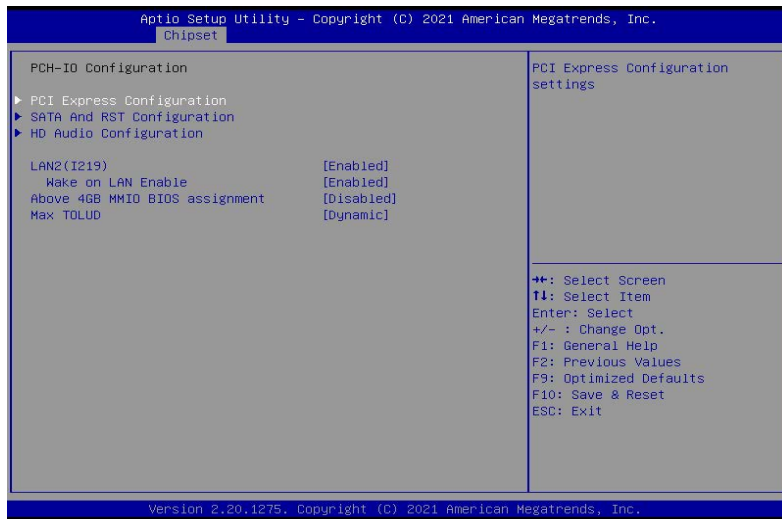

LAN2(I219)

Enable or disable onboard NIC.

Wake on LAN Enable

Enable or disable integrated LAN to wake the system.

Above 4GB MMIO BIOS assignment

Enable or disable MemoryMappedIO BIOS assignment above 4GB.

This option is enabled by default if Aperture Size is set to 2048MB.

Max TOLUD

Adjust the maximum value of TOLUD or set it to Dynamic to vary based on largest MMIO length of installed graphic controller.



Note:

The sub-menus are detailed in following sections.

▶ Chipset ▶ PCH-IO Configuration

PCI Express Configuration

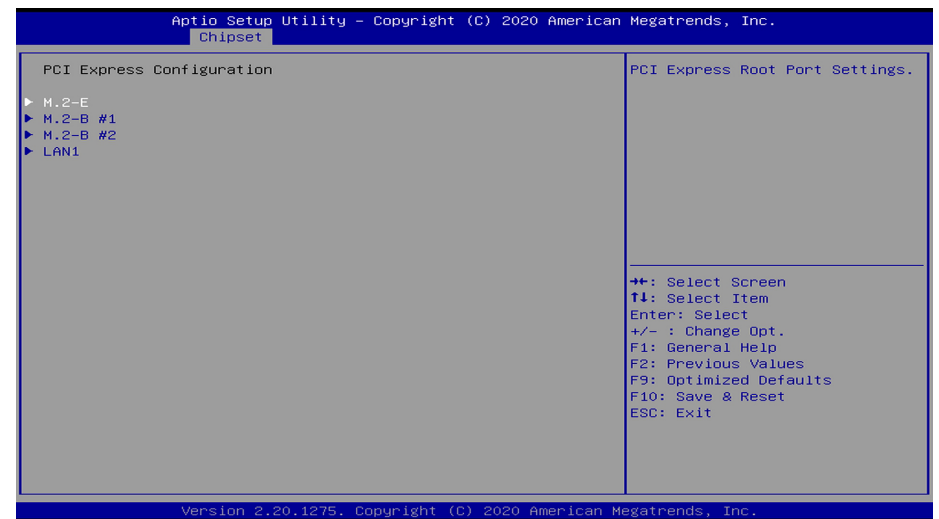

Select one of the PCI Express channels and press enter to configure the following settings.

PCI Express Devices

Enable or disable the PCI Express Root Port.

PCIe Speed

Select PCIe Speed of the current port – AUTO, Gen1, Gen 2, or Gen3. Gen 3 is only available for the PCIe1 port. This field may not appear when the speed of the port is not configurable.

Hot Plug

Enable or disable hot plug function of the port. This field may not appear when the port does not support hot plug.

Detect Non-Compliance Device

Enable to detect non-Compliance PCI Express Device by consuming more POST time.

► **Advanced**

SATA And RST Configuration

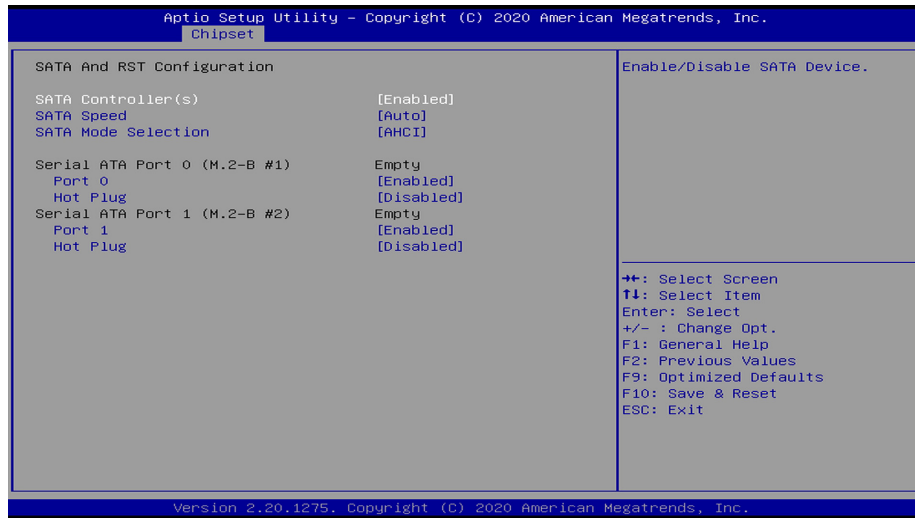

SATA Controller(s)

This field is used to enable or disable the Serial ATA controller.

SATA Speed

This field is used to select SATA speed generation limit: Auto, Gen1, Gen2 or Gen3.

SATA Mode Selection

The mode selection determines how the SATA controller(s) operates.

AHCI This option allows the Serial ATA controller(s) to use AHCI (Advanced Host Controller Interface).

Intel RST Premium With Intel Optane System Acceleration This option allows you to create RAID or Intel Rapid Storage configuration along with Intel® Optane™ system acceleration on Serial ATA devices.

Use RST Legacy OROM

This field shows up when SATA Mode Selection is set to Intel RST Premium With Intel Optane System Acceleration.

Port and Hot Plug

Enable or disable the Serial ATA port and its hot plug function.

► **Chipset** ► **PCH-IO Configuration**

HD Audio Configuration



HD Audio

Control the detection of the HD Audio device.

Disabled HDA will be unconditionally disabled.

Enabled HDA will be unconditionally enabled.

► Security



Administrator Password

Set the administrator password. To clear the password, input nothing and press enter when a new password is asked. Administrator Password will be required when entering the BIOS.

User Password

Set the user password. To clear the password, input nothing and press enter when a new password is asked. User Password will be required when powering up the system.

► Security

Secure Boot



Secure Boot

The Secure Boot store a database of certificates in the firmware and only allows the OSeS with authorized signatures to boot on the system. To activate Secure Boot, please make sure that "Secure Boot" is "[Enabled]", Platform Key (PK) is enrolled, "System Mode" is "User", and CSM is disabled. After enabling/disabling Secure Boot, please save the configuration and restart the system. When configured and activated correctly, the Secure Boot status will be "Active".

Secure Boot Customization

Select the secure boot mode – Standard or Custom. When set to Custom, the following fields will be configurable for the user to manually modify the key database.

Restore Factory Keys

Force system to User Mode. Load OEM-defined factory defaults of keys and databases onto the Secure Boot. Press Enter and a prompt will show up for you to confirm.

Reset To Setup Mode

Clear the database from the NVRAM, including all the keys and signatures installed in the Key Management menu. Press Enter and a prompt will show up for you to confirm.

▶ Key Management

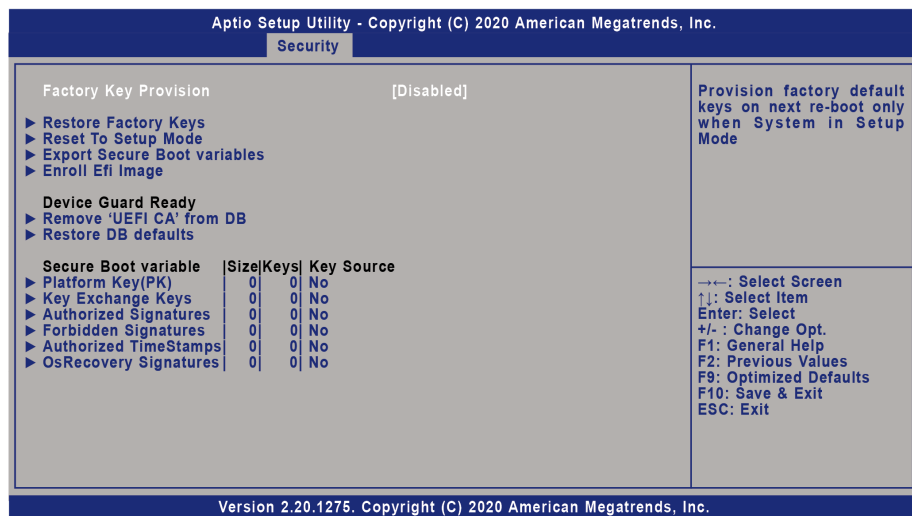

Factory Key Provision

Enable or disable the provision factory default keys on next re-start. This will only take place when the “System Mode” in the previous menu is in “Setup”, which can be achieved by moving the cursor to the “Reset To Setup Mode” and press Enter.

Restore Factory Keys

Force system to User Mode. Configure NVRAM to contain OEM-defined factory default Secure Boot keys.

Reset To Setup Mode

Clear the database from the NVRAM, including all the keys and signatures installed in the Key Management menu. Press Enter and a prompt will show up for you to confirm.

Export Secure Boot variables

Export the Secure Boot settings (i.e. all keys and signatures) as files to the root directory of a file system device. Press Enter and select a storage device listed in the pop-up menu. The saved files will be named automatically according to the type of key/signature as listed below.

- “PK” for Platform Keys
- “KEK” for Key Exchange Keys
- “db” for Authorized Signatures
- “dbx” for Forbidden Signatures

Enroll Efi Image

Allow the image to run in Secure Boot mode. Enroll SHA256 Hash certificate of a PE image into Authorized Signature Database (db). Press Enter and select a storage device listed in the pop-up menu, select a directory, and then select the EFI Image document.

Remove ‘UEFI CA’ from DB

Remove Microsoft UEFI CA from the Authorized Signature database. For systems that support Device Guard, Microsoft UEFI CA must NOT be included in the Authorized Signature database.

Restore DB defaults

Press Enter to restore the database variable to factory defaults.

Manually configure the following keys and signatures. Move the cursor to the field and press Enter, and then a pop-up menu will show up.

Platform Key(PK), Key Exchange Keys, Authorized Signatures, Forbidden Signatures, Authorized TimeStamps, OsRecovery Signatures

Details	List the information of enrolled keys and signatures
Export	Save the key or signature as a file to the root directory of a file system. The saved files will be named automatically according to the type of key/signature as previously listed in the “Export Secure Boot Variables”.
Update	Load factory default database
Append	Enroll keys and signatures from a file system
Delete	Delete keys and signatures

► **Boot**

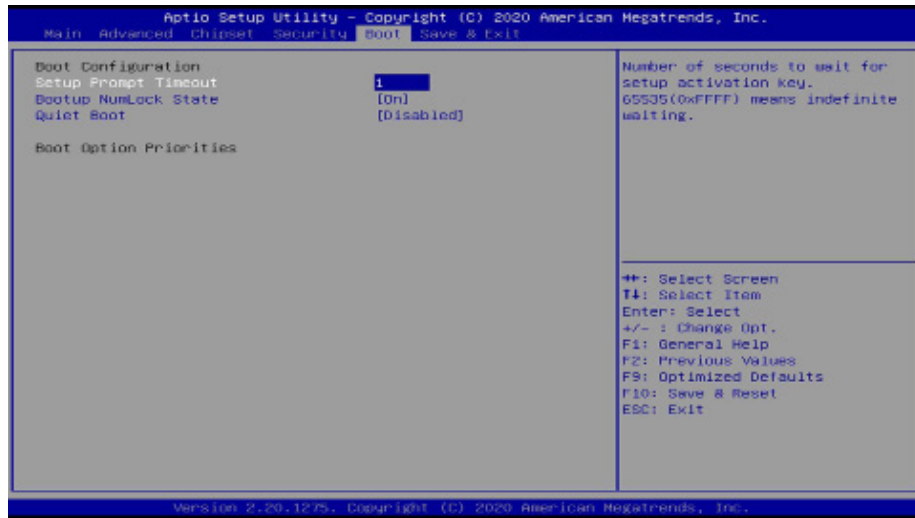

Setup Prompt Timeout

Set the number of seconds to wait for the setup activation key. 65535 (0xFFFF) denotes indefinite waiting.

Bootup NumLock State

Select the keyboard NumLock state: On or Off.

Quiet Boot

This section is used to enable or disable quiet boot option.

Boot Option Priorities

Rearrange the system boot order of available boot devices.

BGRT Logo

It is used to enable or disable to support display logo with ACPI BGRT table.



Note:

If "Boot option filter" of "CSM Configuration" is set to "UEFI and Legacy" or "UEFI only" and "Quiet Boot" is set to enabled, "BGRT Logo" will show up for configuration. Refer to the Advanced > CSM Configuration for more information.

► **Save & Exit**



Save Changes and Reset

To save the changes, select this field and then press <Enter>. A dialog box will appear. Select Yes to reset the system after saving all changes made.

Discard Changes and Reset

To discard the changes, select this field and then press <Enter>. A dialog box will appear. Select Yes to reset the system setup without saving any changes.

Restore Defaults

To restore and load the optimized default values, select this field and then press <Enter>. A dialog box will appear. Select Yes to restore the default values of all the setup options.

Boot Override

Move the cursor to an available boot device and press Enter, and then the system will immediately boot from the selected boot device. The Boot Override function will only be effective for the current boot. The "Boot Option Priorities" configured in the Boot menu will not be changed.

► **Save Setting to file**

Select this option to save BIOS configuration settings to a USB flash device.

► **Restore Setting from file**

This field will appear only when a USB flash device is detected. Select this field to restore setting from the USB flash device.

► Updating the BIOS

To update the BIOS, you will need the new BIOS file and a flash utility. Please contact technical support or your sales representative for the files and specific instructions about how to update BIOS with the flash utility. For updating AMI BIOS in UEFI mode, you may refer to the how-to video at <https://www.dfi.com/Knowledge/Video/5>.

► Notice: BIOS SPI ROM

1. The Intel® Management Engine has already been integrated into this system board. Due to the safety concerns, the BIOS (SPI ROM) chip cannot be removed from this system board and used on another system board of the same model.
2. The BIOS (SPI ROM) on this system board must be the original equipment from the factory and cannot be used to replace one which has been utilized on other system boards.
3. If you do not follow the methods above, the Intel® Management Engine will not be updated and will cease to be effective.



Note:

- a. You can take advantage of flash tools to update the default configuration of the BIOS (SPI ROM) to the latest version anytime.
- b. When the BIOS IC needs to be replaced, you have to populate it properly onto the system board after the EEPROM programmer has been burned and follow the technical person's instructions to confirm that the MAC address should be burned or not.

Chapter 4 - Intel AMT Settings

► Overview

Intel Active Management Technology (Intel® AMT) combines hardware and software solution to provide maximum system defense and protection to networked systems.

The hardware and software information are stored in non-volatile memory. With its built-in manageability and latest security applications, Intel® AMT provides the following functions.

Discover

Allows remote access and management of networked systems even while PCs are powered off; significantly reducing desk-side visits.

Repair

Remotely repair systems after OS failures. Alerting and event logging help detect problems quickly to reduce downtime.

Protect

Intel AMT's System Defense capability remotely updates all systems with the latest security software. It protects the network from threats at the source by proactively blocking incoming threats, reactively containing infected clients before they impact the network, and proactively alerting when critical software agents are removed.

► Enable Intel® AMT in the AMI BIOS

1. Power-on the system then press to enter the main menu of the AMI BIOS.
2. In the **Advanced** menu, select **PCH-FW Configuration**.
3. Set the **AMT BIOS Features** field to **Enabled**.

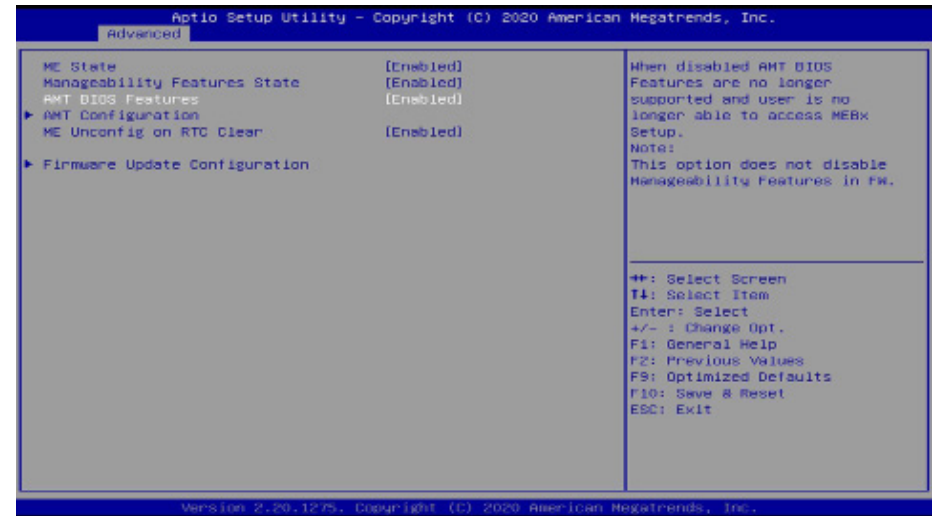

► Enable Intel® AMT in the AMI BIOS

4. Press F4, or go to the **Save & Exit** menu, select **Save Changes and Reset** and then press <Enter>. A dialog box will appear. Select **Yes** and press Enter to reset the system after saving all changes made.



► Entering Management Engine BIOS Extension (MEBX)

When the system reboots, the following message will be displayed. Press <Ctrl + P> as soon as the message is displayed. This message will only be displayed very briefly.



► **MEBX**

Main Menu

Select **MEBx Login** under Main Menu and press Enter. A prompt that requires password input will show up.

1. Enter the default password "admin".

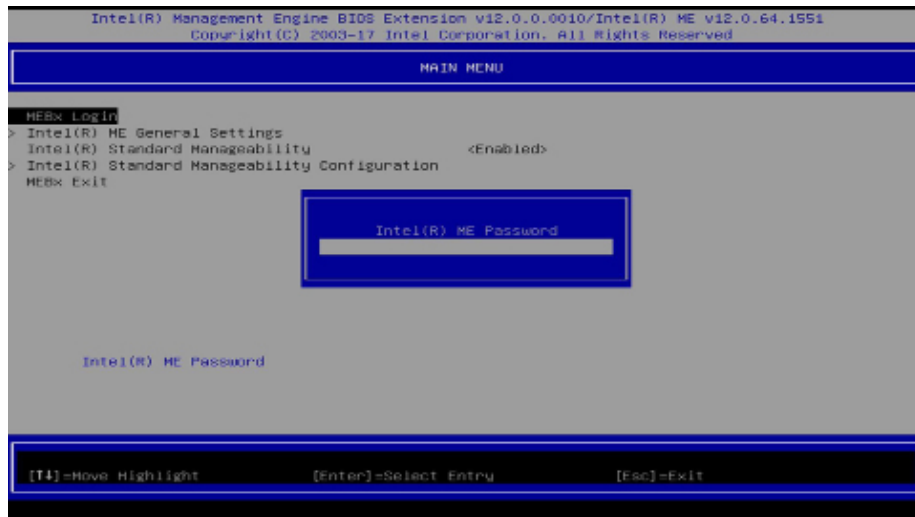

2. Enter a new password and then press Enter. The password must include
 - 8-32 characters;
 - Strong 7-bit ASCII characters excluding : , and " characters;
 - At least one digit character (0, 1, ...9);
 - At least one 7-bit ASCII non alpha-numeric character, above 0x20, (e.g. !, \$, ,);
 - At least one lower case and one upper case characters.
3. Enter the new password again to verify the new password.

Intel(R) ME General Settings

Select **Intel(R) ME General Settings** under Main Menu and then press Enter.

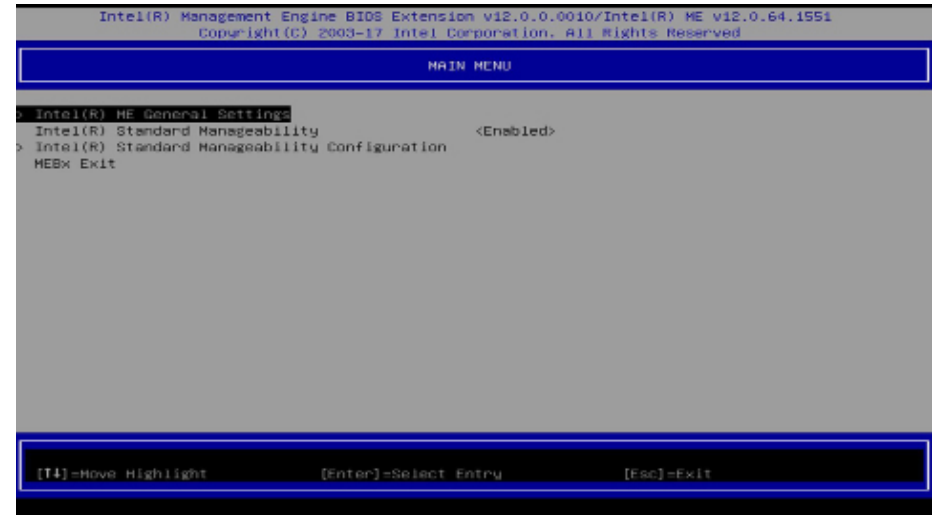

Change ME Password

If you want to change ME password, select **Change ME Password** and then press Enter. A prompt that requires password input will show up.

1. Enter the current password and then press Enter.

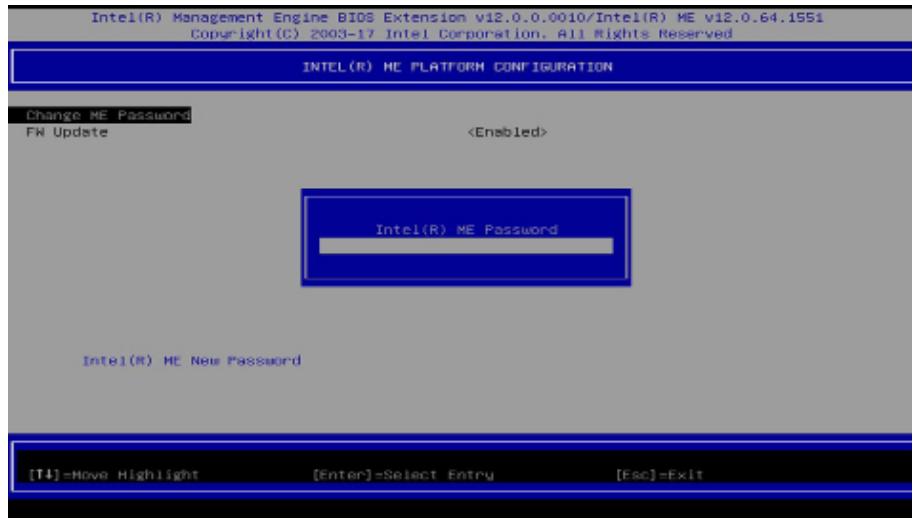

2. Enter a new password and then press Enter. The password must include

- 8-32 characters;
- Strong 7-bit ASCII characters excluding : , and " characters;
- At least one digit character (0, 1, ...,9);
- At least one 7-bit ASCII non alpha-numeric character, above 0x20, (e.g. !, \$, ,);
- At least one lower case and one upper case characters.

3. Enter the new password again to verify the new password.

Local FW Update

Select **Local FW Update** then press Enter. Select **Enabled** or **Disabled** or **Password Protected** then press Enter.

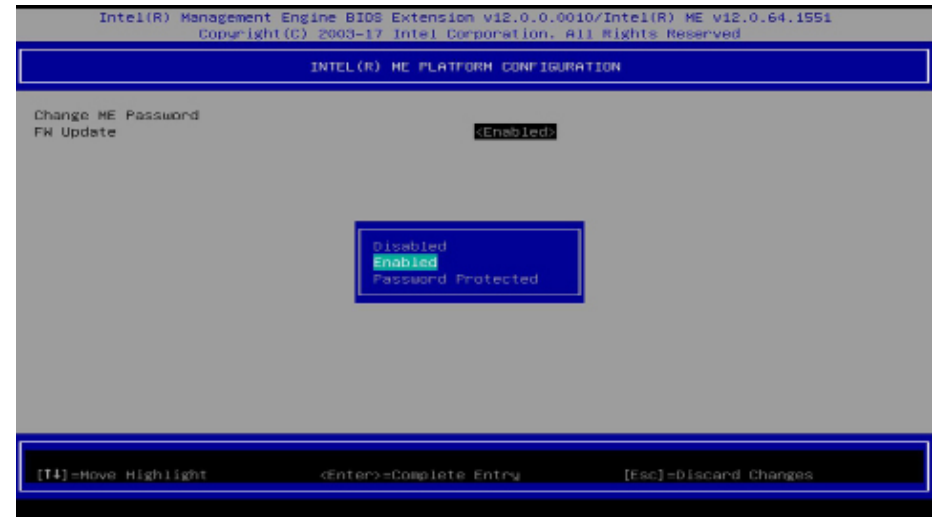

► MEBX

Intel(R) Standard Manageability

Enable Intel(R) Standard Manageability under Main Menu to show relevant options.

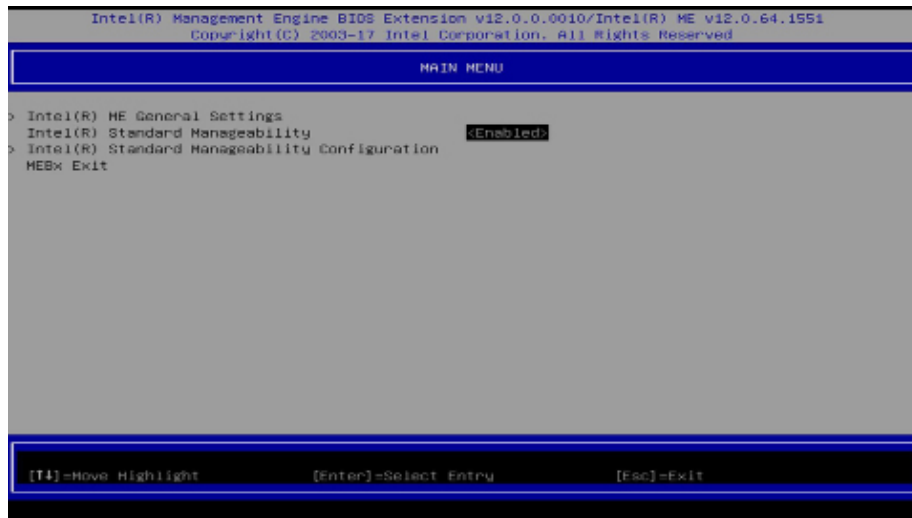

Manageability Feature Selection

Select **Enabled** or **Disabled** then press Enter. When disabled, all the following fields will be hidden. After disabling the field, system restart is required.

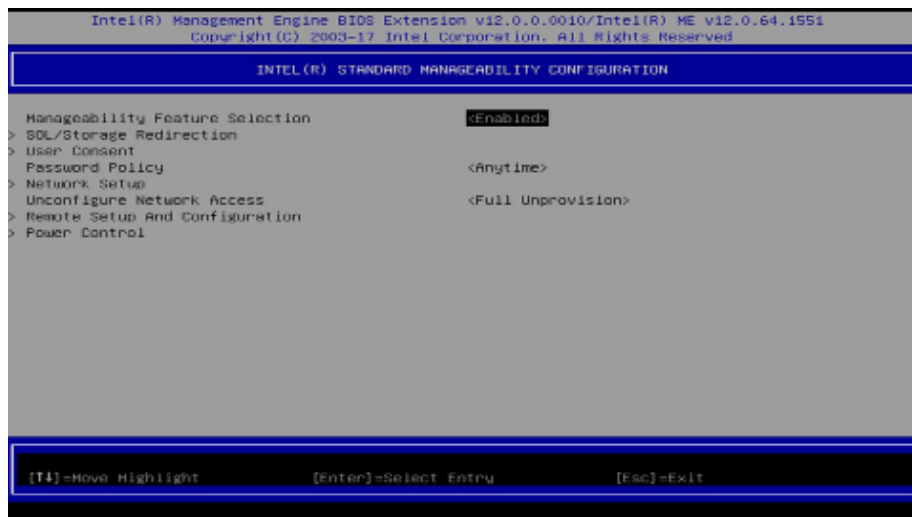

> SOL/Storage Redirection/KVM

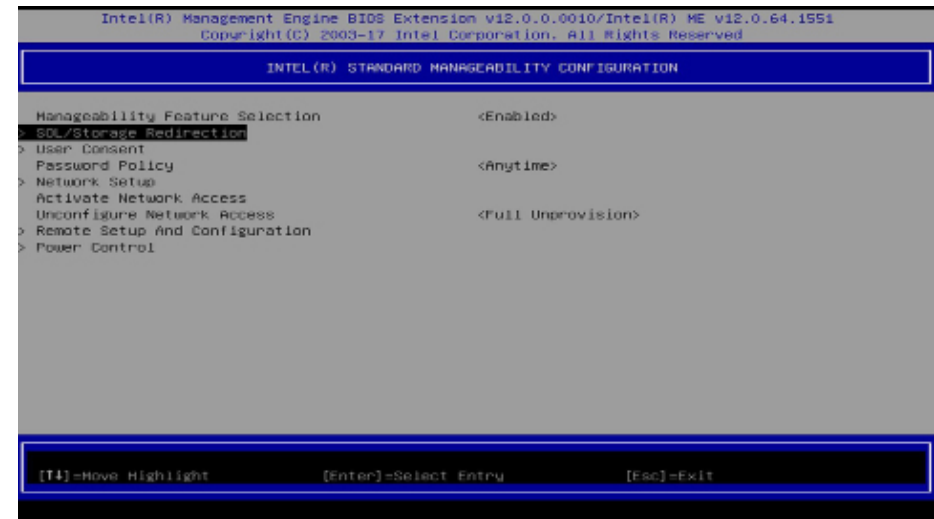

Press Enter to enter the submenu.

> SOL/Storage Redirection/KVM

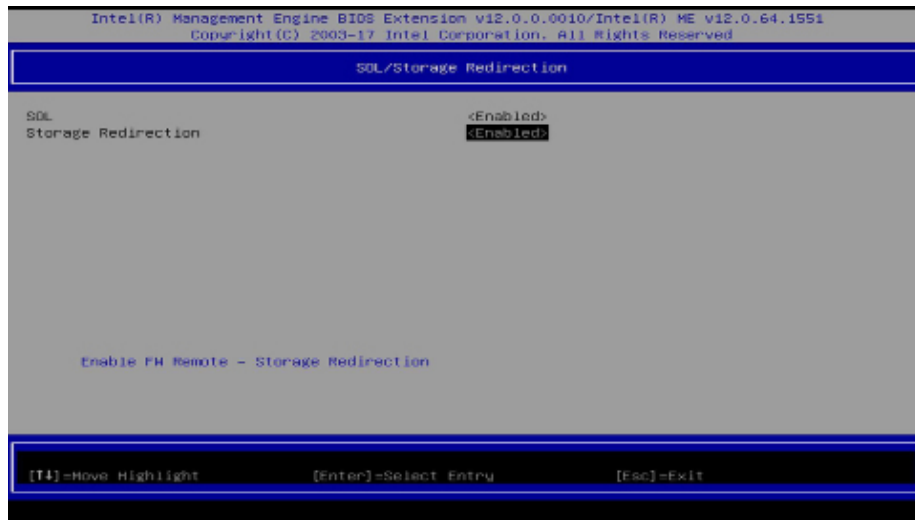

Move the cursor to select a field and press Enter to display options.

SOL

Select Enabled or Disabled then press Enter.

Storage Redirection

Select Enabled or Disabled then press Enter.

> User Consent

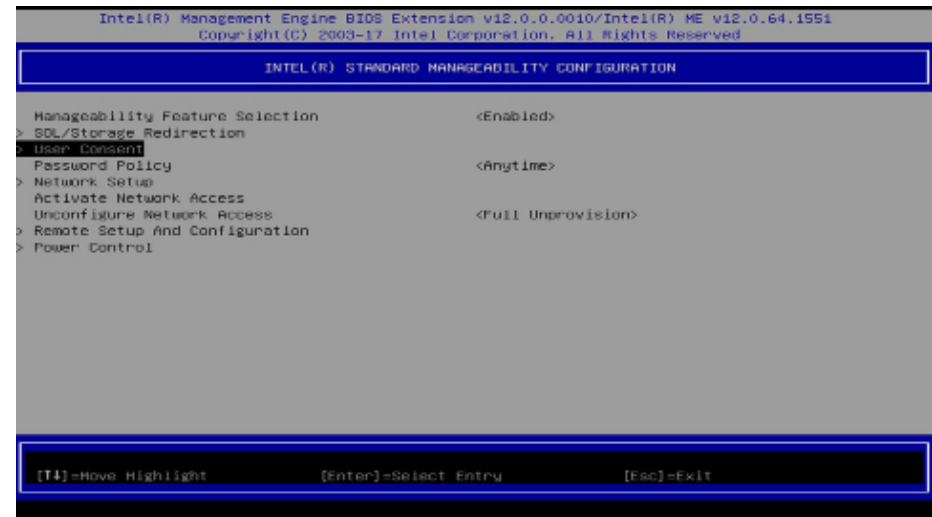

Press Enter to enter the submenu.

> User Consent

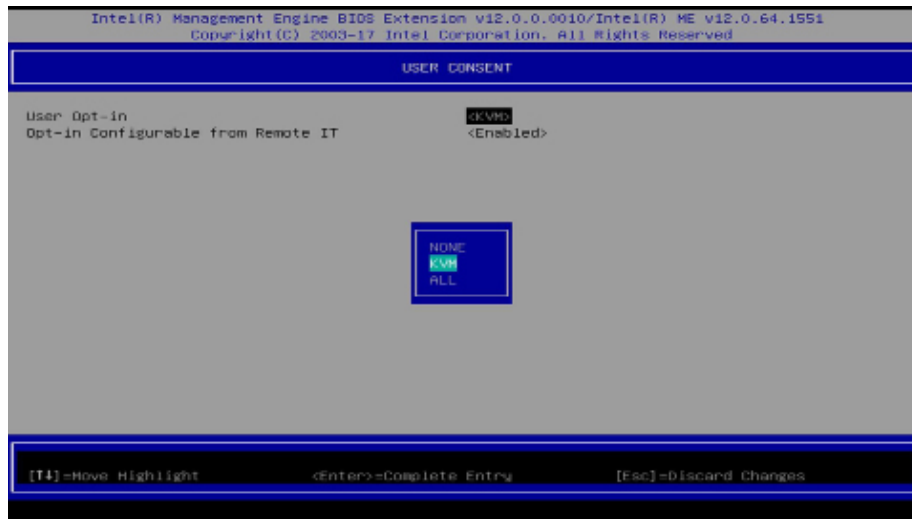

Move the cursor to select a field and press Enter to display options.

User Opt-in

Select **NONE** or **KVM** or **ALL** then press Enter.

Opt-in Configurable from Remote IT

Select **Enabled** or **Disabled** then press Enter.

Password Policy

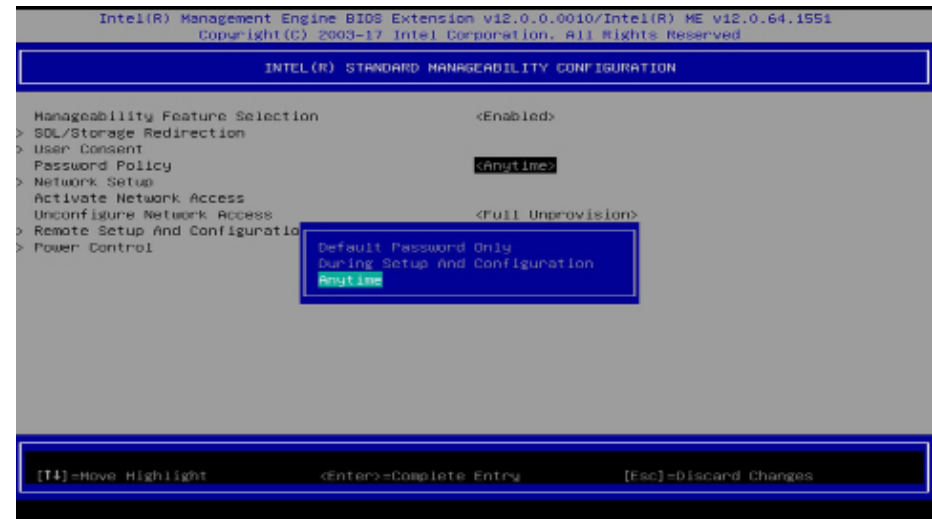

Under the **Intel(R) Standard Manageability Configuration** menu, select **Password Policy** then press Enter. You may choose to use a password only during setup and configuration or to use a password anytime the system is being accessed.

> **Network Setup**

Under the **Intel(R) Standard Manageability Configuration** menu, select **Network Setup** and then press Enter.

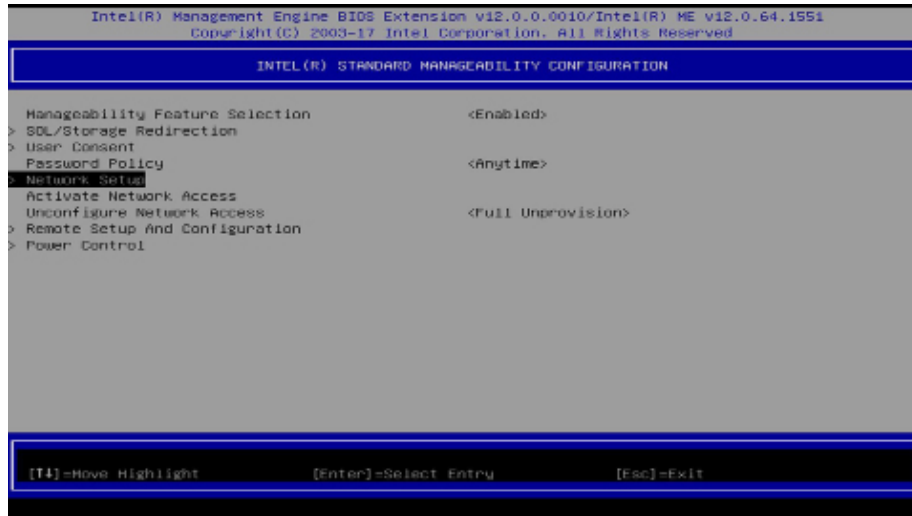

> **Intel(R) ME Network Name Settings**

Under the **Intel(R) ME Network Setup** menu, select **Intel(R) ME Network Name Settings** and then press Enter.

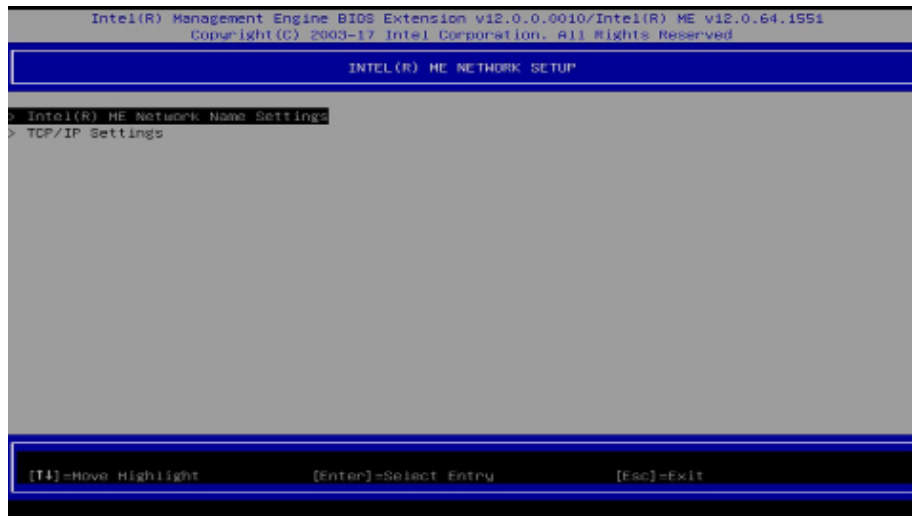

Move the cursor to select a field and press Enter to display options.

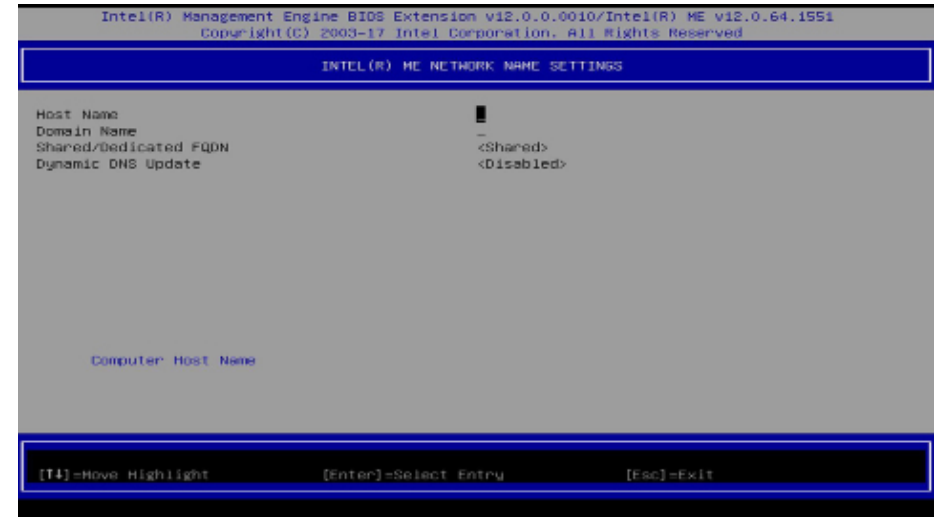

Host Name

Enter the computer's host name and then press Enter.

Domain Name

Enter the computer's domain name and then press Enter.

Shared/Dedicated FQDN

Select **Shared** or **Dedicated** and then press Enter.

Dynamic DNS Update

Select **Enabled** or **Disabled** then press Enter. When **Dynamic DNS Update** is **Enabled**, the following fields will show up.

► MEBX ► Intel(R) Standard Manageability Configuration ► Network Setup
► Intel(R) ME Network Name Settings

> TCP/IP Settings

Under the Intel(R) ME Network Setup menu, select TCP/IP Settings and then press Enter.

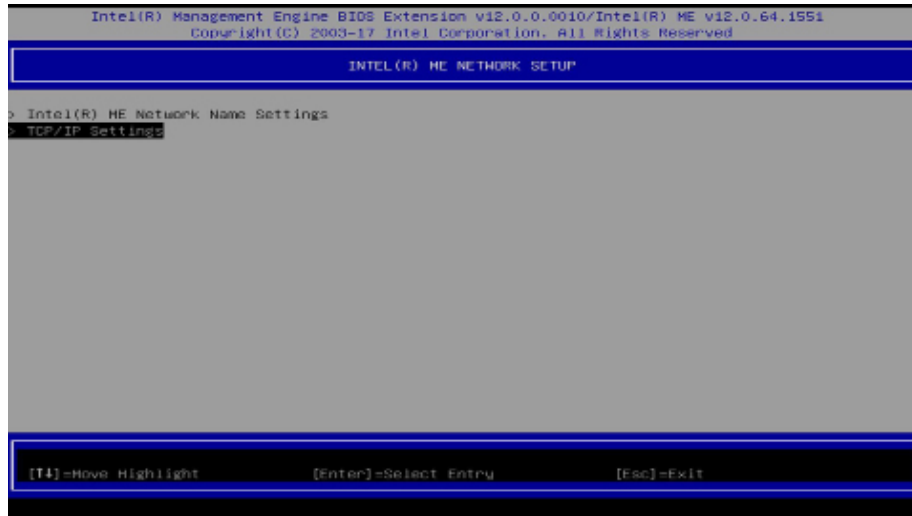

> Wired LAN IPv4 Configuration

Under TCP/IP Settings, select Wired LAN IPv4 Configuration and then press Enter.

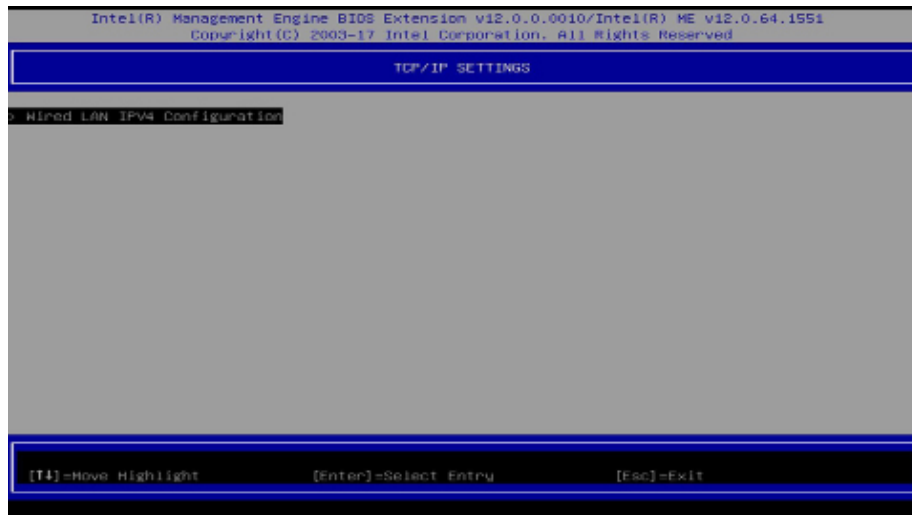

► MEBX ► Intel(R) Standard Manageability Configuration ► Network Setup

DHCP Mode

Select **Enabled** or **Disabled** then press Enter. Please make sure there is a DHCP server in the network when this field is enabled.

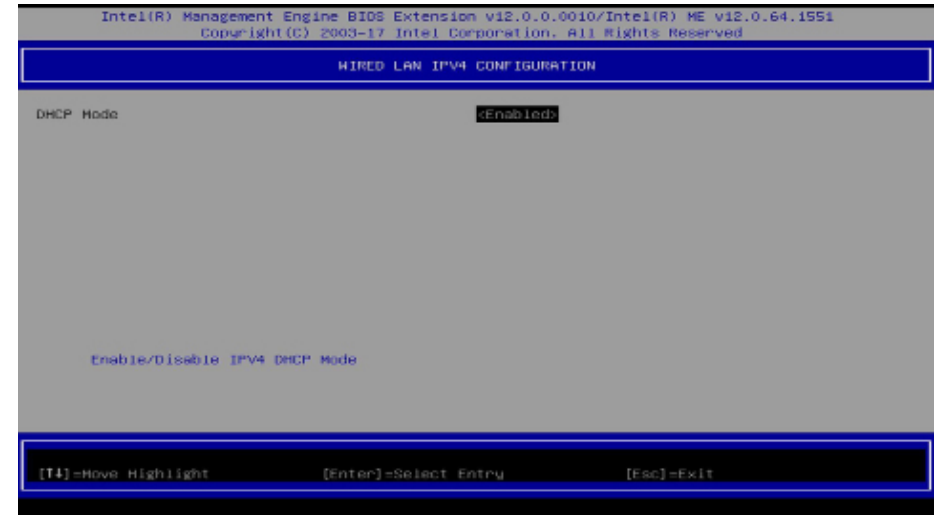

When DHCP is **Disabled**, please manually input a static route by configuring the fields as shown below.

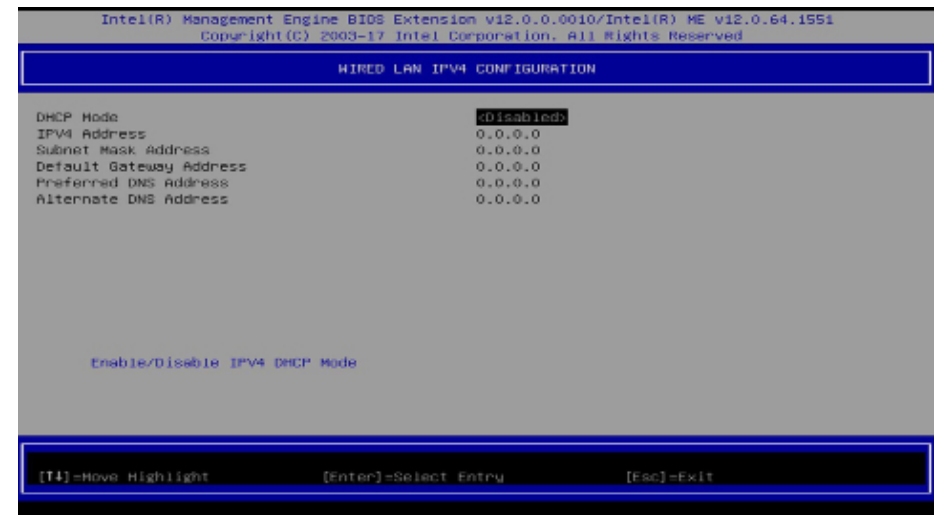

IPv4 Address

Assign a valid and available IP address to the system. Insert a value from 0.0.0.0 to 255.255.255.255 in IPv4 format.

Subnet Mask Address

Insert a value from 0.0.0.0 to 255.255.255.255 in IPv4 format.

Default Gateway Address

Insert a value from 0.0.0.0 to 255.255.255.255 in IPv4 format.

Preferred DNS Address

Insert a value from 0.0.0.0 to 255.255.255.255 in IPv4 format.

Alternate DNS Address

Insert a value from 0.0.0.0 to 255.255.255.255 in IPv4 format.

Activate Network Access

Select **Activate Network Access** and press Enter, and then press Y to activate the ME network connection with the settings configured previously, or press N to abort.

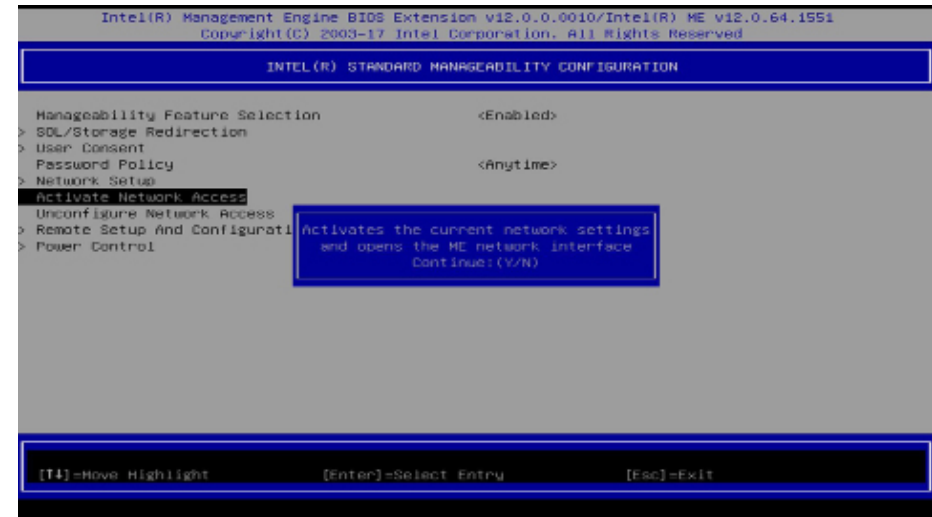

Unconfigure Network Access

Under the **Intel(R) Standard Manageability Configuration** menu, select **Unconfigure Network Access** and press Enter, and then press Enter to fully deactivate the ME network connection and reset configuration to factory default. Press Y to confirm or N to abort.

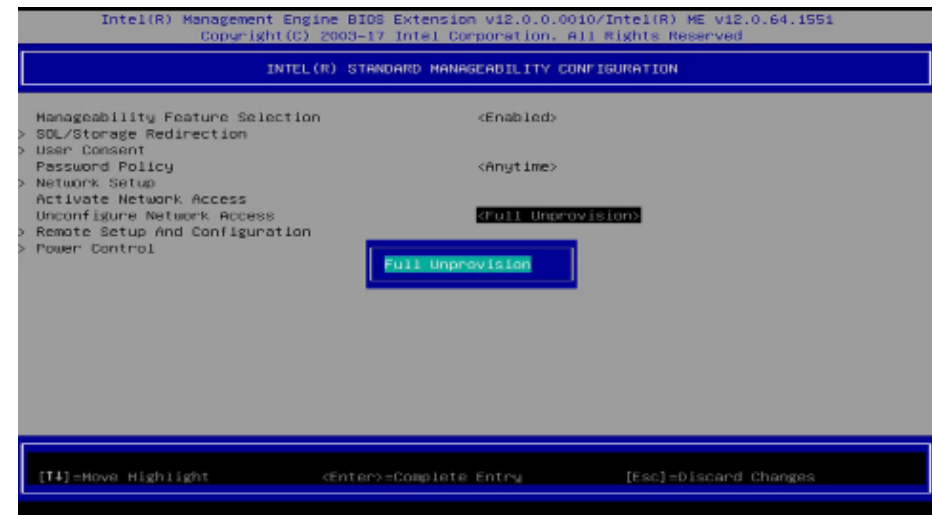

> **Remote Setup And Configuration**

Under the **Intel(R) Standard Manageability Configuration** menu, select **Remote Setup And Configuration** then press Enter.

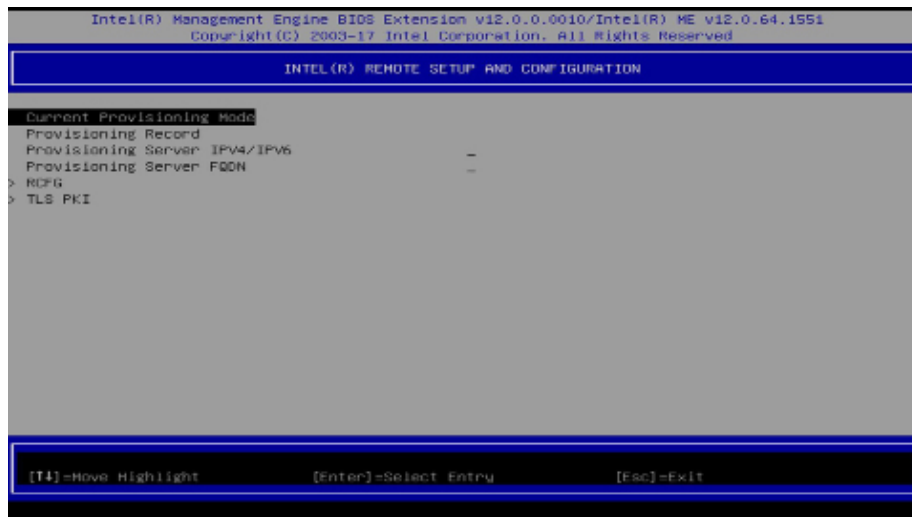
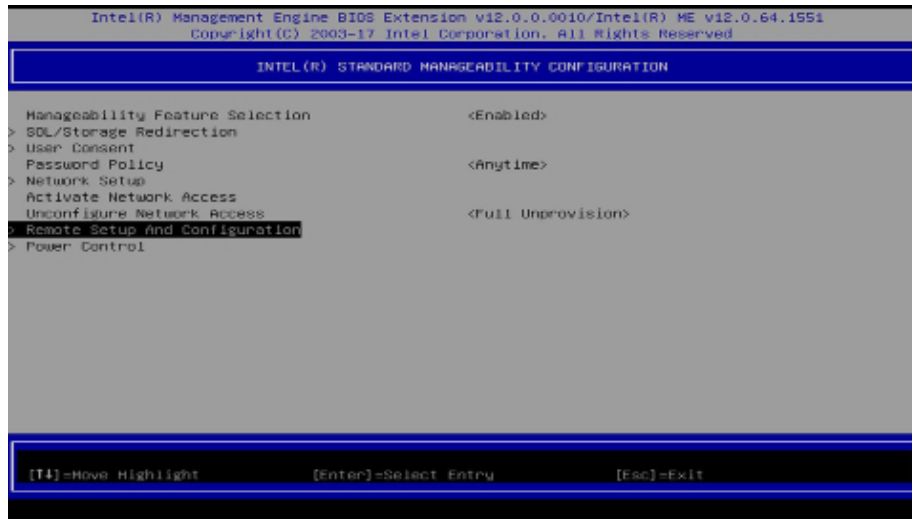

Current Provisioning Mode

The current mode – Public Key Infrastructure (PKI) – is displayed.

Provisioning Record

Press Enter to view the record.

Provisioning Server IPV4/IPV6

Enter the address of the server then press Enter, and then insert the TCP/UDP port number.

Provisioning Server FQDN

Enter the Fully Qualified Domain Name (FQDN) of the server and then press Enter.

> **RCFG**

Press Enter, select **Start Configuration**, and then press Enter to activate Remote Configuration (RCFG). Press Y to confirm or N to abort.

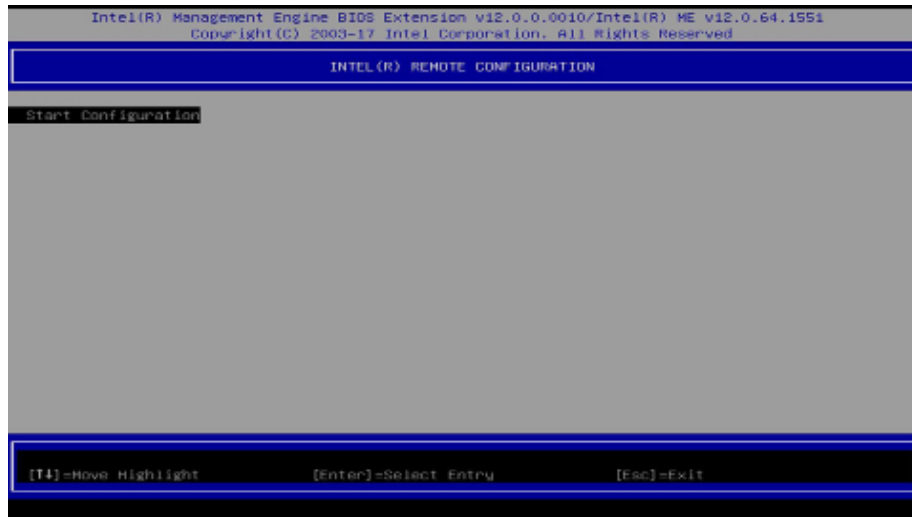

> **TLS PKI**

The system adopts PKI for encryption and authentication, and the TLS protocol for communication security to ensure remote configuration safety.

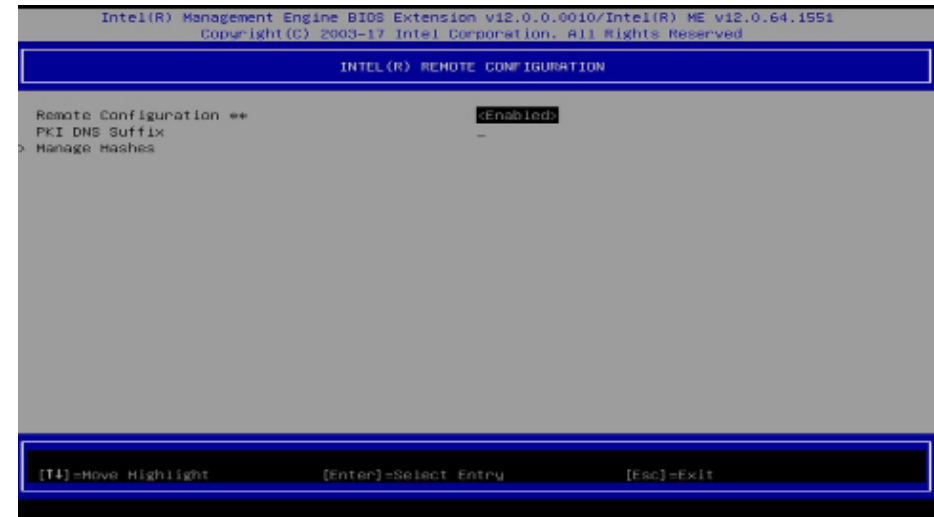

Remote Configuration **

Select **Enabled** or **Disabled** then press Enter.

PKI DNS Suffix

Specify the DNS Suffix of the PKI server, and then press Enter.

> Manage Hashes

Select a hash name and then press the following keys to execute a function.

- Insert – enter a custom hash certificate name,
- Delete – delete a hash
- Enter – view hash information
- + – activate or deactivate a hash
- Esc – exit

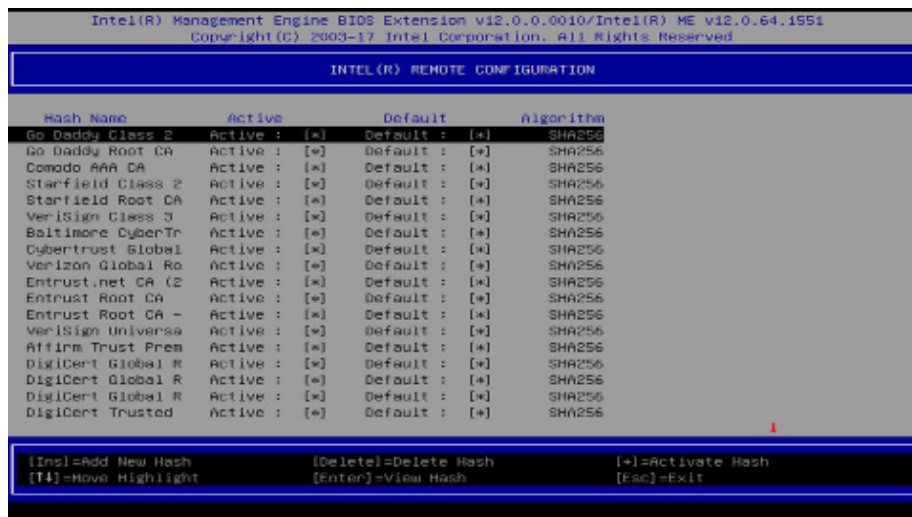

> Power Control

Under the Intel(R) Standard Manageability Configuration menu, select Power Control then press Enter.

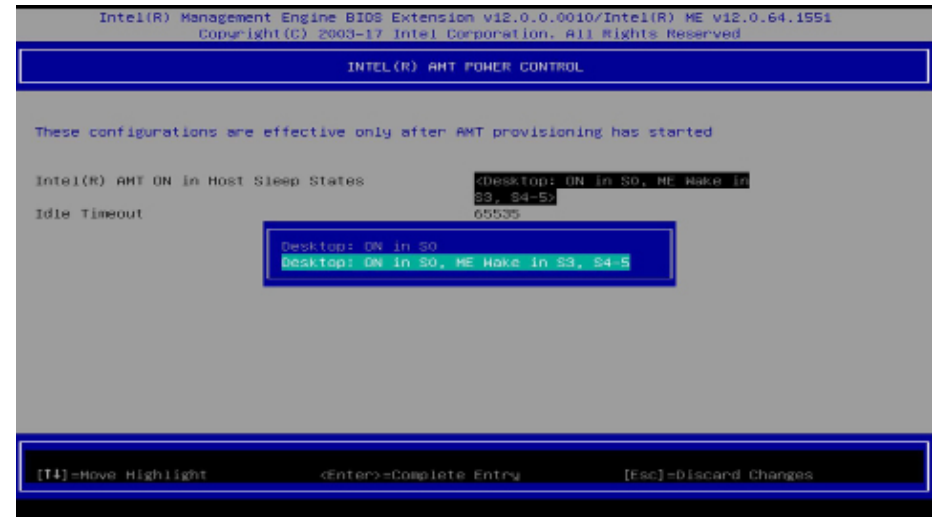

Intel(R) AMT ON in Host Sleep States

Select an option and then press Enter.

Idle Timeout

Enter a timeout value and press Enter.

► MEBX

MEBx Exit

Under the Main Menu, select MEBx Exit and then press Enter. Press Y to confirm or N to abort.

