

BW051

Embedded SBC 2.5"

User's Manual

Copyright

This publication contains information that is protected by copyright. No part of it may be reproduced in any form or by any means or used to make any transformation/adaptation without the prior written permission from the copyright holders.

This publication is provided for informational purposes only. The manufacturer makes no representations or warranties with respect to the contents or use of this manual and specifically disclaims any express or implied warranties of merchantability or fitness for any particular purpose. The user will assume the entire risk of the use or the results of the use of this document. Further, the manufacturer reserves the right to revise this publication and make changes to its contents at any time, without obligation to notify any person or entity of such revisions or changes.

Changes after the publication's first release will be based on the product's revision. The website will always provide the most updated information.

© 2017. All Rights Reserved.

Trademarks

Product names or trademarks appearing in this manual are for identification purpose only and are the properties of the respective owners.

FCC and DOC Statement on Class B

This equipment has been tested and found to comply with the limits for a Class B digital device, pursuant to Part 15 of the FCC rules. These limits are designed to provide reasonable protection against harmful interference when the equipment is operated in a residential installation. This equipment generates, uses and can radiate radio frequency energy and, if not installed and used in accordance with the instruction manual, may cause harmful interference to radio communications. However, there is no guarantee that interference will not occur in a particular installation. If this equipment does cause harmful interference to radio or television reception, which can be determined by turning the equipment off and on, the user is encouraged to try to correct the interference by one or more of the following measures:

- Reorient or relocate the receiving antenna.
- Increase the separation between the equipment and the receiver.
- Connect the equipment into an outlet on a circuit different from that to which the receiver is connected.
- Consult the dealer or an experienced radio TV technician for help.

Notice:

1. The changes or modifications not expressly approved by the party responsible for compliance could void the user's authority to operate the equipment.
2. Shielded interface cables must be used in order to comply with the emission limits.

Table of Contents

Copyright.....	2
Trademarks.....	2
FCC and DOC Statement on Class B.....	2
About this Manual	4
Warranty.....	4
Static Electricity Precautions.....	4
Safety Measures.....	4
About the Package	5
Optional Items.....	5
Before Using the System Board.....	5
Chapter 1 - Introduction.....	6
Specifications	6
Features	7
Chapter 2 - Hardware Installation.....	8
Board Layout.....	8
Block Diagram.....	9
Mechanical Diagram.....	9
System Memory.....	10
Jumper Settings.....	10
Auto Power-on Select & Panel Power Select	10
Rear Panel I/O Ports.....	11
12V DC-in	11
Graphics Interfaces.....	12
RJ45 LAN Ports	12
USB Ports.....	13
I/O Connectors	14

Digital I/O Connector	14
Front Audio Connector	14
COM (Serial) Ports.....	15
Front Panel Connector.....	15
SATA (Serial ATA) Connector.....	16
Expansion Slot	16
E I/O Connector	17
LVDS LCD Panel Connector	18
LCD/Inverter Power Connector	18
LVDS LCD Panel Connector	18
LCD/Inverter Power Connector	18
SMBus Connector	19

Chapter 3 - BIOS Setup.....20

Overview	20
Insyde BIOS Setup Utility.....	21
Main	21
Advanced	21
Security	29
Boot	29
Exit.....	30
Updating the BIOS.....	30
Notice: BIOS SPI ROM.....	31

Chapter 4 - Supported Software.....32

Appendix A - Troubleshooting Checklist.....44

About this Manual

An electronic file of this manual is included in the DVD. To view the user's manual in the DVD, insert the DVD into a DVD-ROM drive. The autorun screen (Main Board Utility DVD) will appear. Click "User's Manual" on the main menu.

Warranty

1. Warranty does not cover damages or failures that arised from misuse of the product, inability to use the product, unauthorized replacement or alteration of components and product specifications.
2. The warranty is void if the product has been subjected to physical abuse, improper installation, modification, accidents or unauthorized repair of the product.
3. Unless otherwise instructed in this user's manual, the user may not, under any circumstances, attempt to perform service, adjustments or repairs on the product, whether in or out of warranty. It must be returned to the purchase point, factory or authorized service agency for all such work.
4. We will not be liable for any indirect, special, incidental or consequential damages to the product that has been modified or altered.

Static Electricity Precautions

It is quite easy to inadvertently damage your PC, system board, components or devices even before installing them in your system unit. Static electrical discharge can damage computer components without causing any signs of physical damage. You must take extra care in handling them to ensure against electrostatic build-up.

1. To prevent electrostatic build-up, leave the system board in its anti-static bag until you are ready to install it.
2. Wear an antistatic wrist strap.
3. Do all preparation work on a static-free surface.
4. Hold the device only by its edges. Be careful not to touch any of the components, contacts or connections.
5. Avoid touching the pins or contacts on all modules and connectors. Hold modules or connectors by their ends.



Important:

Electrostatic discharge (ESD) can damage your processor, disk drive and other components. Perform the upgrade instruction procedures described at an ESD workstation only. If such a station is not available, you can provide some ESD protection by wearing an antistatic wrist strap and attaching it to a metal part of the system chassis. If a wrist strap is unavailable, establish and maintain contact with the system chassis throughout any procedures requiring ESD protection.

Safety Measures

To avoid damage to the system:

- Use the correct AC input voltage range.

To reduce the risk of electric shock:

- Unplug the power cord before removing the system chassis cover for installation or servicing. After installation or servicing, cover the system chassis before plugging the power cord.

About the Package

The package contains the following items. If any of these items are missing or damaged, please contact your dealer or sales representative for assistance.

- One BW051 board
- One COM port cable
- One Serial ATA data cable
- One Y cable for SATA and inverter power
- One DVD
- One QR (Quick Reference)
- One Heat sink

Optional Items

- USB port cable
- Power adapter (60W, 12V)
- Power adapter (120W, 12V)
- Heat spreader
- Audio cable

The board and accessories in the package may not come similar to the information listed above. This may differ in accordance to the sales region or models in which it was sold. For more information about the standard package in your region, please contact your dealer or sales representative.

Before Using the System Board

Before using the system board, prepare basic system components.

If you are installing the system board in a new system, you will need at least the following internal components.

- Storage devices such as hard disk drive, DVD-ROM, etc.

You will also need external system peripherals you intend to use which will normally include at least a keyboard, a mouse and a video display monitor.

Chapter 1 - Introduction

Specifications

SYSTEM	Processor	Intel® Pentium®/Celeron® Processor N3000 Family, BGA 1170 (*) Intel® Atom™ Processor x5-E8000, Quad Core, 2M Cache, 1.04GHz, 5W Intel® Pentium® Processor N3710, Quad Core, 2M Cache, 1.6GHz (2.56GHz), 6W Intel® Celeron® Processor N3160, Quad Core, 2M Cache, 1.6GHz (2.24GHz), 6W Intel® Celeron® Processor N3060, Dual Core, 2M Cache, 1.6GHz (2.48GHz), 6W Intel® Celeron® Processor N3010, Dual Core, 2M Cache, 1.04GHz (2.24GHz), 4W
	Memory	One 204-pin SODIMM up to 8GB Single Channel DDR3L 1600MHz
	BIOS	Insyde SPI 64Mbit
GRAPHICS	Controller	Intel® HD Graphics
	Feature	OpenGL 4.2, Direct X 11.1, OpenCL 1.2, OGL ES 3.0 HW Decode: H.264, MPEG2, VC1, VP8, H.265, MPEG4 HW Encode: H.264, MPEG2, MPEG4
	Display	1 x VGA/HDMI (HDMI available upon request) 1 x LVDS VGA: resolution up to 1920x1200 @ 60Hz HDMI: resolution up to 1920x1080 @ 60Hz LVDS: single channel 24-bit, resolution up to 1366x768 @ 60Hz
	Dual Displays	VGA + LVDS HDMI + LVDS
EXPANSION	Interface	1 x Half-size mSATA (SATA) 1 x Full-size Mini PCIe (PCIe/USB)
AUDIO	Audio Codec	Realtek ALC888S-VD2-GR
ETHERNET	Controller	1 x Intel® I211AT PCIe (10/100/1000Mbps)
REAR I/O	Ethernet	1 x GbE (RJ-45)
	USB	2 x USB 3.0
	Display	1 x VGA/HDMI (HDMI available upon request)
INTERNAL I/O	Serial	1 x RS-232/422/485 (2.0mm pitch, right angle type) 1 x RS-232 (2.0mm pitch, right angle type)
	USB	2 x USB 2.0 (2.0mm pitch)
	Display	1 x LVDS LCD Panel Connector
	Audio	1 x Audio (Line-out/Mic-in)
	SATA	1 x SATA 3.0 (up to 6Gb/s)
	DIO	1 x 8-bit DIO
	SMBus	1 x SMBus
WATCHDOG TIMER	Output & Interval	System Reset, Programmable via Software from 1 to 255 Seconds
SECURITY	TPM	Available Upon Request

POWER	Type	Single 12V +/-10% DC
	Connector	2-pin Terminal Block
	Consumption	BW051 Typical: N3710:12V @ 0.47A (5.64Watt) Max.: N3710:12V @ 1.0864A (13.037Watt)
	RTC Battery	Lithium 3V (210mAH)
OS SUPPORT	Microsoft/Linux	Windows 7 (/WES7) 32/64-bit Windows 8.1 (64-bit) Windows 10 IoT Enterprise 32/64-bit Debian 8 (with VESA graphic driver) CentOS 7 (with VESA graphic driver) Ubuntu 15.10 (Intel graphic driver available)
ENVIRONMENT	Temperature	Operating: 0 to 60°C Storage: -40 to 85°C
	Humidity	Operating: 5 to 90% RH Storage: 5 to 90% RH
MECHANICAL	Dimensions	2.5" Pico-ITX Form Factor 100mm (3.94") x 72mm (2.83")
	Height	PCB: 1.6mm Top Side: 15.5mm, Bottom Side: 8.0mm

*When PXE function is used with the UEFI boot type, the client screen might display partial screen if the PXE server employs a graphical user interface (GUI)-based management interface. This problem is due to resolution compatibility between the server and the client.

Features

● Watchdog Timer

The Watchdog Timer function allows your application to regularly “clear” the system at the set time interval. If the system hangs or fails to function, it will reset at the set time interval so that your system will continue to operate.

● DDR3L

DDR3L SDRAM provides backward compatibility to DDR3 memory modules but can operate at the same or at a lower power level.

● Graphics

The integrated Intel® HD graphics engine delivers an excellent blend of graphics performance and features to meet business needs. It provides excellent video and 3D graphics with outstanding graphics responsiveness. These enhancements deliver the performance and compatibility needed for today's and tomorrow's business applications. Supports 1 x VGA/HDMI and 1 x LVDS interfaces for display outputs.

● Serial ATA

Serial ATA is a storage interface that is compliant with SATA 1.0a specification. With speed of up to 3Gb/s (SATA 2.0), it improves hard drive performance faster than the standard parallel ATA whose data transfer rate is 100MB/s.

● Gigabit LAN

Two Intel® I211AT PCI Express Gigabit Ethernet controllers support up to 1Gbps data transmission.

● Audio

The Realtek ALC888S-VD2-GR audio codec provides 2.1-channel High Definition audio output.

● Power Failure Recovery

When power returns after an AC power failure, you may choose to either power-on the system manually or let the system power-on automatically.

● USB

The system board supports the new USB 3.0. It is capable of running at a maximum transmission speed of up to 5 Gbit/s (625 MB/s) and is faster than USB 2.0 (480 Mbit/s, or 60 MB/s) and USB 1.1 (12Mb/s). USB 3.0 reduces the time required for data transmission, reduces power consumption, and is backward compatible with USB 2.0. It is a marked improvement in device transfer speeds between your computer and a wide range of simultaneously accessible external Plug and Play peripherals.

● Wake-On-LAN

This feature allows the network to remotely wake up a Soft Power Down (Soft-Off) PC. It is supported via the onboard LAN port or via a PCI LAN card that uses the PCI PME (Power Management Event) signal. However, if your system is in the Suspend mode, you can power-on the system only through an IRQ or DMA interrupt.



Important:

The 5V_standby power source of your power supply must support $\geq 720\text{mA}$.

● Wake-On-USB (Optional)

This function allows you to use a USB keyboard or USB mouse to wake up a system from the S3 (STR - Suspend To RAM) state.



Important:

If you are using the Wake-On-USB Keyboard/Mouse function for 2 USB ports, the 5V_standby power source of your power supply must support $\geq 1.5\text{A}$. For 3 or more USB ports, the 5V_standby power source of your power supply must support $\geq 2\text{A}$.

● ACPI STR

The system board is designed to meet the ACPI (Advanced Configuration and Power Interface) specification. ACPI has energy saving features that enable PCs to implement power management and plug-and-play with operating systems that support power management features.

With ACPI, the system can further utilize the Ethernet adapter's wake-on-LAN (WOL) capability that enables remote wake-up if the Ethernet adapter supports such feature.



Important:

The 5V_standby power source of your power supply must support $\geq 720\text{mA}$.

● RTC Timer

The RTC installed on the system board allows your system to automatically power-on on the set date and time.

Chapter 2 - Hardware Installation

Board Layout

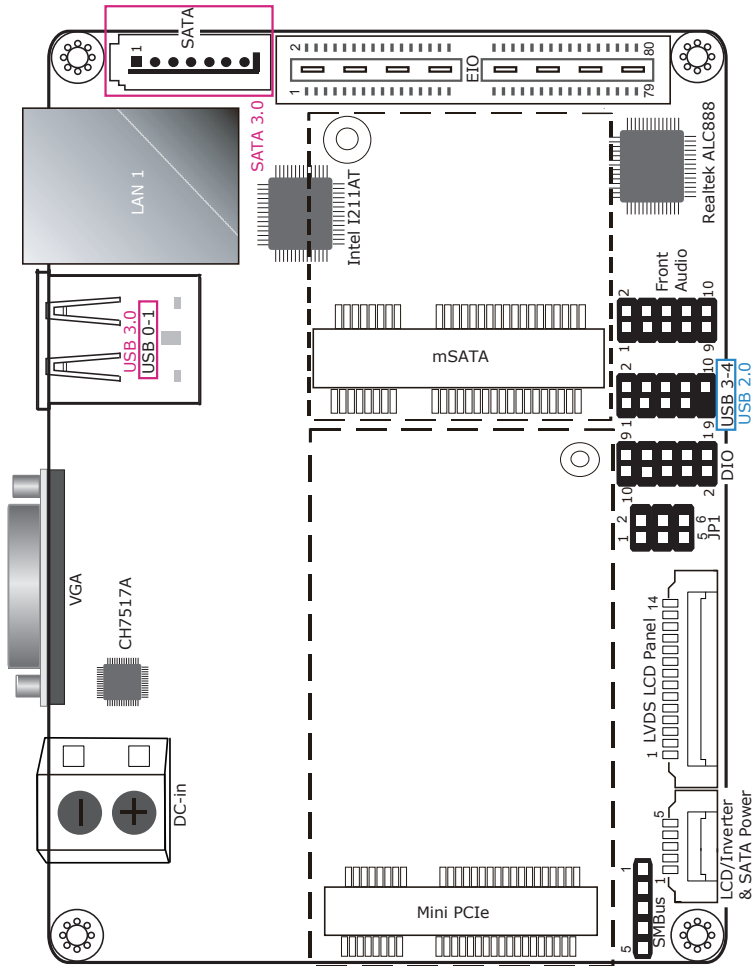

Top View

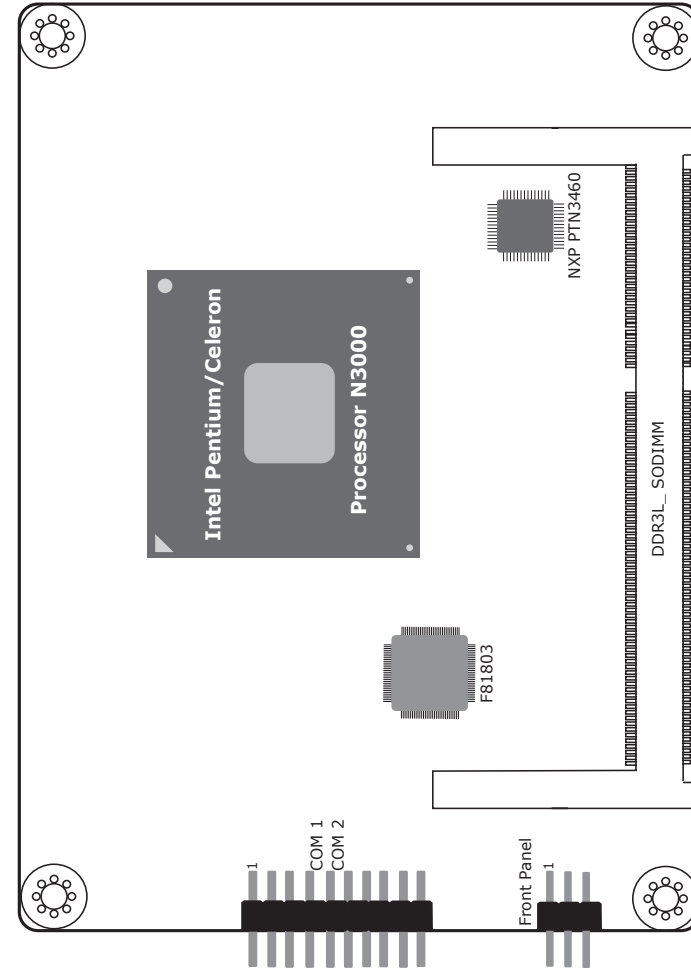

Bottom View

Block Diagram

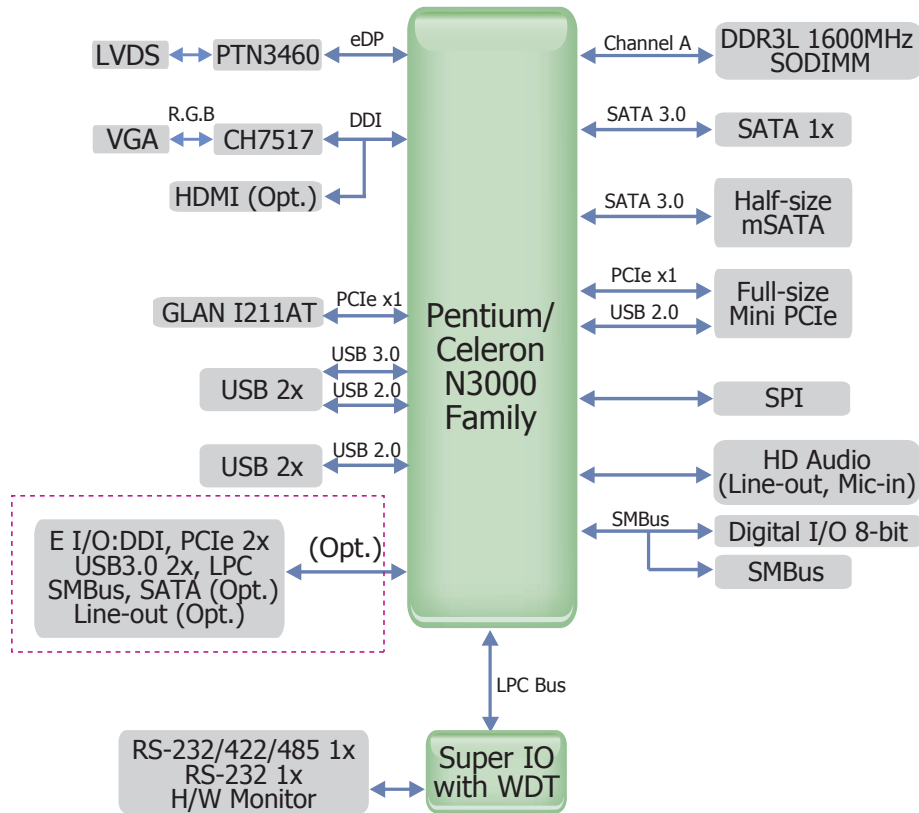

Mechanical Diagram

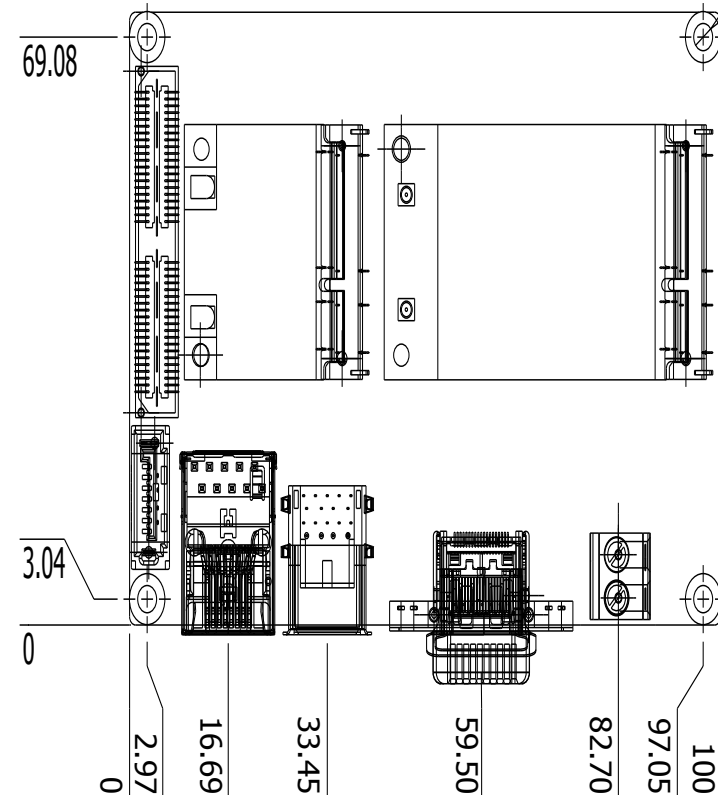



Important:

Electrostatic discharge (ESD) can damage your board, processor, disk drives, add-in boards, and other components. Perform installation procedures at an ESD workstation only. If such a station is not available, you can provide some ESD protection by wearing an antistatic wrist strap and attaching it to a metal part of the system chassis. If a wrist strap is unavailable, establish and maintain contact with the system chassis throughout any procedures requiring ESD protection.

System Memory



Important:

When the Standby Power LED lights red, it indicates that there is power on the system board. Power-off the PC then unplug the power cord prior to installing any devices. Failure to do so will cause severe damage to the motherboard and components.

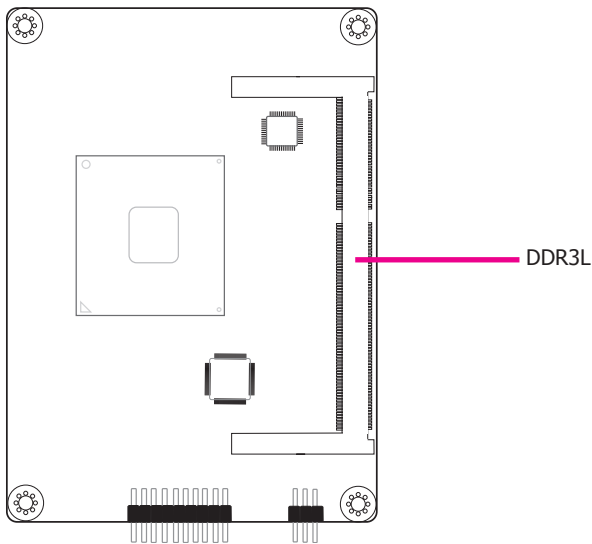

Features

- One 204-pin SODIMM up to 8GB
- Single Channel DDR3L 1600MHz

Jumper Settings

Auto Power-on Select & Panel Power Select

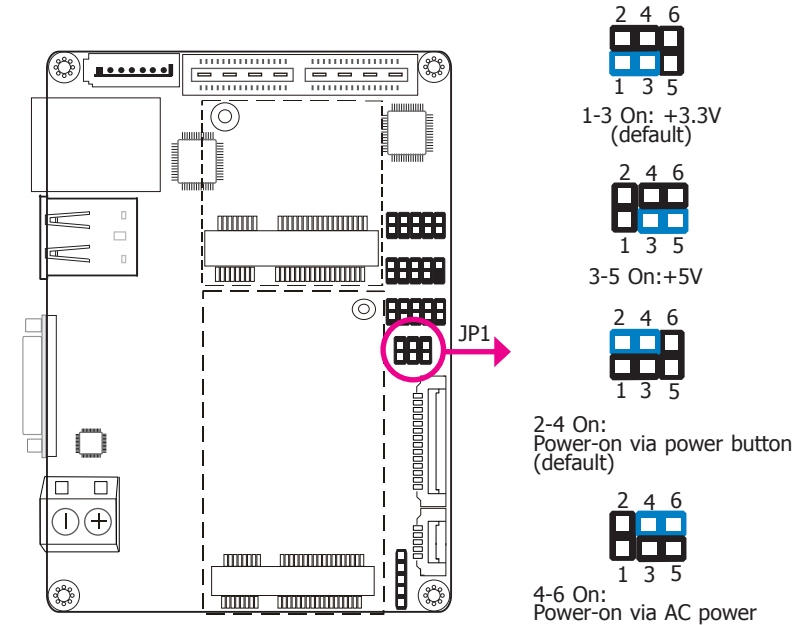

JP1 is used to select the method of powering on the system. If you want the system to power-on whenever AC power comes in, set JP1 pins 4 and 6 to On. If you want to use the power button, set pins 2 and 4 to On.

When using the JP1 "Power On" feature to power the system back on after a power failure occurs, the system may not power on if the power lost is resumed within 5 seconds (power flicker).

JP1 is also used to select the power supplied with the LCD panel.



Important:

Before powering-on the system, make sure that the power settings of JP1 match the LCD panel's specification. Selecting the incorrect voltage will seriously damage the LCD panel.

Rear Panel I/O Ports

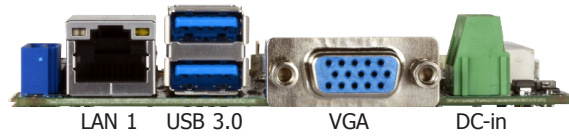

The rear panel I/O consists of the following ports:

- 1 12V DC-in jack
- 1 VGA/HDMI port
- 1 GbE (RJ-45)
- 2 USB 3.0 port

12V DC-in

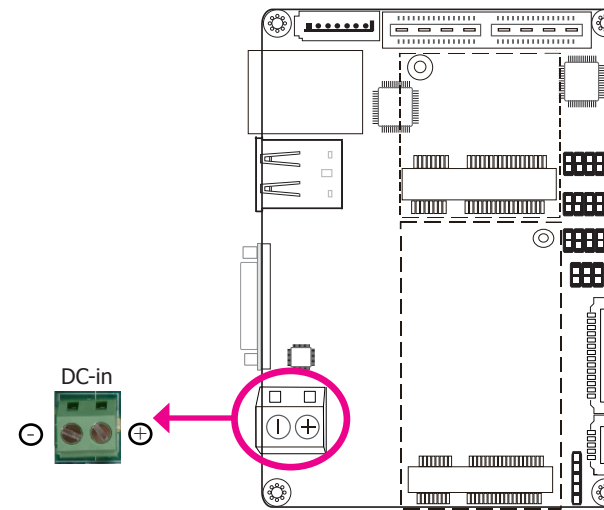

This 2-pin terminal block provides a maximum of 100W/120W power and is considered a low power solution. Connect a DC power cord to this terminal block. Using a voltage more than the recommended range may fail to boot the system or cause damage to the system board.

Graphics Interfaces

The display ports consist of the following:

- 1 VGA port

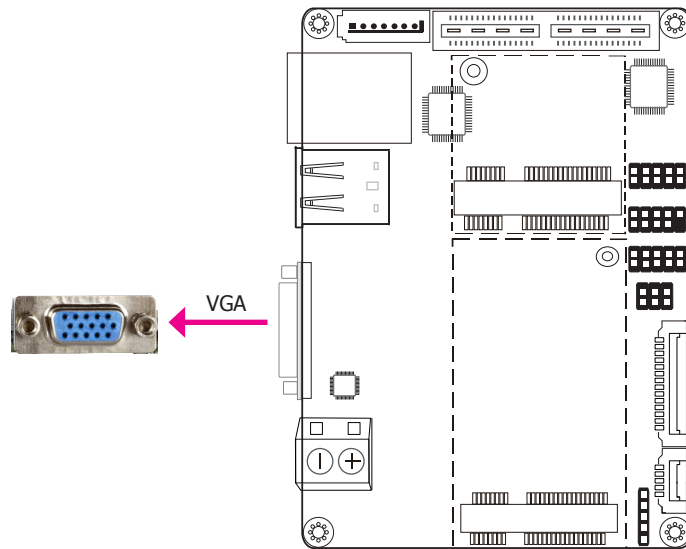

VGA Port

The VGA port is used for connecting a VGA monitor. Connect the monitor's 15-pin D-shell cable connector to the VGA port. After you plug the monitor's cable connector into the VGA port, gently tighten the cable screws to hold the connector in place.

Driver Installation

Install the graphics driver. Refer to Chapter 4 for more information.

RJ45 LAN Ports

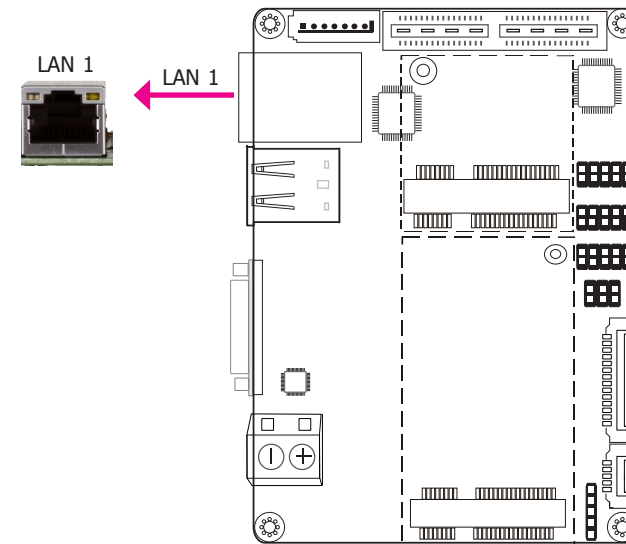

Features

- 1 Intel® I211AT PCI Express Gigabit Ethernet controllers

The LAN ports enable the system board to connect to a local area network by means of a network hub.

BIOS Setting

Configure the onboard LAN in the "ACPI Configuration" submenu of the Advanced menu in the BIOS. Refer to Chapter 3 for more information.

Driver Installation

Install the LAN drivers. Refer to Chapter 4 for more information.

USB Ports

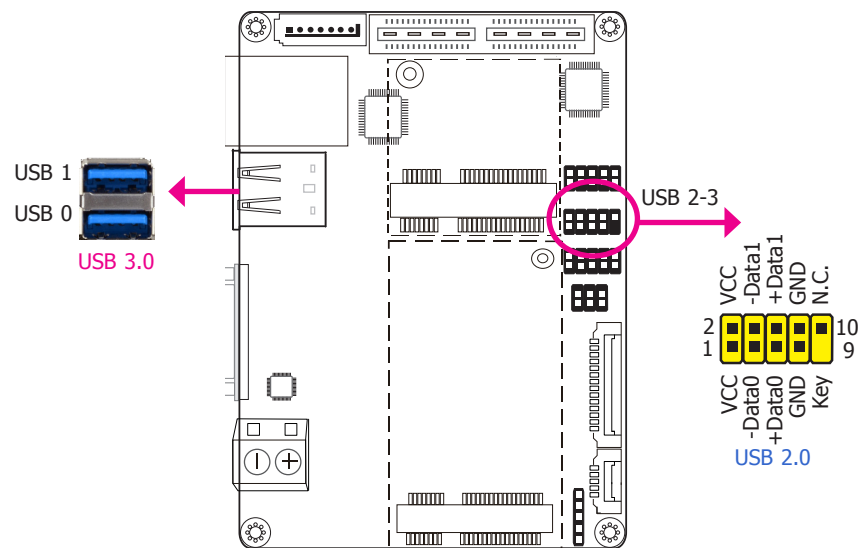

The USB device allows data exchange between your computer and a wide range of simultaneously accessible external Plug and Play peripherals.

The system board is equipped with 2 onboard USB 3.0 ports (USB 0-1). The 10-pin connectors allow you to connect 2 additional USB 2.0 ports (USB 2-3). The additional USB ports may be mounted on a card-edge bracket. Install the card-edge bracket to an available slot at the rear of the system chassis and then insert the USB port cables to a connector.

BIOS Settings

Configure the onboard USB in the "USB Configuration" submenu of the Advanced menu in the BIOS. Refer to Chapter 3 for more information.

Driver Installation

You may need to install the proper driver if you use Windows 7 and 8.1 for the USB 3.0 host controller to work properly. Refer to Chapter 4 for more information.

Wake-On-USB Keyboard/Mouse

The Wake-On-USB Keyboard/Mouse function allows you to use a USB keyboard or USB mouse to wake up a system from the S3 (STR - Suspend To RAM) state.



Important:

1. If you are using the Wake-On-USB Keyboard/Mouse function for 2 USB ports, the +5V_standby power source of your power supply must support $\geq 1.5A$. For 3 or more USB ports, the +5V_standby power source of your power supply must support $\geq 2A$.

I/O Connectors

Digital I/O Connector

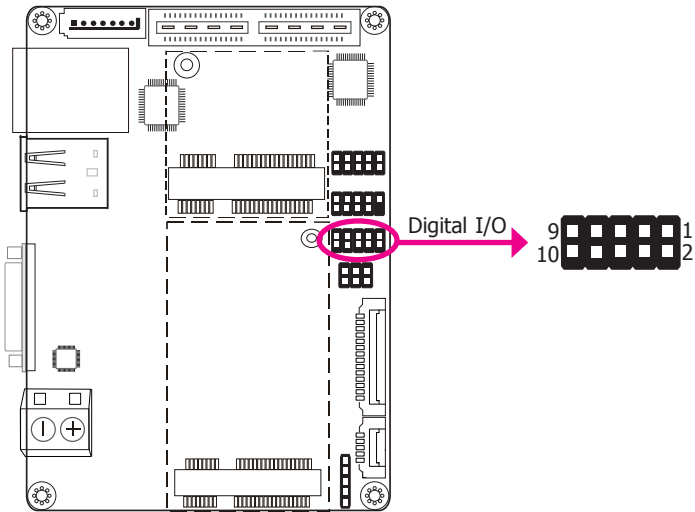

The Digital I/O connector supports 8-bit digital input/output signals to provide the ability of monitoring and controlling the states of the connected external devices.

Digital I/O Connector

Pins	Pin Name
1	DIO7
2	DIO6
3	DIO5
4	DIO4
5	DIO3
6	DIO2
7	DIO1
8	DIO0
9	5V
10	GND

Front Audio Connector

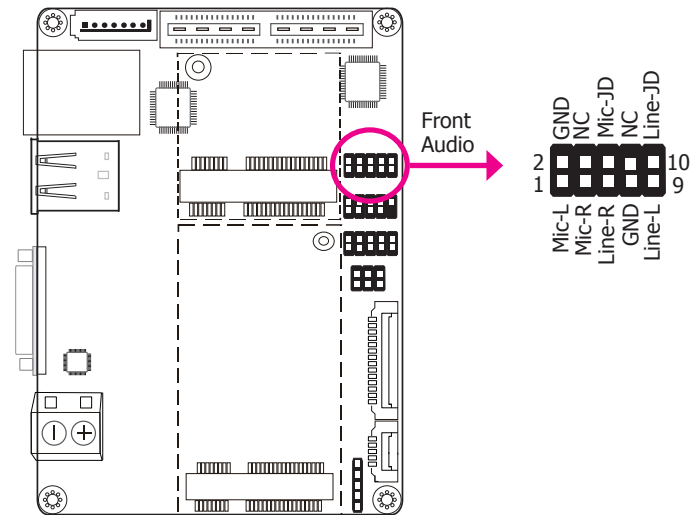

Front Audio

The front audio connector allows you to connect to line-out and mic-in jacks that are at the front panel of your system.

Driver Installation

Install the audio driver. Refer to Chapter 4 for more information.

COM (Serial) Ports

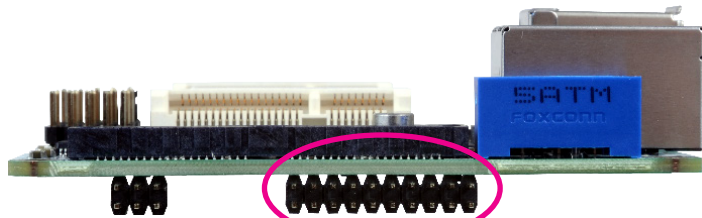

COM 1 COM 2
 COM 1: RS232
 COM 2: RS232/422/485

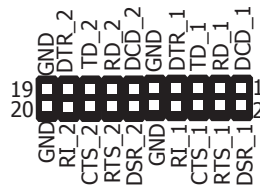

COM 1 is fixed at RS232 whereas COM 2 can be selected among RS232, RS422 and RS485.

The serial ports are asynchronous communication ports with 16C550A-compatible UARTs that can be used with modems, serial printers, remote display terminals, and other serial devices.

BIOS Setting

Configure the serial ports in the "Super IO" submenu of the Advanced menu in the BIOS. Refer to Chapter 3 for more information.

Front Panel Connector

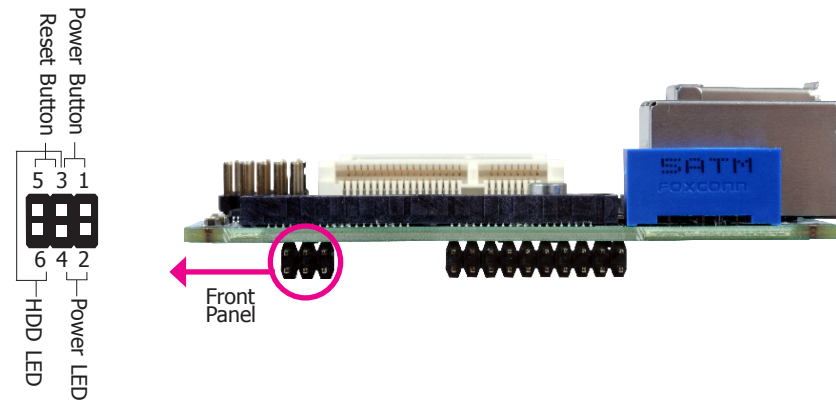

HDD-LED - HDD LED

This LED will light when the hard drive is being accessed.

RESET-SW - Reset Switch

This switch allows you to reboot without having to power off the system.

PWR-BTN - Power Switch

This switch is used to power on or off the system.

PWR-LED - Power/Standby LED

When the system's power is on, this LED will light. When the system is in the S1 (POS - Power On Suspend) state, it will blink every second. When the system is in the S3 (STR - Suspend To RAM) state, it will blink every 4 seconds.

	Pin	Pin Name		Pin	Pin Name
HDD-LED	6	HDD_LED	RESET-SW	5	Reset Button
	3	GND		3	GND
PWR-LED	4	SUS_LED	PWR-BTN	1	Power Button
	2	V_LED		3	GND

SATA (Serial ATA) Connector

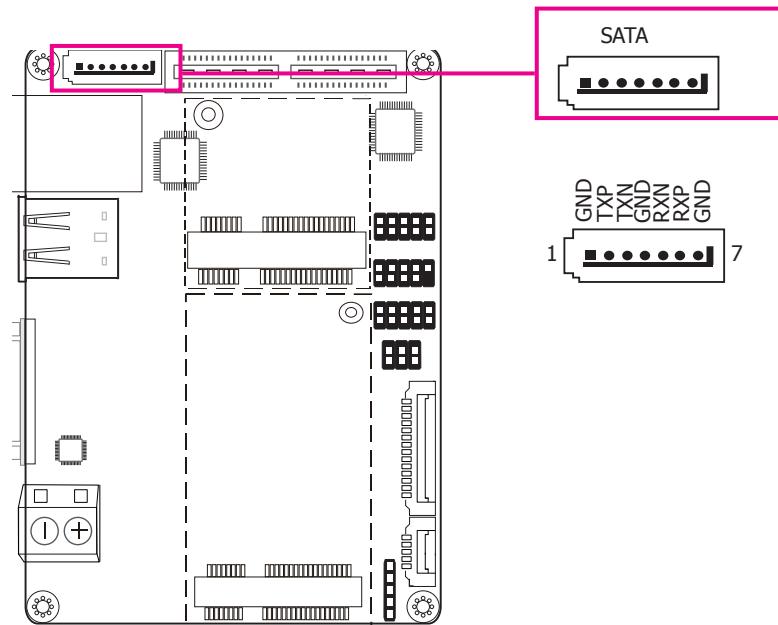

Features

- 1 Serial ATA 3.0 port with data transfer rate up to 6Gb/s
- Integrated Advanced Host Controller Interface (AHCI) controller

The Serial ATA connector is used to connect the Serial ATA device. Connect one end of the Serial ATA data cable to a SATA connector and the other end to your Serial ATA device.

BIOS Setting

Configure the Serial ATA drive in the Advanced menu ("SATA Configuration" submenu) of the BIOS. Refer to Chapter 3 for more information.

Expansion Slot

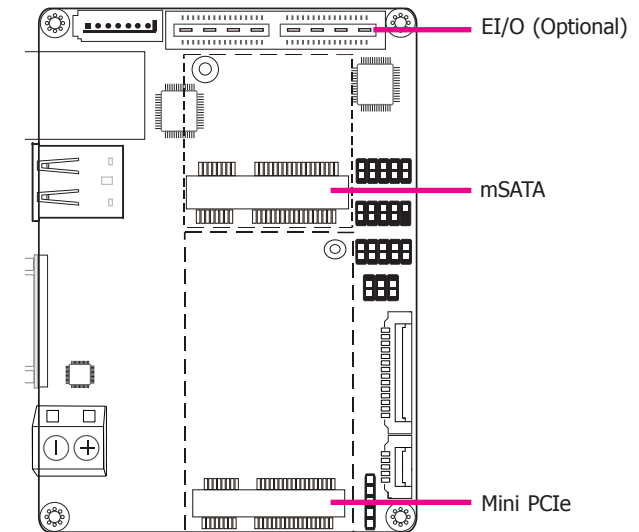

Mini PCI Express Slot

The full-size Mini PCIe socket supports PCIe x1 and USB2.0 signals and is used to install a Mini PCIe card.

mSATA Port

The half-size mSATA port supports SATA III (6Gb/s) transmission rate and is used to connect an mSATA card. It can expand the system's storage capacity.

E I/O Connector (optional)

The EI/O connector supports a multitude of signals such as PCIe, DDI, USB, LPC, and SMBus. It can expand the system's internal I/O connectivity. Please refer to the following table for pin assignment.

E I/O Connector

Pin	Pin Name	Pin	Pin Name
1	PCIE_RX0+	2	PCIE_TX0+
3	PCIE_RX0-	4	PCIE_TX0-
5	GND	6	GND
7	PCIE_RX1+	8	PCIE_TX1+
9	PCIE_RX1-	10	PCIE_TX1-
11	GND	12	GND
13	PCIE_CLK+	14	USB_SSRX1+
15	PCIE_CLK-	16	USB_SSRX1-
17	GND	18	GND
19	USB_SSRX0+	20	USB_SSTX1+
21	USB_SSRX0-	22	USB_SSTX1-
23	GND	24	GND
25	USB_SSTX0+	26	NC
27	USB_SSTX0-	28	NC
29	GND	30	NC
31	SATA0_RX+	32	NC
33	SATA0_RX-	34	GND
35	GND	36	PCIE_WAKE#
37	SATA0_TX+	38	NC
39	SATA0_TX-	40	NC
41	GND	42	SMB_STB_CK
43	DDIO_CTRLCLK_AUX+	44	SMB_STB_DAT
45	DDIO_CTRLCLK_AUX-	46	GND
47	GND	48	CLK33M
49	DDIO_PAIR0+	50	LPC_AD0

51	DDIO_PAIR0-	52	LPC_AD1
53	GND	54	LPC_AD2
55	DDIO_PAIR1+	56	LPC_AD3
57	DDIO_PAIR1-	58	LPC_SERIRQ
59	GND	60	LPC_FRAME#
61	DDIO_PAIR2+	62	DDIO_HPD
63	DDIO_PAIR2-	64	DDIO_AUX_Detect
65	GND	66	GND
67	DDIO_PAIR3+	68	GPIO_STB (INT)
69	DDIO_PAIR3-	70	PLT_RESET#
71	GND	72	12VSB
73	3V3SB	74	12VSB
75	3V3SB	76	PS_ON
77	AUD_GND	78	LINE_JD
79	LINE1_L	80	LINE1_R
81	NPTH	82	NPTH

**Note:**

DFI board's E I/O connector:

Manufacturer: Samtec

Part No: QSE-040-01-L-D-A-K-TR

Description: Board-to-board connector, 80 pin, 0.8mm (pitch), 3.25mm (height), SMT type, 180 degree

LVDS LCD Panel Connector LCD/Inverter Power Connector

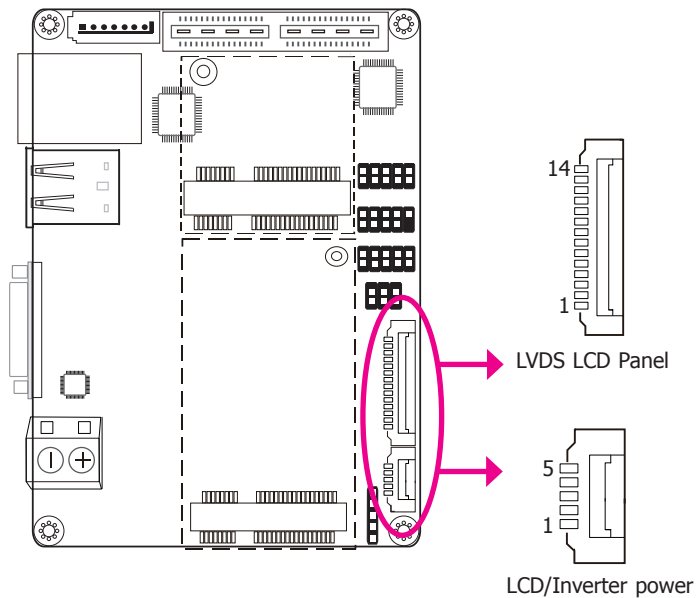

LVDS LCD Panel Connector

Pin	Pin Name	Pin	Pin Name
1	GND	2	GND
3	LVDS_CLK-	4	LVDS_CLK+
5	LVDS_Out3-	6	LVDS_Out3+
7	LVDS_Out2-	8	LVDS_Out2+
9	LVDS_Out1-	10	LVDS_Out1+
11	LVDS_Out0-	12	LVDS_Out0+
13	Panel Power	14	Panel Power

LCD/Inverter Power Connector

Pin	Pin Name
1	+12V
2	GND
3	Panel Backlight On/Off Control
4	Dimming Control
5	+5V

The system board allows you to connect a LCD Display Panel by means of the LVDS LCD panel connector and the LCD/Inverter power connector. These connectors transmit video signals and power from the system board to the LCD Display Panel.

Refer to the right side for the pin functions of these connectors.

BIOS Setting

Configure the LCD panel in the Advanced menu of the BIOS. Refer to Chapter 3 for more information.



Note:

1. DFI board's LVDS connector:

Manufacturer: E-call

Part No: 0110-3221140

Description: Wafer connector, 14 pin, 1.25mm (pitch), 3.45mm (height), SMT type, 90 degree

2. DFI board's LCD/Inverter power connector:

Manufacturer: E-call

Part No: 0110-3221050

Description: Wafer connector, 5 pin, 1.25mm (pitch), 3.45mm (height), SMT type, 90 degree

SMBus Connector

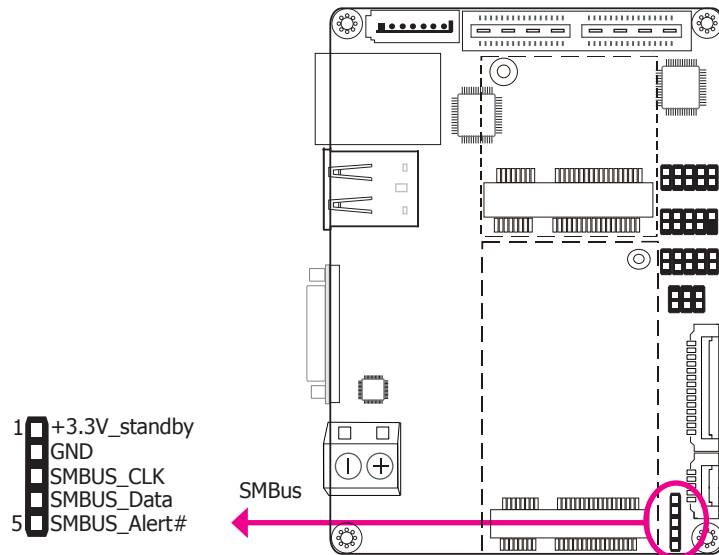

The System Management Bus (SMBus) connector is used to connect SMBus devices. It is a multiple device bus that allows multiple chips to connect to the same bus and enable each one to act as a master by initiating data transfer.

Chapter 3 - BIOS Setup

Overview

The BIOS is a program that takes care of the basic level of communication between the CPU and peripherals. It contains codes for various advanced features found in this system board. The BIOS allows you to configure the system and save the configuration in a battery-backed CMOS so that the data retains even when the power is off. In general, the information stored in the CMOS RAM of the EEPROM will stay unchanged unless a configuration change has been made such as a hard drive replaced or a device added.

It is possible that the CMOS battery will fail causing CMOS data loss. If this happens, you need to install a new CMOS battery and reconfigure the BIOS settings.



Note:

The BIOS is constantly updated to improve the performance of the system board; therefore the BIOS screens in this chapter may not appear the same as the actual one. These screens are for reference purpose only.

Default Configuration

Most of the configuration settings are either predefined according to the Load Optimal Defaults settings which are stored in the BIOS or are automatically detected and configured without requiring any actions. There are a few settings that you may need to change depending on your system configuration.

Entering the BIOS Setup Utility

The BIOS Setup Utility can only be operated from the keyboard and all commands are keyboard commands. The commands are available at the right side of each setup screen.

The BIOS Setup Utility does not require an operating system to run. After you power up the system, the BIOS message appears on the screen and the memory count begins. After the memory test, the message "Press DEL to run setup" will appear on the screen. If the message disappears before you respond, restart the system or press the "Reset" button. You may also restart the system by pressing the <Ctrl> <Alt> and keys simultaneously.

Legends

Keys	Function
Right and Left arrows	Moves the highlight left or right to select a menu.
Up and Down arrows	Moves the highlight up or down between submenu or fields.
<Esc>	Exit to the BIOS Setup Utility.
<F1>	Help
<F5>	Change values
<F6>	Change values
<F9>	Setup Defaults
<F10>	Save and Exit
<Enter>	Press <Enter> to enter the highlighted submenu.

Scroll Bar

When a scroll bar appears to the right of the setup screen, it indicates that there are more available fields not shown on the screen. Use the up and down arrow keys to scroll through all the available fields.

Submenu

When "►" appears on the left of a particular field, it indicates that a submenu which contains additional options are available for that field. To display the submenu, move the highlight to that field and press <Enter>.

Insyde BIOS Setup Utility

Main

The Main menu is the first screen that you will see when you enter the BIOS Setup Utility.

InsydeH20 Setup Utility		Rev. 5.0
Main	Advanced	Security Boot Exit
Project Name	BW051 X64	This is the help for the hour, minute, second field. Valid range is from 0 to 23; 0 to 59, 0 to 59. INCREASE/REDUCE: +/-.
BIOS Version	64.27A	
Processor Type	Intel(R) Atom(TM) x5-E8000 CPU @ 1.04GHz	
CPU Speed	1040MHz	
CPUID	000406C4h	
L1 Data Cache	24 KB	
L1 Instruction Cache	32 KB	
L2 RAN	1024 KB	
L3 Cache	0 KB	
Number of Processors	Core 4	
Microcode Revision	40A	
Total Memory	8192 MB	
System Memory Speed	1600 MHz	
SODIMM 0	8192 MB	
TXE FW Version	2.0.2.2092	
System Time	[21:12:02]	
System Date	[15/4/2016]	

F1 Help ↑/↓ Select Item **F5/F6 Change Values** **F9 Setup Defaults**
Esc Exit ←/→ Select Item **Enter Select ► SubMenu** **F10 Save and Exit**

System Date

The date format is <month>, <date>, <year>. Month displays the month, from January to December. Date displays the date, from 1 to 31. Year displays the year, from 1980 to 2099.

System Time

The time format is <hour>, <minute>, <second>. The time is based on the 24-hour military-time clock. For example, 1 p.m. is 13:00:00. Hour displays hours from 00 to 23. Minute displays minutes from 00 to 59. Second displays seconds from 00 to 59.

Advanced

The Advanced menu allows you to configure your system for basic operation. Some entries are defaults required by the system board, while others, if enabled, will improve the performance of your system or let you set some features according to your preference.



Important:

Setting incorrect field values may cause the system to malfunction.

InsydeH20 Setup Utility		Rev. 5.0
Main	Advanced	Security Boot Exit
► ACPI Configuration		Configures ACPI Tables Features setting
► CPU Configuration		
► Video Configuration		
► Audio Configuration		
► SATA Configuration		
► USB Configuration		
► PCI Express Configuration		
► ME Configuration		
► SIO FINTEK81803		

F1 Help ↑/↓ Select Item **F5/F6 Change Values** **F9 Setup Defaults**
Esc Exit ←/→ Select Item **Enter Select ► SubMenu** **F10 Save and Exit**

ACPI Settings

This section configures the system's ACPI parameters.

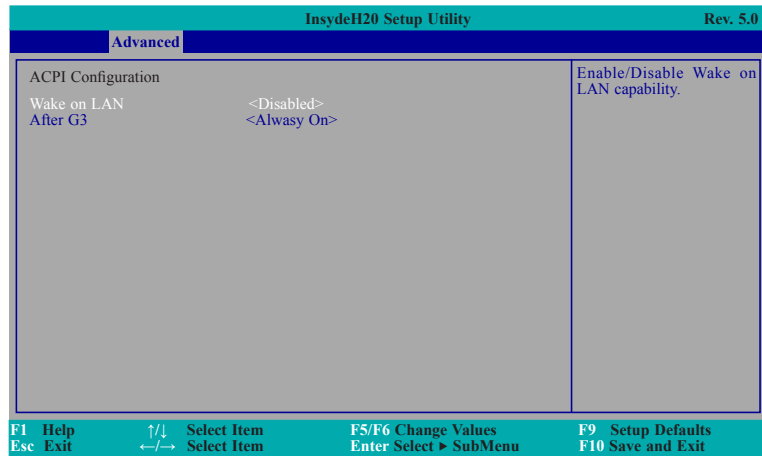

Wake on LAN

Enable or disable WOL (wake-on-LAN) to wake the system through the Ethernet adapter.

State After G3

Specify what state the system should be in when power is re-applied after a power failure (G3, the mechanical-off, state).

Always-on State The system is in working state.

Always-off State The system is in soft-off state.



Note:

For the "After G3" setting to take effect, make sure that the "AC Power Loss" option is set to "Always on" in "SIO FINTEK81803" of the "Advanced" menu.

CPU Configuration

This section configures the CPU.

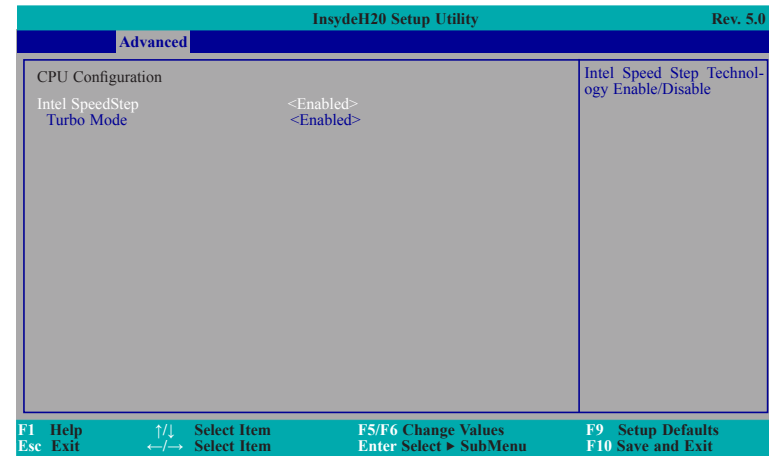

Intel SpeedStep®

This field is used to enable or disable the Enhanced Intel SpeedStep® Technology, which helps optimize the balance between system's power consumption and performance. After it is enabled in the BIOS, you can enable the EIST feature using the operating system's power management.

Turbo Mode

This field is used to enable or disable processor turbo mode (requires that EMTTM is enabled too), which allows the processor core to automatically run faster than the base frequency when the processor's power, temperature, and specification are within the limits of TDP.

Video Configuration

This section configures the video settings.

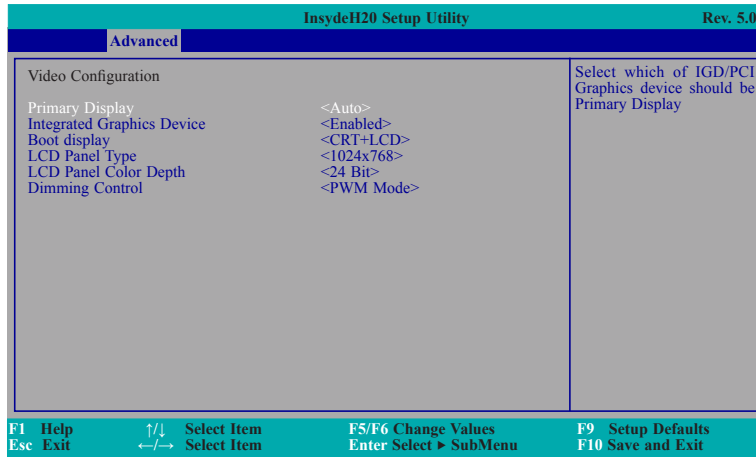

Primary Display

Select either IGD or PCIe Graphics device to be the primary display.

Integrated Graphics Device

Enable or disable the IGD function.

Boot display

Set the display device combination during system booting. The options vary depending on the "Boot Type" selected in the "Boot" menu.

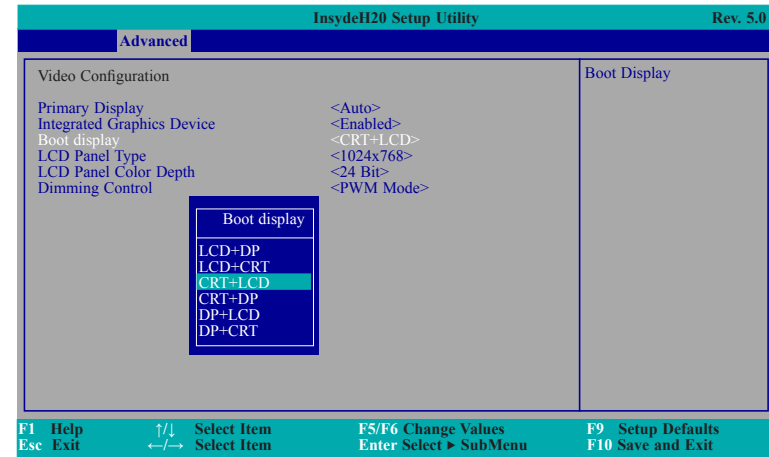

LCD Panel Type

Select the type of LCD panel connected to the system's LCD connector. Please check the specifications of your LCD monitor.

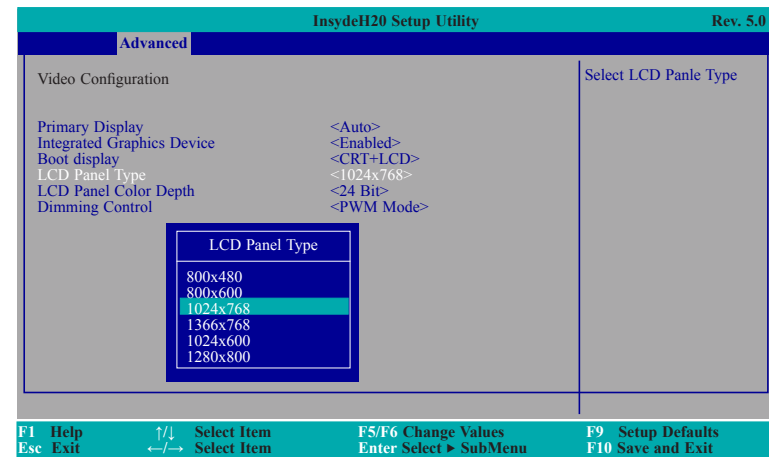

LCD Panel Color Depth

Select the LCD panel color depth.

Dimming Control

Select Dimming control type from PWM or DC mode for the LCD panel.

Audio Configuration

This section configures the audio controller.

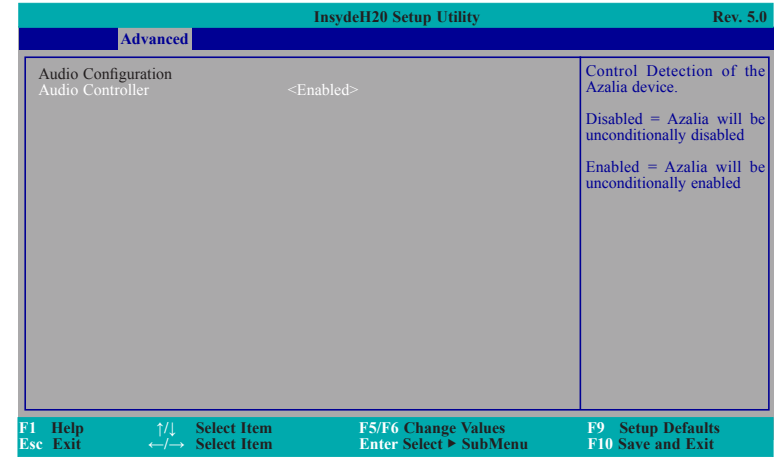
**Audio Controller**

Set to enable or disable the onboard Azalia controller.

Disabled

Azalia will be unconditionally disabled.

Enabled

Azalia will be unconditionally enabled.

SATA Configuration

This section configures the SATA controller.

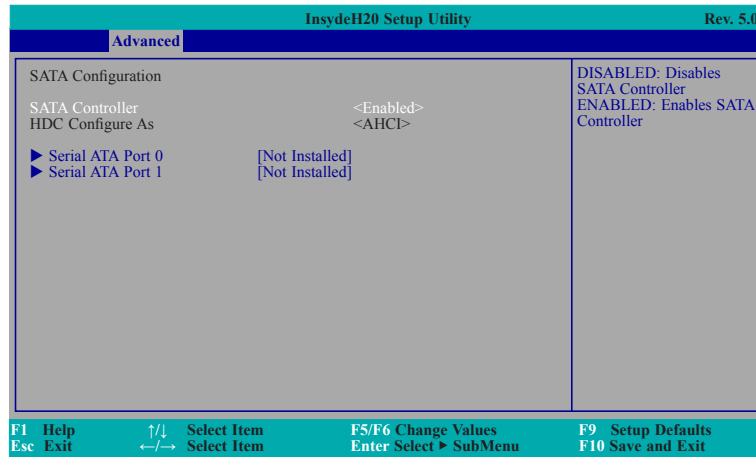

SATA Controller

This field is used to enable or disable the Serial ATA controller.

HDC Configures As

The mode selection determines how the SATA controller(s) operates.

AHCI Mode

This option allows the Serial ATA devices to use AHCI (Advanced Host Controller Interface).

Serial ATA Port 0, and 1

Enable or disable each serial ATA port.

USB Configuration

This configures the parameters of the USB xHCI (eXtensible Host Controller Interface).

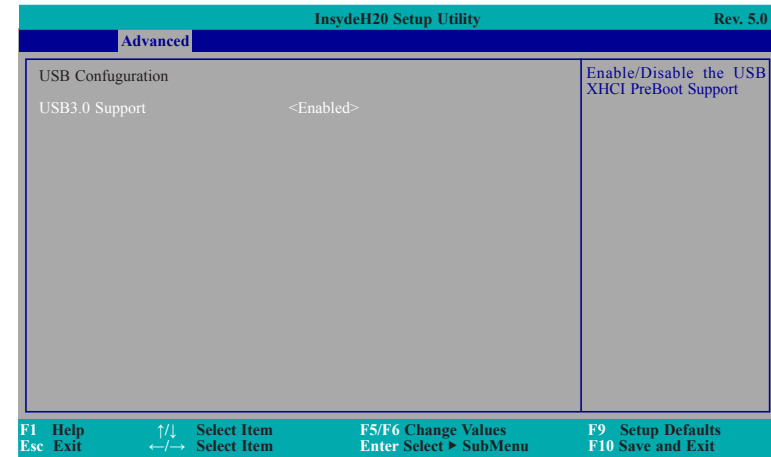

USB3.0 Support

Disabled

Disable USB XHCI Pre-Boot Support.

Enabled

Enable USB XHCI Pre-Boot Support.

PCI Express Configuration

This section configures the settings of PCI Express root ports.

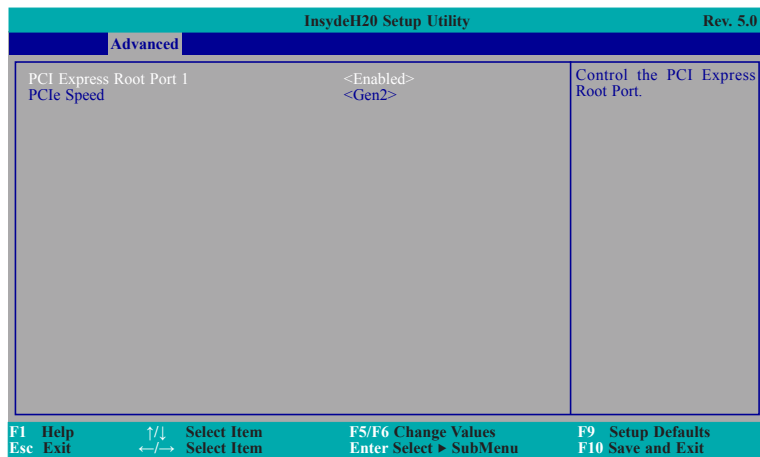
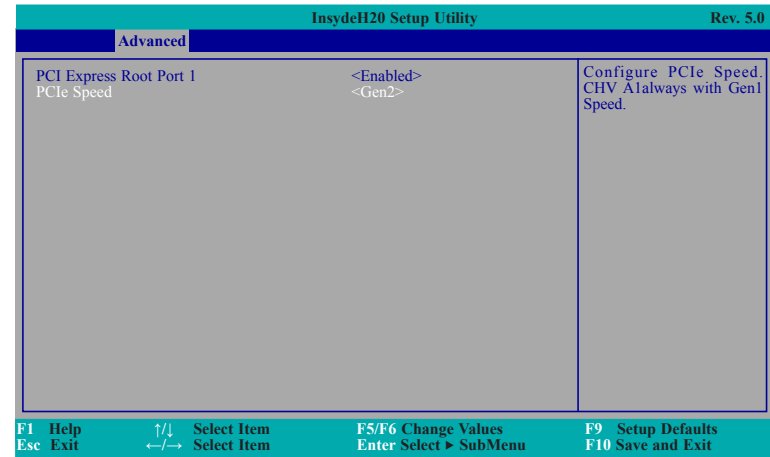
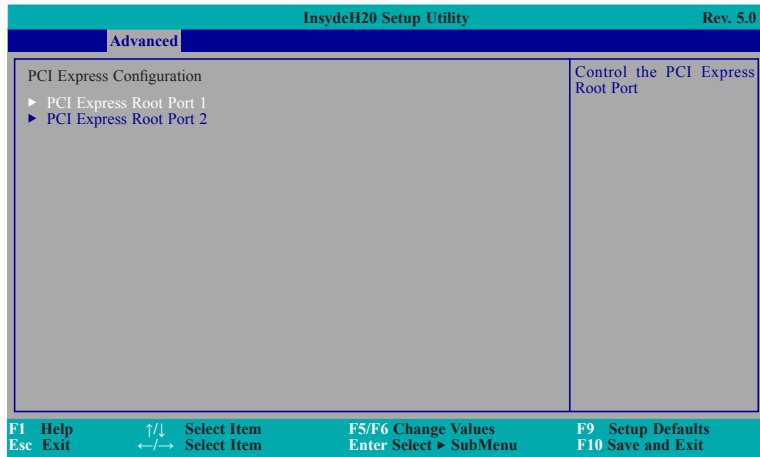

PCI Express Root Port

Enable or disable the PCI Express Root Port.

PCIe Speed

Select the speed of the PCI Express Root Port: Gen1 or Gen2.

ME Configuration

This section configures the settings of Intel® Management Engine.

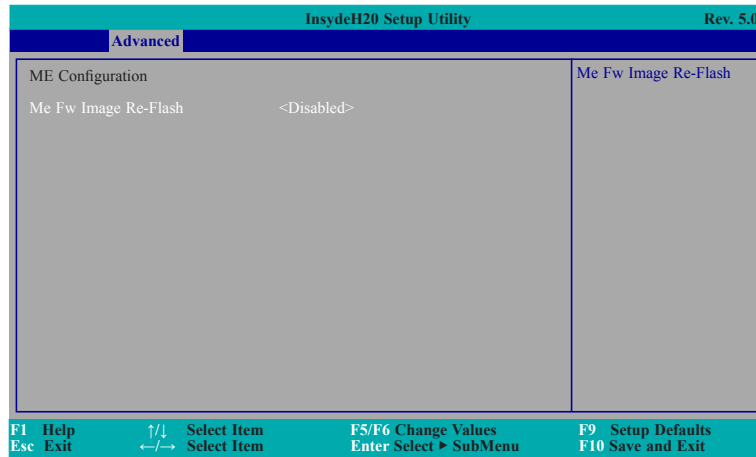

Me Fw Image Re-Flash

Enable or disable flashing of the Intel® Management Engine firmware.

Super IO

This section configures the system super I/O chip parameters.

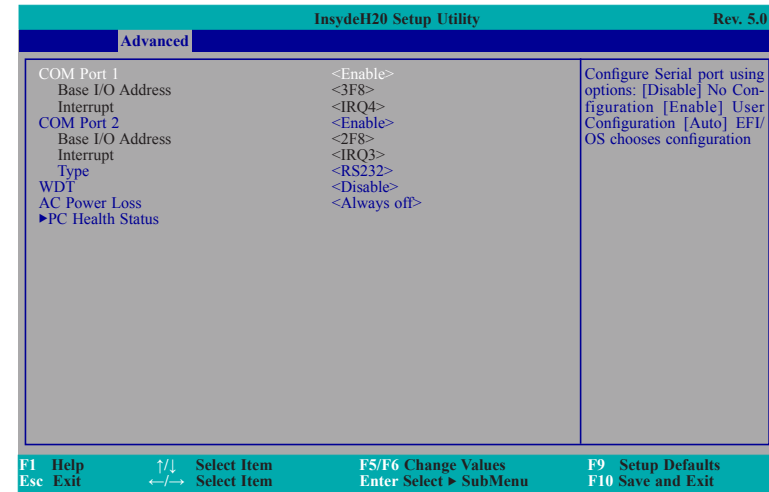

Serial Port 1 to Serial Port 2

Configure the settings of the system's serial ports.

Disable Disable this serial port

Enable Enable this serial port

Type

Choose the serial port type from RS232, RS422 or RS485 for COM port 2 only.

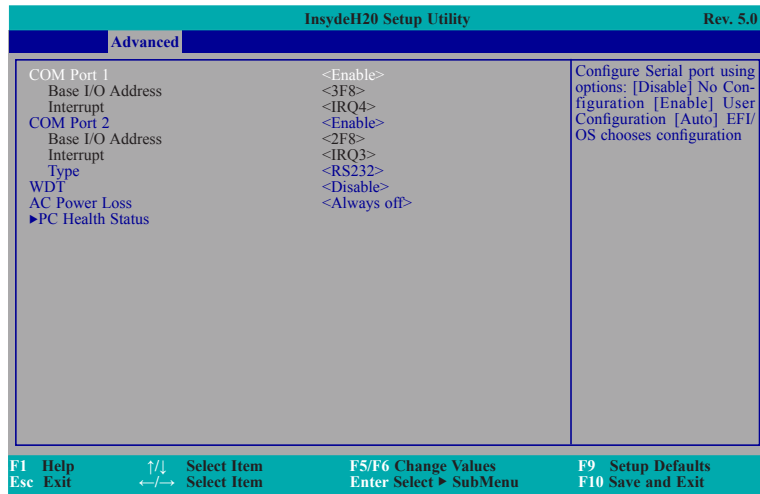

PC Health Status

This section displays the system's health information such as the CPU and system temperatures.

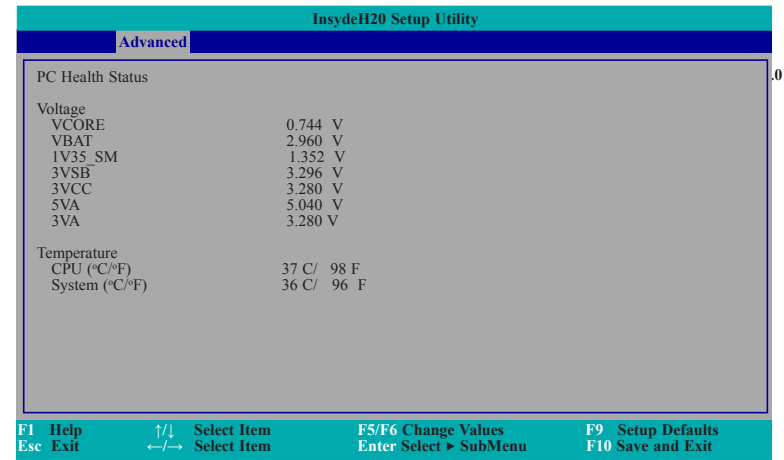

WDT

Enable or disable the watchdog function.

AC Power Loss

Set the AC power loss to Always off or Always on. When set to Always off, the system's status will be power-off after an AC power loss event. When set to Always on, the system's status will be power-on after an AC power loss event.

Security

This section configures the trusted platform module (TPM) function.

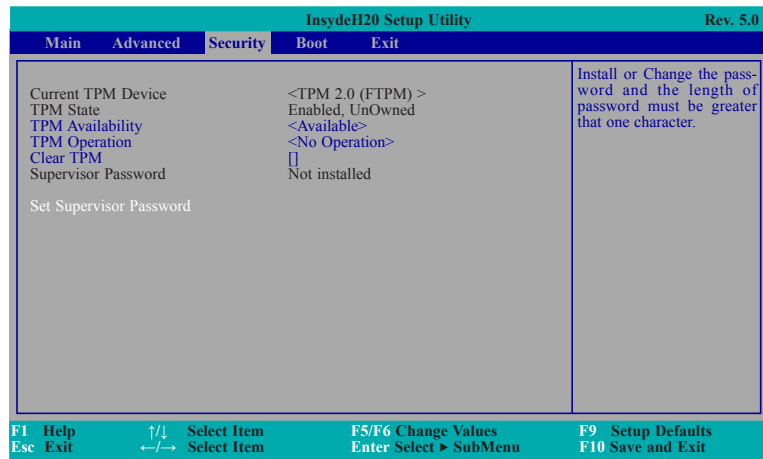

TPM Availability

Show or hide the TPM availability and its configurations.

TPM Operation

Enable or disable the TPM function. It displays the following options:

- No Operation: No changes to current state.
- Disable: Disable and deactivate TPM.
- Enable: Enable and activate TPM.

Clear TPM

Remove all TPM ownership contents.

Set Supervisor Password

Set the administrative password. The length of the password must be greater than one character.

Boot

This section configures boot options.

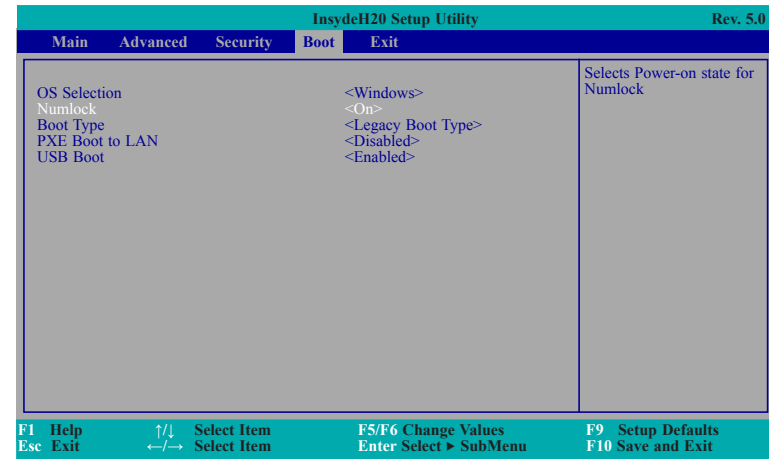

OS Selection

Select the system's operating system from Windows, Linux or DOS.

Numlock

Select the power-on state for numlock.

Boot Type

Select the boot type. The options are Dual Boot Type, Legacy Boot Type or UEFI Boot Type.

PXE Boot Capability

Disable or enable PXE boot to LAN.

USB Boot

Enable or disable the booting to USB boot devices.

Exit

This section configures the parameters for exiting the BIOS menu.

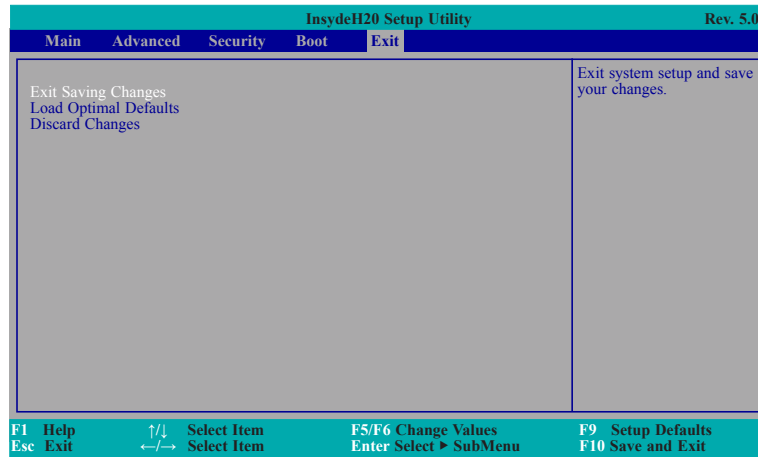

Exit Saving Changes

Select this field and then press <Enter> to exit the system setup and save your changes.

Load Optimal Defaults

Select this field and then press <Enter> to load the factory's defaults.

Discard Changes

Select this field and then press <Enter> to exit the system setup without saving your changes.

Updating the BIOS

To update the BIOS, you will need the new BIOS file and a flash utility. Please contact technical support or your sales representative for the files and specific instructions about how to update BIOS with the flash utility.

When you download the given BIOS file, you may find a BIOS flash utility attached with the BIOS file. This is the utility for performing BIOS updating procedure. For your convenience, we will also provide you with an auto-execution file in the BIOS file downloaded. This auto-execution file will bring you directly to the flash utility menu soon after system boots up and finishes running the boot files in your boot disk.

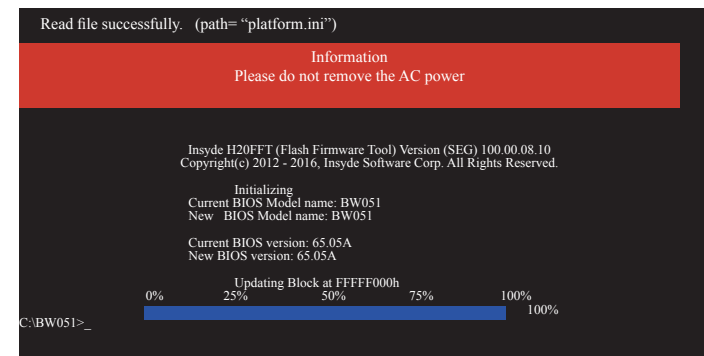

Notice: BIOS SPI ROM

1. The Intel® Management Engine has already been integrated into this system board. Due to the safety concerns, the BIOS (SPI ROM) chip cannot be removed from this system board and used on another system board of the same model.
2. The BIOS (SPI ROM) on this system board must be the original equipment from the factory and cannot be used to replace one which has been utilized on other system boards.
3. If you do not follow the methods above, the Intel® Management Engine will not be updated and will cease to be effective.

**Note:**

- a. You can take advantage of flash tools to update the default configuration of the BIOS (SPI ROM) to the latest version anytime.
- b. When the BIOS IC needs to be replaced, you have to populate it properly onto the system board after the EEPROM programmer has been burned and follow the technical person's instructions to confirm that the MAC address should be burned or not.

Chapter 4 - Supported Software

The DVD that came with the system board contains drivers, utilities and software applications required to enhance the performance of the system board.

Insert the DVD into a DVD-ROM drive. The autorun screen (Mainboard Utility DVD) will appear. If after inserting the DVD, "Autorun" did not automatically start (which is, the Mainboard Utility DVD screen did not appear), please go directly to the root directory of the DVD and double-click "Setup".

For Windows 10

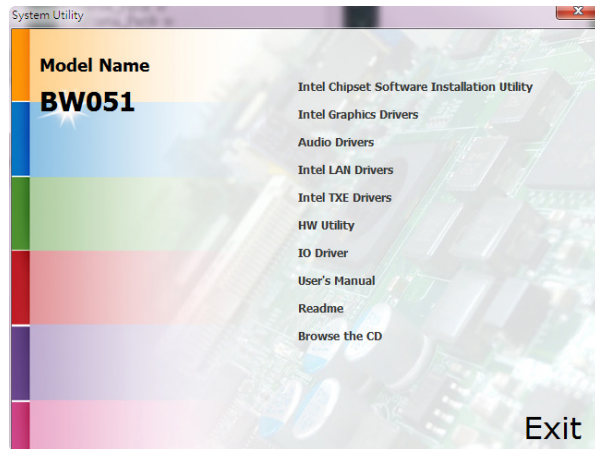

For Windows 8.1

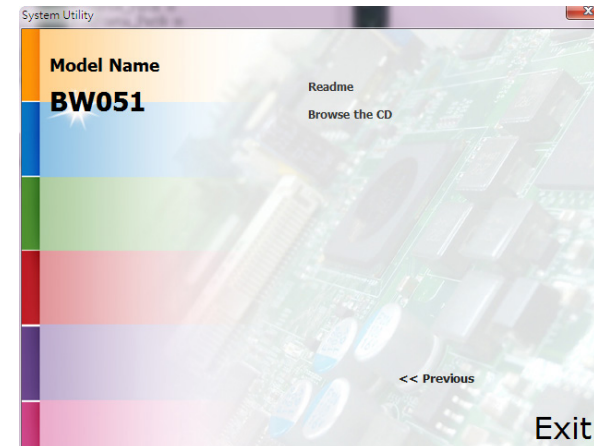

For Windows 7

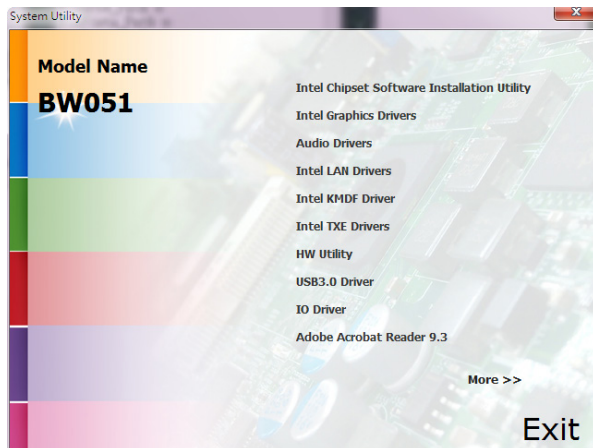

Intel Chipset Software Installation Utility

The Intel Chipset Software Installation Utility is used for updating Windows® INF files so that the Intel chipset can be recognized and configured properly in the system.

To install the utility, click "Intel Chipset Software Installation Utility" on the main menu.

1. Setup is ready to install the utility. Click Next.



2. Read the license agreement then click Yes.



- Go through the readme document for more installation tips then click Next.

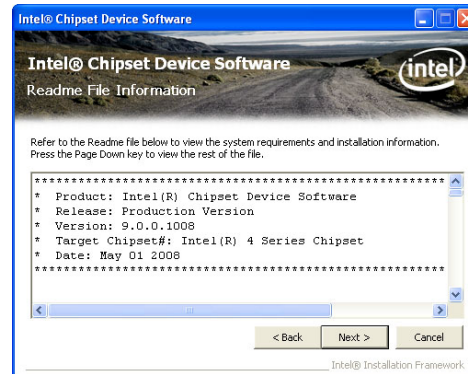

- Click Finish to exit setup.



Intel Graphics Drivers

To install the driver, click "Intel Graphics Drivers" on the main menu.

- Setup is now ready to install the graphics driver. Click Next.



By default, the "Automatically run WinSAT and enable the Windows Aero desktop theme" is enabled. With this enabled, after installing the graphics driver and the system rebooted, the screen will turn blank for 1 to 2 minutes (while WinSAT is running) before the Windows 7/Windows 8.1/Windows 10 desktop appears. The "blank screen" period is the time Windows is testing the graphics performance.

- Read the license agreement then click Yes.

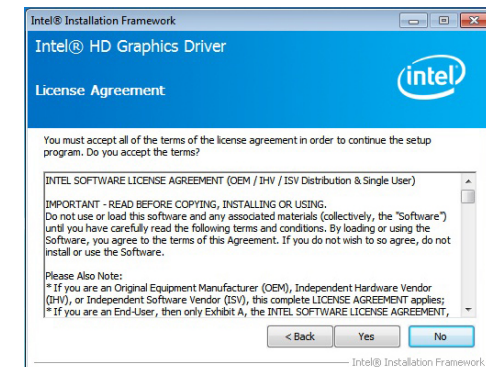

- Go through the readme document for system requirements and installation tips then click Next.

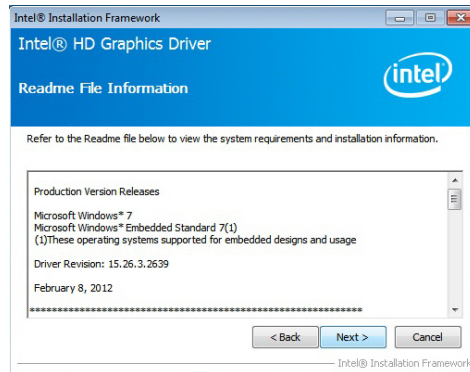

- Setup is now installing the driver. Click Next to continue.

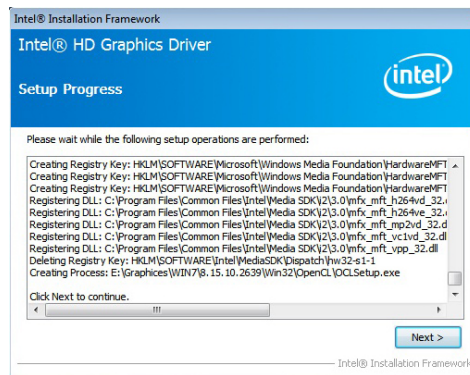

- Click "Yes, I want to restart this computer now" then click Finish.

Restarting the system will allow the new software installation to take effect.

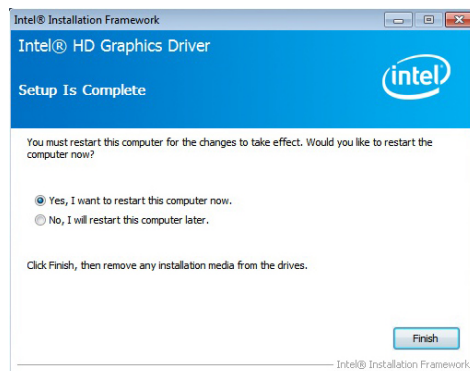

Audio Drivers

To install the driver, click "Audio Drivers" on the main menu.

- Setup is ready to install the driver. Click Next.

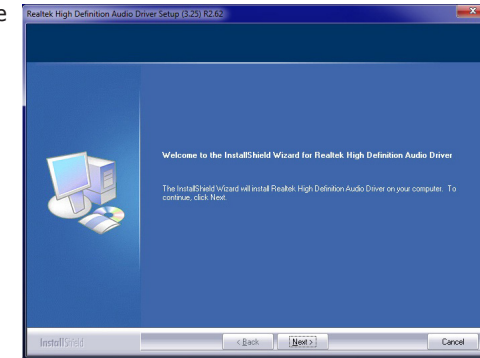

- Click "Yes, I want to restart my computer now" then click Finish.

Restarting the system will allow the new software installation to take effect.

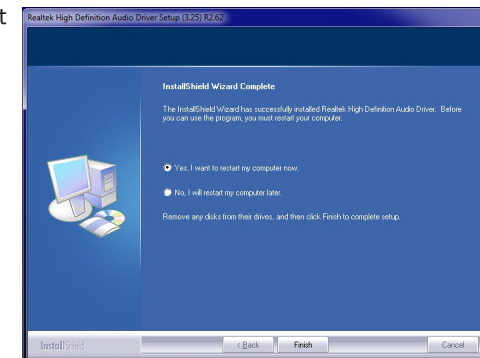

Intel LAN Drivers

To install the driver, click "Intel LAN Drivers" on the main menu.

1. Setup is ready to install the driver. Click Next.



2. Click "I accept the terms in the license agreement" then click "Next".

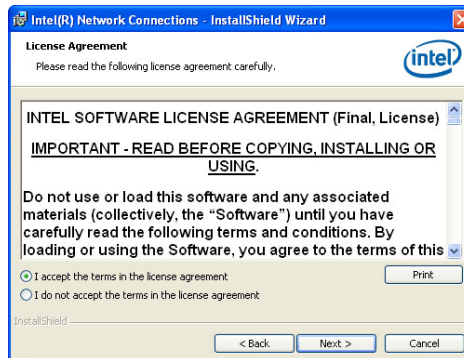

3. Select the program features you want installed then click Next.

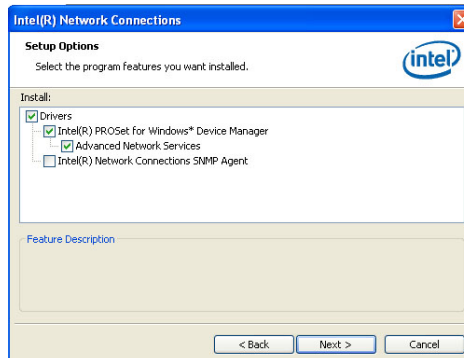

4. Click Install to begin the installation.

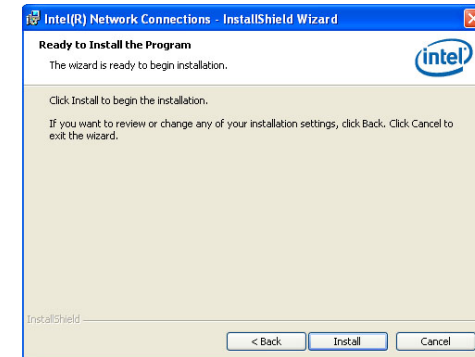

5. After completing installation, click Finish.

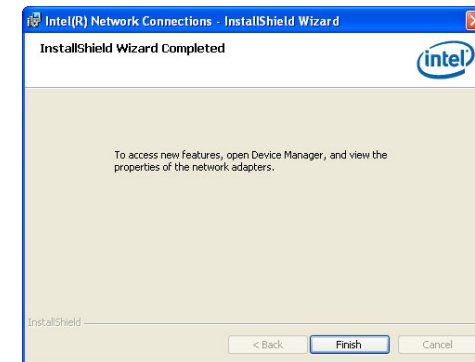

Kernel Mode Driver Framework (For Windows 7 only)

To install the driver, click "Kernel Mode Driver Framework" on the main menu.

1. Click "Yes" to install the update.

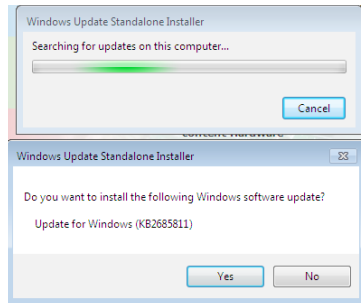

2. The update is installed now.

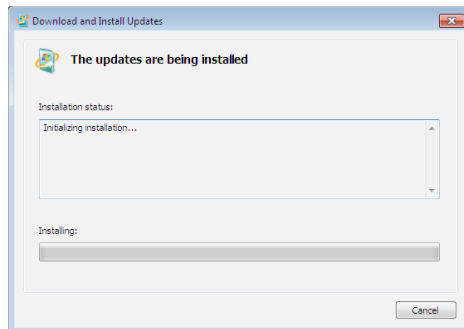

3. Click "Restart Now" to restart your computer when the installation is complete.

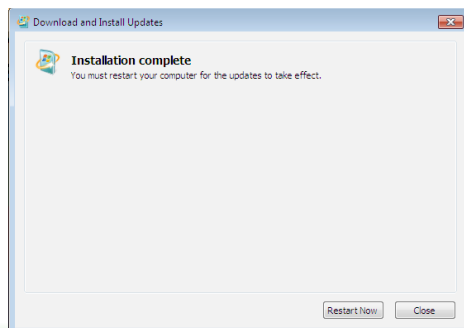

Intel Trusted Execution Engine Driver

To install the driver, click "Intel Trusted Execution Engine Driver" on the main menu.

1. Tick "I accept the terms in the License Agreement" and then click "Next."

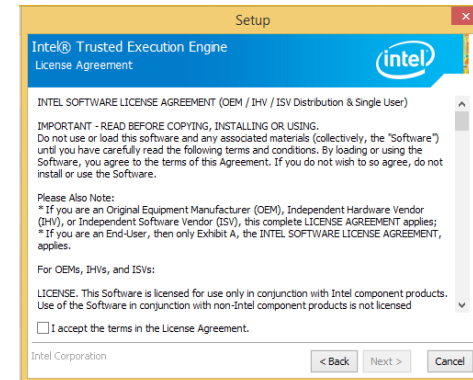

2. The step shows the components which will be installed. Then, Click Next.

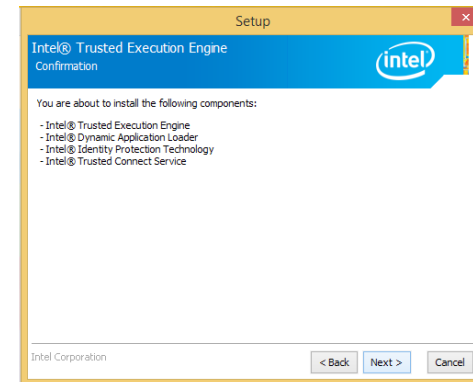

3. The step displays the installing status in the progress.

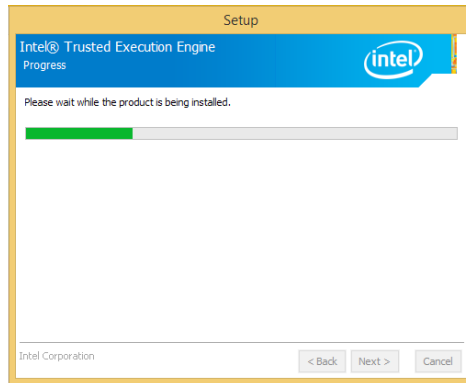

4. Click "Finish" when the installation is complete.

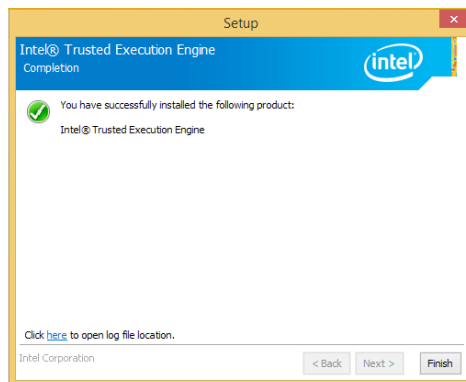

HW Utility

HW Utility provides information about the board, Watchdog, and DIO. To access the utility, click "HW Utility" on the main menu.



Note:

If you are using Windows 7, you need to access the operating system as an administrator to be able to install the utility.

1. Setup is ready to install the driver.

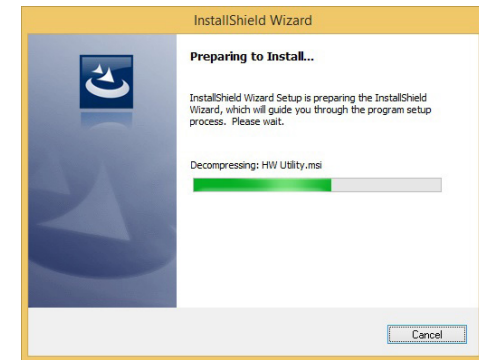

2. Click "Next" to continue.



3. Read the license agreement then click "I accept the terms in the license agreement". Click "Next".

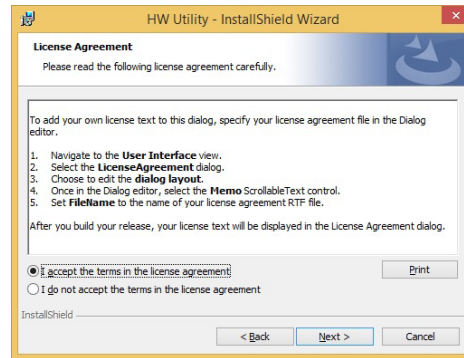

6. After completing installation, click "Finish".

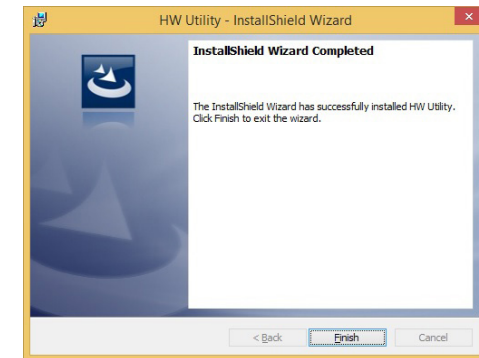

4. The wizard is ready to begin installation. Click "Install".

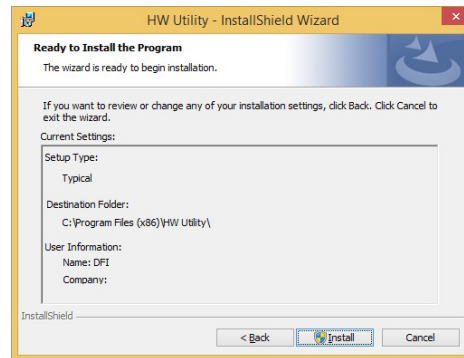

5. Please wait while the program features are being installed.

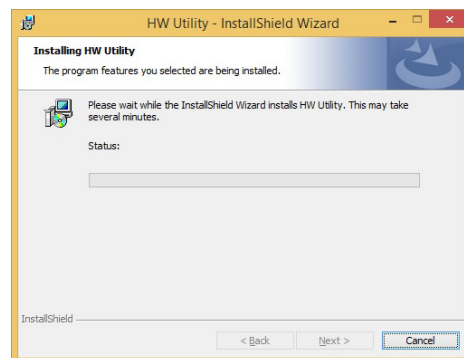

The HW Utility icon will appear on the desktop. Double-click the icon to open the utility.



Information



Note:

Note: The screenshot displayed above is for illustrative purpose only, and may not resemble the actual screen.

The BW051 HW Utility features the following tabs: Information, HW Health, HW Healthset, Watchdog, DIO and Backlight. Click on the tabs to access information about the board.

Intel USB 3.0 Drivers (For Windows 7 and Windows 8.1)

To install the driver, click "Intel USB 3.0 Driver" on the main menu.

1. Setup is ready to install the driver. Click Next.

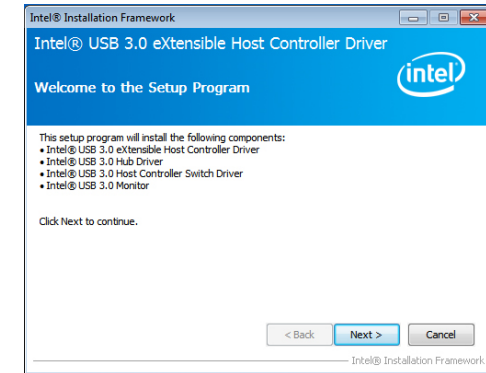

2. Read the license agreement then click Yes.

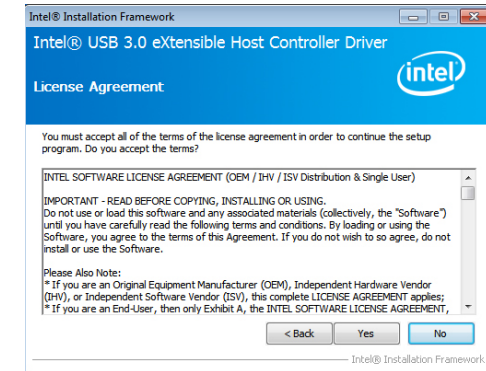

3. Go through the readme document for more installation tips then click Next.

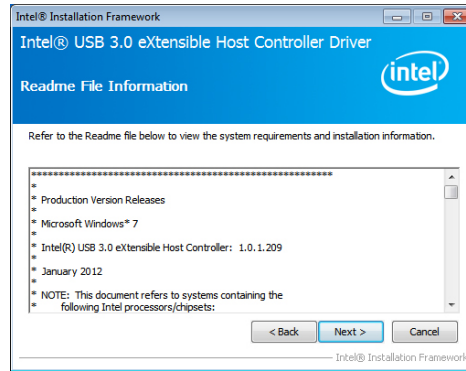

4. Setup is currently installing the driver. After installation has completed, click Next.

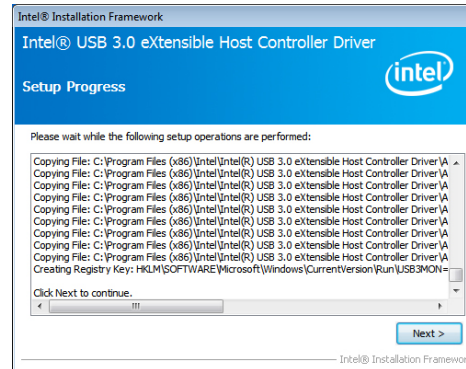

5. After completing installation, click Finish.



IO Driver

To install the driver, click "Intel Serial IO Driver" on the main menu

1. Setup is ready to install the driver. Click Next.

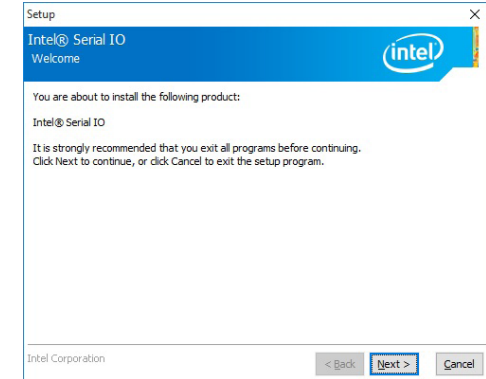

2. Read the license agreement carefully. Click "I accept the terms in the License Agreement" then click Next.

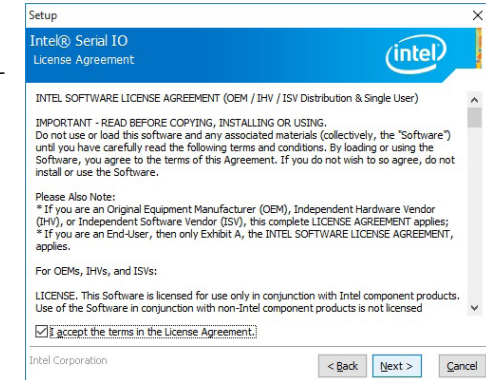

3. Read the file information then click Next.

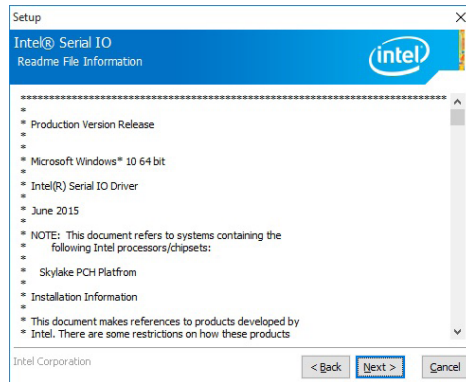

4. Setup is ready to install the driver. Click Next.

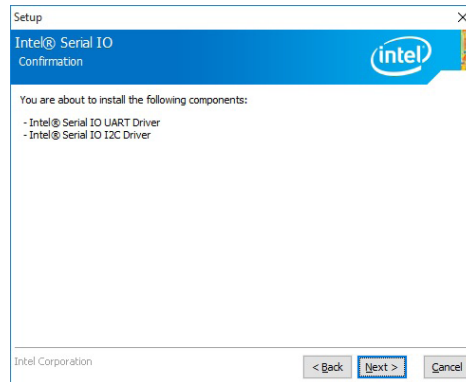

5. Setup is now installing the driver.

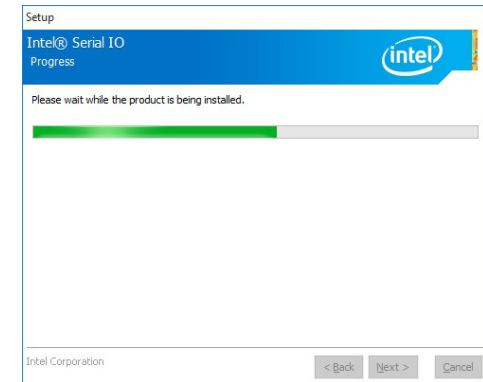

6. Click Finish.

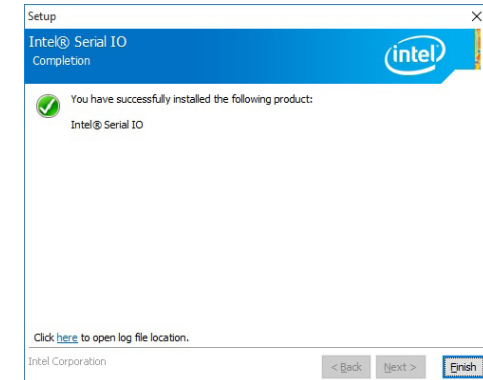

Adobe Acrobat Reader 9.3 (For Windows 7 and Windows 8.1)

To install the reader, click "Adobe Acrobat Reader 9.3" on the main menu.

1. Click Next to install or click Change Destination Folder to select another folder.

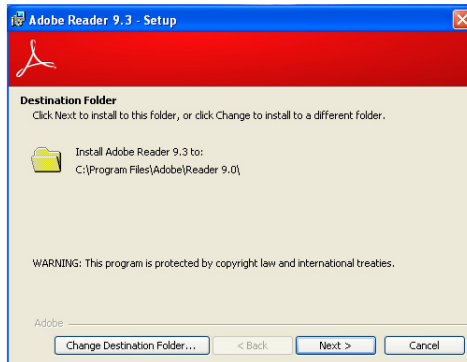

2. Click Install to begin installation.

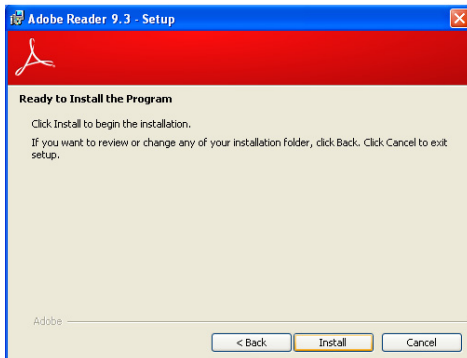

3. Click Finish to exit installation.

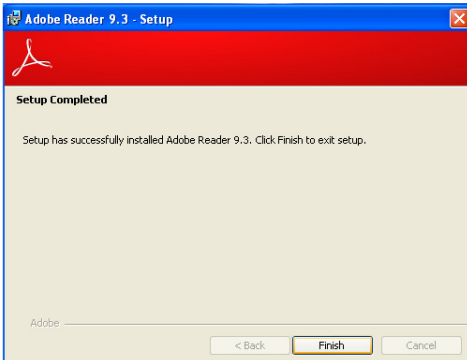

Appendix A - Troubleshooting Checklist

Troubleshooting Checklist

This chapter of the manual is designed to help you with problems that you may encounter with your personal computer. To efficiently troubleshoot your system, treat each problem individually. This is to ensure an accurate diagnosis of the problem in case a problem has multiple causes.

Some of the most common things to check when you encounter problems while using your system are listed below.

1. The power switch of each peripheral device is turned on.
2. All cables and power cords are tightly connected.
3. The electrical outlet to which your peripheral devices are connected is working. Test the outlet by plugging in a lamp or other electrical device.
4. The monitor is turned on.
5. The display's brightness and contrast controls are adjusted properly.
6. All add-in boards in the expansion slots are seated securely.
7. Any add-in board you have installed is designed for your system and is set up correctly.

Monitor/Display

If the display screen remains dark after the system is turned on:

1. Make sure that the monitor's power switch is on.
2. Check that one end of the monitor's power cord is properly attached to the monitor and the other end is plugged into a working AC outlet. If necessary, try another outlet.
3. Check that the video input cable is properly attached to the monitor and the system's display adapter.
4. Adjust the brightness of the display by turning the monitor's brightness control knob.

The picture seems to be constantly moving.

1. The monitor has lost its vertical sync. Adjust the monitor's vertical sync.
2. Move away any objects, such as another monitor or fan, that may be creating a magnetic field around the display.
3. Make sure your video card's output frequencies are supported by this monitor.

The screen seems to be constantly wavering.

1. If the monitor is close to another monitor, the adjacent monitor may need to be turned off. Fluorescent lights adjacent to the monitor may also cause screen wavering.

Power Supply

When the computer is turned on, nothing happens.

1. Check that one end of the AC power cord is plugged into a live outlet and the other end properly plugged into the back of the system.
2. Make sure that the voltage selection switch on the back panel is set for the correct type of voltage you are using.
3. The power cord may have a "short" or "open". Inspect the cord and install a new one if necessary.

Floppy Drive

The computer cannot access the floppy drive.

1. The floppy diskette may not be formatted. Format the diskette and try again.
2. The diskette may be write-protected. Use a diskette that is not write-protected.
3. You may be writing to the wrong drive. Check the path statement to make sure you are writing to the targeted drive.
4. There is not enough space left on the diskette. Use another diskette with adequate storage space.

Hard Drive

Hard disk failure.

1. Make sure the correct drive type for the hard disk drive has been entered in the BIOS.
2. If the system is configured with two hard drives, make sure the bootable (first) hard drive is configured as Master and the second hard drive is configured as Slave. The master hard drive must have an active/bootable partition.

Excessively long formatting period.

If your hard drive takes an excessively long period of time to format, it is likely a cable connection problem. However, if your hard drive has a large capacity, it will take a longer time to format.

Serial Port

The serial device (modem, printer) doesn't output anything or is outputting garbled characters.

1. Make sure that the serial device's power is turned on and that the device is on-line.
2. Verify that the device is plugged into the correct serial port on the rear of the computer.
3. Verify that the attached serial device works by attaching it to a serial port that is working and configured correctly. If the serial device does not work, either the cable or the serial device has a problem. If the serial device works, the problem may be due to the onboard I/O or the address setting.
4. Make sure the COM settings and I/O address are configured correctly.

Keyboard

Nothing happens when a key on the keyboard was pressed.

1. Make sure the keyboard is properly connected.
2. Make sure there are no objects resting on the keyboard and that no keys are pressed during the booting process.

System Board

1. Make sure the add-in card is seated securely in the expansion slot. If the add-in card is loose, power off the system, re-install the card and power up the system.
2. Check the jumper settings to ensure that the jumpers are properly set.
3. Verify that all memory modules are seated securely into the memory sockets.
4. Make sure the memory modules are in the correct locations.
5. If the board fails to function, place the board on a flat surface and seat all socketed components. Gently press each component into the socket.
6. If you made changes to the BIOS settings, re-enter setup and load the BIOS defaults.