

KD331-Q170

Desktop

Q170

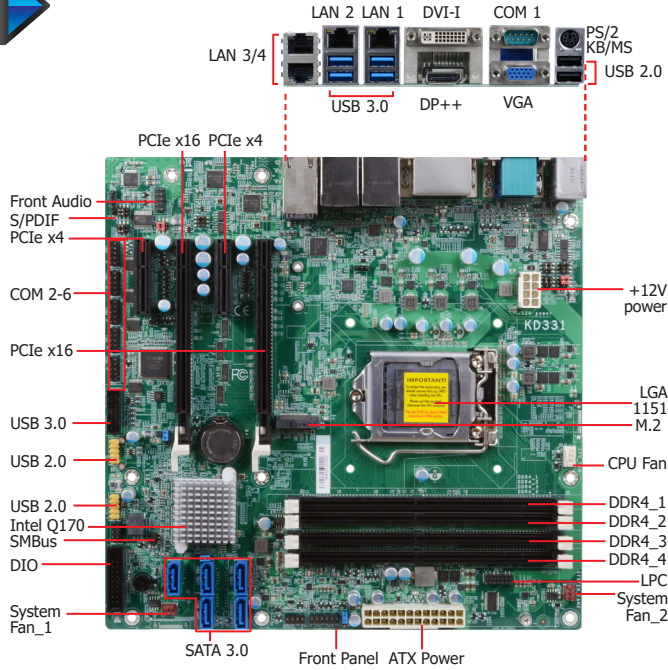

Features

- 4 DDR4 DIMM up to 64GB
- Three independent displays: VGA + DVI-I + DP++
- DP++ resolution up to 4096x2106 @ 60Hz
- Multiple expansion: 2 PCIe x16 (1 x16 or 2 x8 signal), 2 PCIe x4, 1 M.2, 1 LPC
- Rich I/O: 4 Intel GbE, 6 COM, 6 USB 3.0, 6 USB 2.0
- LPC EXT-RS232/485 module extends additional 4 COM ports



Ordering Information

Model Name	P/N	Memory	GbE	RS-232/422/485	RS-232	USB 3.0	USB 2.0	TPM	Power	Thermal	Temp.
KD331-Q170IRM	770-KD3314-000G	4 DIMM	4	2	4	6	6	0	24-pin ATX	Active	0 to 60°C
KD331-Q170IRM	770-KD3314-200G	4 DIMM	4	2	4	6	6	TPM 2.0	24-pin ATX	Active	0 to 60°C

Mechanical Drawing

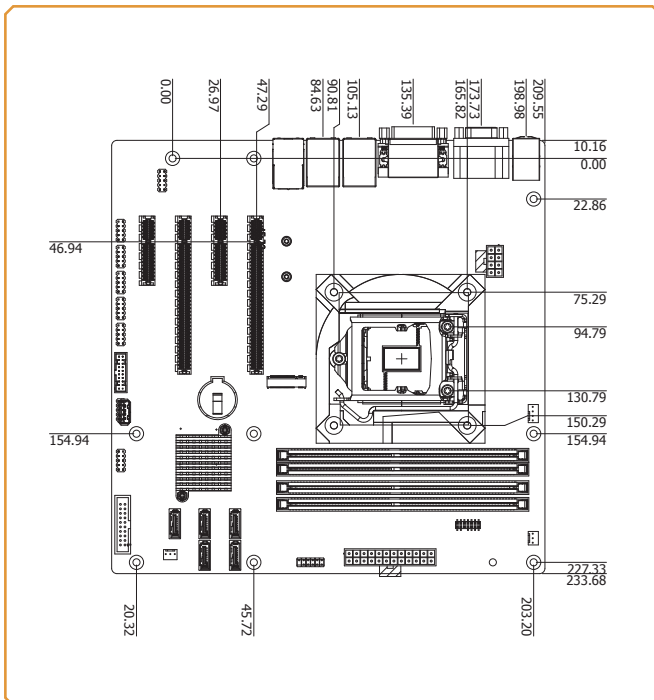

Block Diagram

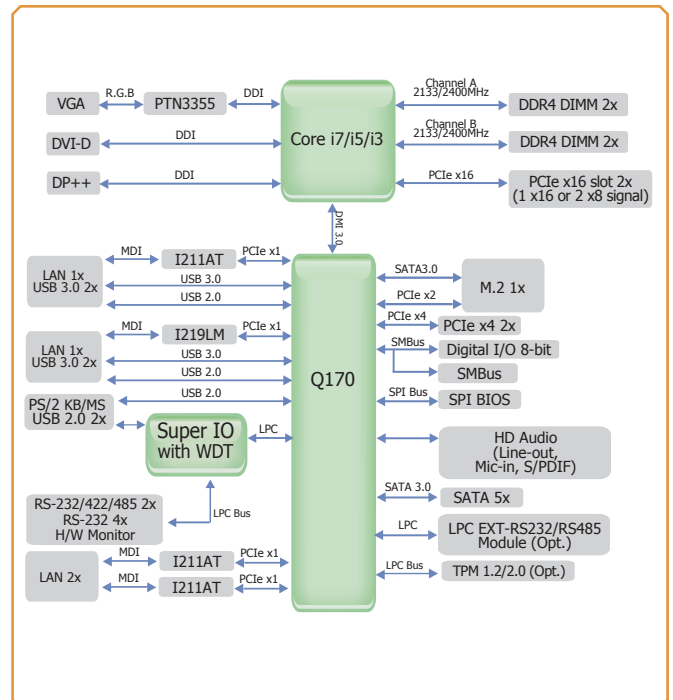

Specifications

SYSTEM	Processor	6th/7th Generation Intel® Core™ /Pentium®/Celeron® LGA 1151 Socket Processors with TDP up to 95W	
	Chipset	Intel® Q170 Chipset	
	Memory	Four 288-pin DIMM up to 64GB	Dual Channel DDR4 2133/2400 MHz
	BIOS	Insyde SPI 128Mbit	
GRAPHICS	Controller	Intel® HD Gen 9 Graphics	
	Feature	OpenGL 5.0, DirectX 12, OpenCL 2.1 HW Decode: AVC/H.264, MPEG2, VC1/WMV9, JPEG/MJPEG, HEVC/H265, VP8, VP9 HW Encode: MPEG2, AVC/H264, JPEG, HEVC/H265, VP8, VP9	
	Display	1 x VGA 1 x DVI-I (DVI-I-D signal) 1 x DP++	VGA: resolution up to 1920x1200 @ 60Hz DVI-I: resolution up to 1920x1200 @ 60Hz DP++: resolution up to 4096x2106 @ 60Hz
	Triple Displays	VGA + DVI-I (DVI-D signal) + DP++	
EXPANSION	Interface	2 x PCIe x16 (1 x16 or 2 x8 signal) (Gen 3) 2 x PCIe x4 (Gen 3) 1 x M.2 2260/2280 M key (SATA3.0/PCIe Gen3 x2 NVMe)	
AUDIO	Audio Codec	Realtek ALC888S-VD2-GR	
ETHERNET	Controller	3 x Intel® I211AT PCIe (10/100/1000Mbps) 1 x Intel® I219LM PCIe (10/100/1000Mbps) (only Core™ i7/i5 supports iAMT)	
REAR I/O	Ethernet	4 x GbE (RJ-45)	
	USB	4 x USB 3.0 2 x USB 2.0	
	Serial	1 x RS-232/422/485 (RS-232 w/ power) (DB-9)	
	PS/2	1 x PS/2 (mini-DIN-6)	
	Display	1 x VGA 1 x DVI-I (DVI-D signal) 1 x DP++	
	INTERNAL I/O	Serial	1 x RS-232/422/485 (RS-232 w/ power) (2.54mm pitch) 4 x RS-232 (2.54mm pitch)
USB		2 x USB 3.0 (2.00mm pitch) 4 x USB 2.0 (2.54mm pitch) or 2 x USB2.0 (2.54mm pitch) +1 x Vertical USB 2.0 (opt., MOQ required)	
Audio		1 x Front Audio Header 1 x S/PDIF	
SATA		5 x SATA 3.0 (up to 6Gb/s)	RAID 0/1/5/10
DIO		1 x 8-bit DIO	
LPC		1 x LPC (supports LPC EXT-RS232/RS485 module)	
SMBus		1 x SMBus	
WATCHDOG TIMER		Output & Interval	System Reset, Programmable via Software from 1 to 255 Seconds
SECURITY	TPM	Infineon TPM2.0/1.2 (opt., MOQ required)	
POWER	Type	ATX	
	Connector	8-pin ATX 12V power	24-pin ATX power
	Consumption	Typical: i7-7700: 3.3V @ 0.4817A (1.58961W); 5V @ 0.5781A (2.8905W); 12V @ 0.3707A (4.4484W) Max.: i7-7700: 3.3V @ 0.476A (1.5708W); 5V @ 0.6863A (3.4315W); 12V @ 9.2347A (110.816W)	
	RTC Battery	CR2032 Coin Cell	
OS SUPPORT		Windows 7 32/64-bit Windows 8.1 64-bit Windows 10 64-bit Linux Note: 7th Gen CPU SKU ONLY support Windows 10 64-bit & Linux.	
ENVIRONMENT	Temperature	Operating: 0 to 60°C	Storage: -30 to 60°C with RTC Battery -40 to 85°C without RTC Battery
	Humidity	Operating: 5 to 90% RH	Storage: 5 to 90% RH
	MTBF	503,212hrs @ 25°C; 281,329hrs @ 45°C ; 175,239hrs @ 60°C Calculation Model: Telcordia Issue 4 Environment: GB, GC - Ground Benign, Controlled	
MECHANICAL	Dimensions	microATX form factor	244mm (9.6") x 244mm (9.6")
	Height	PCB: TBD	Top Side: TBD, Bottom Side: TBD
CERTIFICATIONS		CE, FCC, RoHS, UL	

Packing List

• 1 KD331-Q170 motherboard	
• 1 COM port cables (Length: 300mm, 2 x COM ports)	A81-015026-023G
• 1 Serial ATA data cable (Length: 500mm)	332-553001-005G
• 1 I/O shield	A49-KD3310-000G
• 1 M.2 standoff	A33-725019-090G
• 1 M.2 screw	A32-112016-041G

Optional Items

• USB 2.0 port cable (Length: 350mm)	A81-001066-016G
• USB 3.0 port cable (Length: 320mm)	A81-001052-023G
• D-SUB cable (w/Bracket, Length: 300mm, 2 x DB9)	A81-015026-023G
• Serial ATA data cable (w/Lock, Length: 500mm)	332-553001-005G
• Thermal solution (For 35W, Height: 37.3mm)	A71-103004-000G
• Thermal solution (For 65W, Height: 74.47mm)	A71-101158-000G
• Thermal solution (For 95W, Height: 77.2mm)	761-103001-000G
• LPC EXT-RS232 module (4 x RS232 ports)	770-EXTRS1-000G
• DP to HDMI Dongle	612-D2H13M-000G