

DFI

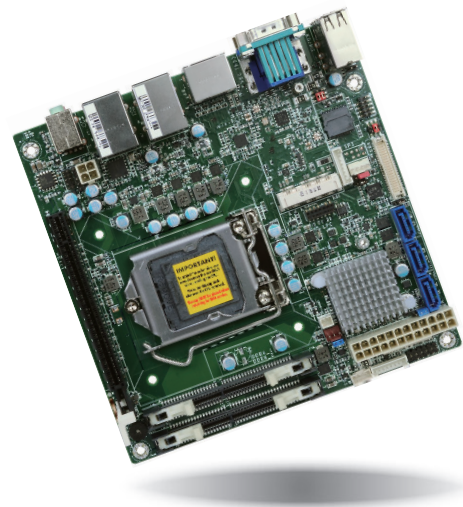

CS100-Q370/C246/H310
Mini-ITX Industrial Motherboard
User's Manual

Copyright

This publication contains information that is protected by copyright. No part of it may be reproduced in any form or by any means or used to make any transformation/adaptation without the prior written permission from the copyright holders.

This publication is provided for informational purposes only. The manufacturer makes no representations or warranties with respect to the contents or use of this manual and specifically disclaims any express or implied warranties of merchantability or fitness for any particular purpose. The user will assume the entire risk of the use or the results of the use of this document. Further, the manufacturer reserves the right to revise this publication and make changes to its contents at any time, without obligation to notify any person or entity of such revisions or changes.

Changes after the publication's first release will be based on the product's revision. The website will always provide the most updated information.

© 2019. All Rights Reserved.

Trademarks

Product names or trademarks appearing in this manual are for identification purpose only and are the properties of the respective owners.

FCC and DOC Statement on Class B

This equipment has been tested and found to comply with the limits for a Class B digital device, pursuant to Part 15 of the FCC rules. These limits are designed to provide reasonable protection against harmful interference when the equipment is operated in a residential installation. This equipment generates, uses and can radiate radio frequency energy and, if not installed and used in accordance with the instruction manual, may cause harmful interference to radio communications. However, there is no guarantee that interference will not occur in a particular installation. If this equipment does cause harmful interference to radio or television reception, which can be determined by turning the equipment off and on, the user is encouraged to try to correct the interference by one or more of the following measures:

- Reorient or relocate the receiving antenna.
- Increase the separation between the equipment and the receiver.
- Connect the equipment into an outlet on a circuit different from that to which the receiver is connected.
- Consult the dealer or an experienced radio TV technician for help.

Notice:

1. The changes or modifications not expressly approved by the party responsible for compliance could void the user's authority to operate the equipment.
2. Shielded interface cables must be used in order to comply with the emission limits.

Table of Contents

Copyright.....	2
Trademarks	2
FCC and DOC Statement on Class B.....	2
Warranty.....	4
Static Electricity Precautions.....	4
Safety Measures.....	4
About the Package.....	5
Optional Items.....	5
Before Using the System Board.....	5
Chapter 1 - Introduction.....	6
Specifications	6
Features.....	7
Chapter 2 - Hardware Installation.....	9
Board Layout.....	9
Block Diagram.....	9
System Memory.....	9
Installing the SODIMM Module	11
CPU.....	12
Installing the CPU.....	13
Installing the Fan and Heat Sink.....	15
Jumper Settings	16
Clear CMOS.....	16
Backlight Brightness Select.....	16
COM 2 RS232/Power Select.....	17
LCD/Inverter Power Select	18
Panel Power Select	18
Mini PCIe/mSATA Signal Select (CS100-Q370/C246 only).....	19
Rear Panel I/O Ports.....	20
RJ45 LAN Ports.....	20
USB Ports.....	21
Graphics Interfaces.....	21
COM (Serial) Ports.....	22
Audio	22

I/O Connectors.....	23
SATA (Serial ATA) Connectors.....	23
Digital I/O Connector.....	23
Digital I/O Power Connector.....	23
Cooling Fan Connectors.....	24
Power Connectors.....	24
LVDS LCD Panel Connector	25
LCD/Inverter Power Connector	25
Chassis Intrusion Connector	26
Front Panel Connector	26
Expansion Slots	27
S/PDIF Connector	27
LPC Connector.....	28
Connecting the EXT-RS232/RS485 Card to the Motherboard	28
Battery.....	29

Chapter 3 - BIOS Setup..... 30

Overview.....	30
AMI BIOS Setup Utility.....	31
Main	31
Advanced	32
Chipset	43
Security.....	47
Boot.....	47
Save & Exit	48
Updating the BIOS.....	49
Notice: BIOS SPI ROM	49

Chapter 4 - Supported Software..... 50

Chapter 5 - RAID (CS100-Q370/C246 Only)..... 58

Chapter 6 - Intel AMT Settings (CS100-Q370/C246 Only)..... 60

Warranty

1. Warranty does not cover damages or failures that arised from misuse of the product, inability to use the product, unauthorized replacement or alteration of components and product specifications.
2. The warranty is void if the product has been subjected to physical abuse, improper installation, modification, accidents or unauthorized repair of the product.
3. Unless otherwise instructed in this user's manual, the user may not, under any circumstances, attempt to perform service, adjustments or repairs on the product, whether in or out of warranty. It must be returned to the purchase point, factory or authorized service agency for all such work.
4. We will not be liable for any indirect, special, incidental or consequential damages to the product that has been modified or altered.

Static Electricity Precautions

It is quite easy to inadvertently damage your PC, system board, components or devices even before installing them in your system unit. Static electrical discharge can damage computer components without causing any signs of physical damage. You must take extra care in handling them to ensure against electrostatic build-up.

1. To prevent electrostatic build-up, leave the system board in its anti-static bag until you are ready to install it.
2. Wear an antistatic wrist strap.
3. Do all preparation work on a static-free surface.
4. Hold the device only by its edges. Be careful not to touch any of the components, contacts or connections.
5. Avoid touching the pins or contacts on all modules and connectors. Hold modules or connectors by their ends.



Important:

Electrostatic discharge (ESD) can damage your processor, disk drive and other components. Perform the upgrade instruction procedures described at an ESD workstation only. If such a station is not available, you can provide some ESD protection by wearing an antistatic wrist strap and attaching it to a metal part of the system chassis. If a wrist strap is unavailable, establish and maintain contact with the system chassis throughout any procedures requiring ESD protection.

Safety Measures

To avoid damage to the system:

- Use the correct AC input voltage range.

To reduce the risk of electric shock:

- Unplug the power cord before removing the system chassis cover for installation or servicing. After installation or servicing, cover the system chassis before plugging the power cord.

About the Package

The package contains the following items. If any of these items are missing or damaged, please contact your dealer or sales representative for assistance.

- One CS100-Q370/C246/H310 motherboard
- One COM port cable (Length: 250mm, 1 x COM port)
- One I/O shield
- One Serial ATA data cable (Length: 500mm)

The board and accessories in the package may not come similar to the information listed above. This may differ in accordance to the sales region or models in which it was sold. For more information about the standard package in your region, please contact your dealer or sales representative.

Optional Items

- USB port cable (Length: 200mm)
- COM port cable (Length: 250mm, 1 x COM port)
- Serial ATA data cable (Length: 500mm)
- Thermal solution (For 35W, Height: 37.3mm)
- Thermal solution (For 65W, Height: 72.8mm)
- Thermal solution (For 80W, Height: 77.1mm)
- LPC EXT-RS232 module (4 x RS232 ports)
- LPC EXT-RS485 module (4 x RS485 ports)

The board and accessories in the package may not come similar to the information listed above. This may differ in accordance to the sales region or models in which it was sold. For more information about the standard package in your region, please contact your dealer or sales representative.

Before Using the System Board

Before using the system board, prepare basic system components.

If you are installing the system board in a new system, you will need at least the following internal components.

- A CPU
- Memory module
- Storage devices such as hard disk drive, etc.

You will also need external system peripherals you intend to use which will normally include at least a keyboard, a mouse and a video display monitor.

Chapter 1 - Introduction

Specifications

SYSTEM	Processor	8th Generation Intel® Core™ Processors, LGA 1151 Socket, TDP up to 80W Intel® Xeon E-2176G Processor (support ECC Memory) Intel® Core™ i7-8700 Processor Intel® Core™ i5-8500 Processor Intel® Core™ i3-8100 Processor (support ECC Memory) Intel® Pentium G5400 Processor (support ECC Memory) Intel® Celeron G4900 Processor (support ECC Memory)
	Memory	Two 260-pin SODIMM up to 32GB Dual Channel DDR4 2400/2666MHz (C246 support ECC)
	Chipset	Intel® Q370/C246/H310 Chipset
	BIOS	AMI SPI 128Mbit
GRAPHICS	Controller	Intel® UHD Graphics 630 (Pentium G5400, Celeron G4900 support Intel® UHD Graphics 610)
	Feature	OpenGL 4.4, DirectX 12, OpenCL 2.1 HW Decode: AVC/H.264, MPEG2, VC1/WMV9, JPEG/MJPEG, HEVC/H265, VP8, VP9 HW Encode: AVC/H.264, MPEG2, JPEG, HEVC/H265, VP8, VP9
	Display	1 x LVDS 1 x VGA 2 x DP++ LVDS: resolution up to 1920x1200 @ 60Hz VGA: resolution up to 1920x1200 @ 60Hz DP++: resolution up to 4096x2304 @ 60Hz
	Triple Displays	LVDS + VGA + DP++, LVDS + DP++ + DP++, VGA + DP++ + DP++
EXPANSION	Interface	Q370/C246: 1 x PCIe x16 (Gen 3) 1 x Full-size Mini PCIe (& mSATA) H310: 1 x PCIe x16 (Gen 3) 1 x mSATA
AUDIO	Audio Codec	Realtek ALC888S-VD2-GR
ETHERNET	Controller	C246/Q370: 1 x Intel® I219LM PHY, 1 x Intel® i210AT PCIe (10/100/1000Mbps) (only Core i7/i5 support iAMT) H310: 1 x Intel® I219V PHY, 1 x Intel® i210AT PCIe (10/100/1000Mbps)
REAR I/O	Ethernet	2 x GbE (RJ-45)
	USB	Q370/C246: 2 x USB 3.1 Gen2 2 x USB 3.1 Gen1 4 x USB 2.0 H310: 4 x USB 3.1 Gen1 4 x USB 2.0
	Display	1 x VGA 2 x DP++
	Serial	1 x RS-232 (DB-9)
	Audio	1 x Line-in (available upon request) 1 x Line-out 1 x Mic-in

INTERNAL I/O	Serial	1 x RS-232 (RS-232 w/ power) (2.0mm pitch)
	Display	1 x LVDS LCD Panel Connector 1 x LCD/Inverter Power
	Audio	1 x S/PDIF 1 x Front Audio
	SATA	3 x SATA 3.0 (up to 6Gb/s)
	DIO	1 x 8-bit DIO
	LPC	1 x LPC (support LPC EXT-RS232/RS485 module)
WATCHDOG TIMER	Output & Interval	System Reset, Programmable via Software from 1 to 255 Seconds
SECURITY	TPM	dTPM 2.0 (available upon request)
POWER	Type	ATX
	Connector	4-pin ATX 12V power 24-pin ATX power
	RTC Battery	CR2032 Coin Cell
	Consumption	Idle: i7-8700 65W: 12V @ 0.39A (4.68W), 5V @ 0.53A (2.65W), 3.3V @ 0.23A (0.795W) Max: i7-8700 65W: 12V @ 11.24A (134.88W), 5V @ 1.14A (5.7W), 3.3V @ 0.25A (0.825W)
OS SUPPORT	Microsoft	Windows 10 IoT Enterprise 64-bit
	Linux	Ubuntu 18.04
ENVIRONMENT	Temperature	Operating: 0 to 60°C Storage: -40 to 85°C
	Humidity	Operating: 5 to 90% RH Storage: 5 to 90% RH
MECHANICAL	MTBF	C246: 639,615 hrs @ 25°C; 393,053 hrs @ 45°C; 259,094 hrs @ 60°C Q370: 639,615 hrs @ 25°C; 393,053 hrs @ 45°C; 259,094 hrs @ 60°C H310: 640,703 hrs @ 25°C; 393,874 hrs @ 45°C; 259,692 hrs @ 60°C Calculation model: Telcordia Issue 4 Environment: GB, GC – Ground Benign, Controlled
	Dimensions	Mini-ITX Form Factor 170mm (6.7") x 170mm (6.7")
CERTIFICATIONS	Height	PCB: 1.6mm Top Side: 20mm Bottom Side: 3mm
		CE, FCC Class B, RoHS

Features

• Watchdog Timer

The Watchdog Timer function allows your application to regularly “clear” the system at the set time interval. If the system hangs or fails to function, it will reset at the set time interval so that your system will continue to operate.

• DDR4

DDR4 delivers increased system bandwidth and improves performance at a lower power than DDR3/DDR2.

• Graphics

The integrated Intel® UHD graphics engine delivers an excellent blend of graphics performance and features to meet business needs. It provides excellent video and 3D graphics with outstanding graphics responsiveness. These enhancements deliver the performance and compatibility needed for today's and tomorrow's business applications. Supports 1 x LVDS, 1 x VGA, and 2 x DP++ interfaces for display outputs.

• PCI Express

PCI Express is a high bandwidth I/O infrastructure that possesses the ability to scale speeds by forming multiple lanes. The PCI Express architecture also supports high performance graphics infrastructure by enhancing the capability of a PCIe x16 Gen 3 at 16GB/s bandwidth.

• Serial ATA

Serial ATA is a storage interface that is compliant with SATA 1.0a specification. With speed of up to 6Gb/s (SATA 3.0), it improves hard drive performance faster than the standard parallel ATA whose data transfer rate is 100MB/s.

• Gigabit LAN

Two Intel® Gigabit LAN controllers (Intel® I210AT PCIe and Intel® I219V PHY) support up to 1Gbps data transmission. (CS100-H310)

Two Intel® Gigabit LAN controllers (Intel® I210AT PCIe and Intel® I219LM PHY) support up to 1Gbps data transmission. (CS100-Q370/C246)

• Audio

The Realtek ALC888S-VD2-GR audio codec provides 7.1-channel High Definition audio output.

• Wake-On-LAN

This feature allows the network to remotely wake up a Soft Power Down (Soft-Off) PC. It is supported via the onboard LAN port or via a PCI LAN card that uses the PCI PME (Power Management Event) signal. However, if your system is in the Suspend mode, you can power-on the system only through an IRQ or DMA interrupt.



Important:

The 5V_standby power source of your power supply must support $\geq 720\text{mA}$.

• Wake-On-USB

This function allows you to use a USB keyboard or USB mouse to wake up a system from the S3 (STR - Suspend To RAM) state.



Important:

If you are using the Wake-On-USB Keyboard/Mouse function for 2 USB ports, the 5V_standby power source of your power supply must support $\geq 1.5\text{A}$. For 3 or more USB ports, the 5V_standby power source of your power supply must support $\geq 2\text{A}$.

• RTC Timer

The RTC installed on the system board allows your system to automatically power-on on the set date and time.

• ACPI STR

The system board is designed to meet the ACPI (Advanced Configuration and Power Interface) specification. ACPI has energy saving features that enables PCs to implement Power Management and Plug-and-Play with operating systems that support OS Direct Power Management. ACPI when enabled in the Power Management Setup will allow you to use the Suspend to RAM function.

With the Suspend to RAM function enabled, you can power-off the system at once by pressing the power button or selecting “Standby” when you shut down Windows® without having to go through the sometimes tiresome process of closing files, applications and operating system. This is because the system is capable of storing all programs and data files during the entire operating session into RAM (Random Access Memory) when it powers-off. The operating session will resume exactly where you left off the next time you power-on the system.



Important:

The 5V_standby power source of your power supply must support $\geq 720\text{mA}$.

- **Power Failure Recovery**

When power returns after an AC power failure, you may choose to either power-on the system manually or let the system power-on automatically.

- **USB**

The CS100-Q370/C246 supports the new USB 3.1 Gen2 and CS100-H310 supports the USB 3.1 Gen1. USB 3.1 Gen2 is capable of running at a maximum transmission speed of up to 10 Gbit/s (1.2 GB/s) and is faster than USB 3.1 Gen1 (5 Gbit/s, or 625 MB/s), USB 2.0 (480 Mbit/s, or 60 MB/s) and USB 1.1 (12Mb/s). USB 3.1 reduces the time required for data transmission, reduces power consumption, and is backward compatible with USB 2.0. It is a marked improvement in device transfer speeds between your computer and a wide range of simultaneously accessible external Plug and Play peripherals.

Chapter 2 - Hardware Installation

Board Layout

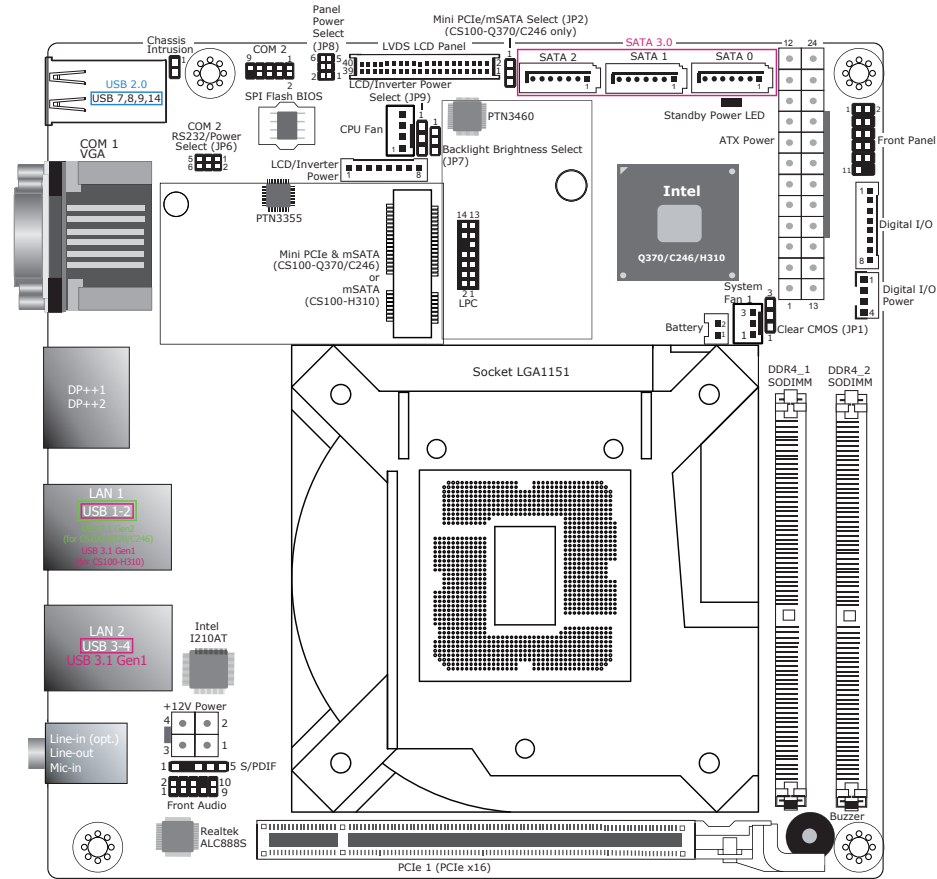

TOP

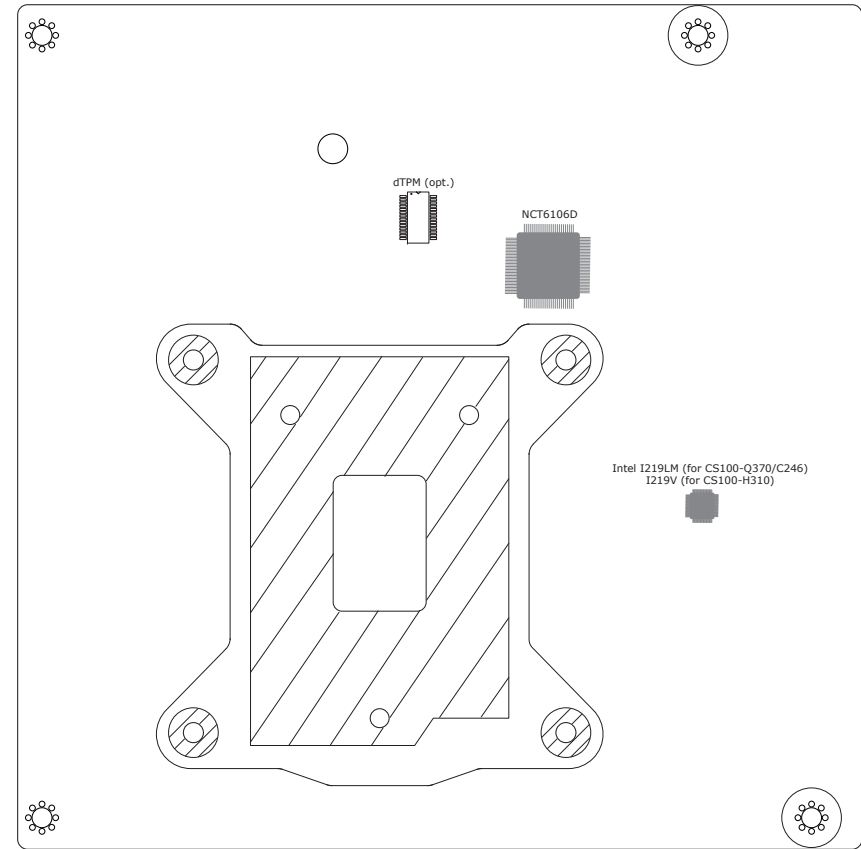

BOTTOM

Block Diagram

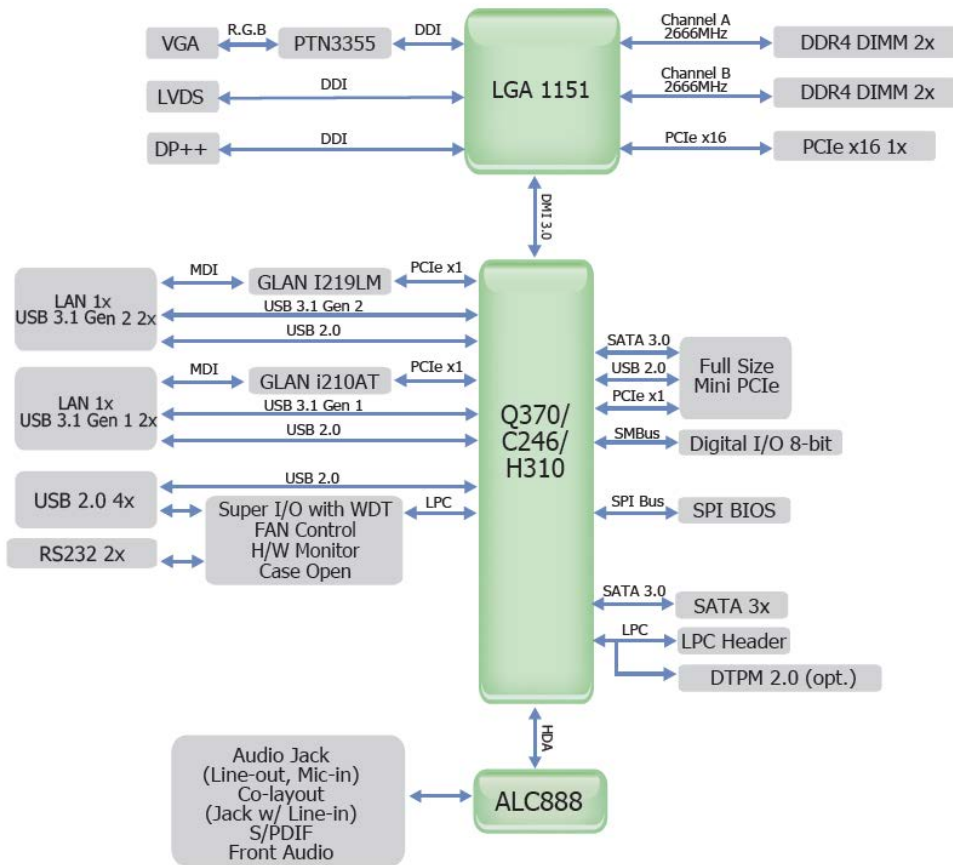

Important:

Electrostatic discharge (ESD) can damage your board, processor, disk drives, add-in boards, and other components. Perform installation procedures at an ESD workstation only. If such a station is not available, you can provide some ESD protection by wearing an antistatic wrist strap and attaching it to a metal part of the system chassis. If a wrist strap is unavailable, establish and maintain contact with the system chassis throughout any procedures requiring ESD protection.

System Memory



Important:

When the Standby Power LED lights red, it indicates that there is power on the system board. Power-off the PC then unplug the power cord prior to installing any devices. Failure to do so will cause severe damage to the motherboard and components.

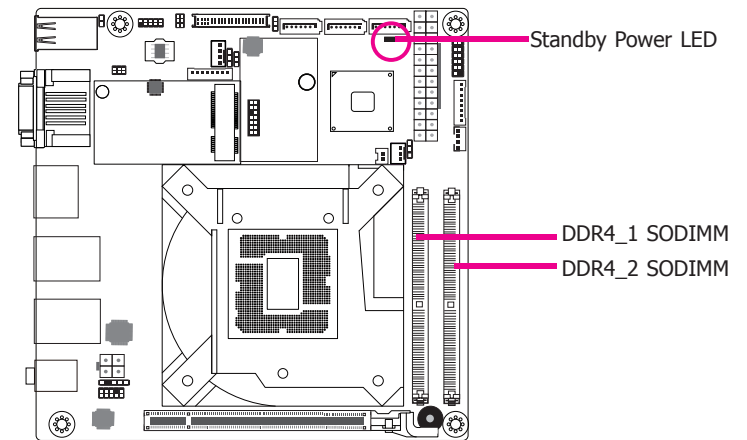

Features

- Two 260-pin SODIMM up to 32GB
- Dual Channel DDR4 2400/2666MHz

The system board supports the following memory interface.

Single Channel (SC)

Data will be accessed in chunks of 64 bits from the memory channels.

Dual Channel (DC)

Data will be accessed in chunks of 128 bits from the memory channels. Dual channel provides better system performance because it doubles the data transfer rate.

Single Channel	DIMMs are on the same channel. DIMMs in a channel can be identical or completely different. However, we highly recommend using identical DIMMs. Not all slots need to be populated.
Dual Channel	DIMMs of the same memory configuration are on different channels.

Installing the SODIMM Module



Note:

The system board used in the following illustrations may not resemble the actual board. These illustrations are for reference only.

1. Make sure the PC and all other peripheral devices connected to it has been powered down.
2. Disconnect all power cords and cables.
3. Locate the SODIMM socket on the system board.
4. Push the “ejector tabs” which are at the ends of the socket to the side.

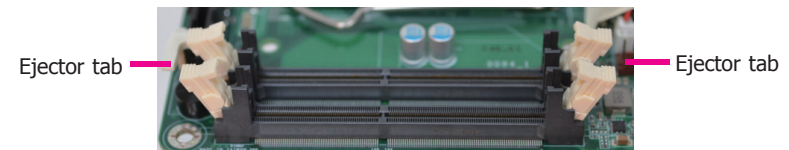

5. Note how the module is keyed to the socket.

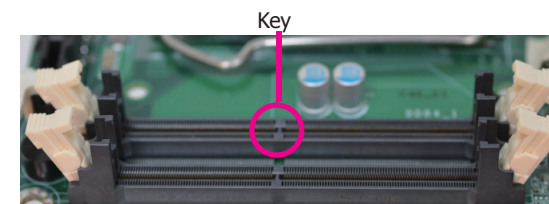
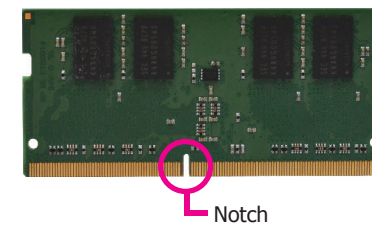

6. Grasping the module by its edges, position the module above the socket with the “notch” in the module aligned with the “key” on the socket. The keying mechanism ensures the module can be plugged into the socket in only one way.

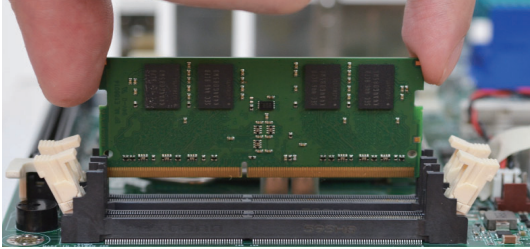

7. Seat the module vertically, pressing it down firmly until it is completely seated in the socket. The ejector tabs at the ends of the socket will automatically snap into the locked position to hold the module in place.

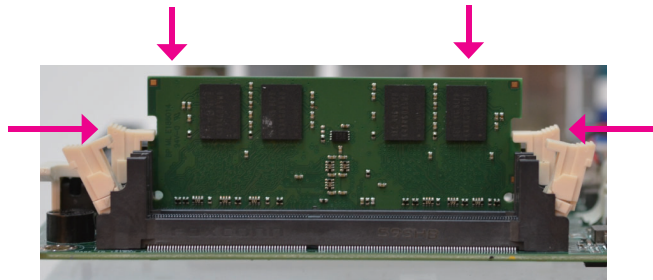

CPU

The system board is equipped with a surface mount LGA 1151 socket. This socket is exclusively designed for installing a LGA 1151 packaged Intel CPU.



Important:

1. Before you proceed, make sure (1) the LGA 1151 socket comes with a protective cap, (2) the cap is not damaged and (3) the socket's contact pins are not bent. If the cap is missing or the cap and/or contact pins are damaged, contact your dealer immediately.
2. Make sure to keep the protective cap. RMA requests will be accepted and processed only if the LGA 1151 socket comes with the protective cap.

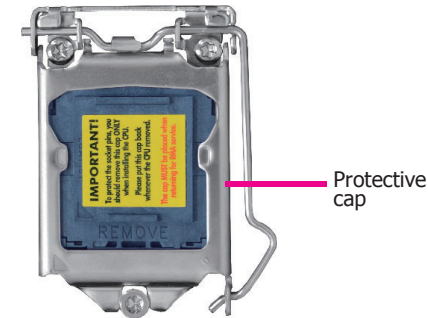

Note:

The system board used in the following illustrations may not resemble the actual board. These illustrations are for reference only.

Installing the CPU

1. Make sure the PC and all other peripheral devices connected to it has been powered down.
2. Disconnect all power cords and cables.
3. Locate the LGA 1151 CPU socket on the system board.

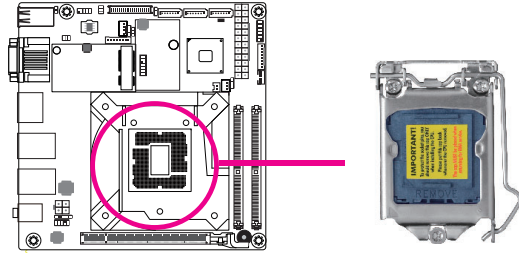

Important:

The CPU socket must not come in contact with anything other than the CPU. Avoid unnecessary exposure. Remove the protective cap only when you are about to install the CPU.

4. Unlock the socket by pushing the load lever down, moving it sideways until it is released from the retention tab; then lift the load lever up.

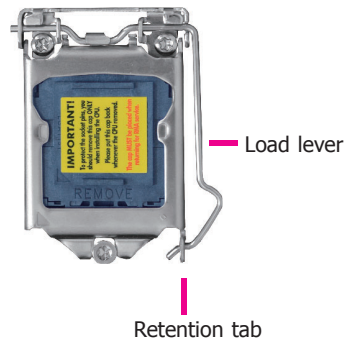

5. Lifting the load lever will at the same time lift the load plate.

Lift the load lever up to the angle shown on the photo.

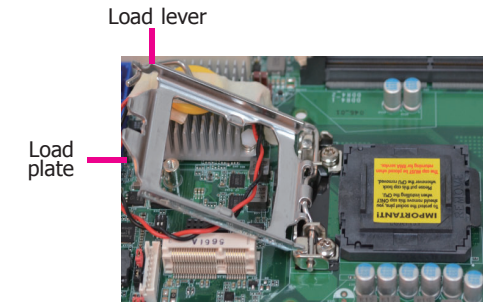

6. Remove the protective cap from the CPU socket. The cap is used to protect the CPU socket against dust and harmful particles. Remove the protective cap only when you are about to install the CPU.

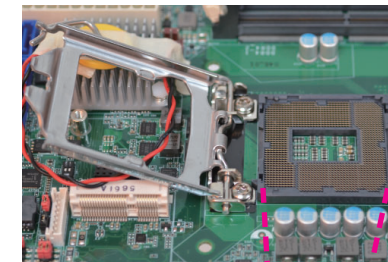

7. Insert the CPU into the socket. The gold triangular mark on the CPU must align with the corner of the CPU socket shown on the photo.

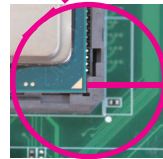
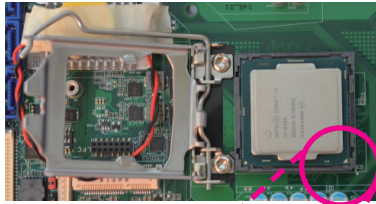

Gold triangular mark

Alignment key

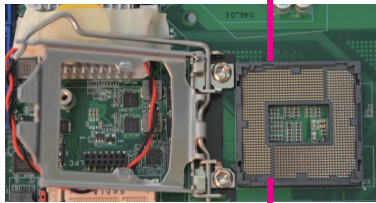

Alignment key

The CPU's notch will at the same time fit into the socket's alignment key.



Important:

The CPU will fit in only one orientation and can easily be inserted without exerting any force.

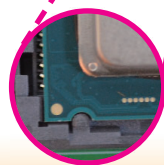
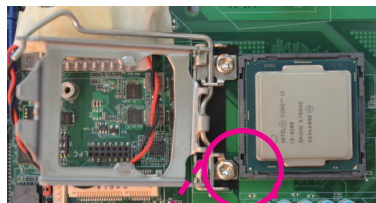

8. Close the load plate then push the load lever down.

While closing the load plate, make sure the front edge of the load plate slides under the retention knob.



Retention knob

9. Hook the load lever under the retention tab.



Load lever

Retention tab

Installing the Fan and Heat Sink

The CPU must be kept cool by using a CPU fan with heat sink. Without sufficient air circulation across the CPU and heat sink, the CPU will overheat damaging both the CPU and system board.



Note:

A boxed Intel® processor already includes the CPU fan and heat sink assembly. If your CPU was purchased separately, make sure to only use Intel®-certified fan and heat sink.

1. Before you install the fan / heat sink, you must apply a thermal paste onto the top of the CPU. The thermal paste is usually supplied when you purchase the fan / heat sink assembly. Do not spread the paste all over the surface. When you later place the heat sink on top of the CPU, the compound will disperse evenly.

Some heat sinks come with a patch of pre-applied thermal paste. Do not apply thermal paste if the fan / heat sink already has a patch of thermal paste on its underside. Peel the strip that covers the paste before you place the fan / heat sink on top of the CPU.

2. Place the heat sink on top of the CPU. The 4 screw around the heat sink, which are used to secure the heat sink onto the system board, must match the 4 mounting holes around the socket.

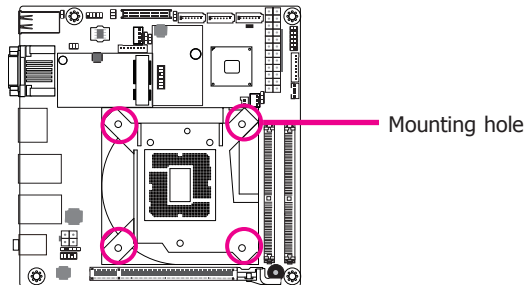

3. Orient the heat sink such that the CPU fan's cable is nearest the CPU fan connector.

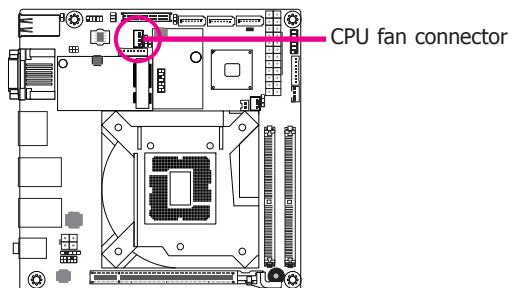

4. Rotate each screw that are diagonally across the heat sink. Perform the same procedure for the other screws.

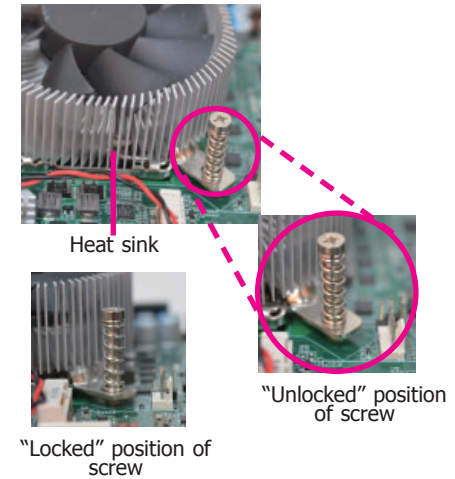

5. Connect the CPU fan's cable to the CPU fan connector on the system board.

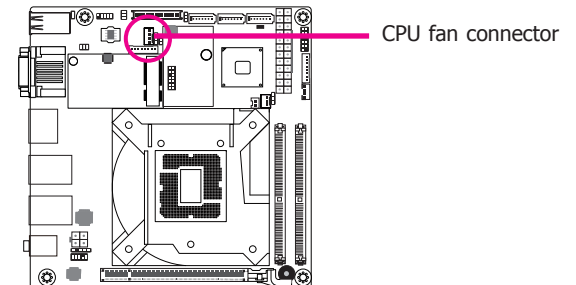

Jumper Settings

Clear CMOS

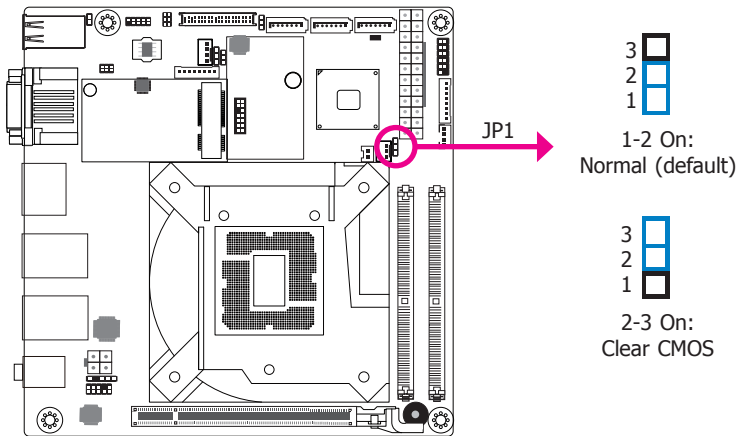

If you encounter the followings,

- a) CMOS data becomes corrupted.
- b) You forgot the supervisor or user password.

you can reconfigure the system with the default values stored in the ROM BIOS.

To load the default values stored in the ROM BIOS, please follow the steps below.

1. Power-off the system and unplug the power cord.
2. Set JP1 pins 2 and 3 to On. Wait for a few seconds and set JP1 back to its default setting, pins 1 and 2 On.
3. Now plug the power cord and power-on the system.

Backlight Brightness Select

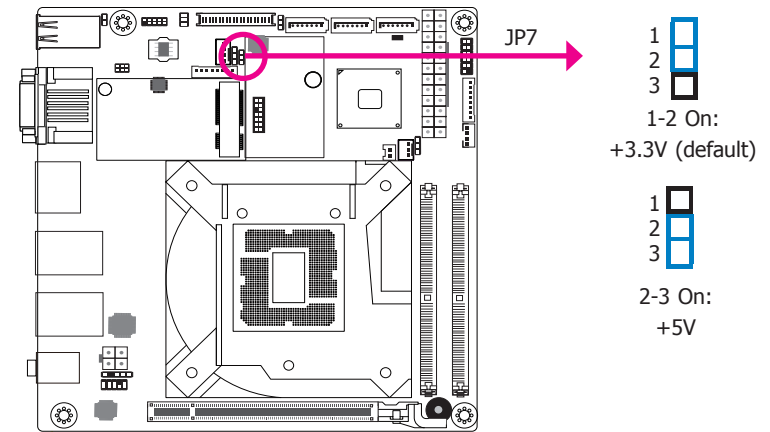

JP7 is used to select the power level of backlight brightness control: +3.3V (default) or +5V.



Important:

Before powering-on the system, make sure that the power settings of JP7 match the power specification of backlight control. Selecting the incorrect voltage will seriously damage the backlight.

COM 2 RS232/Power Select

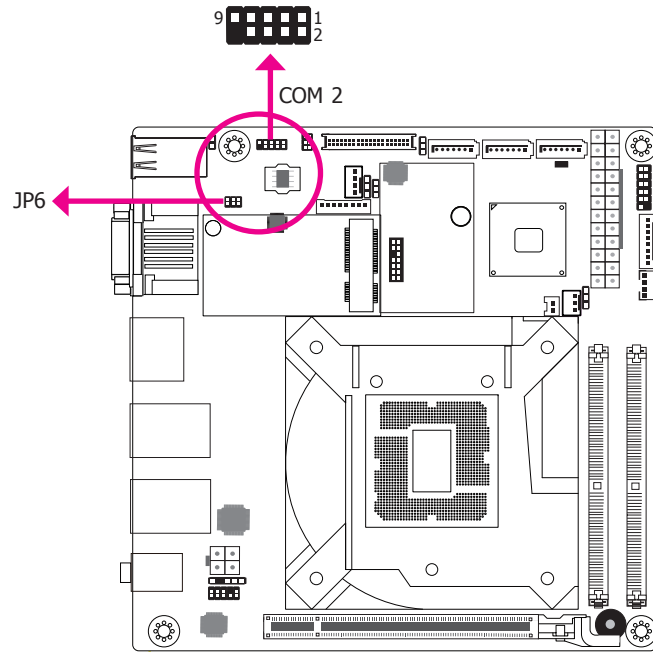

JP6 is used to configure COM 2 to pure RS232 or RS232 with power. The pin functions of COM 2 will vary according to JP6's setting.

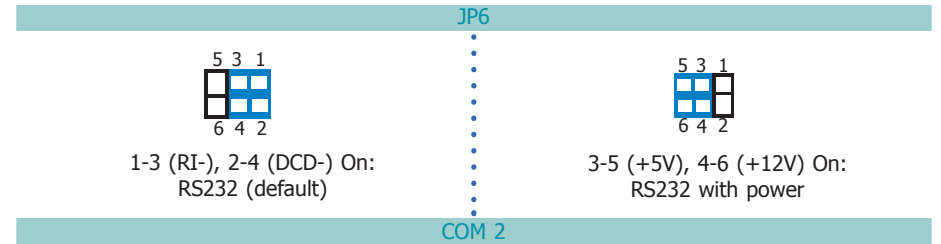

1-3 (RI-), 2-4 (DCD-) On:
RS232 (default)

3-5 (+5V), 4-6 (+12V) On:
RS232 with power



Pin	RS232	RS232 with power
1	DCD-	+12V
2	SIN-	SIN-
3	SO-	SO-
4	DTR-	DTR-
5	GND	GND
6	DSR-	DSR-
7	RTS-	RTS-
8	CTS-	CTS-
9	RI-	+5V

LCD/Inverter Power Select

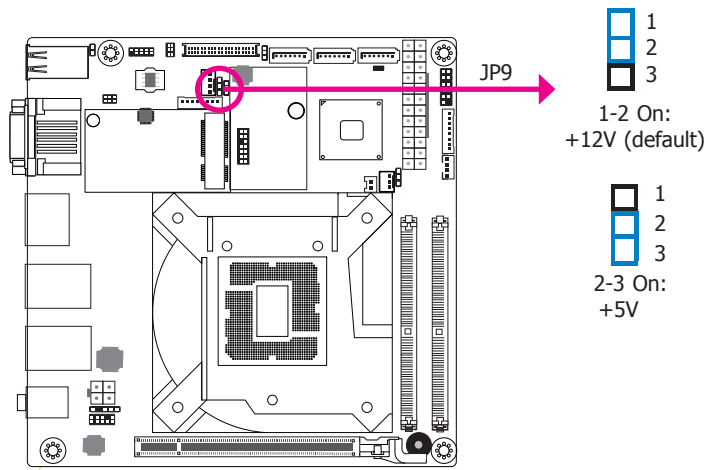

JP9 is used to select the power level of LVDS LCD inverter connector.

Panel Power Select

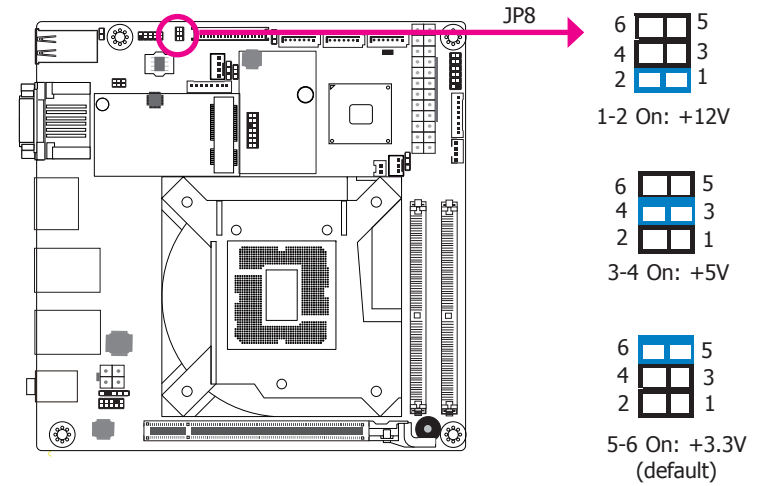

JP8 is used to select the power supplied with the LCD panel.

**Important:**

Before powering-on the system, make sure that the power settings of JP8 match the LCD panel's specification. Selecting the incorrect voltage will seriously damage the LCD panel.

Mini PCIe/mSATA Signal Select (CS100-Q370/C246 only)

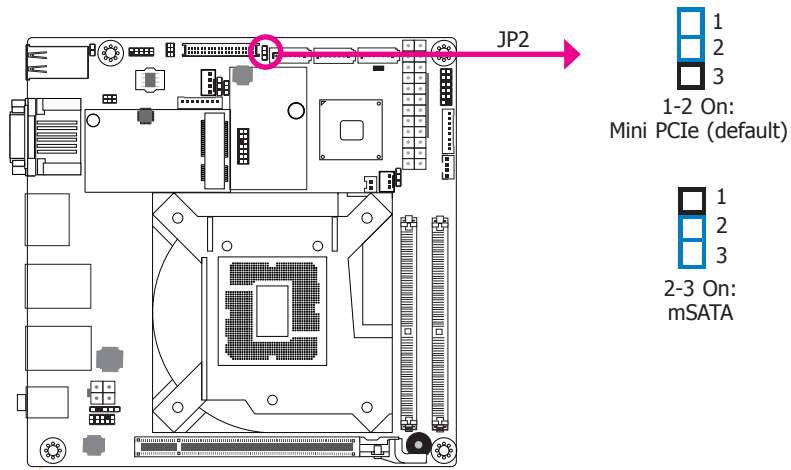

JP2 is used to select the Mini PCIe signal.

Rear Panel I/O Ports

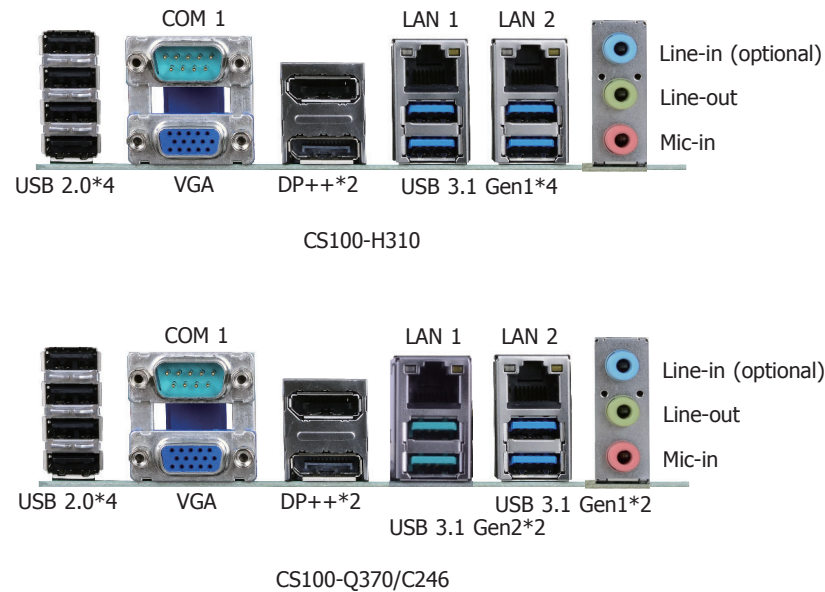

The rear panel I/O ports consist of the following:

- 4 USB 2.0 ports
- 1 Serial COM port
- 1 VGA port
- 2 DP++ ports
- 2 RJ45 LAN ports
- 4 USB 3.1 Gen 1 ports (CS100-H310)
- 2 USB 3.1 Gen 2 ports (CS100-Q370/C246)
- 2 USB 3.1 Gen 1 ports (CS100-Q370/C246)
- 1 Line-in jack (optional)
- 1 Line-out jack
- 1 Mic-in jack

RJ45 LAN Ports

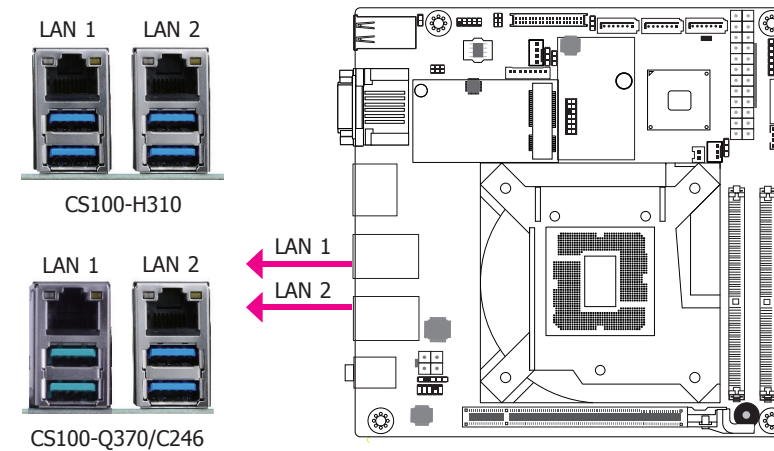

Features

CS100-H310 :

- Intel® I210AT PCIe
- Intel® I219V PHY

CS100-Q370/C246

- Intel® I210AT PCIe
- Intel® I219LM PHY

The two LAN ports allow the system board to connect to a local area network by means of a network hub.

BIOS Setting

Configure the onboard LAN ports in the Chipset menu ("PCH-IO Configuration" submenu) of the BIOS. Refer to the chapter 3 for more information.

Driver Installation

Install the LAN drivers. Refer to the chapter 4 for more information.

USB Ports

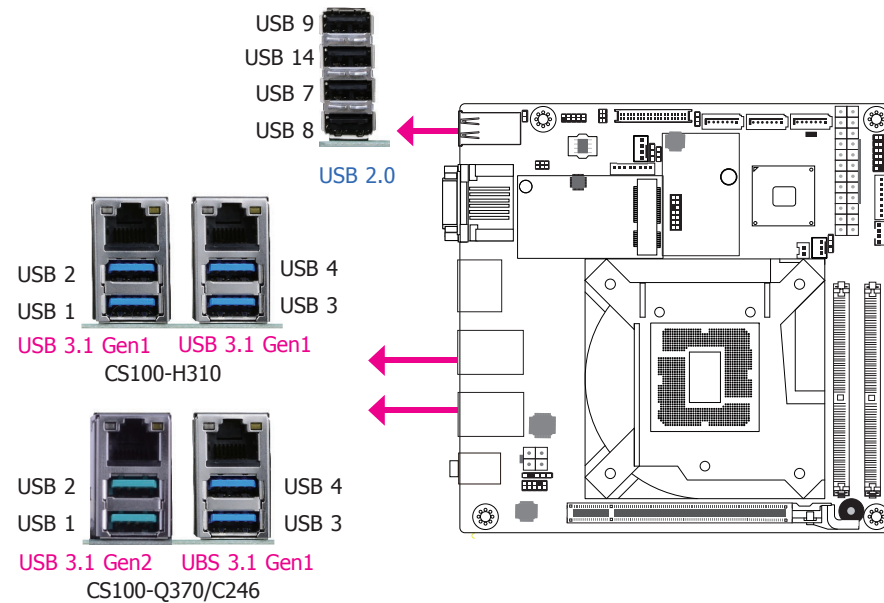

The USB device allows data exchange between your computer and a wide range of simultaneously accessible external Plug and Play peripherals.

The system board is equipped with 4 onboard USB 2.0 ports (USB 7, 8, 9, 14) and 4 onboard USB 3.1 ports (USB 1, 2, 3, 4). The additional USB ports may be mounted on a card-edge bracket. Install the card-edge bracket to an available slot at the rear of the system chassis and then insert the USB port cables to a connector.

BIOS Setting

Configure these onboard USB devices in the Advanced menu ("USB Configuration" submenu) of the BIOS. Refer to the chapter 3 for more information.

Graphics Interfaces

The display ports consist of the following:

- 1 VGA port
- 2 DP++ ports

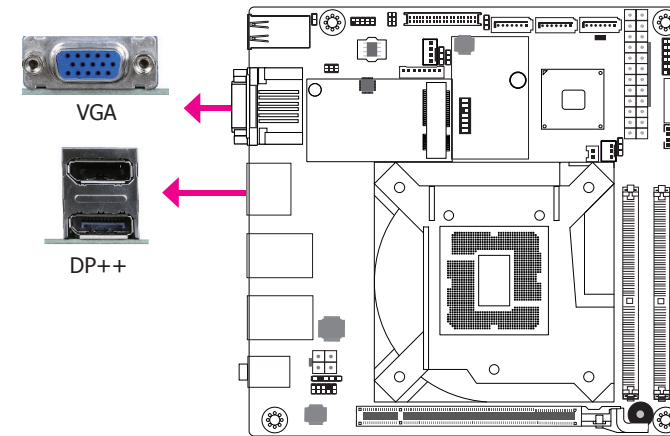

VGA Port

The VGA port is used for connecting a VGA monitor. Connect the monitor's 15-pin D-shell cable connector to the VGA port. After you plug the monitor's cable connector into the VGA port, gently tighten the cable screws to hold the connector in place.

DP++ Port

The DisplayPort is a digital display interface used to connect a display device such as a computer monitor. It is used to transmit audio and video simultaneously. The interface, which is developed by VESA, delivers higher performance features than any other digital interface.

Driver Installation

Install the graphics driver. Refer to the chapter 4 for more information.

COM (Serial) Ports

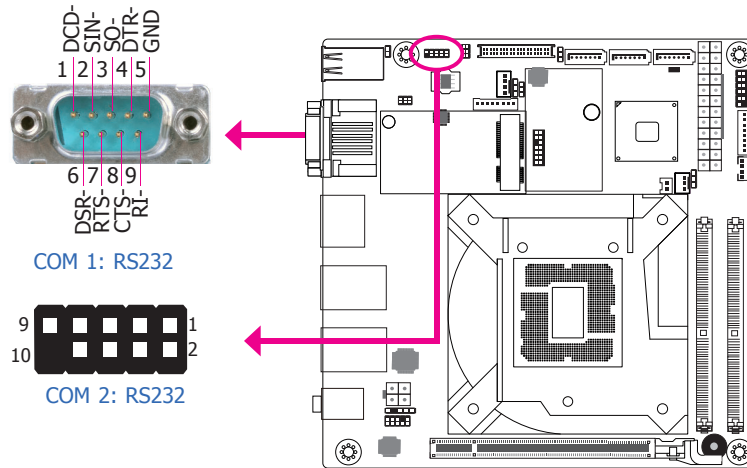

COM 1 and COM 2 are fixed at RS232. Please refer pin functions of COM 1 above.

The pin functions of COM 2 will vary according to JP6's setting. JP6 allows you to configure COM 2 to RS232 or RS232 with power. Refer to "COM 2 RS232/Power Select" in this chapter for more information.

The serial ports are asynchronous communication ports with 16C550A-compatible UARTs that can be used with modems, serial printers, remote display terminals, and other serial devices.

Connecting External Serial Ports

Your COM port may come mounted on a card-edge bracket. Install the card-edge bracket to an available slot at the rear of the system chassis then insert the serial port cable to the COM connector. Make sure the colored stripe on the ribbon cable is aligned with pin 1 of the COM connector.

BIOS Setting

Configure the COM ports 1/2 in the Advanced menu ("NCT6106D Super IO Configuration" submenu) of the BIOS. Refer to the chapter 3 for more information.

Audio

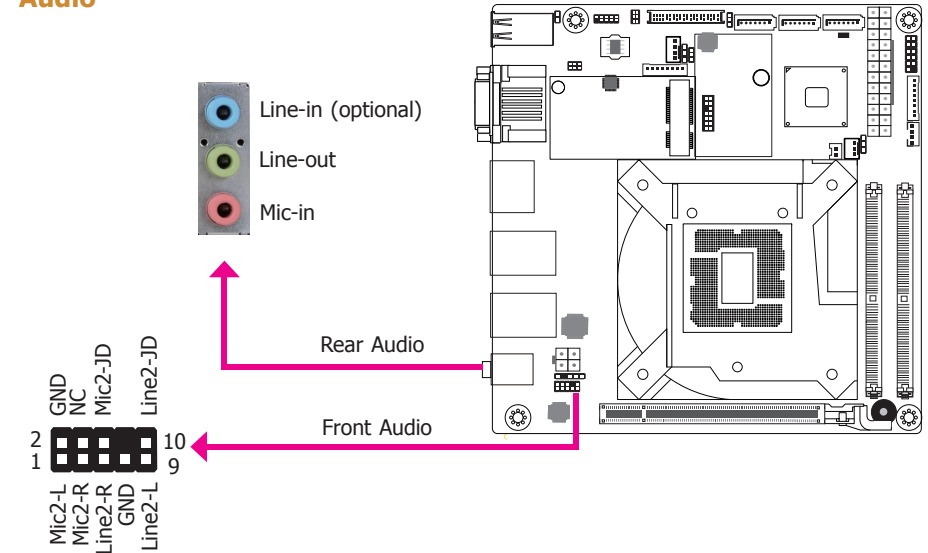

Rear Audio

The system board is equipped with 2 audio jacks (Line-out and Mic-in). Line-in jack is available upon request. A jack is a one-hole connecting interface for inserting a plug.

- Line-in Jack (Light Blue) (optional)
This jack is used to connect any audio devices such as Hi-fi set, CD player, tape player, AM/FM radio tuner, synthesizer, etc.
- Line-out Jack (Lime)
This jack is used to connect a headphone or external speakers.
- Mic-in Jack (Pink)
This jack is used to connect an external microphone.

Front Audio

The front audio connector allows you to connect to the second line-out and mic-in jacks that are at the front panel of your system.

BIOS Setting

Configure the audio settings in the Chipset menu ("PCH-IO Configuration" submenu) of the BIOS. Refer to the chapter 3 for more information.

Driver Installation

Install the audio driver. Refer to the chapter 4 for more information.

I/O Connectors

SATA (Serial ATA) Connectors

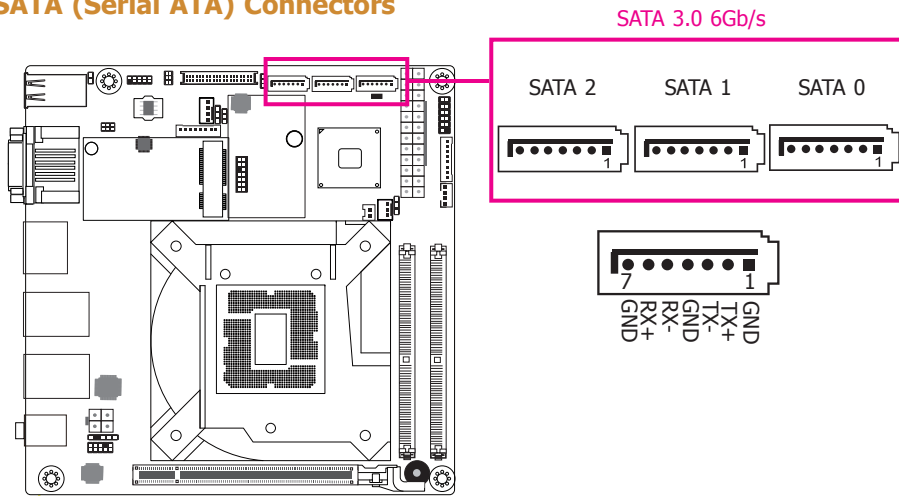

Features

- 3 Serial ATA 3.0 ports with data transfer rate up to 6Gb/s (SATA 0, SATA 1 and SATA 2)
- Integrated Advanced Host Controller Interface (AHCI) controller
- Supports RAID 0, RAID 1 and RAID 5 (for CS100-Q370/C246 only)

The Serial ATA connectors are used to connect Serial ATA devices. Connect one end of the Serial ATA data cable to a SATA connector and the other end to your Serial ATA device.

BIOS Setting

Configure the Serial ATA drives in the Chipset menu ("PCH-IO Configuration" > "SATA And RST Configuration") of the BIOS. Refer to the chapter 3 for more information.

Digital I/O Connector

Digital I/O Power Connector

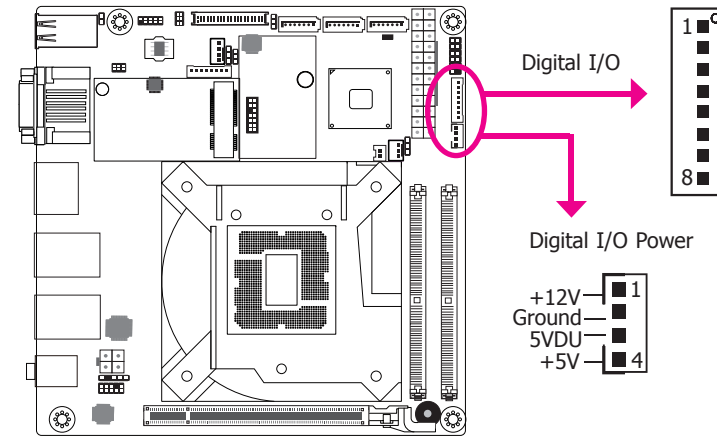

The 8-bit Digital I/O connector provides powering-on function to external devices that are connected to these connectors.

Digital I/O Connector

Pin	Assignment
1	DIO7
2	DIO6
3	DIO5
4	DIO4
5	DIO3
6	DIO2
7	DIO1
8	DIO0

Cooling Fan Connectors

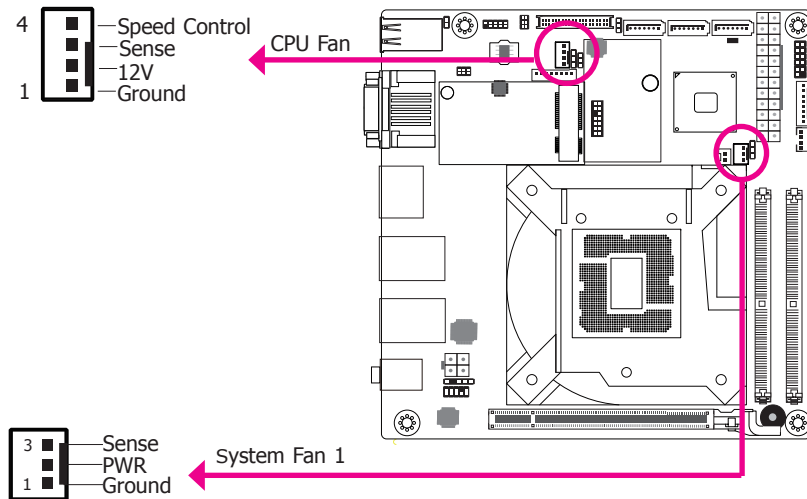

The fan connectors are used to connect cooling fans. The cooling fans will provide adequate airflow throughout the chassis to prevent overheating the CPU and system board components.

BIOS Setting

The Advanced menu ("NCT6106D HW Monitor" submenu) of the BIOS will display the current speed of the cooling fans. Refer to the chapter 3 for more information.

Power Connectors

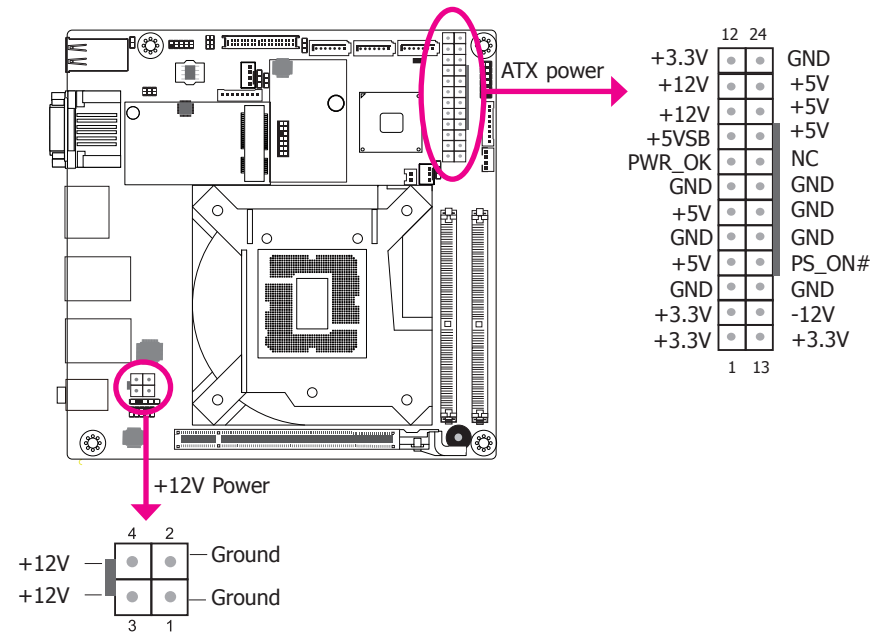

Use a power supply that complies with the ATX12V Power Supply Design Guide Version 1.1. An ATX12V power supply unit has a standard 24-pin ATX main power connector that must be inserted into the 24-pin connector. The 4-pin +12V power connector enables the delivery of more +12VDC current to the processor's Voltage Regulator Module (VRM).

The power connectors from the power supply unit are designed to fit the 24-pin and 4-pin connectors in only one orientation. Make sure to find the proper orientation before plugging the connectors.

The system board requires a minimum of 300 Watt power supply to operate. Your system configuration (CPU power, amount of memory, add-in cards, peripherals, etc.) may exceed the minimum power requirement. To ensure that adequate power is provided, we strongly recommend that you use a minimum of 400 Watt (or greater) power supply.



Important:

Insufficient power supplied to the system may result in instability or the add-in boards and peripherals not functioning properly. Calculating the system's approximate power usage is important to ensure that the power supply meets the system's consumption requirements.

LVDS LCD Panel Connector

LCD/Inverter Power Connector

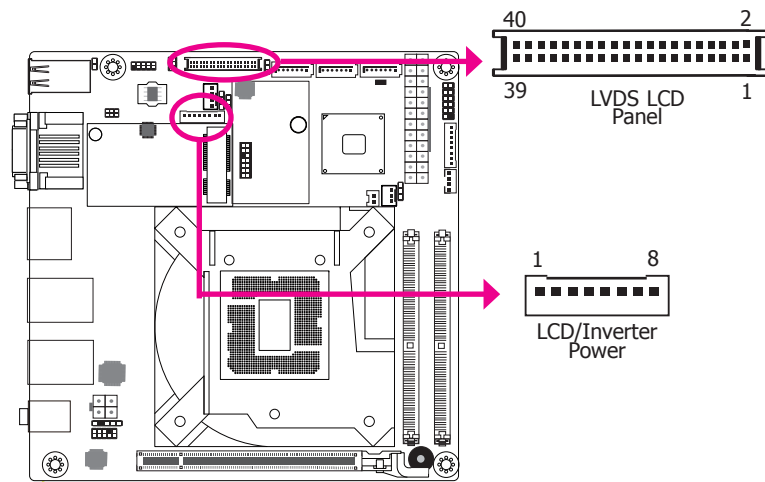

The system board allows you to connect a LCD Display Panel by means of the LVDS LCD panel connector and the LCD/Inverter power connector. These connectors transmit video signals and power from the system board to the LCD Display Panel.

Refer to the right side for the pin functions of these connectors.

Jumper Settings

Refer to the "Jumper Settings" section in this chapter for settings relevant to the LCD panel.

LVDS LCD Panel Connector

Pin	Assignment	Pin	Assignment
1	GND	2	GND
3	LVDSA_Out3+	4	LVDSB_Out3+
5	LVDSA_Out3-	6	LVDSB_Out3-
7	GND	8	GND
9	LVDSA_Out2+	10	LVDSB_Out2+
11	LVDSA_Out2-	12	LVDSB_Out2-
13	GND	14	GND
15	LVDSA_Out1+	16	LVDSB_Out1+
17	LVDSA_Out1-	18	LVDSB_Out1-
19	GND	20	GND
21	LVDSA_Out0+	22	LVDSB_Out0+
23	LVDSA_Out0-	24	LVDSB_Out0-
25	GND	26	GND
27	LVDSA_CLK+	28	LVDSB_CLK+
29	LVDSA_CLK-	30	LVDSB_CLK-
31	GND	32	GND
33	DDC_CLK	34	NC
35	DDC_DATA	36	+3.3V
37	Panel Power	38	Panel Power
39	Panel Power	40	Panel Power

LCD/Inverter Power Connector

Pin	Assignment
1	GND
2	GND
3	Panel Inverter Brightness Voltage Control
4	Panel Power
5	+3.3V
6	Panel Backlight On/Off Control
7	LCD/Inverter Power
8	LCD/Inverter Power



Note:

1. LVDS LCD Panel Connector (DFI PN: 346-714000-204G)
Description: WTB HEADER 40P, 1.25mm, M,H=4.8mm, 180D, SMT, BEIGE, 712-76-40GWEO (PRINEX) RoHS

2. LCD/Inverter Power Connector (DFI PN: 346-510801-100G)
Description: BOX HEADER 1*8, 8P/2.0mm/180D, 721-81-08TW00(PINREX)RoHS

Chassis Intrusion Connector

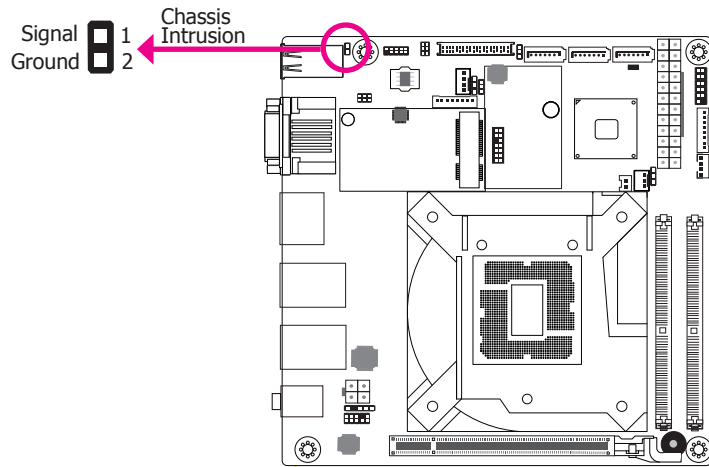

The board supports the chassis intrusion detection function. Connect the chassis intrusion sensor cable from the chassis to this connector. When the system's power is on and a chassis intrusion occurred, an alarm will sound. When the system's power is off and a chassis intrusion occurred, the alarm will sound only when the system restarts.

BIOS Setting

Configure the chassis intrusion detection function in the Advanced menu ("NCT6106D HW Monitor" > "Case Open") of the BIOS. Refer to the chapter 3 for more information.

Front Panel Connector

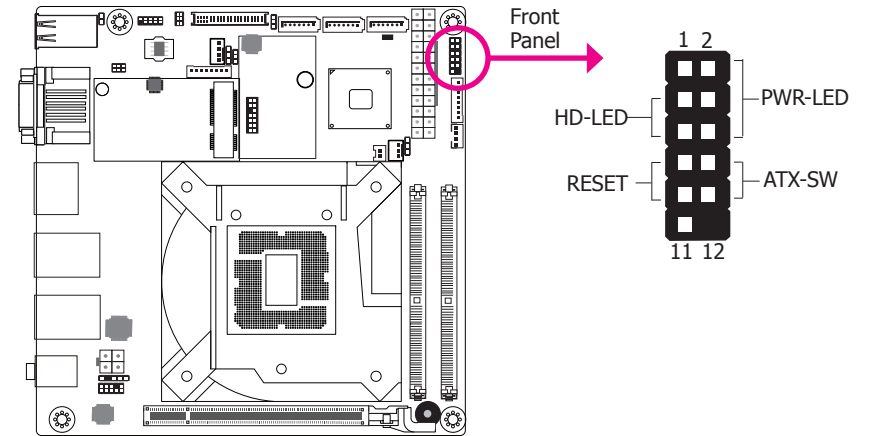

HD-LED - Hard Drive LED

This LED will light when the hard drive is being accessed.

RESET - Reset Switch

This switch allows you to reboot without having to power off the system.

PWR-LED - Power/Standby LED

When the system's power is on, this LED will light. When the system is in the S1 (POS - Power On Suspend) state, it will blink every second. When the system is in the S3 (STR - Suspend To RAM) state, it will blink every 4 seconds.

ATX-SW - ATX Power Switch

This switch is used to power on or off the system.

	Pin	Assignment		Pin	Assignment
	1	NC		2	LED Power
HD-LED	3	HDD Power	PWR-LED	4	LED Power
	5	Signal		6	Signal
RESET	7	Ground	ATX-SW	8	Ground
	9	Signal		10	Signal
	11	NC		12	---

Expansion Slots

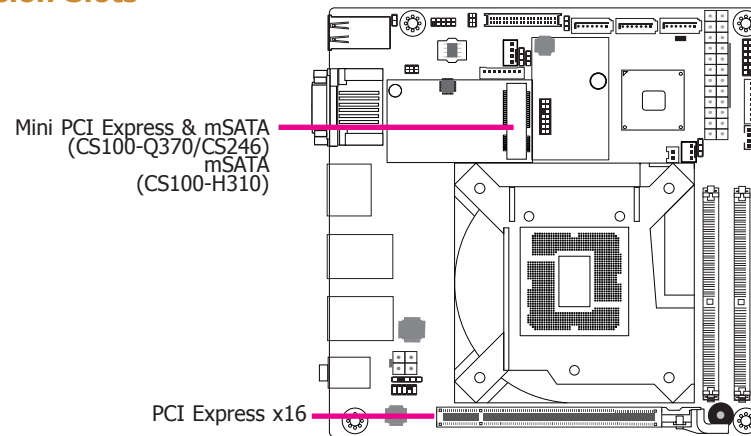

Mini PCI Express Slot

The full-size Mini PCIe socket supports the installation of a Mini PCIe card or an mSATA card.

To switch between these two signals, use JP2. Refer to the “Jumper Settings” section for more information.

PCI Express x16 Slot

Install PCI Express x16 graphics card conformed to the PCI Express specifications, into the PCI Express x16 slot. To install a graphics card into the x16 slot, align the graphics card above the slot then press it down firmly until it is completely seated in the slot. The retaining clip of the slot will automatically hold the graphics card in place.

S/PDIF Connector

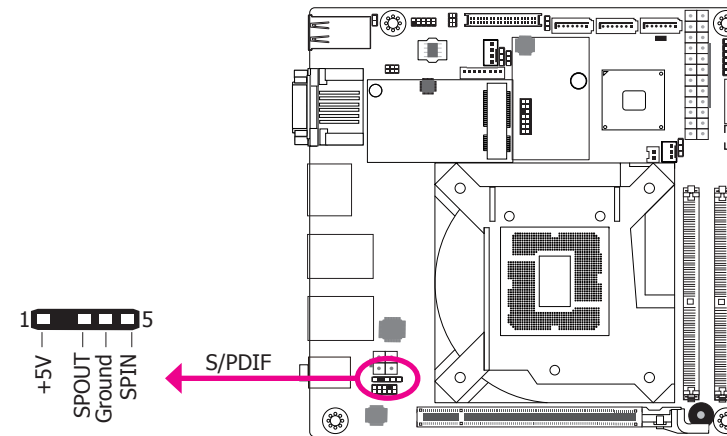

The S/PDIF connector is used to connect an external S/PDIF port. Your S/PDIF port may be mounted on a card-edge bracket. Install the card-edge bracket to an available slot at the rear of the system chassis then connect the audio cable to the S/PDIF connector. Make sure pin 1 of the audio cable is aligned with pin 1 of the S/PDIF connector.

LPC Connector

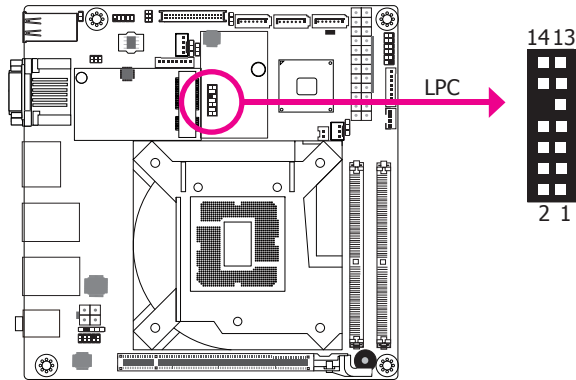

The Low Pin Count Interface was defined by Intel® Corporation to facilitate the industry’s transition towards legacy free systems. It allows the integration of low-bandwidth legacy I/O components within the system, which are typically provided by a Super I/O controller. Furthermore, it can be used to interface firmware hubs, Trusted Platform Module (TPM) devices and embedded controller solutions. Data transfer on the LPC bus is implemented over a 4 bit serialized data interface, which uses a 33MHz LPC bus clock. For more information about LPC bus refer to the Intel® Low Pin Count Interface Specification Revision 1.1’. The table below indicates the pin functions of the LPC connector.

Pin	Assignment	Pin	Assignment
1	L_CLK	2	L_AD1
3	L_RST#	4	L_AD0
5	L_FRAME#	6	3V3
7	L_AD3	8	GND
9	L_AD2	10	---
11	INT_SERIRQ	12	GND
13	5VDU	14	5V

Connecting the EXT-RS232/RS485 Card to the Motherboard

With DFI’s proprietary technology, CS100-Q370/C246/H310 supports two extension modules for additional four COM ports. The EXT-RS232/RS485 card is connected to CS100-Q370/C246/H310 via the LPC connector. The illustrations below guide you how to connect the extension module to the motherboard.

Note: The system board used in the following illustrations may not resemble the actual one. These illustrations are for reference only.

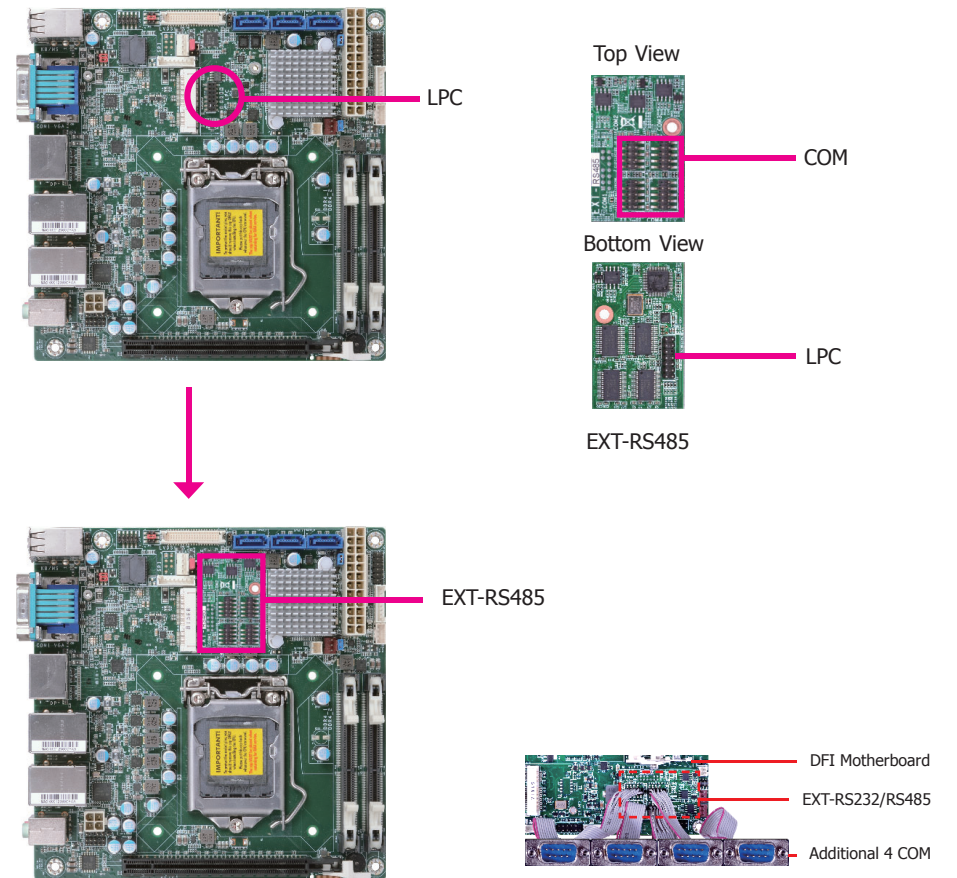

Battery

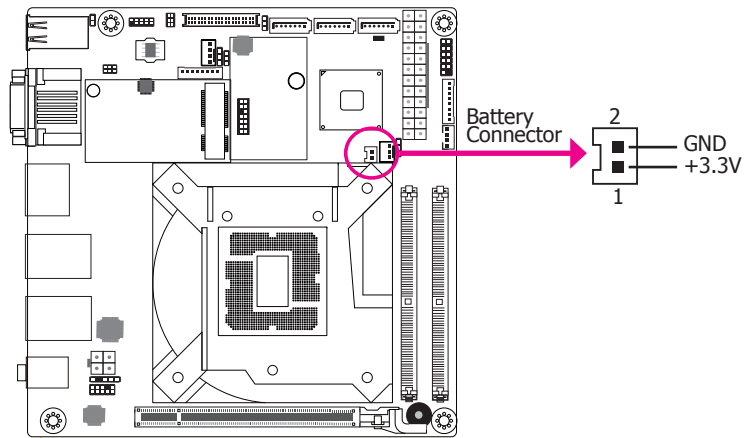

The lithium ion battery powers the real-time clock and CMOS memory. It is an auxiliary source of power when the main power is shut off.

Safety Measures

- Danger of explosion if battery incorrectly replaced.
- Replace only with the same or equivalent type recommended by the manufacturer.
- Dispose of used batteries according to local ordinance.

Chapter 3 - BIOS Setup

Overview

The BIOS is a program that takes care of the basic level of communication between the CPU and peripherals. It contains codes for various advanced features found in this system board. The BIOS allows you to configure the system and save the configuration in a battery-backed CMOS so that the data retains even when the power is off. In general, the information stored in the CMOS RAM of the EEPROM will stay unchanged unless a configuration change has been made such as a hard drive replaced or a device added.

It is possible that the CMOS battery will fail causing CMOS data loss. If this happens, you need to install a new CMOS battery and reconfigure the BIOS settings.



Note:

The BIOS is constantly updated to improve the performance of the system board; therefore the BIOS screens in this chapter may not appear the same as the actual one. These screens are for reference purpose only.

Default Configuration

Most of the configuration settings are either predefined according to the Load Optimal Defaults settings which are stored in the BIOS or are automatically detected and configured without requiring any actions. There are a few settings that you may need to change depending on your system configuration.

Entering the BIOS Setup Utility

The BIOS Setup Utility can only be operated from the keyboard and all commands are keyboard commands. The commands are available at the right side of each setup screen.

The BIOS Setup Utility does not require an operating system to run. After you power up the system, the BIOS message appears on the screen and the memory count begins. After the memory test, the message "Press DEL to run setup" will appear on the screen. If the message disappears before you respond, restart the system or press the "Reset" button. You may also restart the system by pressing the <Ctrl> <Alt> and keys simultaneously.

Legends

Keys	Function
Right and Left arrows	Moves the highlight left or right to select a menu.
Up and Down arrows	Moves the highlight up or down between submenus or fields.
<Enter>	Press <Enter> to enter the highlighted submenu.
+ (plus key)	Scrolls forward through the values or options of the highlighted field.
- (minus key)	Scrolls backward through the values or options of the highlighted field.
<F1>	Displays general help
<F2>	Displays previous values
<F9>	Optimized defaults
<F10>	Saves and resets the setup program.
<Esc>	Exits to the BIOS Setup Utility.

Scroll Bar

When a scroll bar appears to the right of the setup screen, it indicates that there are more available fields not shown on the screen. Use the up and down arrow keys to scroll through all the available fields.

Submenu

When "►" appears on the left of a particular field, it indicates that a submenu which contains additional options are available for that field. To display the submenu, move the highlight to that field and press <Enter>.

AMI BIOS Setup Utility

Main

The Main menu is the first screen that you will see when you enter the BIOS Setup Utility.

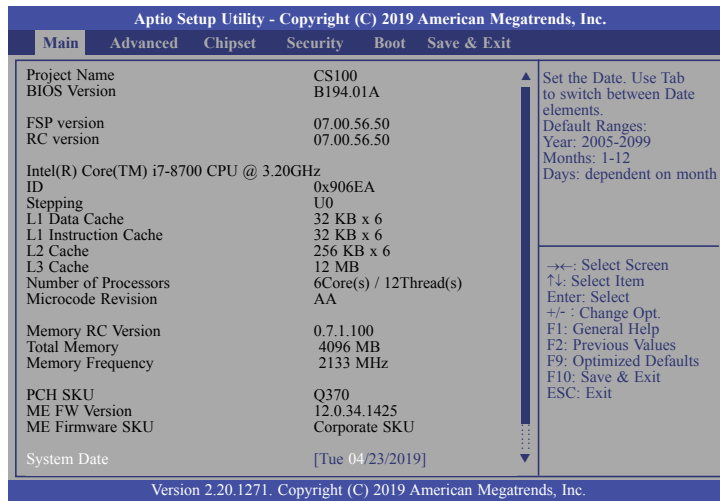

System Date

The date format is <day>, <month>, <date>, <year>. Day displays a day, from Sunday to Saturday. Month displays the month, from 01 to 12. Date displays the date, from 01 to 31. Year displays the year, from 2005 to 2099.

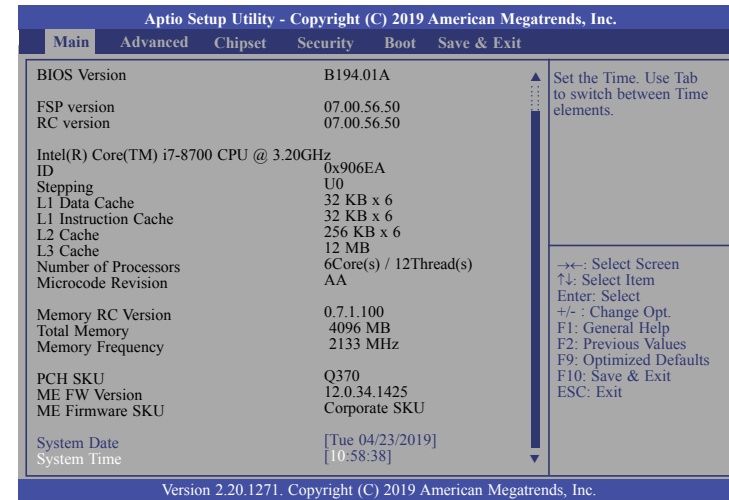

System Time

The time format is <hour>, <minute>, <second>. The time is based on the 24-hour military-time clock. For example, 1 p.m. is 13:00:00. Hour displays hours from 00 to 23. Minute displays minutes from 00 to 59. Second displays seconds from 00 to 59.

Advanced

The Advanced menu allows you to configure your system for basic operation. Some entries are defaults required by the system board, while others, if enabled, will improve the performance of your system or let you set some features according to your preference.



Important:

Setting incorrect field values may cause the system to malfunction.

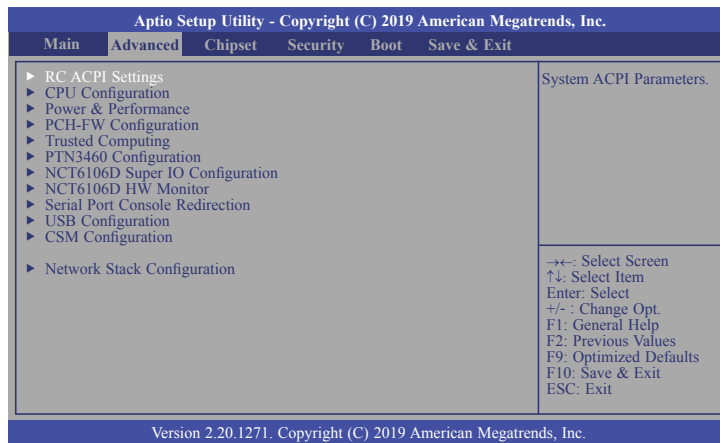

RC ACPI Settings

This section is used to configure the system ACPI parameters.

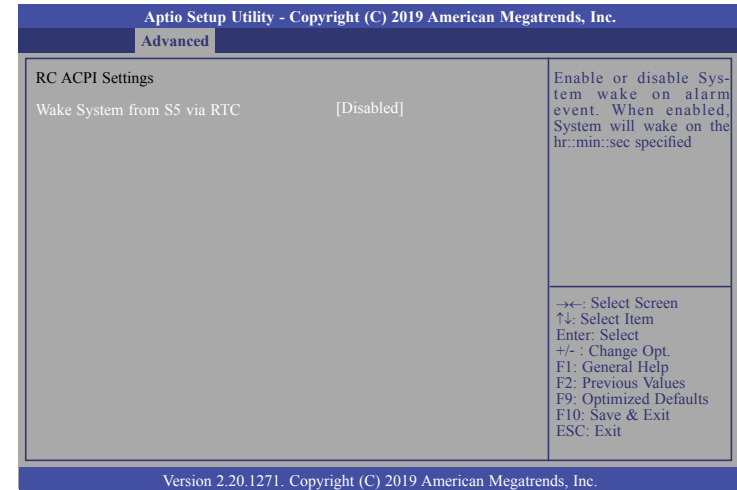

Wake System from S5 via RTC

When Enabled, the system uses the RTC to generate a wakeup event.

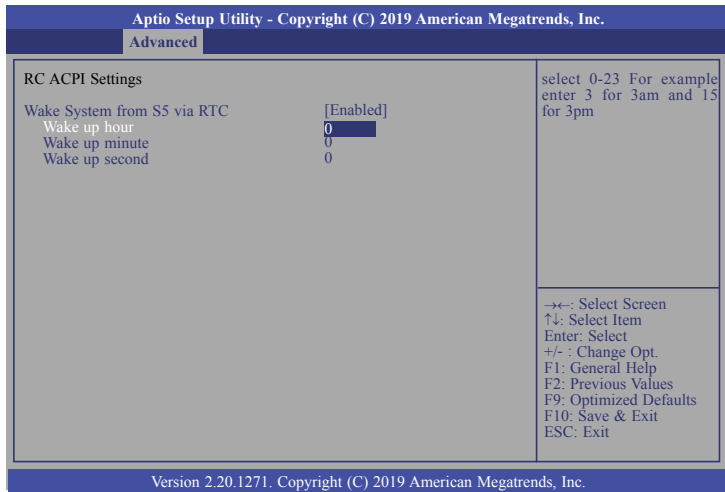

Wake up hour

Set hour from 0 to 23.

Wake up minute

Set minute from 0 to 59.

Wake up second

Set second from 0 to 59.

CPU Configuration

This section is used to configure the CPU.

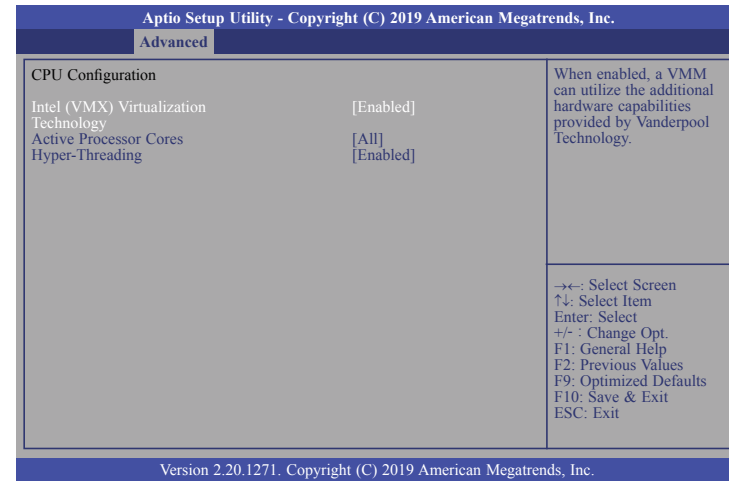

Intel (VMX) Virtualization Technology

When this field is set to Enabled, the VMM can utilize the additional hardware capabilities provided by Vanderpool Technology.

Active Processor Cores

Select number of cores to enable in each processor package: all, 1, 2, 3, 4 or 5.

Hyper-threading

Enables this field for Windows XP and Linux which are optimized for Hyper-Threading technology. Select disabled for other OSes not optimized for Hyper-Threading technology. When disabled, only one thread per enabled core is enabled.

Power & Performance

This section is used to configure the power & performance options.

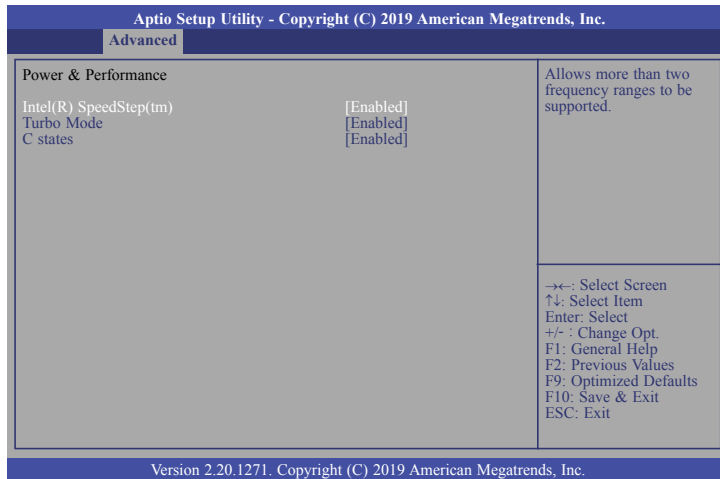

Intel(R) SpeedStep(tm)

This field is used to enable or disable the Intel Enhanced SpeedStep Technology. If enabled, Turbo Mode will appear for configuration.

Turbo Mode

This field is used to enable or disable processor turbo mode (requires that Intel(R) SpeedStep(tm) is enabled too), which allows the processor core to automatically run faster than the base frequency when the processor's power, temperature, and specification are within the limits of TDP.

C states

Enable or disable CPU Power Management. It allows CPU to go to C states when it's not 100% utilized.

PCH-FW Configuration

This section configures the parameters of Management Engine Technology.

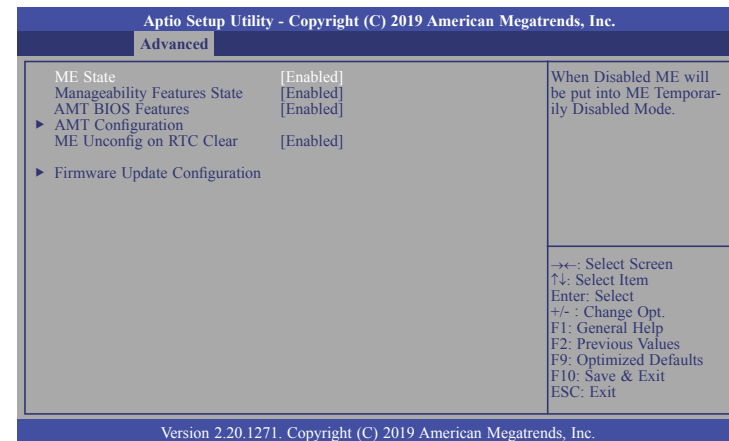

ME State

When this field is set to Disabled, ME will be put into ME Temporarily Disabled Mode.

Manageability Features State

Enable or disable Intel(R) Manageability features. This option disables/enables Manageability Features support in FW. To disable, support platform must be in an unprovisioned state first.

AMT BIOS Features

When disabled, AMT BIOS features are no longer supported and user is no longer able to access MEBx Setup. This option does not disable manageability features in FW.

AMT Configuration

This section is used to configure Intel(R) Active Management Technology Parameters. Refer to the following two pages for more information.

ME Unconfig on RTC Clear

When disabled, ME will not be unconfigured on RTC Clear.

Firmware Update Configuration

This section is used to configure Management Engine Technology Parameters. Refer page 36 for more information.

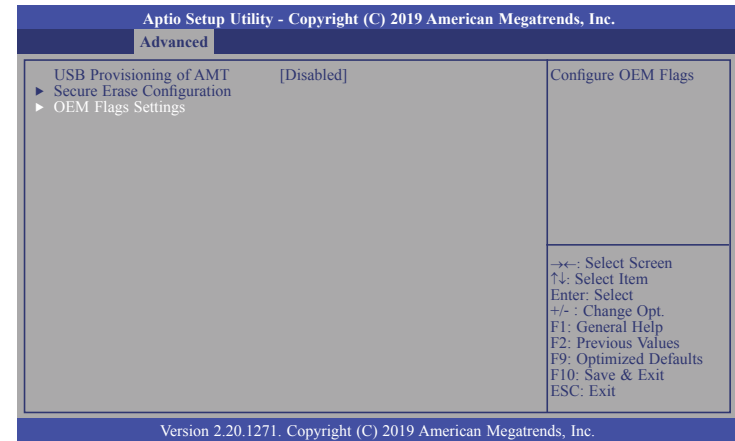
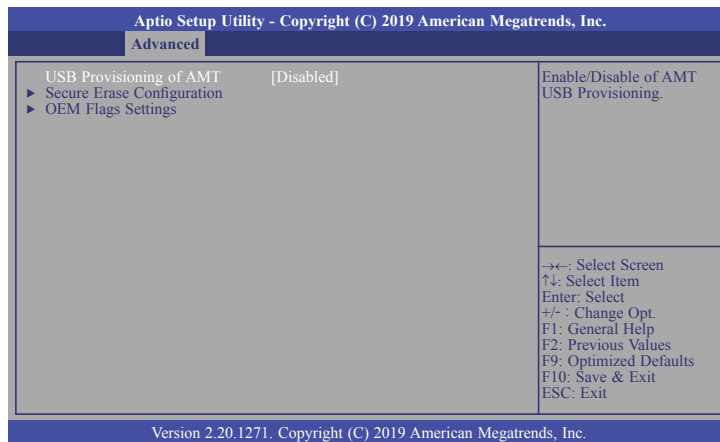
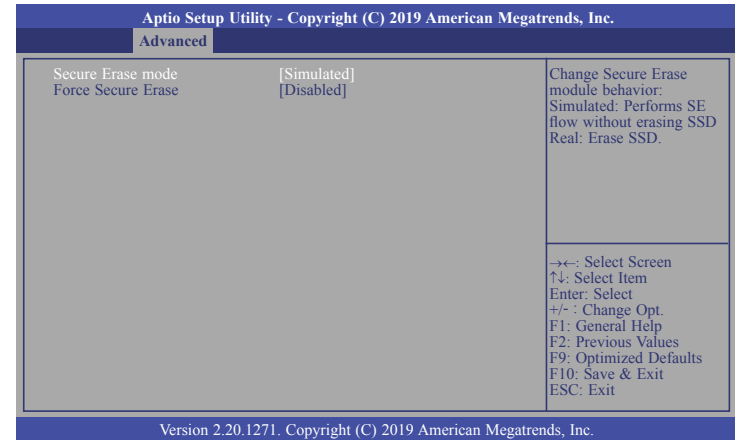
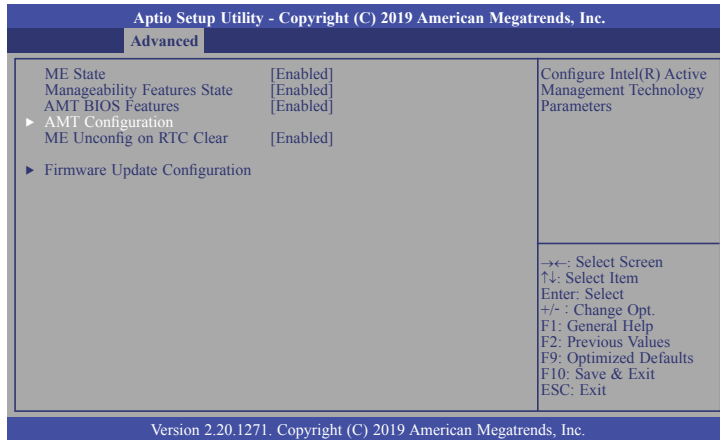

USB Provisioning of AMT

Enable or disable AMT USB Provisioning.

Secure Erase Configuration

This section is used to configure Secure Erase.

Secure Erase Mode

Select Secure Erase module behavior: Simulated or Real.

Force Secure Erase

Enable or disable Force Secure Erase on next boot.

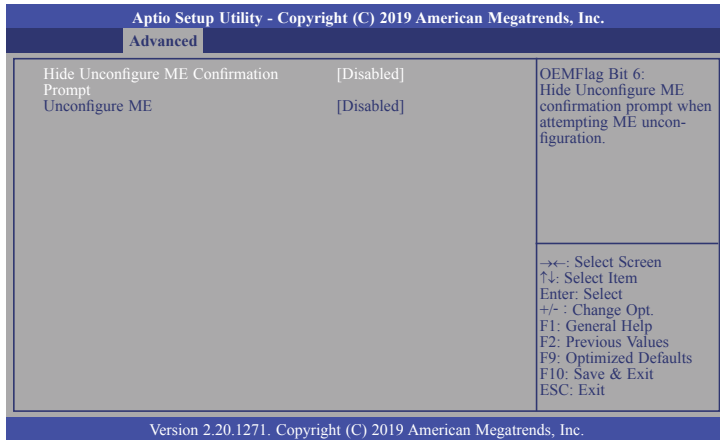

Hide Unconfigure ME Confirmation Prompt

Enable or disable to hide unconfigure ME confirmation prompt when attempting ME unconfiguration.

Unconfigure ME

Enable or disable to unconfigure ME with resetting MEBx password to default.

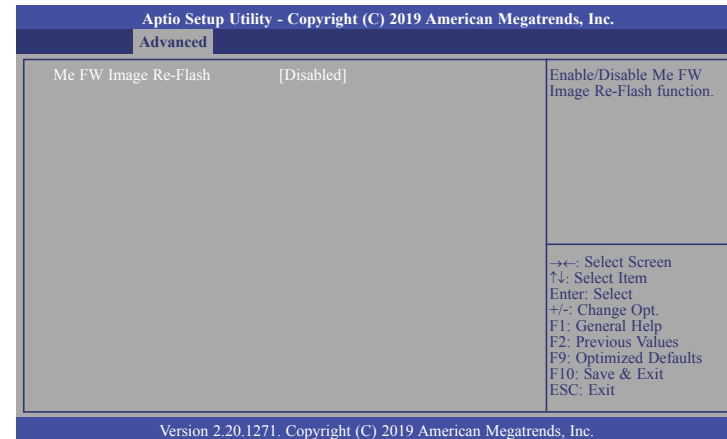
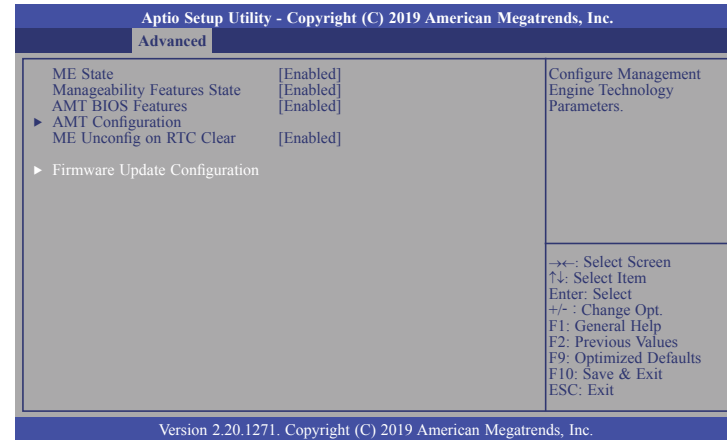

Me FW Image Re-Flash

This field is used to enable or disable the Me FW Image Re-Flash function.

Trusted Computing

This section configures settings relevant to Trusted Computing innovations.

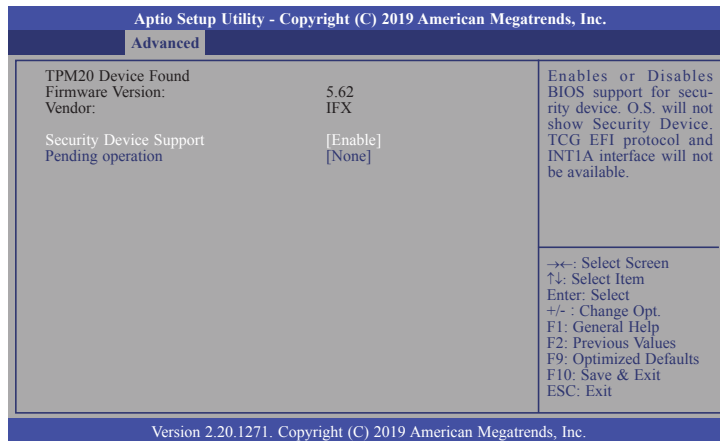

Security Device Support

This field is used to enable or disable BIOS support for the security device. O.S. will not show the security device. TCG EFI protocol and INT1A interface will not be available.

Pending operation

Schedule an operation for the security device. Your computer will reboot during restart in order to change state of the security device.

PTN3460 Configuration

This section is used to configure the PTN3460 Parameters.

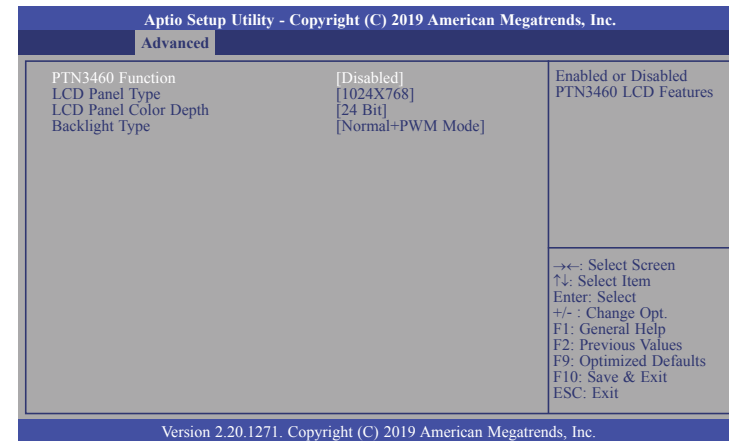

PTN3460 Function

Enable or disable PTN3460 LCD features.

LCD Panel Type

Select LCD Panel Type: 800X480, 800X600, 1024X768, 1366X768, 1280X1024 or 1920X1080.

LCD Panel Color Depth

Select LCD Panel Color Depth: 18 Bit, 24 Bit, 36 Bit or 48 Bit.

Backlight Type

Select Backlight Type Setting: Normal+PWM Mode, Normal+DC Mode, Invert+PWM Mode, or Invert+DC Mode.

NCT6106D Super IO Configuration

This section is used to configure the I/O functions supported by the onboard Super I/O chip.

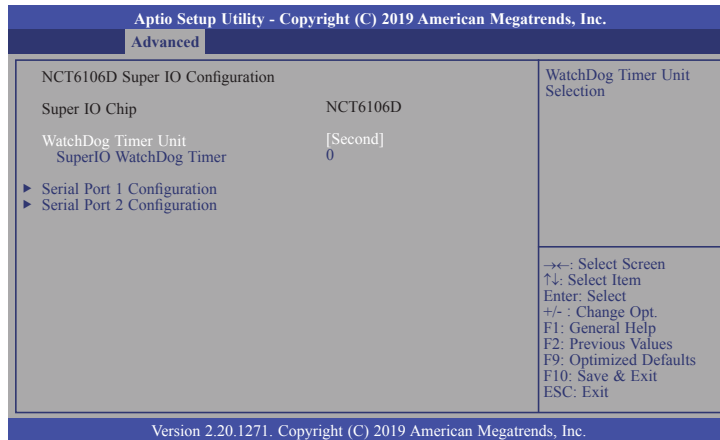

WatchDog Timer Unit

Select WatchDog Timer Unit: Second or Minute.

SuperIO WatchDog Timer

Set SuperIO WatchDog Timer Timeout Value. The range is from 0 (disabled) to 255.

Serial Port 1 Configuration and Serial Port 2 Configuration

Set the parameters of serial port 1 (COMA) and serial port 2 (COMB).

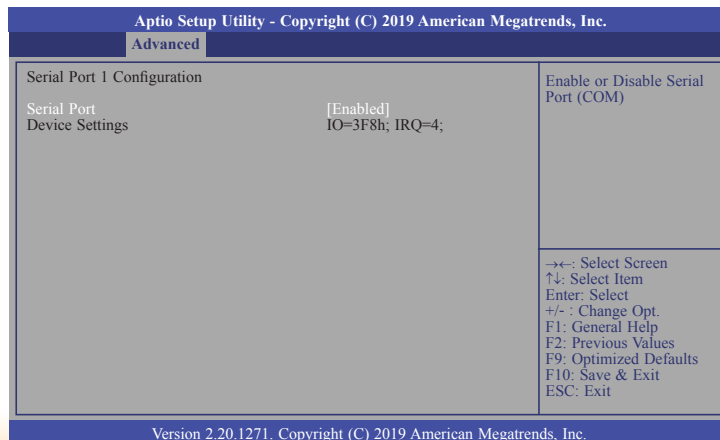

Serial Port

Enable or disable the serial COM port.

NCT6106D HW Monitor

This section displays the hardware health monitor and also configures smart fan and case open functions.

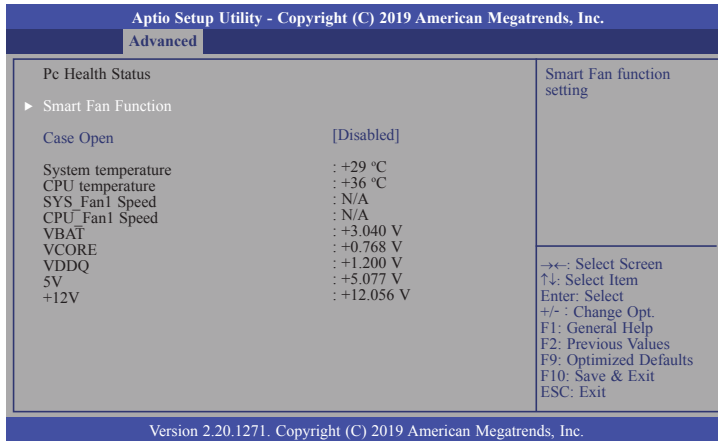

Smart Fan Function

This section is for smart fan function setting.

Case Open

Enable or disable the case open detection function.

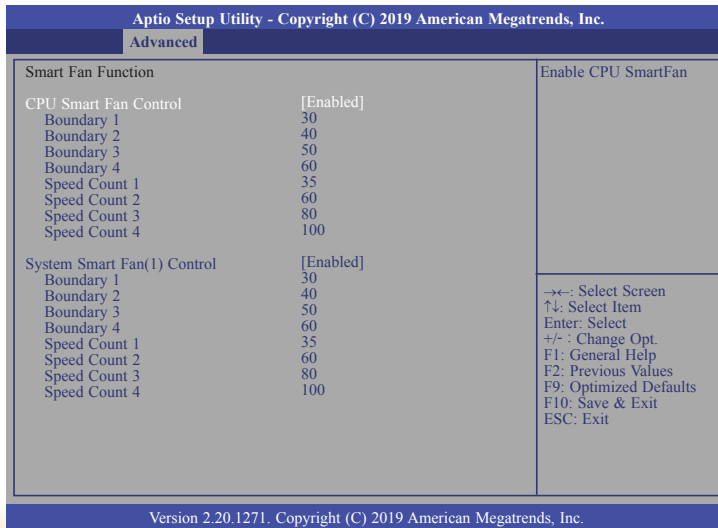

CPU Smart Fan/System Smart Fan(1) Control

Enable or disable the CPU smart fan/system smart fan(1).

Boundary 1 to Boundary 4

Set the boundary temperatures that determine the operation of the fan with different fan speeds accordingly. For example, when the system or the CPU temperature reaches boundary temperature 1, the system or CPU fan should be turned on and operate at the designated speed. The range is from 0-127°C.

Speed Count 1 to Speed Count 4

Set the fan speed. The range is from 1-100% (full speed).



Note:

CPU Smart Fan Control, System Smart Fan(1) Control can be switched to [Disabled]. When they are disabled, "Fix Fan Speed Count" will appear for configuration.

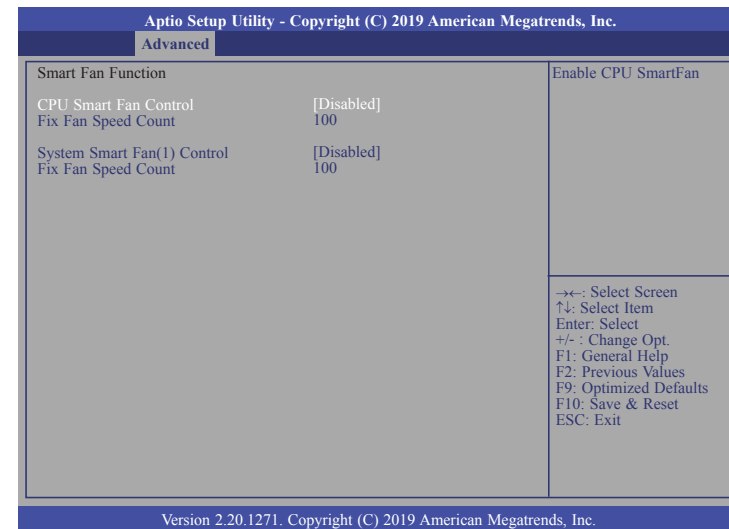

Fix Fan Speed Count

Set the fix fan speed. The range is from 1-100% (full speed).

Serial Port Console Redirection

This section configures settings relevant to serial port console redirection.

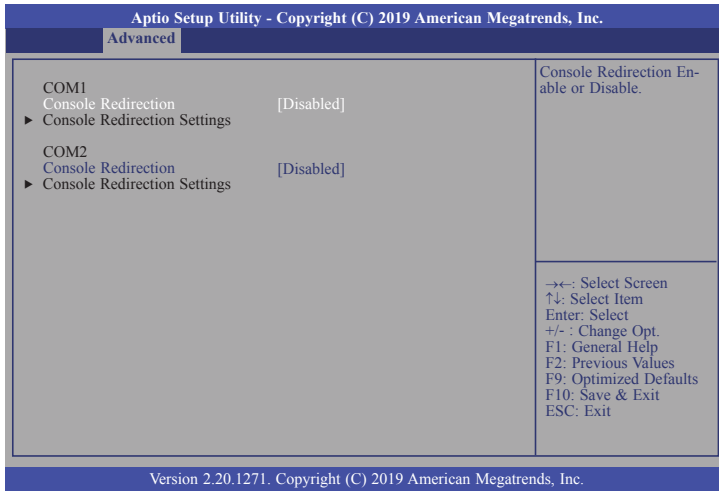

Console Redirection

This field is used to enable or disable the console redirection function. When console redirection is set to enabled, console redirection settings are available like below screen.

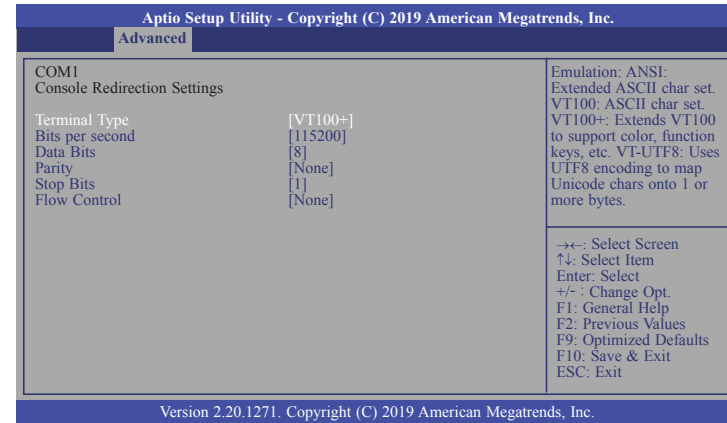
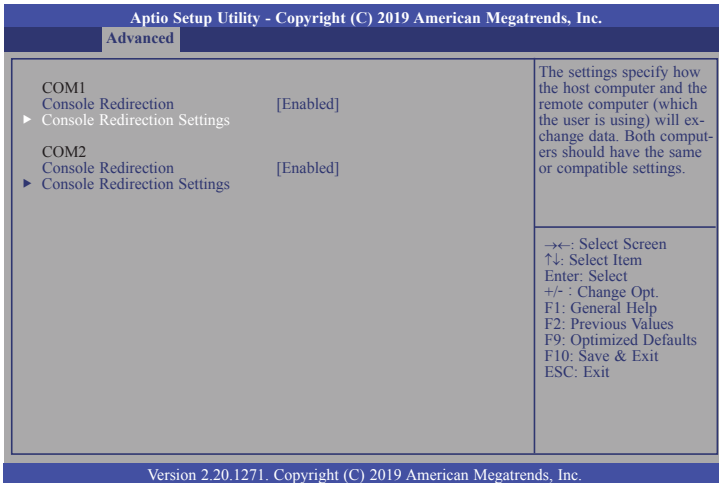

Terminal Type

Select terminal type: VT100, VT100+, VT-UTF8 or ANSI.

Bits per second

Select serial port transmission speed: 9600, 19200, 38400, 57600 or 115200.

Data Bits

Select data bits: 7 bits or 8 bits.

Parity

Select parity bits: None, Even, Odd, Mark or Space.

Stop Bits

Select stop bits: 1 bit or 2 bits.

Flow Control

Select flow control: None or Hardware RTS/CTS.

USB Configuration

This section is used to configure the USB settings.

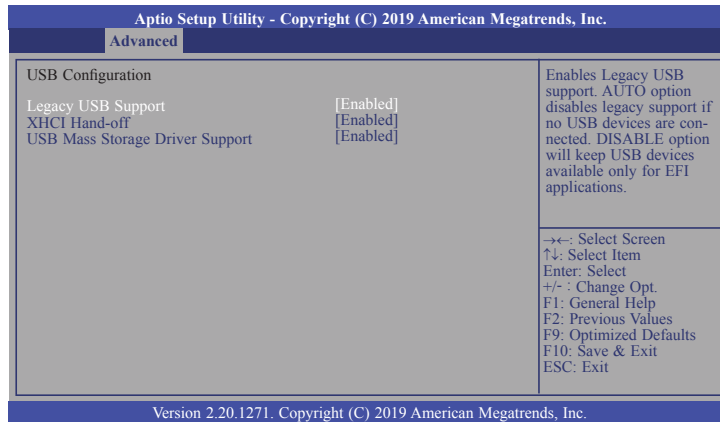

Legacy USB Support

Enabled

Enable Legacy USB support.

Disabled

Keep USB devices available only for EFI applications.

Auto

Disable Legacy support if no USB devices are connected.

XHCI Hand-off

Enable or disable XHCI Hand-off.

USB Mass Storage Driver Support

Enable or disable USB Mass Storage Driver Support.

CSM Configuration

This section is used to configure the CSM settings.

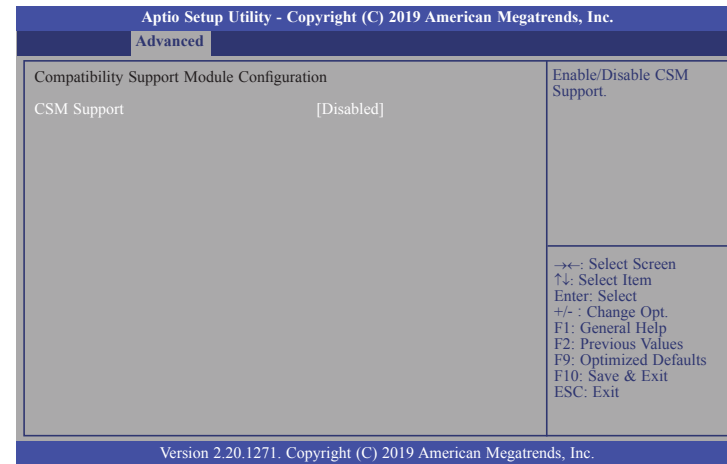

CSM Support

This section is used to enable or disable CSM Support. When CSM Support is set to enabled, several options will appear for configuration.

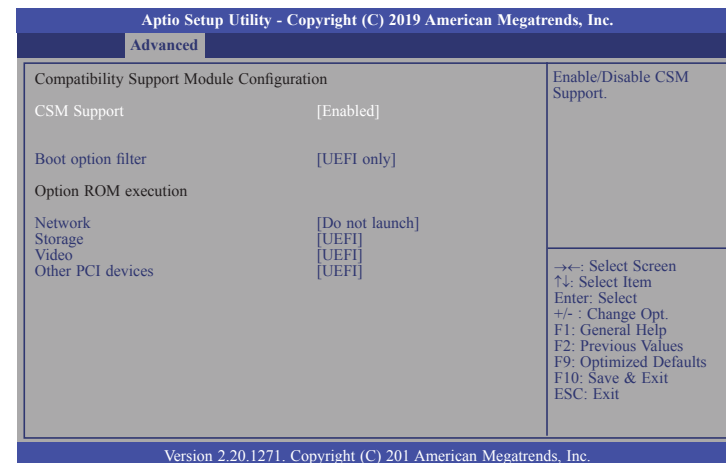

Boot option filter

This field controls Legacy/UEFI ROMs priority.

Network

This field controls the execution of UEFI and Legacy Network OpROM.

Storage

This field controls the execution of UEFI and Legacy Storage OpROM.

Video

This field controls the execution of UEFI and Legacy Video OpROM.

Other PCI devices

This field determines OpROM execution policy for devices other than Network, Storage or Video.

Network Stack Configuration

This section is used to configure the Network Stack settings.

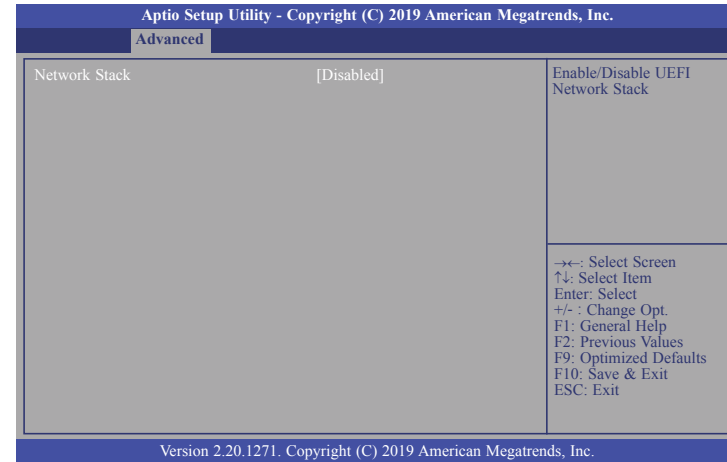

Network Stack

This section is used to enable or disable UEFI network stack. When Network Stack is set to enabled, several options will appear for configuration.

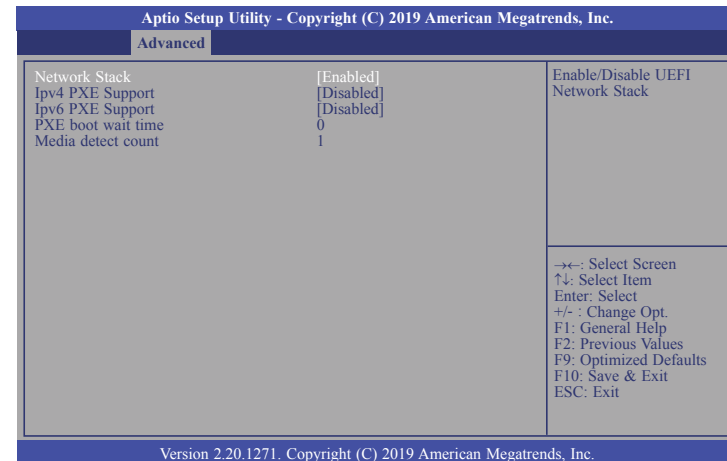

Ipv4 PXE Support

Enable or disable IPv4 PXE boot support. If disabled, IPv4 PXE boot support will not be available.

Ipv6 PXE Support

Enable or disable IPv6 PXE boot support. If disabled, IPv6 PXE boot support will not be available.

PXE boot wait time

Set the wait time in seconds to press ESC key to abort the PXE boot. Use either +/- or numeric keys to set the value.

Media detect count

Set the number of times the presence of media will be checked. Use either +/- or numeric keys to set the value.

Chipset

This section configures relevant chipset functions.

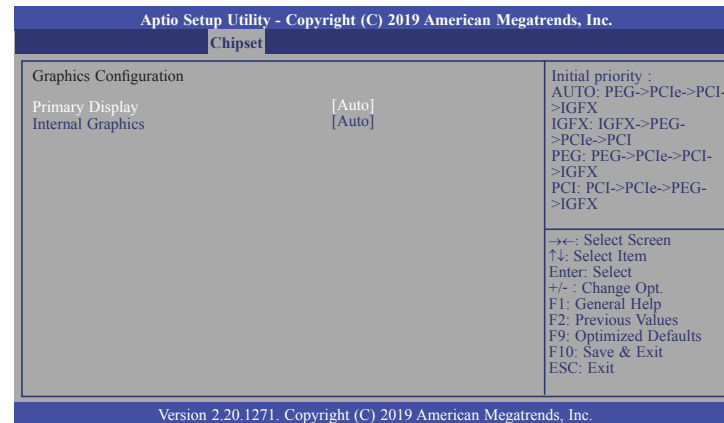
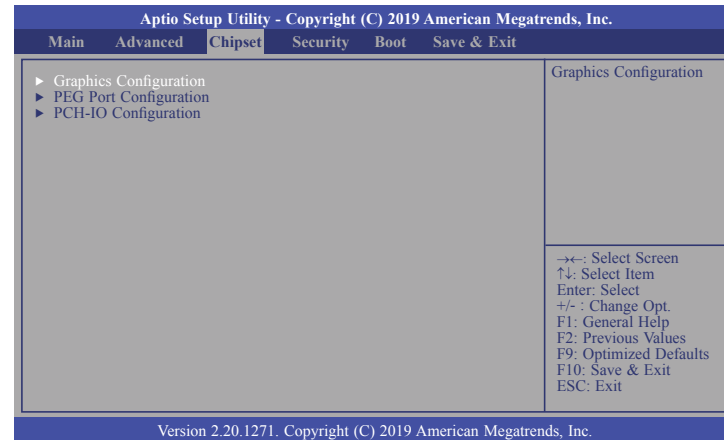
**Primary Display**

Select which of IGFX/PEG/PCI Graphics device to be the primary display.

Internal Graphics

Keep IGFX enabled based on the setup options.

PEG Port Configuration

This section configures the PEG port.

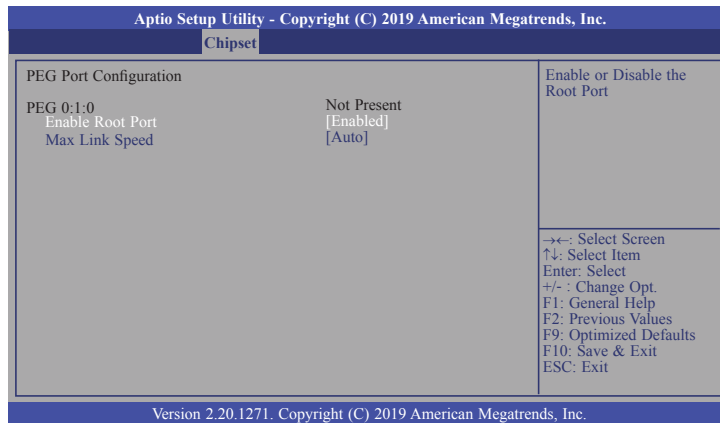

Enable Root Port

Enable or disable the root port.

Max Link Speed

Configure Max Link Speed: Auto, Gen1, Gen2 or Gen3.

PCH-IO Configuration

This section configures the PCH parameters.

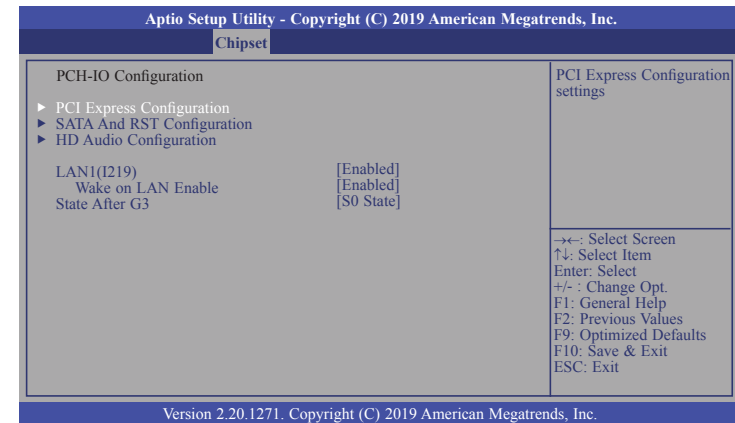

PCI Express Configuration

This section configures PCI Express settings. Refer next page for more information.

SATA And RST Configuration

This section configures SATA Device Options settings. Refer page 46 for more information.

HD Audio Configuration

This section configures HD Audio Subsystem settings. Refer page 46 for more information.

LAN1(I219)

Enable or disable onboard NIC.

Wake on LAN Enable

Enable or disable integrated LAN to wake the system.

State After G3

This field is to specify what state the system should be in when power is re-applied after a power failure (G3, the mechanical-off, state).

S0 State The system is in working state.

S5 State The system is in soft-off state, except for trickle current to devices such as the power button.

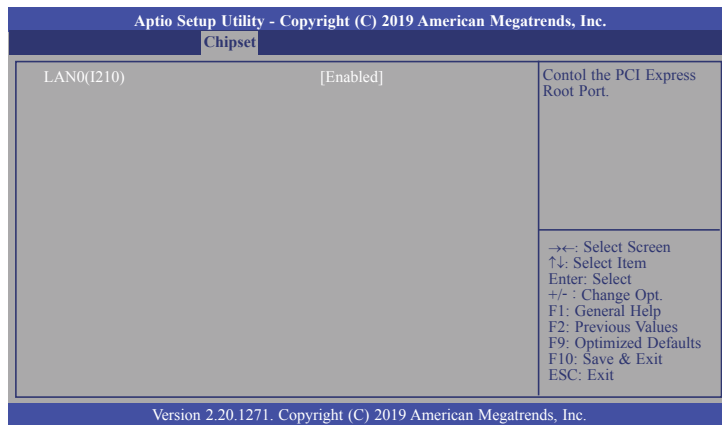
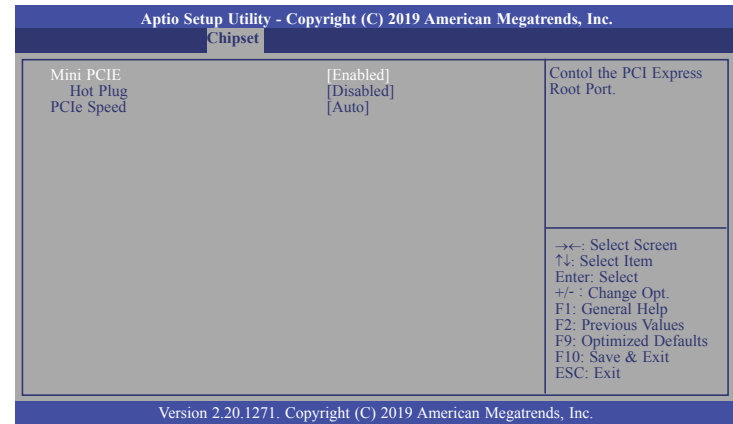
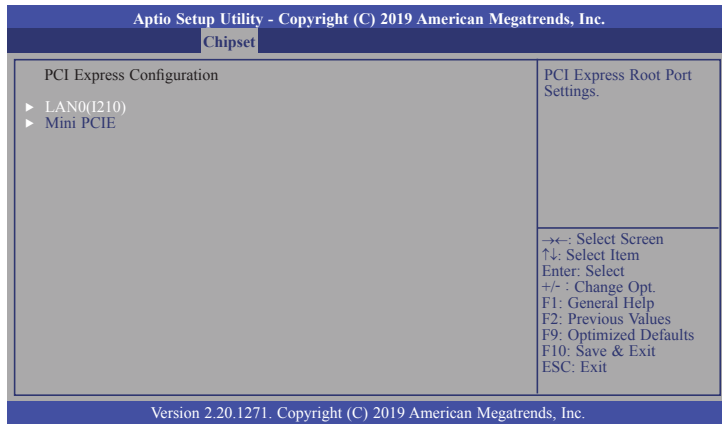

LAN0(I210)/Mini PCIE

This field is used to enable or disable the PCI express root port.

Hot Plug

Enable or disable the hot plug function of the PCI Express root port.

PCIe Speed

Select the speed of the PCI Express root port: Auto, Gen1, Gen2 or Gen3.

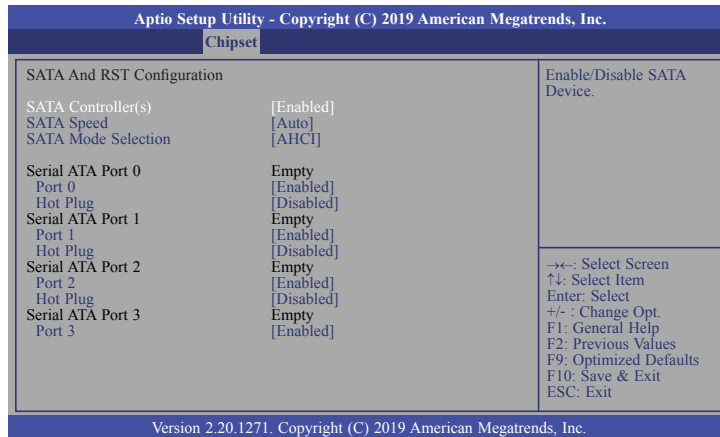

SATA Controller(s)

This field is used to enable or disable the Serial ATA controller.

SATA Speed

Select the speed of the Serial ATA controller: Auto, Gen1, Gen2 or Gen3.

SATA Mode Selection

The mode selection determines how the SATA controller(s) operates.

AHCI

This option allows the Serial ATA controller(s) to use AHCI (Advanced Host Controller Interface).

Intel RST Premium With Intel Optane System Acceleration

This option allows you to create RAID or Intel Rapid Storage configuration with Intel® Optane™ system acceleration on Serial ATA devices.

Serial ATA Port 0/1/2/3 and Hot Plug

Enable or disable the Serial ATA port and its hot plug function.

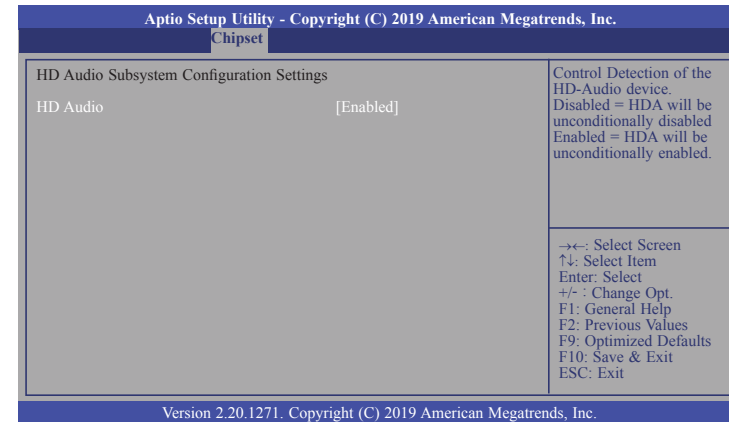

HD Audio

Control the detection of the HD Audio device.

Disabled

HDA will be unconditionally disabled.

Enabled

HDA will be unconditionally enabled.

Security

Aptio Setup Utility - Copyright (C) 2019 American Megatrends, Inc.					
Main	Advanced	Chipset	Security	Boot	Save & Exit
Password Description		Set Administrator Password			
Minimum length	3				
Maximum length	20				
Administrator Password					
				→←: Select Screen ↑↓: Select Item Enter: Select +/-: Change Opt. F1: General Help F2: Previous Values F9: Optimized Defaults F10: Save & Exit ESC: Exit	
Version 2.20.1271. Copyright (C) 2019 American Megatrends, Inc.					

Administrator Password

Set the administrator password.

Boot

Aptio Setup Utility - Copyright (C) 2019 American Megatrends, Inc.					
Main	Advanced	Chipset	Security	Boot	Save & Exit
Boot Configuration		Number of seconds to wait for setup activation key. 65535(0xFFFF) means indefinite waiting.			
Setup Prompt Timeout	1				
Bootup NumLock State	[On]				
Quiet Boot	[Disabled]				
Boot Option Priorities					
Driver Option Priorities					
				→←: Select Screen ↑↓: Select Item Enter: Select +/-: Change Opt. F1: General Help F2: Previous Values F9: Optimized Defaults F10: Save & Exit ESC: Exit	
Version 2.20.1271. Copyright (C) 2019 American Megatrends, Inc.					

Setup Prompt Timeout

Set the number of seconds to wait for the setup activation key. 65535 (0xFFFF) denotes indefinite waiting.

Bootup NumLock State

Select the keyboard NumLock state: On or Off.

Quiet Boot

This section is used to enable or disable quiet boot option.

Boot Option Priorities

Select the system boot order.

Driver Option Priorities

Select the driver boot order.

**Note:**

If "Boot option filter" is set to "UEFI and Legacy" or "UEFI only" and "Quiet Boot" is set to enabled, "BGRT Logo" will show up for configuration. Refer to the Advanced > CSM Configuration for more information.

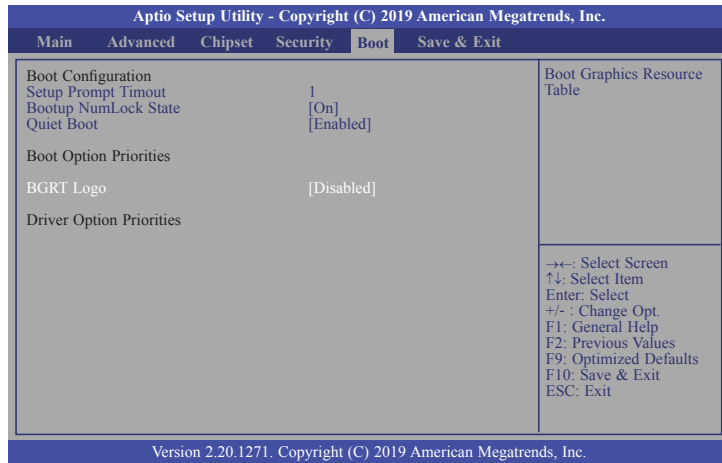
**BGRT Logo**

It is used to enable or disable to support display logo with ACPI Boot Graphics Resource table.

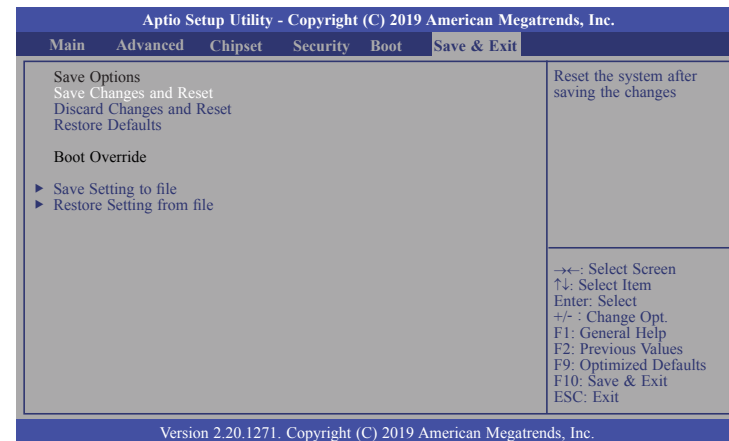
Save & Exit**Save Changes and Reset**

To save the changes, select this field and then press <Enter>. A dialog box will appear. Select Yes to reset the system after saving all changes made.

Discard Changes and Reset

To discard the changes, select this field and then press <Enter>. A dialog box will appear. Select Yes to reset the system setup without saving any changes.

Restore Defaults

To restore and load the optimized default values, select this field and then press <Enter>. A dialog box will appear. Select Yes to restore the default values of all the setup options.

Save Setting to file

Select this option to save BIOS configuration settings to a USB flash device.

Restore Setting from file

Select this field to restore setting from the USB flash device.

Updating the BIOS

To update the BIOS, you will need the new BIOS file and a flash utility. Please contact technical support or your sales representative for the files. You may refer to how-to-video, How to update AMI BIOS in UEFI mode on DFI products?, at <https://www.dfi.com/Knowledge/Video/5> for updating the BIOS steps.

Notice: BIOS SPI ROM

1. The Intel® Management Engine has already been integrated into this system board. Due to the safety concerns, the BIOS (SPI ROM) chip cannot be removed from this system board and used on another system board of the same model.
2. The BIOS (SPI ROM) on this system board must be the original equipment from the factory and cannot be used to replace one which has been utilized on other system boards.
3. If you do not follow the methods above, the Intel® Management Engine will not be updated and will cease to be effective.

**Note:**

- a. You can take advantage of flash tools to update the default configuration of the BIOS (SPI ROM) to the latest version anytime.
- b. When the BIOS IC needs to be replaced, you have to populate it properly onto the system board after the EEPROM programmer has been burned and follow the technical person's instructions to confirm that the MAC address should be burned or not.

Chapter 4 - Supported Software

Please download drivers, utilities and software applications required to enhance the performance of the system board at <https://www.dfi.com/product/index/1410#download>.

Intel Chipset Software Installation Utility

The Intel Chipset Software Installation Utility is used for updating Windows® INF files so that the Intel chipset can be recognized and configured properly in the system.

To install the utility, download "CS100 Chipset Driver" zip file at our website.

1. Setup is ready to install the utility. Click "Next".

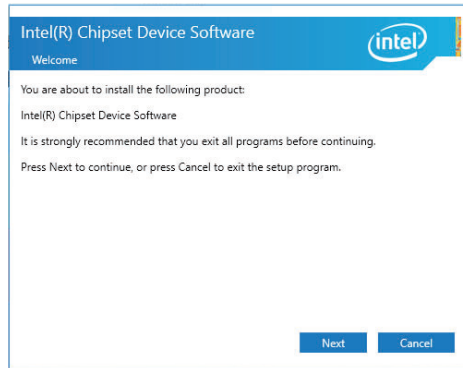

2. Read the license agreement then click "Accept".

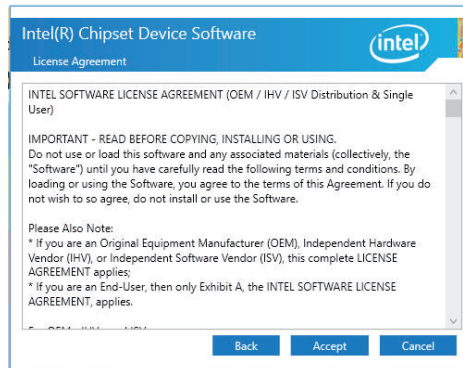

3. Go through the readme document for more installation tips then click "Install".

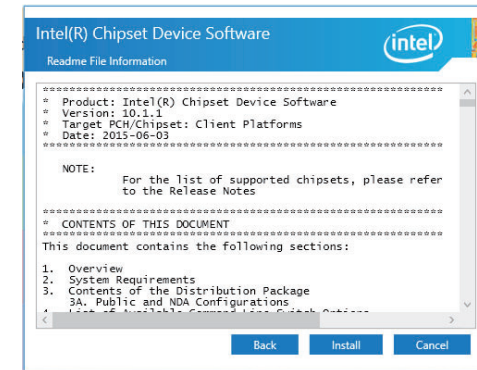

4. The step displays the installing status in the progress.

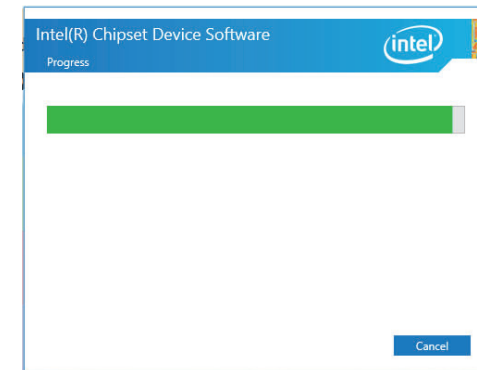

5. After completing installation, click "Restart Now" to exit setup.

Restarting the system will allow the new software installation to take effect.

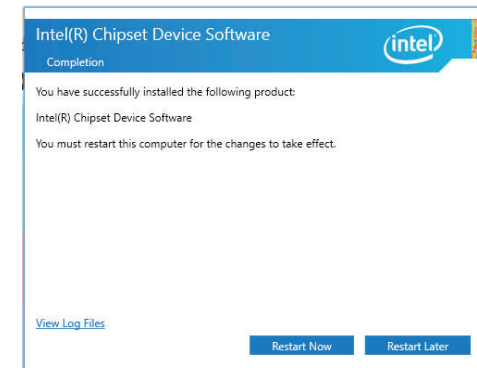

Intel Graphics Driver

To install the driver, download "CS100 Graphics Driver" zip file at our website.

1. Setup is now ready to install the graphics driver. Click "Next".

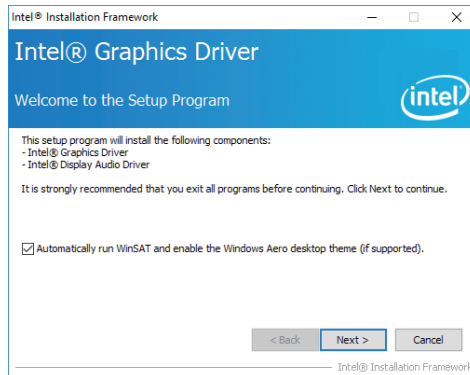

By default, the "Automatically run WinSAT and enable the Windows Aero desktop theme" is enabled. With this enabled, after installing the graphics driver and the system rebooted, the screen will turn blank for 1 to 2 minutes (while WinSAT is running) before the Windows 10 desktop appears. The "blank screen" period is the time Windows is testing the graphics performance.

We recommend that you skip this process by disabling this function then click "Next".

2. Read the license agreement then click "Yes".

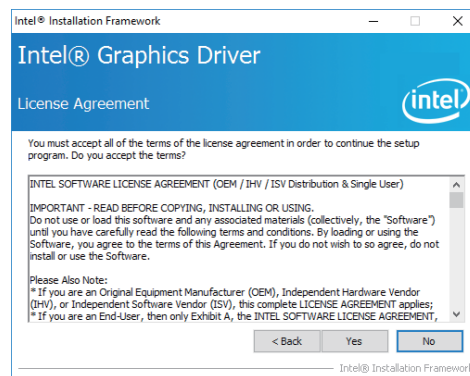

3. Go through the readme document for system requirements and installation tips then click "Next".

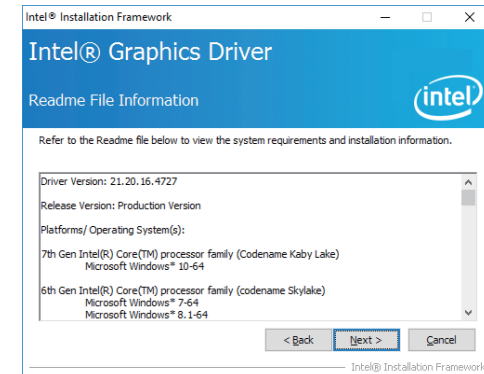

4. Setup is now installing the driver. Click "Next" to continue.

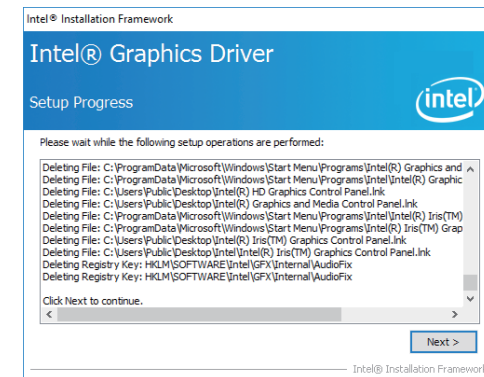

5. Click "Yes, I want to restart this computer now" then click "Finish".

Restarting the system will allow the new software installation to take effect.

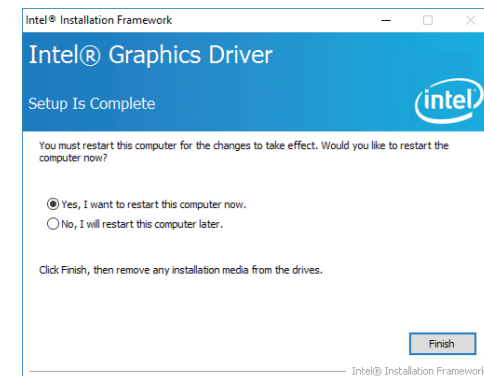

Audio Driver

To install the driver, download “CS100 Audio Driver” zip file at our website.

1. Setup is ready to install the driver. Click “Next”.

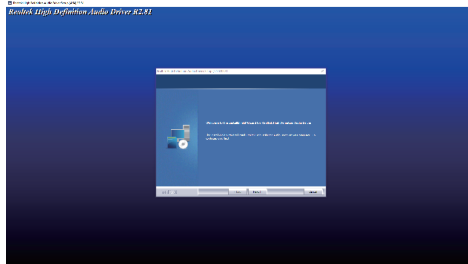

2. Click “Yes, I want to restart my computer now” then click “Finish”.

Restarting the system will allow the new software installation to take effect.

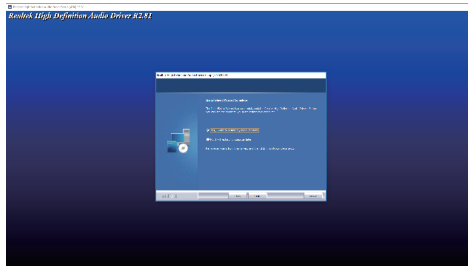

Intel LAN Driver

To install the driver, download “CS100 LAN Driver” zip file at our website.

1. Setup is ready to install the driver. Click “Next”.

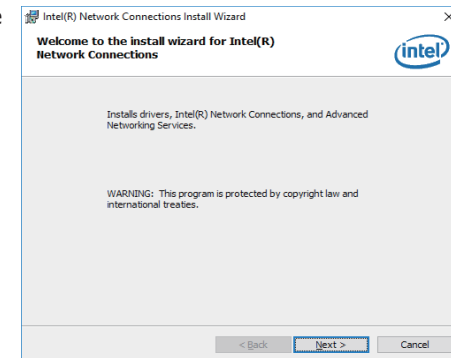

2. Click “I accept the terms in the license agreement” then click “Next”.

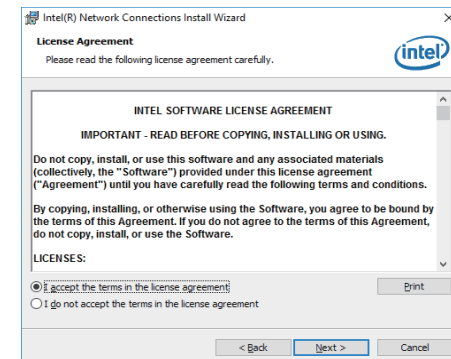

3. Select the program features you want installed then click “Next”.

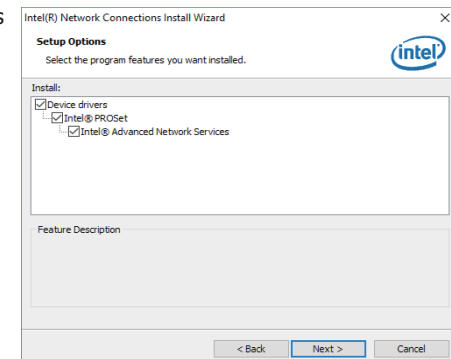

4. Click "Install" to begin the installation.

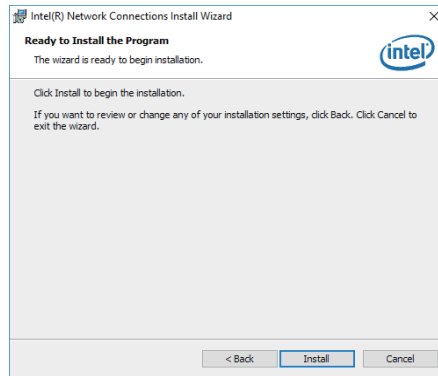

5. The step displays the installing status in the progress.

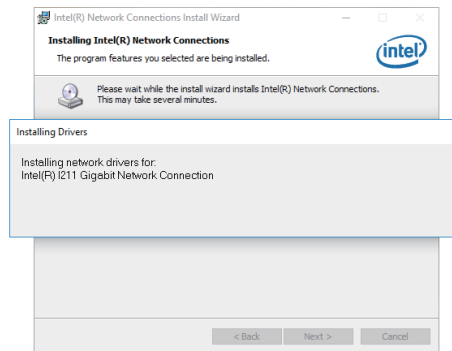

6. After completing installation, click "Finish".

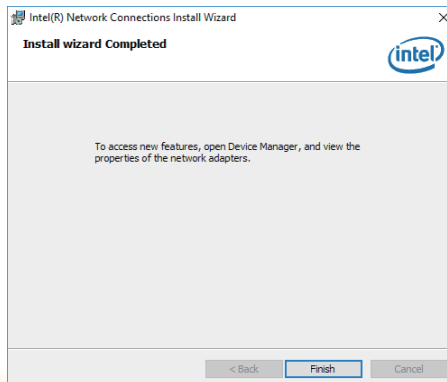

Intel Management Engine Interface Drivers

To install the driver, download "CS100 MEI Driver" zip file at our website.

1. Setup is ready to install the driver. Click "Next".

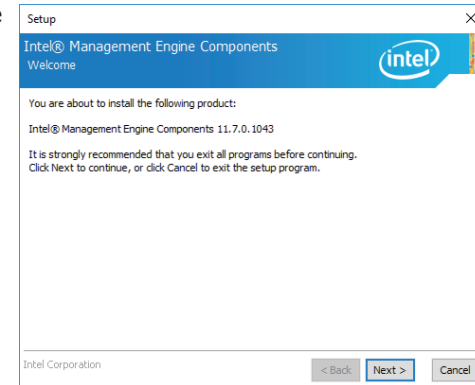

2. Read the license agreement then tick "I accept the terms in the License Agreement". Click "Next".

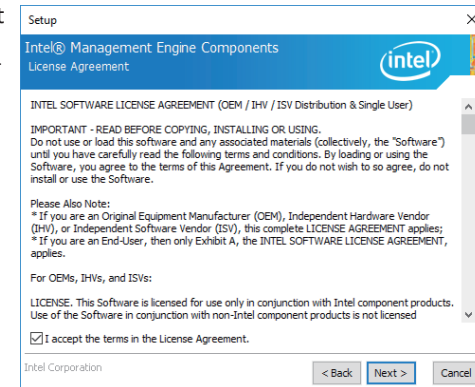

- Click "Next" to install to the default folder, or click "Change" to choose another destination folder.

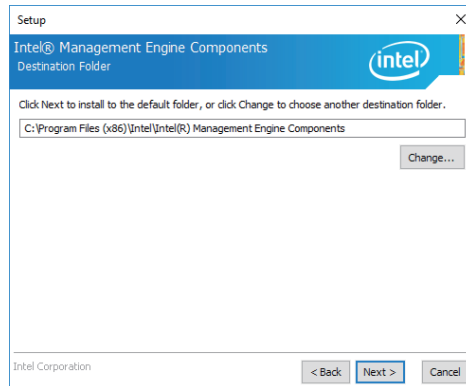

- Please wait while the product is being installed.

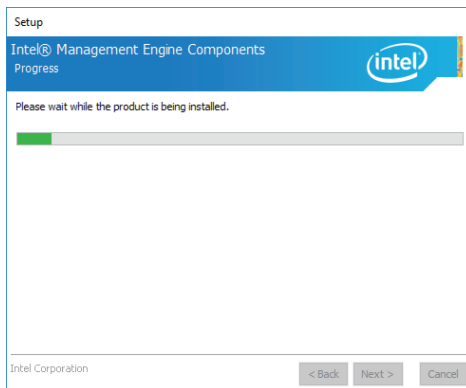

- After completing installation, click "Finish".

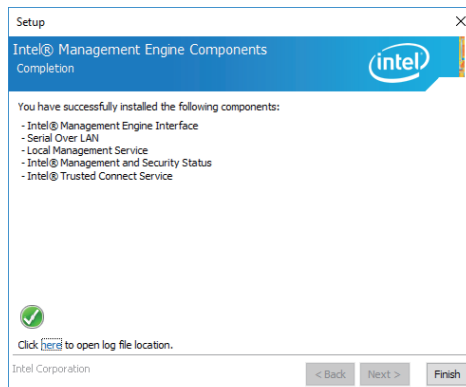

SIO Driver

To install the driver, download "CS100 SIO Driver" zip file at our website.

- Setup is ready to install the driver. Click "Next".

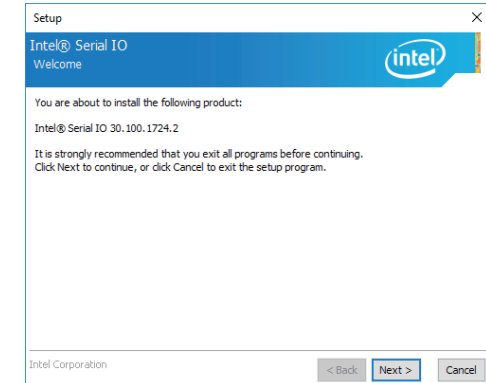

- Read the license agreement carefully. Tick "I accept the terms in the License Agreement" then click "Next".

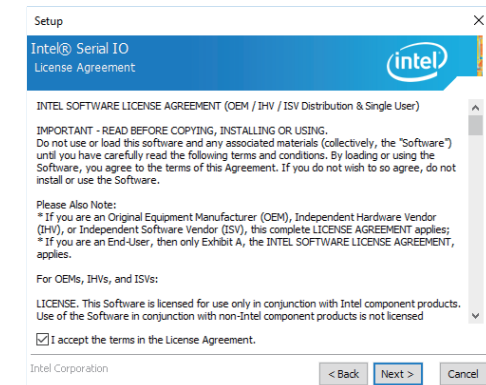

3. Go through the readme document for system requirements and installation tips then click "Next".

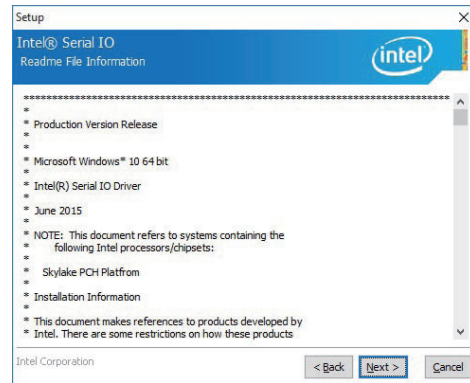

4. Setup is ready to install the driver. Click "Next".



5. Setup is now installing the driver.

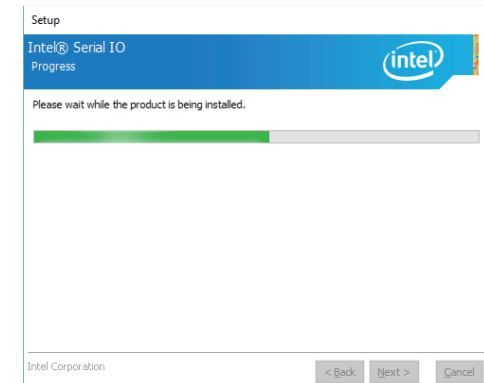

6. Click "Yes, I want to restart this computer now" then click "Finish".

Restarting the system will allow the new software installation to take effect.

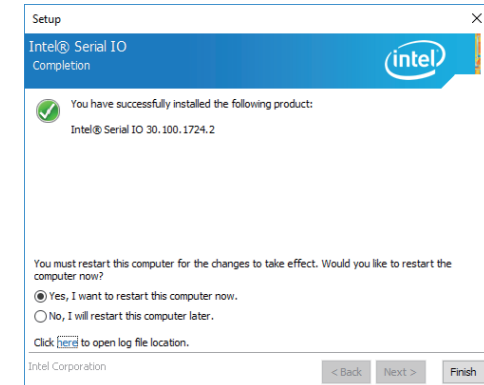

Intel Rapid Storage Technology

The Intel Rapid Storage Technology is a utility that allows you to monitor the current status of the SATA drives. It enables enhanced performance and power management for the storage subsystem.

To install the driver, download "CS100 IRST Driver" zip file at our website.

1. Setup is ready to install the utility. Click "Next".

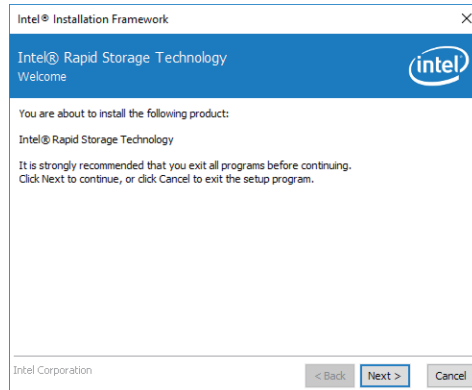

2. Read the license agreement and click "I accept the terms in the License Agreement". Then, click "Next".

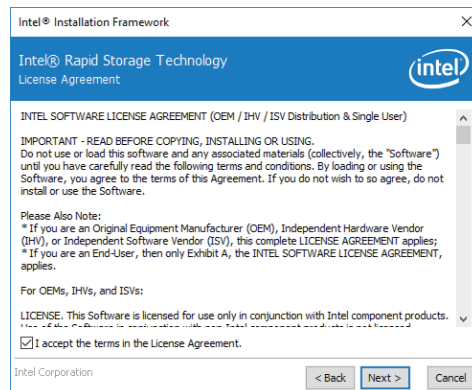

3. Go through the readme document to view system requirements and installation information then click "Next".

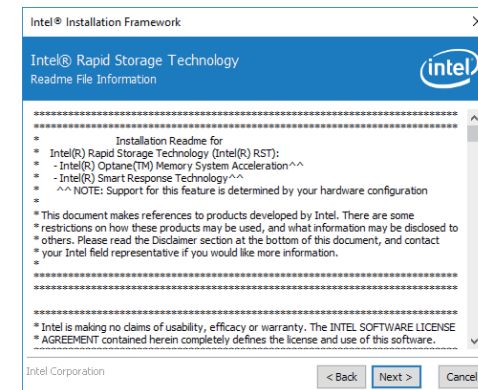

4. Click "Next" to install to the default folder or click "Change to choose another destination folder".

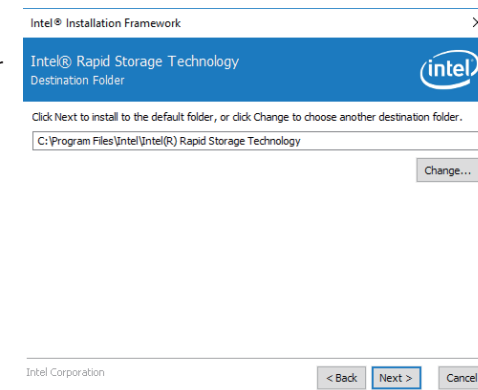

5. Confirm the installation and click "Next".

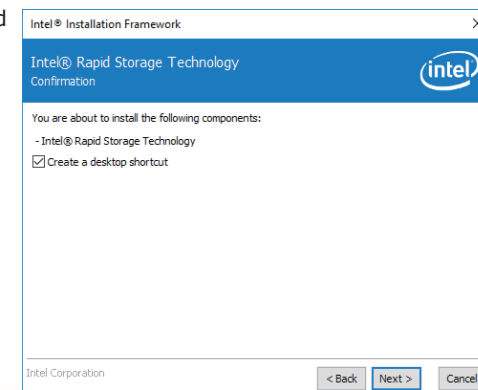

6. Click “Yes, I want to restart this computer now” to complete the installation and then click “Finish”.

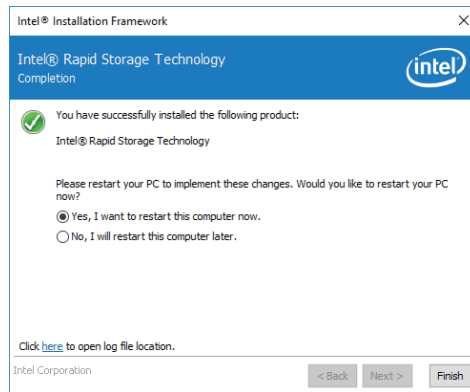

Chapter 5 - RAID (CS100-Q370/C246 Only)

The system board allows configuring RAID on Serial ATA drives. It supports RAID 0, RAID 1, and RAID 5.

RAID Levels

RAID 0 (Striped Disk Array without Fault Tolerance)

RAID 0 uses two new identical hard disk drives to read and write data in parallel, interleaved stacks. Data is divided into stripes and each stripe is written alternately between two disk drives. This improves the I/O performance of the drives at different channel; however it is not fault tolerant. A failed disk will result in data loss in the disk array.

RAID 1 (Mirroring Disk Array with Fault Tolerance)

RAID 1 copies and maintains an identical image of the data from one drive to the other drive. If a drive fails to function, the disk array management software directs all applications to the other drive since it contains a complete copy of the drive's data. This enhances data protection and increases fault tolerance to the entire system. Use two new drives or an existing drive and a new drive but the size of the new drive must be the same or larger than the existing drive.

RAID 5

RAID 5 stripes data and parity information across hard drives. It is fault tolerant and provides better hard drive performance and more storage capacity.

RAID Level	Min. Drives	Protection	Description
RAID 0	2	None	Data striping without redundancy
RAID 1	2	Single Drive Failure	Disk mirroring
RAID 5	3	Single Drive Failure	Block-level data striping with distributed parity

Settings

To enable the RAID function, the following settings are required.

1. Connect the Serial ATA drives.
2. Enable RAID in the AMI BIOS.
3. Create a RAID volume.
4. Install the Intel Rapid Storage Technology Utility.

Step 1: Connect the Serial ATA Drives

Refer to chapter 2 for details on connecting the Serial ATA drives.



Important:

1. Make sure you have installed the Serial ATA drives and connected the data cables otherwise you won't be able to enter the RAID BIOS utility.
2. Treat the cables with extreme caution especially while creating RAID. A damaged cable will ruin the entire installation process and operating system. The system will not boot and you will lost all data in the hard drives. Please give special attention to this warning because there is no way of recovering back the data.

Step 2: Enable RAID in the AMI BIOS

1. Power-on the system then press to enter the main menu of the AMI BIOS.
2. Go to "Chipset" menu and select the "PCH-IO Configuration" menu then "SATA And RST Configuration" menu.
3. Change the "SATA Mode Selection" to "Intel RST Premium With Intel Optane System Acceleration" mode.
4. Press F10 to save the changes.
5. Reboot the system.

Step 3: Create a RAID Volume

1. Go to the "Advanced" menu of the AMI BIOS and select "Intel(R) Rapid Storage Technology".

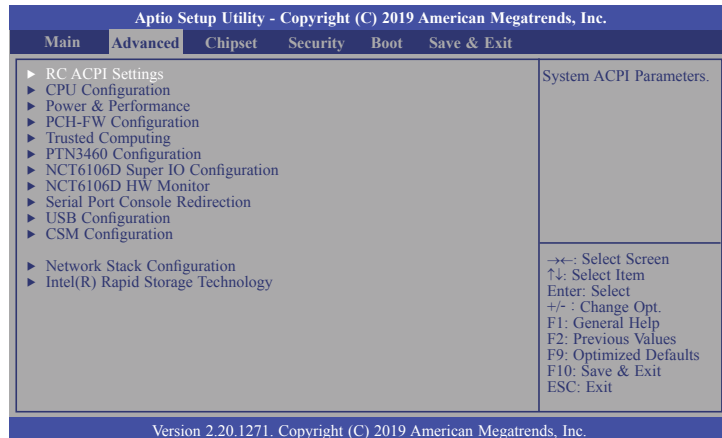

2. The screen displays all available drives. Select "Create RAID volume" to create a RAID volume".
3. Use the up or down arrow keys to select the RAID level and press <Enter>.
4. Use the up or down arrow keys to scroll through the list of hard drives and press <Enter> to select the drive.
5. Press <Enter>.
6. Use the up or down arrow keys to select the strip size and press <Enter>.
7. Enter the volume size and press <Enter>.
8. At the prompt, press <Y> to confirm volume creation.

Step 4: Install the Intel Rapid Storage Technology Utility

The Intel Rapid Storage Technology Utility can be installed from within Windows. It allows RAID volume management (create, delete, migrate) from within the operating system. It will also display useful SATA device and RAID volume information. The user interface, tray icon service and monitor service allow you to monitor the current status of the RAID volume and/or SATA drives. It enables enhanced performance and power management for the storage subsystem.

Please refer to the chapter 4 to install the IRST driver.

Chapter 6 - Intel AMT Settings (CS100-Q370/C246 only)

Overview

Intel Active Management Technology (Intel® AMT) combines hardware and software solution to provide maximum system defense and protection to networked systems.

The hardware and software information are stored in non-volatile memory. With its built-in manageability and latest security applications, Intel® AMT provides the following functions.

- **Discover**

Allows remote access and management of networked systems even while PCs are powered off; significantly reducing desk-side visits.

- **Repair**

Remotely repair systems after OS failures. Alerting and event logging help detect problems quickly to reduce downtime.

- **Protect**

Intel AMT's System Defense capability remotely updates all systems with the latest security software. It protects the network from threats at the source by proactively blocking incoming threats, reactively containing infected clients before they impact the network, and proactively alerting when critical software agents are removed.

Enable Intel® AMT in the AMI BIOS

1. Power-on the system then press to enter the main menu of the AMI BIOS.
2. In the **Advanced** menu, select **PCH-FW Configuration**.

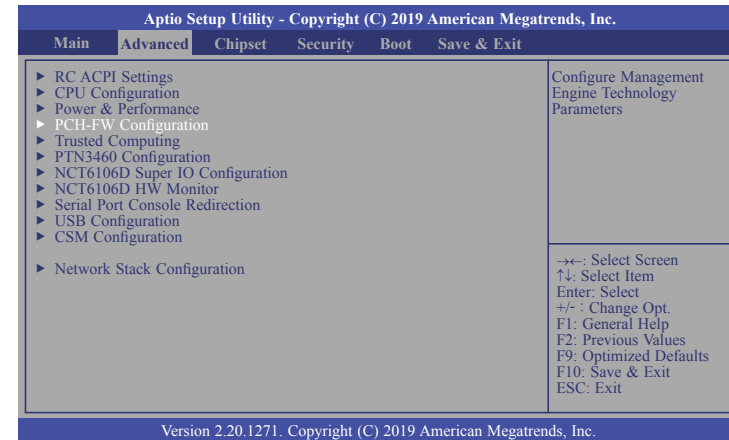

3. Select **Enabled** in the **AMT BIOS Features** field.

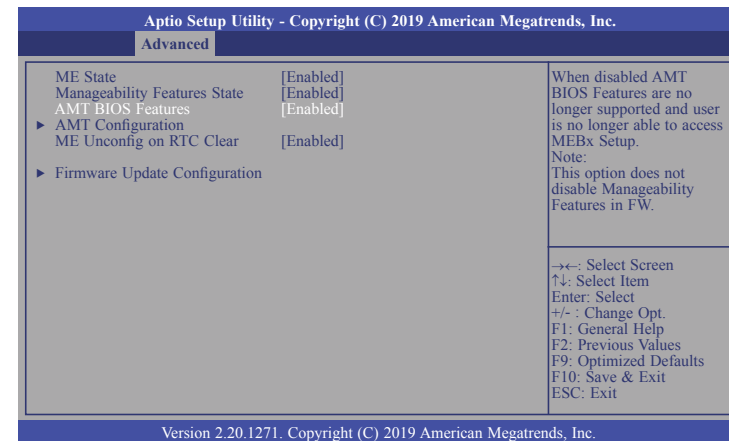

4. In the **Save & Exit** menu, select **Save Changes and Reset** and then press <Enter>. A dialog box will appear. Select **Yes** and press Enter to reset the system after saving all changes made.

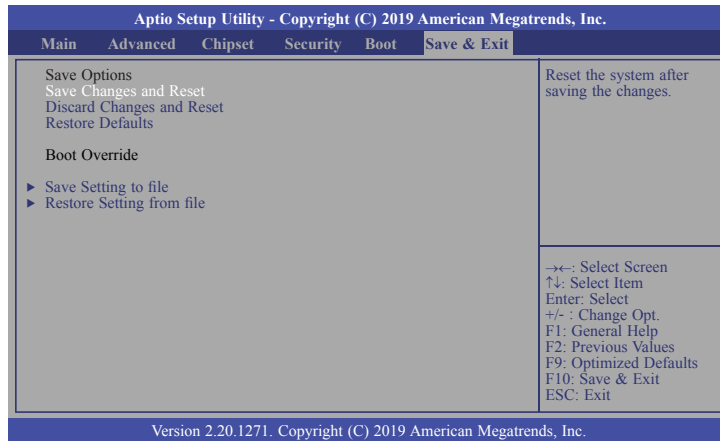

Configure Intel® AMT in the Intel® Management Engine BIOS Extension (MEBX) Setup Menu

1. When the system reboots, the following message will be displayed. Press <Ctrl + P> as soon as the message is displayed; as this message will be displayed for only a few seconds.



2. Select **MEBx Login** and press Enter. You will be prompted for a password. The default password is "admin". Enter the default password in the space provided under Intel(R) ME Password then press Enter.

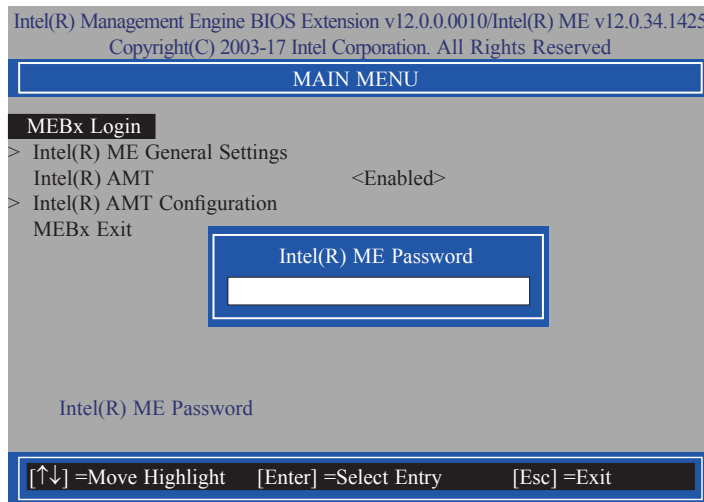

3. Enter a new password in the space provided under Intel(R) ME New Password then press Enter. The password must include:

- 8-32 characters
- Strong 7-bit ASCII characters excluding : , and " characters
- At least one digit character (0, 1, ...9)
- At least one 7-bit ASCII non alpha-numeric character, above 0x20, (e.g. !, \$, ;)
- Both lower case and upper case characters

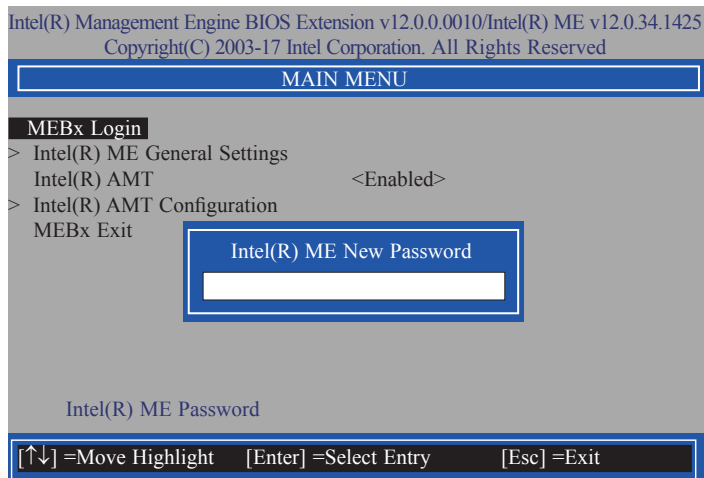

4. You will be asked to verify the new password. Enter the same new password in the space provided under Verify Password then press Enter.

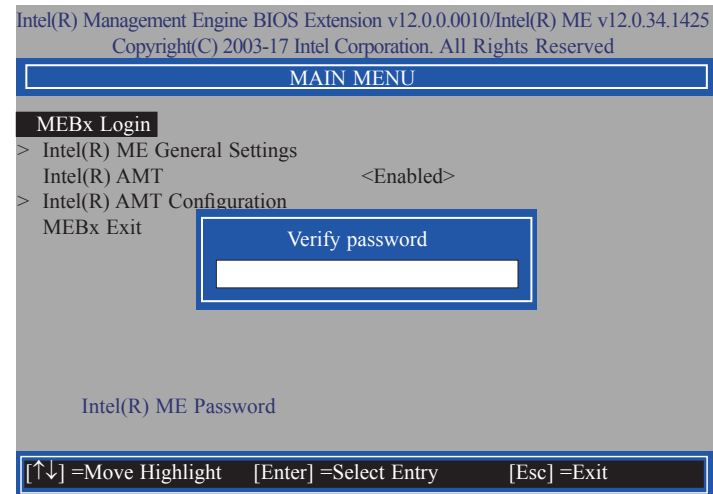

5. Select **Intel(R) ME General Settings** then press Enter.

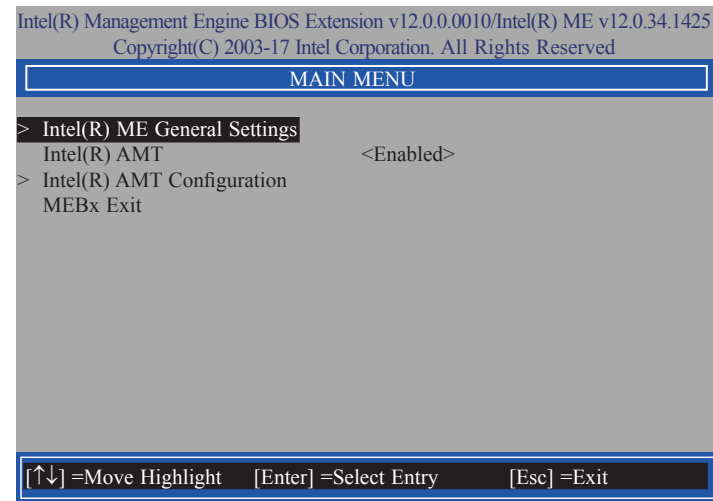

- If you want to change ME password, select **Change ME Password** then press Enter. Enter the current password in the space provided under Intel(R) ME Password then press Enter.



- Enter a new password in the space provided under Intel(R) ME New Password then press Enter. The password must include:
 - 8-32 characters
 - Strong 7-bit ASCII characters excluding : , and " characters
 - At least one digit character (0, 1, ...9)
 - At least one 7-bit ASCII non alpha-numeric character, above 0x20, (e.g. !, \$, ;)
 - Both lower case and upper case characters

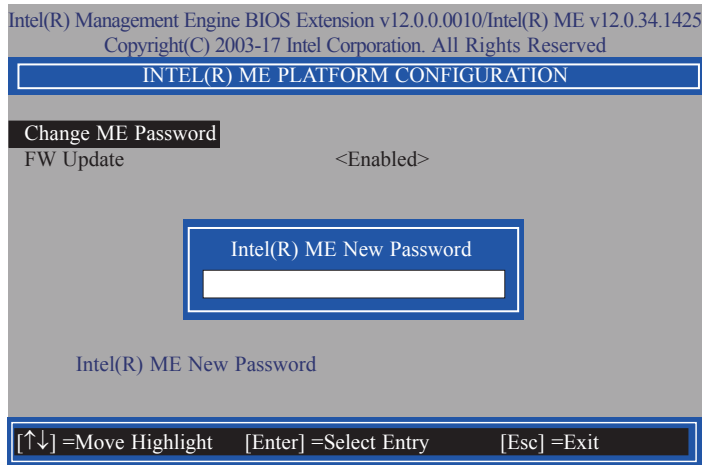

- You will be asked to verify the new password. Enter the same new password in the space provided under Verify Password then press Enter.



- Select **FW Update** then press Enter. Select **Enabled** or **Disabled** or **Password Protected** then press Enter.

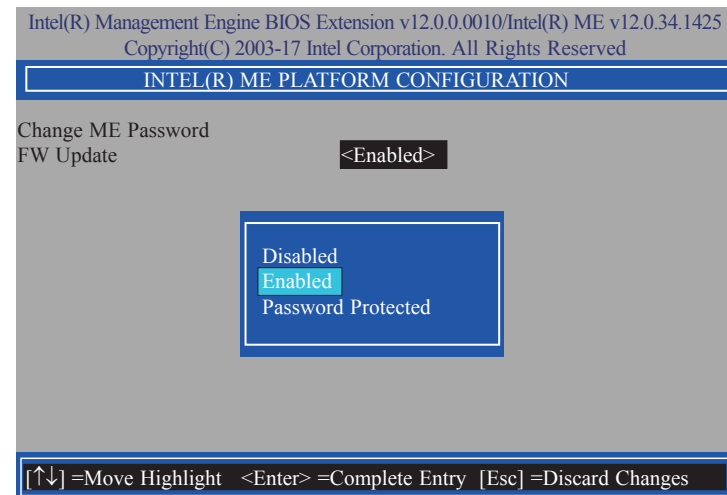

10. Press Esc until you return to the **Main Menu**. Select **Intel(R) AMT** then press Enter. Select **Enabled** or **Disabled** then press Enter.

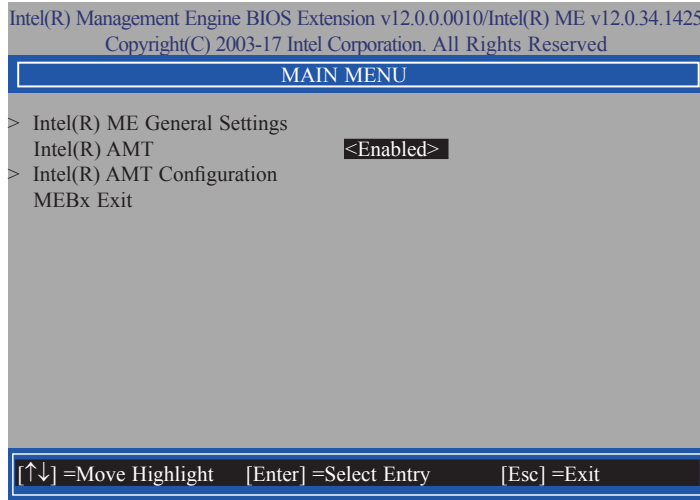

11. Select **Intel(R) AMT Configuration** then press Enter.

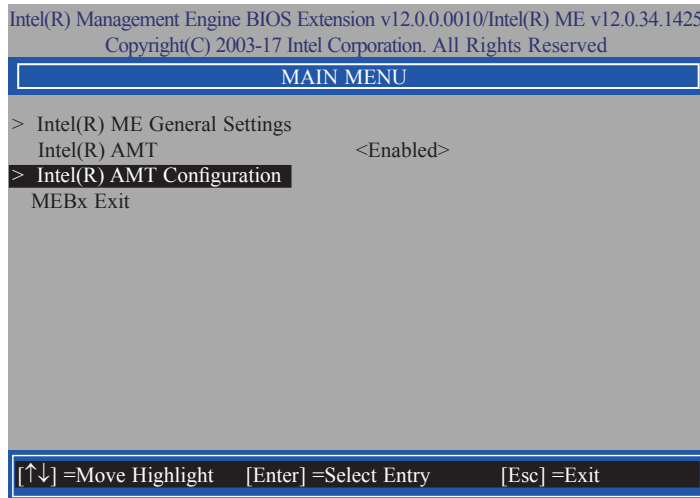

12. In the **Intel(R) AMT Configuration** menu, select **Manageability Feature Selection** then press Enter. Select **Enabled** or **Disabled** then press Enter.

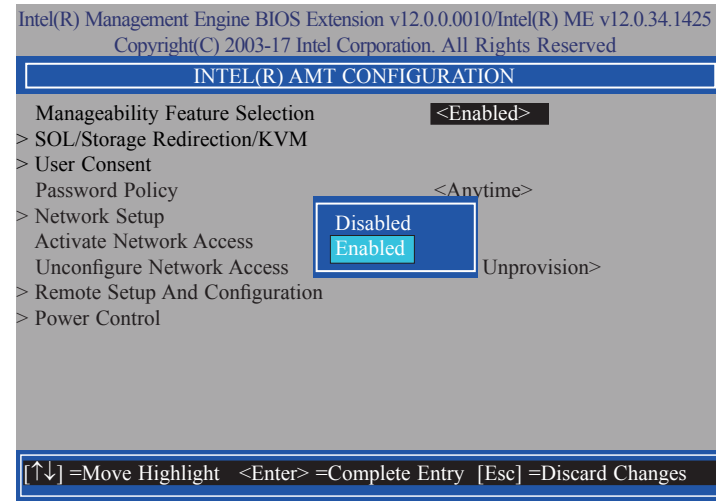

13. In the **Intel(R) AMT Configuration** menu, select **SOL/Storage Redirection/KVM** then press Enter.

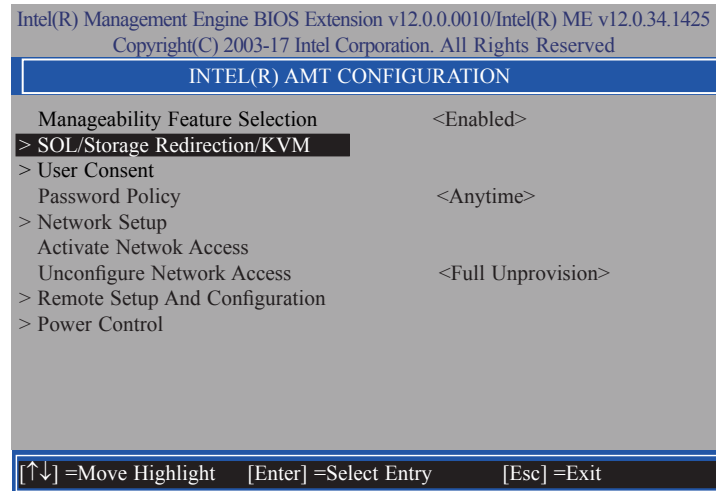

14. Select **SOL** then press Enter. Select **Enabled** or **Disabled** then press Enter.

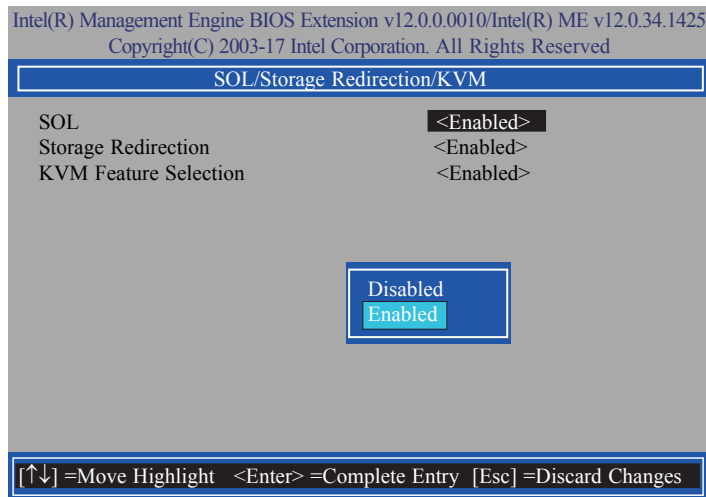

16. Select **KVM Feature Selection** then press Enter. Select **Enabled** or **Disabled** then press Enter.

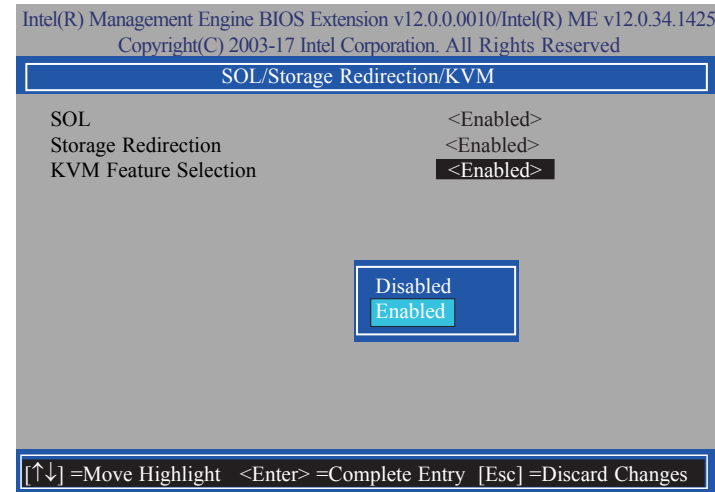

15. Select **Storage Redirection** then press Enter. Select **Enabled** or **Disabled** then press Enter.

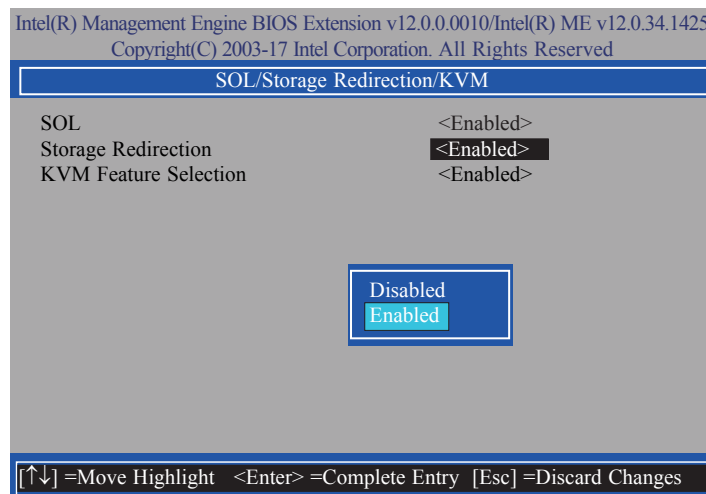

17. Press Esc until you return to the **Intel(R) AMT Configuration** menu. Select **User Consent** then press Enter.

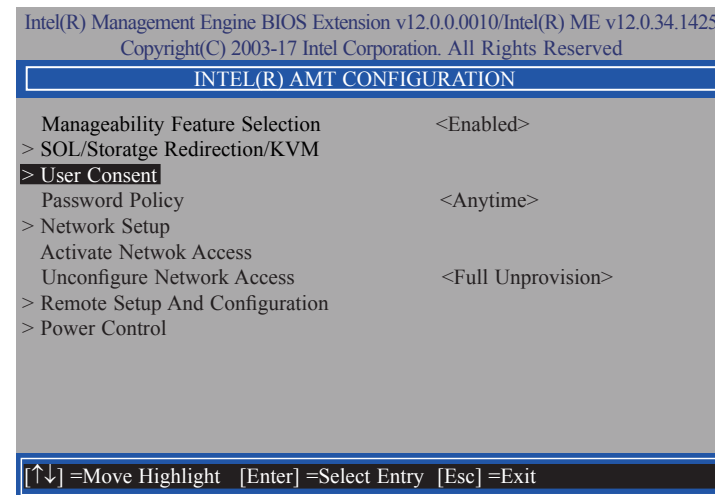

18. In the **User Consent** menu, select **User Opt-in** then press Enter. Select **NONE** or **KVM** or **ALL** then press Enter.

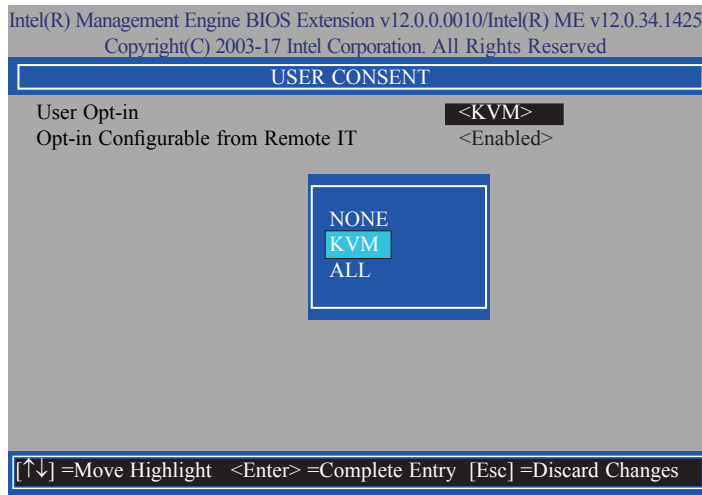

19. Select **Opt-in Configurable from Remote IT** then press Enter. Select **Enabled** or **Disabled** then press Enter.

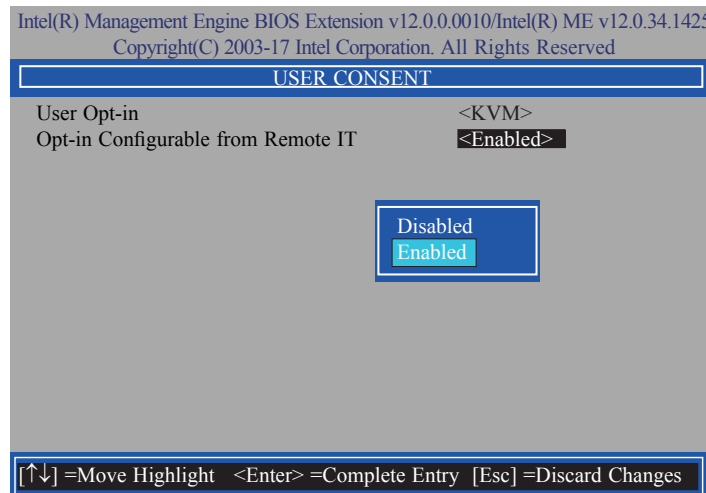

20. Press Esc until you return to the **Intel(R) AMT Configuration** menu. Select **Password Policy** then press Enter.

You may choose to use a password only during setup and configuration or to use a password anytime the system is being accessed.

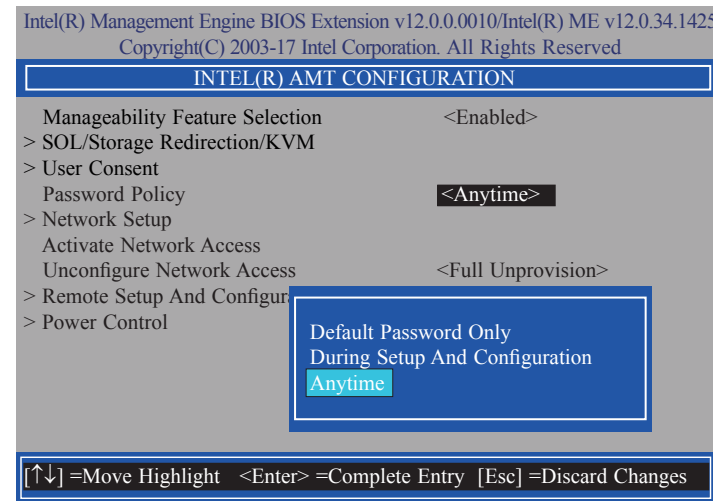

21. In the **Intel(R) AMT Configuration** menu, select **Network Setup** then press Enter.

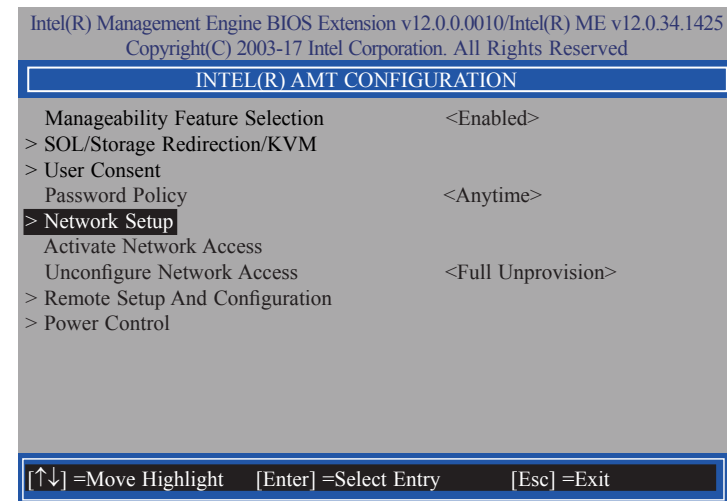

22. In the **Intel(R) ME Network Setup** menu, select **Intel(R) ME Network Name Settings** then press Enter.

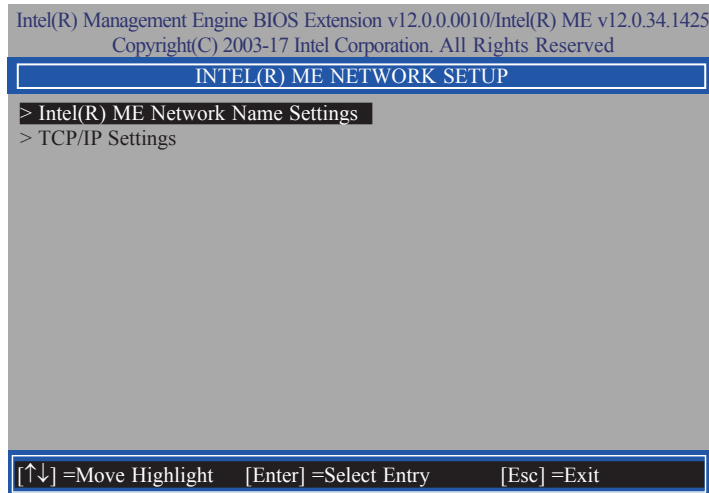

23. In the **Intel(R) ME Network Name Settings** menu, select **Host Name** then press Enter. Enter the computer's host name then press Enter.

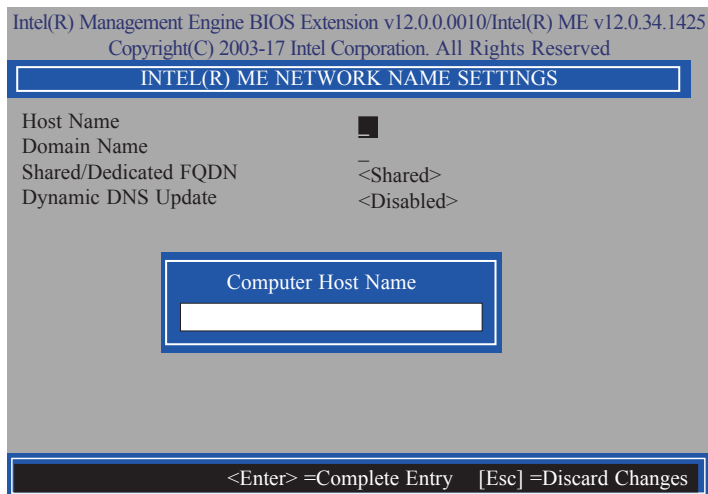

24. Select **Domain Name** then press Enter. Enter the computer's domain name then press Enter.

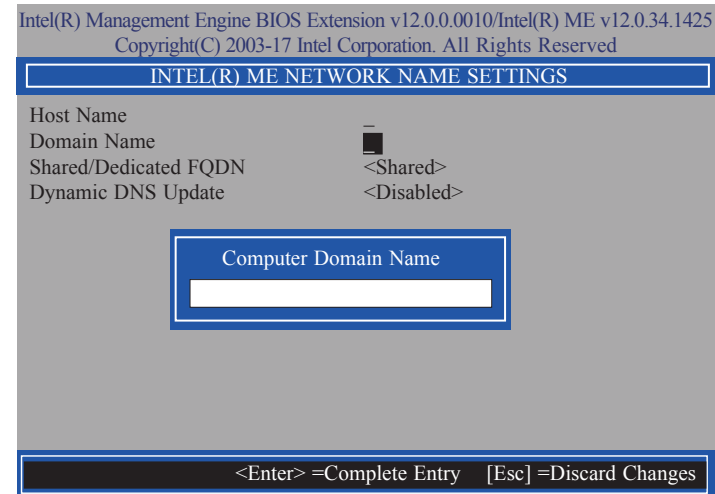

25. Select **Shared/Dedicated FQDN** then press Enter. Select **Shared** or **Dedicated** then press Enter.

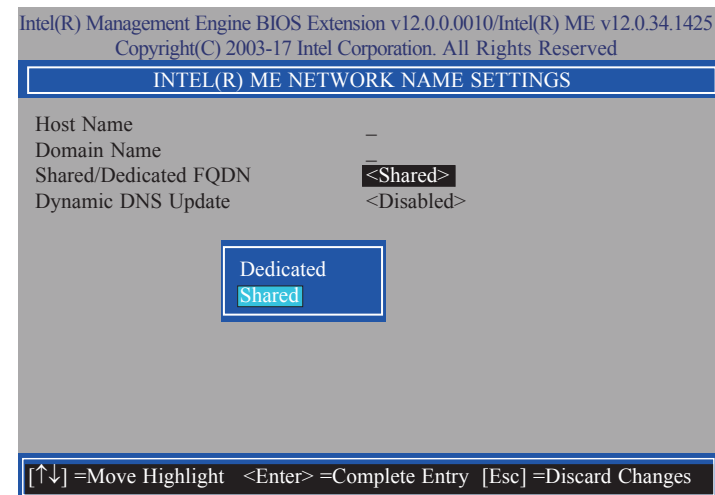

26. Select **Dynamic DNS Update** then press Enter. Select **Enabled** or **Disabled** then press Enter. If **Dynamic DNS Update** is set to **Enabled**, **Periodic Update Interval** and **TTL** fields will show up.

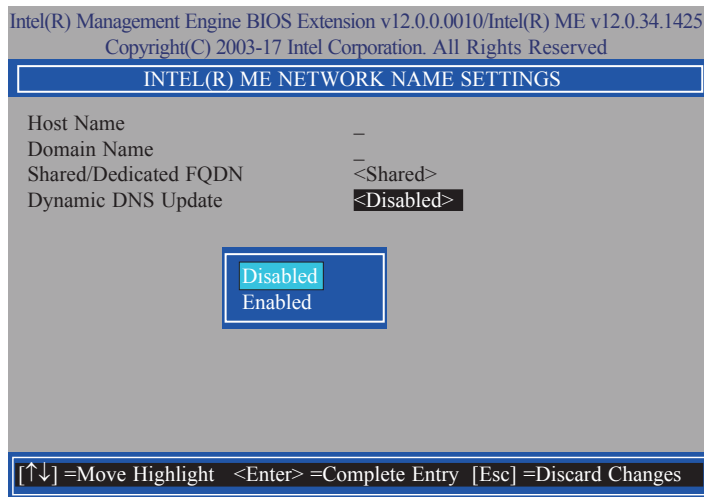

28. Select **TTL** then press Enter. Enter value then press Enter.

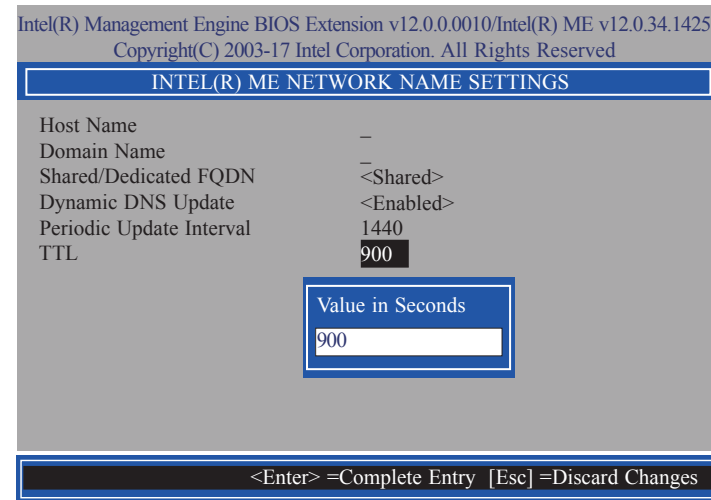

27. Select **Periodic Update Interval** then press Enter. Enter value then press Enter.

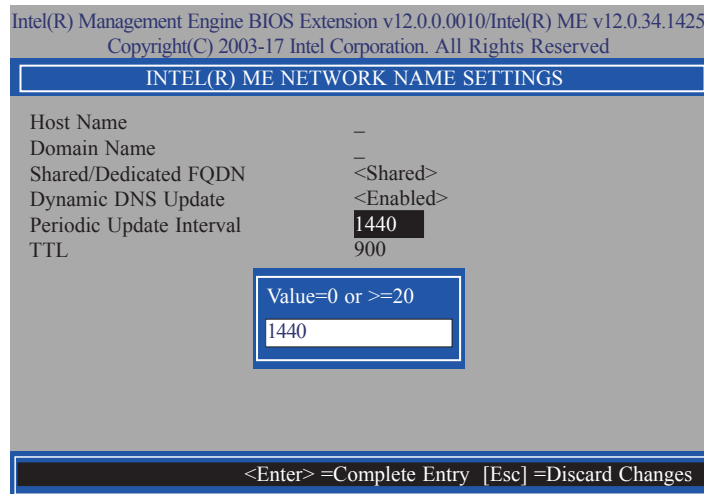

29. Press Esc until you return to the **Intel(R) ME Network Setup** menu. Select **TCP/IP Settings** then press Enter. In the **TCP/IP Settings** menu, select **Wired LAN IPV4 Configuration** then press Enter.

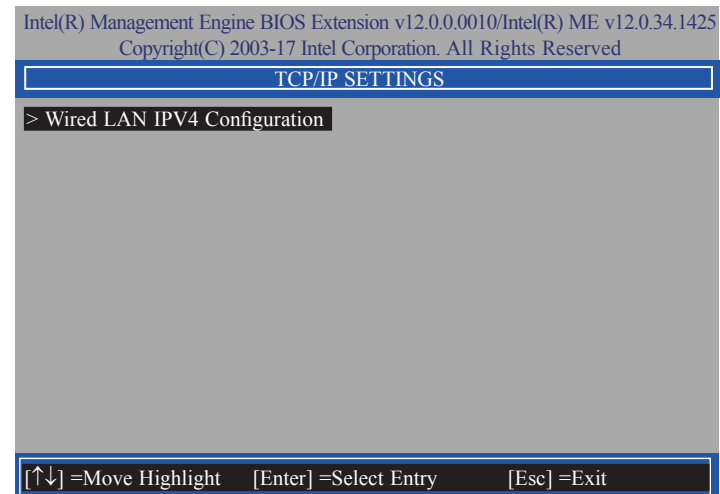

30. In the **Wired LAN IPv4 Configuration** menu, select **DHCP Mode** then press Enter. Select **Enabled** or **Disabled** then press Enter. If set to **Disabled**, **IPV4 Address**, **Subnet Mask Address**, **Default Gateway Address**, **Preferred DNS Address** and **Alternate DNS Address** will show up.

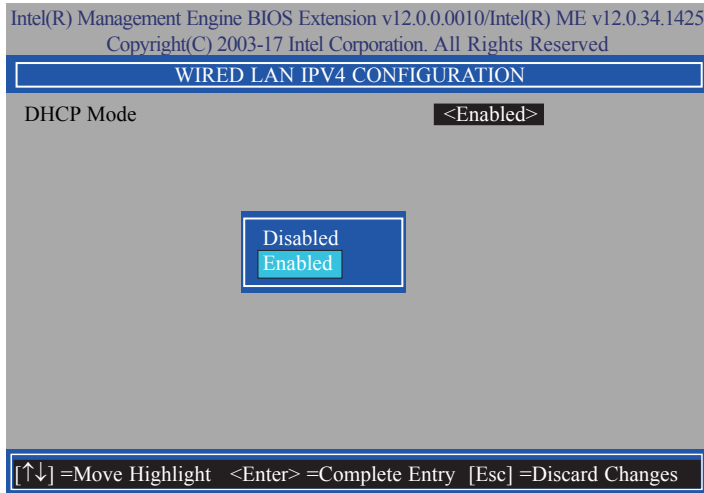

31. Select **IPV4 Address** then press Enter. Enter address then press Enter.

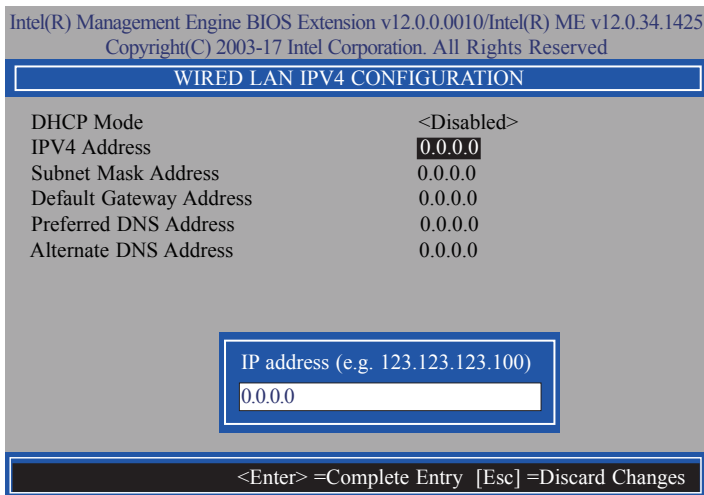

32. Select **Subnet Mask Address** then press Enter. Enter address then press Enter.

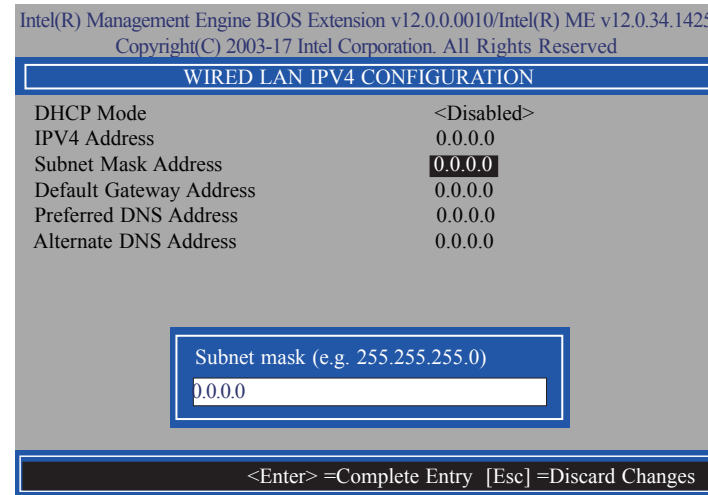

33. Select **Default Gateway Address** then press Enter. Enter address then press Enter.

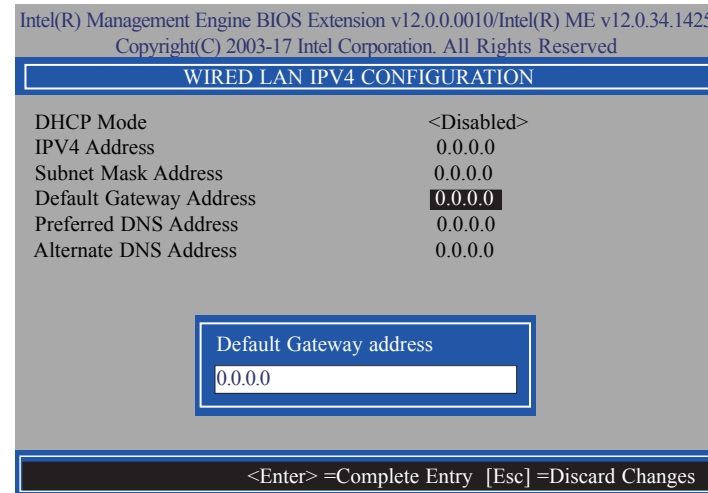

34. Select **Preferred DNS Address** then press Enter. Enter address then press Enter.

Intel(R) Management Engine BIOS Extension v12.0.0.0010/Intel(R) ME v12.0.34.1425
Copyright(C) 2003-17 Intel Corporation. All Rights Reserved

WIRED LAN IPV4 CONFIGURATION

DHCP Mode	<Disabled>
IPV4 Address	0.0.0.0
Subnet Mask Address	0.0.0.0
Default Gateway Address	0.0.0.0
Preferred DNS Address	0.0.0.0
Alternate DNS Address	0.0.0.0

Preferred DNS address
0.0.0.0

<Enter> =Complete Entry [Esc] =Discard Changes

35. Select **Alternate DNS Address** then press Enter. Enter address then press Enter.

Intel(R) Management Engine BIOS Extension v12.0.0.0010/Intel(R) ME v12.0.34.1425
Copyright(C) 2003-17 Intel Corporation. All Rights Reserved

WIRED LAN IPV4 CONFIGURATION

DHCP Mode	<Disabled>
IPV4 Address	0.0.0.0
Subnet Mask Address	0.0.0.0
Default Gateway Address	0.0.0.0
Preferred DNS Address	0.0.0.0
Alternate DNS Address	0.0.0.0

Alternate DNS address
0.0.0.0

<Enter> =Complete Entry [Esc] =Discard Changes

36. Press Esc until you return to the **Intel(R) AMT Configuration** menu. If you want to activate the current network settings and open the ME network interface, select **Activate Network Access**, press Enter, then press Y.

Intel(R) Management Engine BIOS Extension v12.0.0.0010/Intel(R) ME v12.0.34.1425
Copyright(C) 2003-17 Intel Corporation. All Rights Reserved

INTEL(R) AMT CONFIGURATION

Manageability Feature Selection	<Enabled>
> SOL/Storage Redirection/KVM	
> User Consent	
Password Policy	<Anytime>
> Network Setup	
Activate Network Access	
Unconfigure Network Access	<Full Unprovision>
> Remote Setup And Configuration	
> Power Control	

Activates the current network settings and opens the ME network interface
Continue: (Y/N)

[↑↓] =Move Highlight [Enter] =Select Entry [Esc] =Exit

37. In the **Intel(R) AMT Configuration** menu, select **Unconfigure Network Access** then press Enter.

Intel(R) Management Engine BIOS Extension v12.0.0.0010/Intel(R) ME v12.0.34.1425
Copyright(C) 2003-17 Intel Corporation. All Rights Reserved

INTEL(R) AMT CONFIGURATION

Manageability Feature Selection	<Enabled>
> SOL/Storage Redirection/KVM	
> User Consent	
Password Policy	<Anytime>
> Network Setup	
Activate Network Access	
Unconfigure Network Access	<Full Unprovision>
> Remote Setup And Configuration	
> Power Control	

Full Unprovision

[↑↓] =Move Highlight <Enter> =Complete Entry [Esc] =Discard Changes

38. In the **Intel(R) AMT Configuration** menu, select **Remote Setup And Configuration** then press Enter.

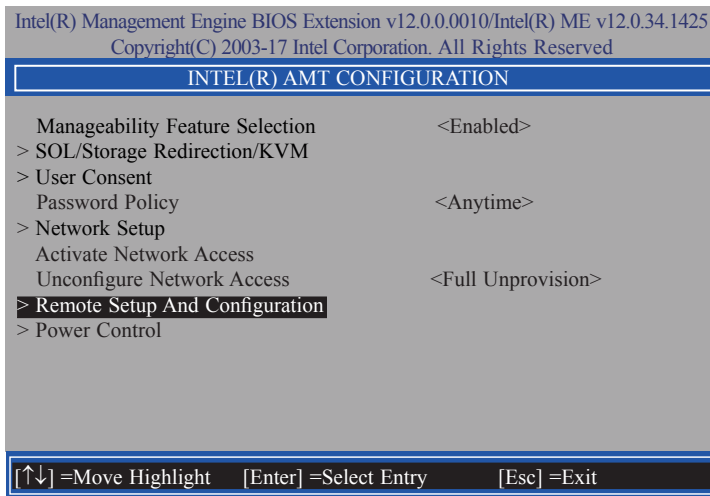

39. In the **Intel(R) Remote Setup And Configuration** menu, select **Current Provisioning Mode** then press Enter.

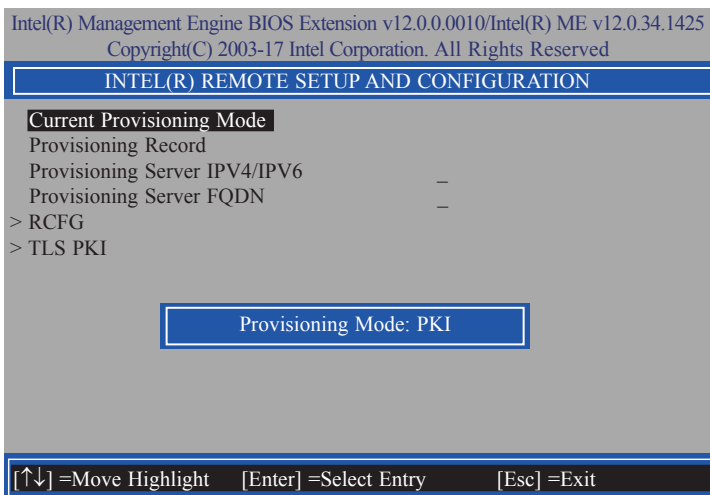

40. In the **Intel(R) Remote Setup And Configuration** menu, select **Provisioning Record** then press Enter.

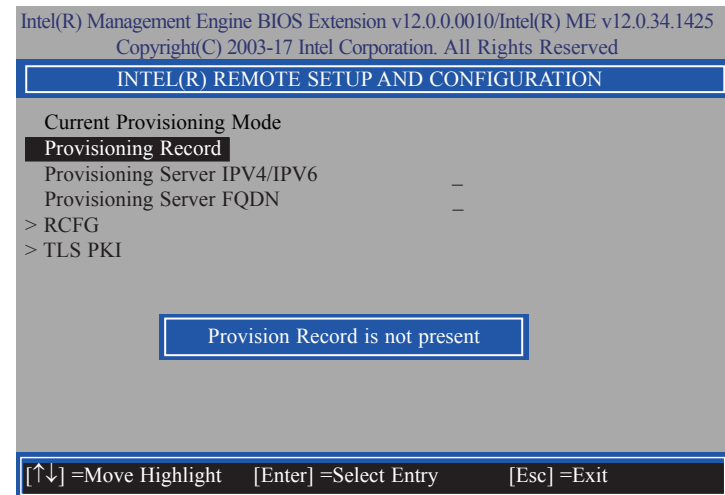

41. In the **Intel(R) Remote Setup And Configuration** menu, select **Provisioning Server IPV4/IPV6** then press Enter. Enter the address then press Enter.

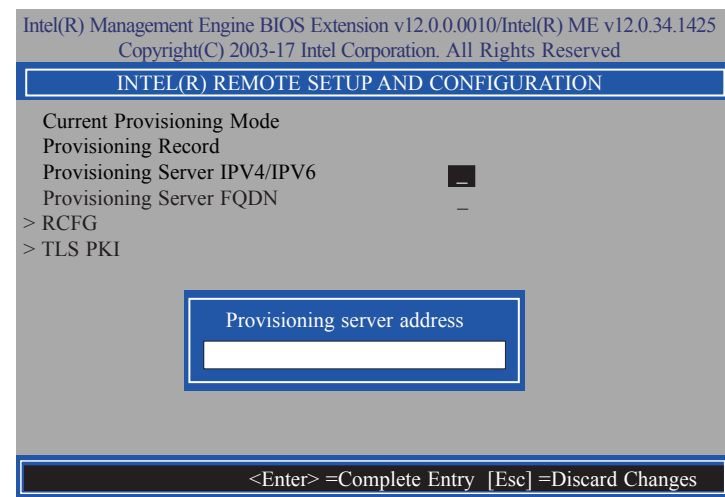

42. In the **Intel(R) Remote Setup And Configuration** menu, select **Provisioning Server FQDN** then press Enter. Enter the FQDN then press Enter.

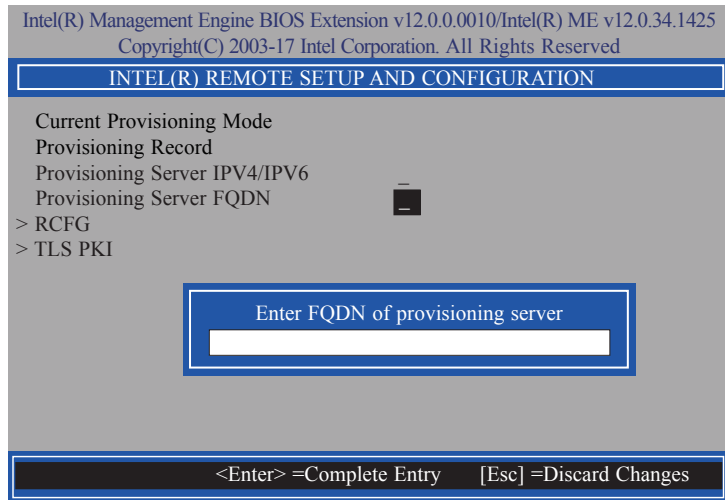

43. If you want to activate remote configuration, in the **Intel(R) Remote Setup And Configuration** menu, select **RCFG** then press Enter. Select **Start Configuration** then press Enter. Press Y to activate.

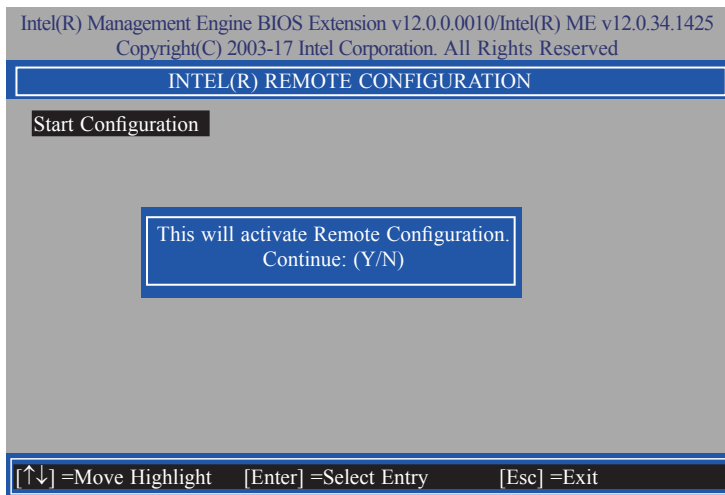

44. Press Esc until you return to the **Intel(R) Remote Setup And Configuration** menu. Select **TLS PKI** then press Enter. Select **Remote Configuration **** then press Enter. Select **Enabled** or **Disabled** then press Enter.

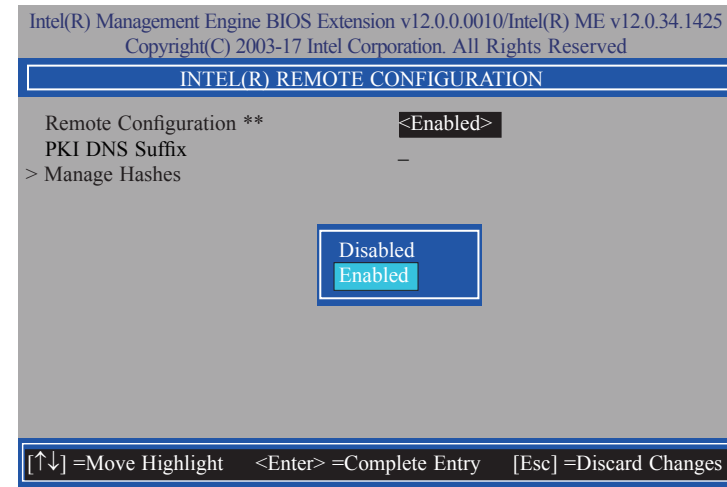

45. Select **PKI DNS Suffix** then press Enter. Enter the PKI DNS Suffix then press Enter.

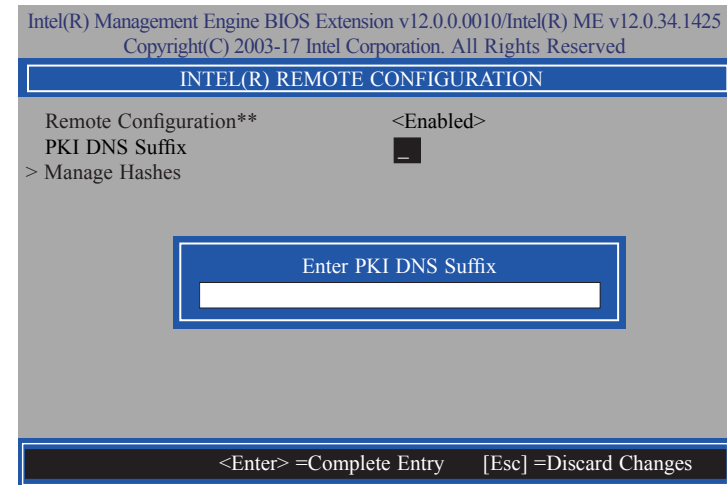

46. In the **Intel(R) Remote Configuration** menu, select **Manage Hashes** then press Enter. Select the hash name then press Insert to enter custom hash certificate name, press Delete to delete hash, press Enter to view hash information, press + to activate or deactivate hash, and press Esc to exit.

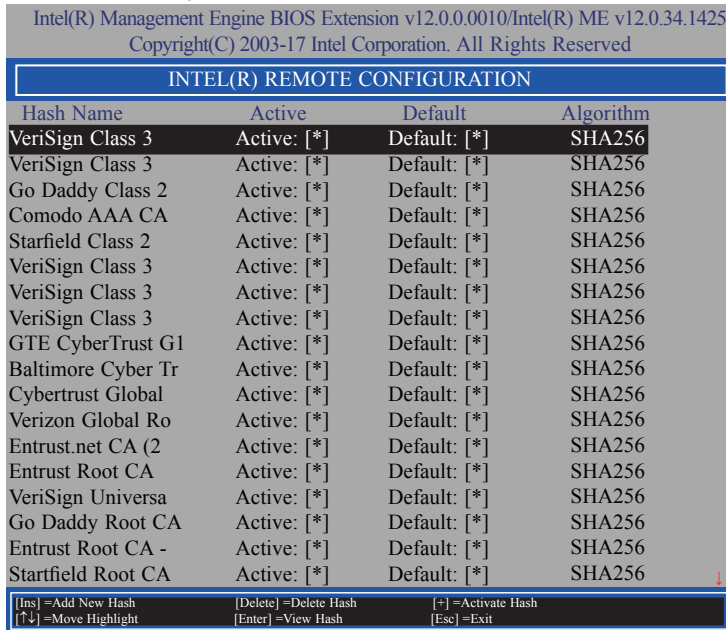

47. Press Esc until you return to the **Intel(R) AMT Configuration** menu, select **Power Control** then press Enter. In the **Intel(R) AMT Power Control** menu, select **Intel(R) AMT ON in Host Sleep States** then press Enter. Select an option then press Enter.

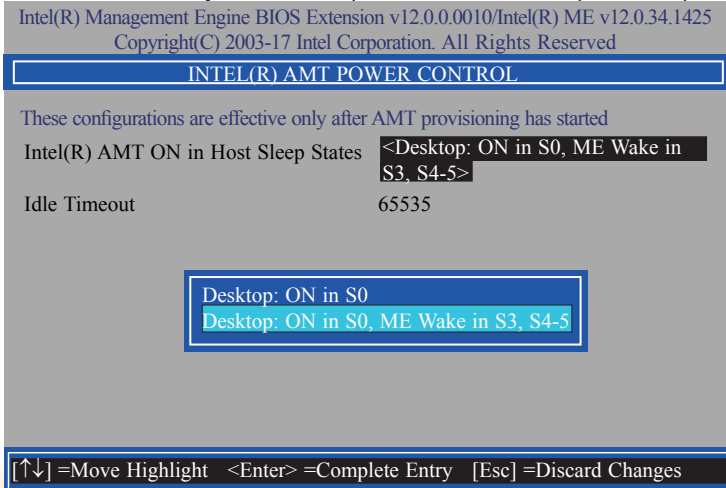

48. In the **Intel(R) AMT Power Control** menu, select **Idle Timeout** then press Enter. Enter the timeout value and press Enter.

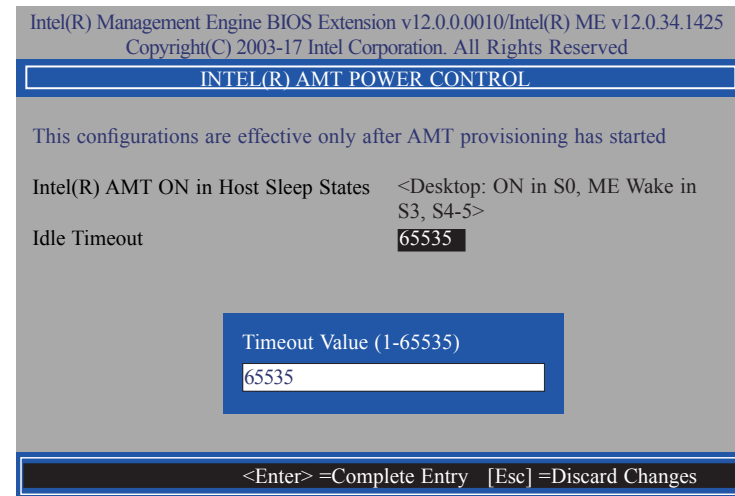

49. Press Esc until you return to the **Main Menu**. Select **MEBx Exit** then press Enter. Press Y to exit.

