



BT101/103

Mini-ITX Industrial Motherboard

User's Manual

Copyright

This publication contains information that is protected by copyright. No part of it may be reproduced in any form or by any means or used to make any transformation/adaptation without the prior written permission from the copyright holders.

This publication is provided for informational purposes only. The manufacturer makes no representations or warranties with respect to the contents or use of this manual and specifically disclaims any express or implied warranties of merchantability or fitness for any particular purpose. The user will assume the entire risk of the use or the results of the use of this document. Further, the manufacturer reserves the right to revise this publication and make changes to its contents at any time, without obligation to notify any person or entity of such revisions or changes.

Changes after the publication's first release will be based on the product's revision. The website will always provide the most updated information.

© 2015. All Rights Reserved.

Trademarks

Product names or trademarks appearing in this manual are for identification purpose only and are the properties of the respective owners.

FCC and DOC Statement on Class B

This equipment has been tested and found to comply with the limits for a Class B digital device, pursuant to Part 15 of the FCC rules. These limits are designed to provide reasonable protection against harmful interference when the equipment is operated in a residential installation. This equipment generates, uses and can radiate radio frequency energy and, if not installed and used in accordance with the instruction manual, may cause harmful interference to radio communications. However, there is no guarantee that interference will not occur in a particular installation. If this equipment does cause harmful interference to radio or television reception, which can be determined by turning the equipment off and on, the user is encouraged to try to correct the interference by one or more of the following measures:

- Reorient or relocate the receiving antenna.
- Increase the separation between the equipment and the receiver.
- Connect the equipment into an outlet on a circuit different from that to which the receiver is connected.
- Consult the dealer or an experienced radio TV technician for help.

Notice:

1. The changes or modifications not expressly approved by the party responsible for compliance could void the user's authority to operate the equipment.
2. Shielded interface cables must be used in order to comply with the emission limits.

Table of Contents

Copyright.....	2
Trademarks.....	2
FCC and DOC Statement on Class B.....	2
About this Manual.....	4
Warranty.....	4
Static Electricity Precautions.....	4
Safety Measures.....	4
About the Package.....	5
Chapter 1 - Introduction.....	6
Specifications.....	6
Features.....	7
Chapter 2 - Hardware Installation.....	9
Board Layout.....	9
System Memory.....	9
Installing the DIMM Module.....	10
Installing the Heat Sink.....	11
Jumper Settings.....	12
Clear CMOS Data.....	12
PS/2 Keyboard/Mouse Power Select.....	13
USB Power Select.....	13
LCD/Inverter Power Select.....	14
Panel Power Select.....	14
Backlight Power Select.....	15
Auto Power-on Select.....	15
COM 1 RS232/422/485 Select.....	16
COM 1 RS232/Power Select.....	17
SATA DOM Power Select.....	17
Digital I/O Power Select.....	18
Digital I/O Output State.....	18
Mini PCIe/mSATA Signal Select.....	19
Mini PCIe/mSATA Power Select.....	19
SATA 1/mSATA Signal Select.....	20
Dimming Mode Select.....	20
Rear Panel I/O Ports.....	21
12V DC-in (BT101)/19~24V DC-in (BT103).....	21
Graphics Interface.....	22
RJ45 LAN Ports.....	22

USB Ports.....	23
Audio.....	24
I/O Connectors.....	24
SATA (Serial ATA) Connectors.....	24
SATA (Serial ATA) Power Connectors.....	25
Digital I/O and/or Power Connector.....	25
Cooling Fan Connectors.....	26
Front Panel Connector.....	26
COM (Serial) Ports.....	27
LVDS LCD Panel Connector.....	28
LCD/Inverter Power Connector.....	28
PS/2 Keyboard/Mouse Connector.....	29
SMBus Connector.....	30
Expansion Slots.....	30
S/PDIF Connector.....	31
LAN LED Connector.....	31
Chassis Intrusion Connector.....	32
LPC Connector.....	32
Standby Power LED.....	33
Battery.....	33

Chapter 3 - BIOS Setup.....	34
Overview.....	34
AMI BIOS Setup Utility.....	35
Main.....	35
Advanced.....	35
Chipset.....	45
Security.....	50
Boot.....	50
Save & Exit.....	51
Updating the BIOS.....	51
Notice: BIOS SPI ROM.....	52

Chapter 4 - Supported Software.....	53
-------------------------------------	----

Chapter 5 - Digital I/O Programming Guide.....	66
--	----

Appendix A - Watchdog Sample Code.....	68
--	----

Appendix B - System Error Message.....	69
--	----

Appendix C - Troubleshooting.....	71
-----------------------------------	----

About this Manual

This manual can be downloaded from the website, or acquired as an electronic file included in the optional CD/DVD. The manual is subject to change and update without notice, and may be based on editions that do not resemble your actual products. Please visit our website or contact our sales representatives for the latest editions.

Warranty

1. Warranty does not cover damages or failures that arised from misuse of the product, inability to use the product, unauthorized replacement or alteration of components and product specifications.
2. The warranty is void if the product has been subjected to physical abuse, improper installation, modification, accidents or unauthorized repair of the product.
3. Unless otherwise instructed in this user's manual, the user may not, under any circumstances, attempt to perform service, adjustments or repairs on the product, whether in or out of warranty. It must be returned to the purchase point, factory or authorized service agency for all such work.
4. We will not be liable for any indirect, special, incidental or consequential damages to the product that has been modified or altered.

Static Electricity Precautions

It is quite easy to inadvertently damage your PC, system board, components or devices even before installing them in your system unit. Static electrical discharge can damage computer components without causing any signs of physical damage. You must take extra care in handling them to ensure against electrostatic build-up.

1. To prevent electrostatic build-up, leave the system board in its anti-static bag until you are ready to install it.
2. Wear an antistatic wrist strap.
3. Do all preparation work on a static-free surface.
4. Hold the device only by its edges. Be careful not to touch any of the components, contacts or connections.
5. Avoid touching the pins or contacts on all modules and connectors. Hold modules or connectors by their ends.



Important:

Electrostatic discharge (ESD) can damage your processor, disk drive and other components. Perform the upgrade instruction procedures described at an ESD workstation only. If such a station is not available, you can provide some ESD protection by wearing an antistatic wrist strap and attaching it to a metal part of the system chassis. If a wrist strap is unavailable, establish and maintain contact with the system chassis throughout any procedures requiring ESD protection.

Safety Measures

To avoid damage to the system:

- Use the correct AC input voltage range.

To reduce the risk of electric shock:

- Unplug the power cord before removing the system chassis cover for installation or servicing. After installation or servicing, cover the system chassis before plugging the power cord.

About the Package

The package contains the following items. If any of these items are missing or damaged, please contact your dealer or sales representative for assistance.

- One BT101/BT103 motherboard
- One Serial ATA data with power cable
- One QR (Quick Reference)
- One Heat sink

The board and accessories in the package may not come similar to the information listed above. This may differ in accordance to the sales region or models in which it was sold. For more information about the standard package in your region, please contact your dealer or sales representative.

Optional Items

- USB port cable
- COM port cable
- Serial ATA data with power cable
- Power adapter (100W, 12V)
- Power adapter (120W, 19V)

The board and accessories in the package may not come similar to the information listed above. This may differ in accordance to the sales region or models in which it was sold. For more information about the standard package in your region, please contact your dealer or sales representative.

Before Using the System Board

Before using the system board, prepare basic system components.

If you are installing the system board in a new system, you will need at least the following internal components.

- Memory module
- Storage devices such as hard disk drive, CD-ROM, etc.

You will also need external system peripherals you intend to use which will normally include at least a keyboard, a mouse and a video display monitor.

Chapter 1 - Introduction

Specifications

Processor	<p>BT101:</p> <ul style="list-style-type: none"> Intel® Atom™/Intel® Celeron® processors - E15: Intel® Atom™ E3815, Single Core, 0.5M Cache, 1.46GHz, 5W - E26: Intel® Atom™ E3826, Dual Core, 1M Cache, 1.46GHz, 7W - E45: Intel® Atom™ E3845, Quad Core, 2M Cache, 1.91GHz, 10W - J00: Intel® Celeron® J1900, Quad Core, 2M Cache, 2GHz (2.41GHz), 10W <ul style="list-style-type: none"> BGA 1170 packaging technology 22nm process technology <p>BT103:</p> <ul style="list-style-type: none"> Intel® Atom™/Intel® Celeron® processors - E15: Intel® Atom™ E3815, Single Core, 0.5M Cache, 1.46GHz, 5W - E25: Intel® Atom™ E3825, Dual Core, 1M Cache, 1.33GHz, 6W - E45: Intel® Atom™ E3845, Quad Core, 2M Cache, 1.91GHz, 10W - J00: Intel® Celeron® J1900, Quad Core, 2M Cache, 2GHz (2.41GHz), 10W <ul style="list-style-type: none"> BGA 1170 packaging technology 22nm process technology
Super I/O Address	<ul style="list-style-type: none"> NCT6106/4Eh
System Memory	<ul style="list-style-type: none"> Two 204-pin DDR3L SODIMM sockets (-E45/-E26/-J00) - up to 8GB system memory - dual channel memory interface One 204-pin DDR3L SODIMM socket (-E25/-E15) - up to 4GB system memory - single channel memory interface Supports DDR3L 1333MHz (-E45/-J00) Supports DDR3L 1066MHz (-E26/-E25/-E15) DRAM device technologies: 1Gb, 2Gb and 4Gb DDR3L DRAM technologies are supported for x8 and x16 devices, unbuffered, non-ECC
Expansion Interfaces	<ul style="list-style-type: none"> 1 PCIe x1 slot 1 Mini PCIe slot - Supports USB, PCIe and 3G signals - Supports mSATA - Supports half size or full size Mini PCIe card 1 SIM card socket
Graphics	<ul style="list-style-type: none"> Intel® HD Graphics Display ports: DVI-I and LVDS DVI-I: 24-bit, resolution up to 1920x1080 @60Hz LVDS: NXP PTN3460, 24-bit, dual channel, resolution up to 1920x1200 @60Hz Supports hardware acceleration for DirectX 11, OCL 1.2, OGL 4.0, H.264, MPEG2, MVC, VC-1, WMV9 and VP8 (supported version dependent on OS)
Audio	<ul style="list-style-type: none"> Realtek ALC888 5.1-channel High Definition Audio S/PDIF audio interface
LAN	<ul style="list-style-type: none"> 2 Intel® I210AT PCI Express Gigabit Ethernet controllers Integrated 10/100/1000 transceiver Fully compliant with IEEE 802.3, IEEE 802.3u, IEEE 802.3ab
Serial ATA	<ul style="list-style-type: none"> 2 SATA 2.0 ports with data transfer rate up to 3Gb/s - SATA port 0 provides adequate space for SATA DOM - SATA port 1 multiplexed with mSATA (Mini PCIe) Integrated Advanced Host Controller Interface (AHCI) controller
Rear Panel I/O Ports	<ul style="list-style-type: none"> 1 12V (BT101) or 19~24V (BT103) DC-in jack or 4-pin power connector* (optional) 1 DVI-I port 2 RJ45 LAN ports 2 USB 2.0 ports 1 USB 3.0 port Line-out jack
I/O Connectors	<ul style="list-style-type: none"> 2 connectors for 4 external USB 2.0 ports 4 connectors for 4 external serial ports (2.0mm pitch) <ul style="list-style-type: none"> - 1 RS232/RS422/485 (RS232 and/or power) - 3 RS232 1 LVDS LCD panel connector 1 LCD/inverter power connector 1 8-bit DIO and/or power connector 1 front audio connector for line-out and mic-in jacks 1 S/PDIF connector 1 PS/2 connector for keyboard/mouse port 1 LPC connector 1 SMBus connector 1 SPI connector* (optional) 1 LAN LED connector 2 Serial ATA connectors 2 Serial ATA power connectors 1 front panel connector 1 chassis intrusion connector 2 fan connectors
Trusted Platform Module - TPM* (optional)	<ul style="list-style-type: none"> Provides a Trusted PC for secure transactions Provides software license protection, enforcement and password protection
BIOS	<ul style="list-style-type: none"> AMI BIOS - 64Mbit SPI BIOS
Power Consumption	<ul style="list-style-type: none"> BT101-BN-E45: 13.20W with E3845 at 1.91GHz and 2x 4GB DDR3L SODIMM BT103-BN-E45: 13.68W with E3845 at 1.91GHz and 2x 4GB DDR3L SODIMM
Energy Efficient Design	<ul style="list-style-type: none"> Supports ErP Lot6 power saving* (optional) Supports ACPI System Power Management Wake-On-Events include: <ul style="list-style-type: none"> - Wake-On-USB/PS/2 KB/Mouse* (optional) - Wake-On-LAN - RTC timer to power-on the system AC power failure recovery
Damage Free Intelligence	<ul style="list-style-type: none"> Monitors CPU/system temperature and overheat alarm Monitors VCore/12V/5V/DDR voltages and failure alarm Monitors CPU/system fan speed and failure alarm Read back capability that displays temperature, voltage and fan speed
WatchDog Timer	<ul style="list-style-type: none"> Watchdog timeout programmable via software from 1 to 255 seconds

OS Support	<ul style="list-style-type: none"> • Windows 7 Ultimate x86 & SP1 (32-bit) • Windows 7 Ultimate x64 & SP1 (64-bit) • Windows 8.1 Enterprise x86 (32-bit) • Windows 8.1 Enterprise x64 (64-bit) • Windows 8.1 Embedded Pro x86 (32-bit) • Windows 8.1 Embedded Pro x64 (64-bit)
Temperature	<ul style="list-style-type: none"> • Operating <ul style="list-style-type: none"> : 0°C to 60°C - Celeron (Fanless) : -20°C to 70°C - Atom (Fanless with air flow) : -40°C to 85°C - Atom (Fanless with air flow) • Storage: -40°C to 85°C
Humidity	<ul style="list-style-type: none"> • 5% to 90%
Dimensions	<ul style="list-style-type: none"> • Mini-ITX form factor • 170mm (6.7") x 170mm (6.7")
Certification	<ul style="list-style-type: none"> • CE, FCC Class B, RoHS, UL

**Note:**

*Optional and is not supported in standard model. Please contact your sales representative for more information.

Features

• Watchdog Timer

The Watchdog Timer function allows your application to regularly “clear” the system at the set time interval. If the system hangs or fails to function, it will reset at the set time interval so that your system will continue to operate.

• DDR3L

DDR3L is a higher performance DDR3 SDRAM interface providing less voltage and higher speed successor. DDR3L SDRAM modules support 1066/1333MHz for DDR modules. DDR3L delivers increased system bandwidth and improved performance to provide its higher bandwidth and its increase in performance at a lower power.

• Graphics

The integrated Intel® HD graphics engine delivers an excellent blend of graphics performance and features to meet business needs. It provides excellent video and 3D graphics with outstanding graphics responsiveness. These enhancements deliver the performance and compatibility needed for today's and tomorrow's business applications. Supports DVI-I and LVDS interfaces for display outputs.

• PCI Express

PCI Express is a high bandwidth I/O infrastructure that possesses the ability to scale speeds by forming multiple lanes. The PCI Express architecture also supports high performance graphics infrastructure by enhancing the capability of a PCIe x1.

• Serial ATA

Serial ATA is a storage interface that is compliant with SATA 1.0a specification. With speed of up to 3Gb/s (SATA 2.0), it improves hard drive performance faster than the standard parallel ATA whose data transfer rate is 100MB/s.

• Gigabit LAN

Two Intel® I210AT PCI Express Gigabit Ethernet controllers support up to 1Gbps data transmission.

• Audio

The Realtek ALC888 audio codec provides 5.1-channel High Definition audio output.

- **Wake-On-LAN**

This feature allows the network to remotely wake up a Soft Power Down (Soft-Off) PC. It is supported via the onboard LAN port or via a PCI LAN card that uses the PCI PME (Power Management Event) signal. However, if your system is in the Suspend mode, you can power-on the system only through an IRQ or DMA interrupt.



Important:

The 5V_standby power source of your power supply must support $\geq 720\text{mA}$.

- **Wake-On-PS/2 (optional)**

This function allows you to use the PS/2 keyboard or PS/2 mouse to power-on the system.



Important:

The 5V_standby power source of your power supply must support $\geq 720\text{mA}$.

- **Wake-On-USB (optional)**

This function allows you to use a USB keyboard or USB mouse to wake up a system from the S3 (STR - Suspend To RAM) state.



Important:

If you are using the Wake-On-USB Keyboard/Mouse function for 2 USB ports, the 5V_standby power source of your power supply must support $\geq 1.5\text{A}$. For 3 or more USB ports, the 5V_standby power source of your power supply must support $\geq 2\text{A}$.

- **ACPI STR**

The system board is designed to meet the ACPI (Advanced Configuration and Power Interface) specification. ACPI has energy saving features that enables PCs to implement Power Management and Plug-and-Play with operating systems that support OS Direct Power Management. ACPI when enabled in the Power Management Setup will allow you to use the Suspend to RAM function.

With the Suspend to RAM function enabled, you can power-off the system at once by pressing the power button or selecting "Standby" when you shut down Windows® without having to go through the sometimes tiresome process of closing files, applications and operating system. This is because the system is capable of storing all programs and data files during the entire operating session into RAM (Random Access Memory) when it powers-off. The operating session will resume exactly where you left off the next time you power-on the system.



Important:

The 5V_standby power source of your power supply must support $\geq 720\text{mA}$.

- **RTC Timer**

The RTC installed on the system board allows your system to automatically power-on on the set date and time.

- **Power Failure Recovery**

When power returns after an AC power failure, you may choose to either power-on the system manually or let the system power-on automatically.

- **USB**

The system board supports the new USB 3.0. It is capable of running at a maximum transmission speed of up to 5 Gbit/s (625 MB/s) and is faster than USB 2.0 (480 Mbit/s, or 60 MB/s) and USB 1.1 (12Mb/s). USB 3.0 reduces the time required for data transmission, reduces power consumption, and is backward compatible with USB 2.0. It is a marked improvement in device transfer speeds between your computer and a wide range of simultaneously accessible external Plug and Play peripherals.

Chapter 2 - Hardware Installation

Board Layout

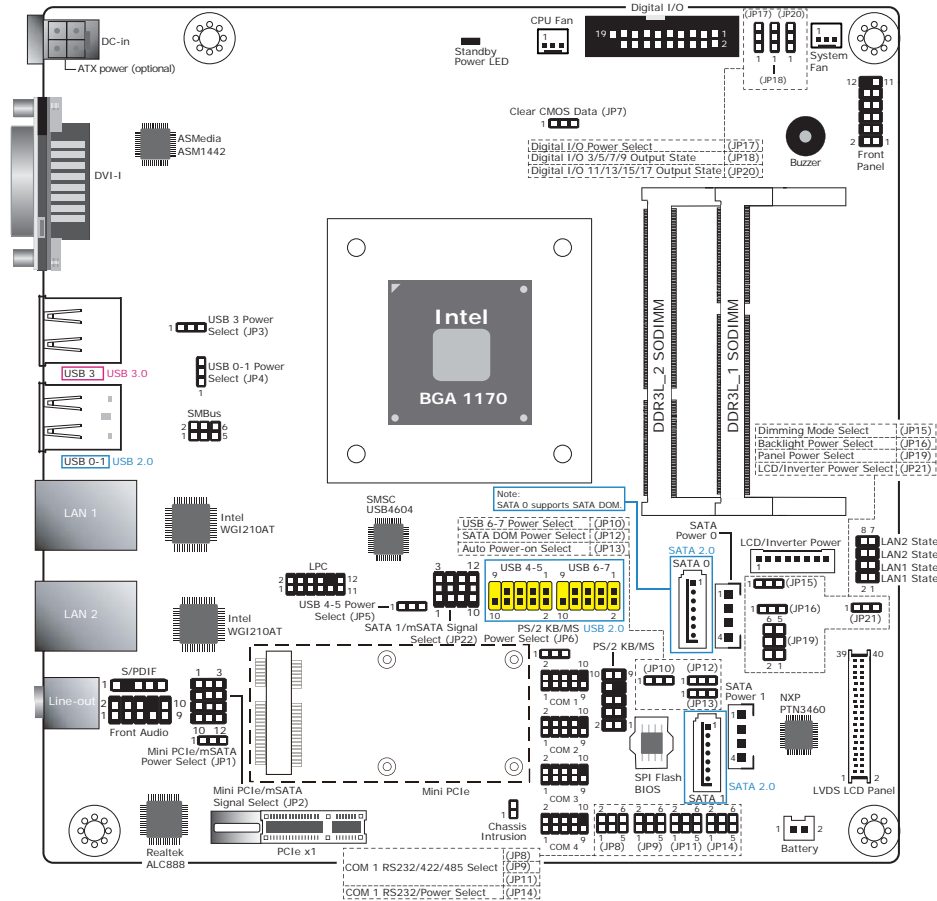

Important:

Electrostatic discharge (ESD) can damage your board, processor, disk drives, add-in boards, and other components. Perform installation procedures at an ESD workstation only. If such a station is not available, you can provide some ESD protection by wearing an antistatic wrist strap and attaching it to a metal part of the system chassis. If a wrist strap is unavailable, establish and maintain contact with the system chassis throughout any procedures requiring ESD protection.

System Memory



Important:

When the Standby Power LED lights red, it indicates that there is power on the system board. Power-off the PC then unplug the power cord prior to installing any devices. Failure to do so will cause severe damage to the motherboard and components.

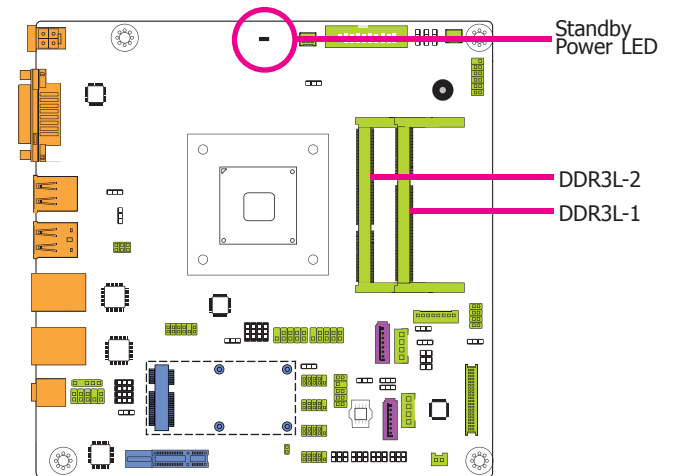
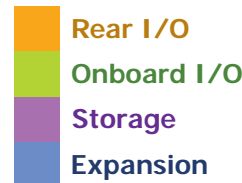

Features

- Two 204-pin DDR3L SODIMM sockets (-E45/-E26/-J00)
 - up to 8GB system memory
 - dual channel memory interface
- One 204-pin DDR3L SODIMM socket (-E25/-E15)
 - up to 4GB system memory
 - single channel memory interface
- Supports DDR3L 1333MHz (-E45/-J00)
- Supports DDR3L 1066MHz (-E26/-E25/-E15)

The system board supports the following memory interface.

Single Channel (SC)

Data will be accessed in chunks of 64 bits (8B) from the memory channels.

Dual Channel (DC)

Data will be accessed in chunks of 128 bits from the memory channels. Dual channel provides better system performance because it doubles the data transfer rate.



Important:

1. The DDR3L sockets support no mixed Raw Card.
2. For dual channel population, the two channels must be populated the same DRAM density, chip width, number ranks and dimm speed.

The memory data rate is fixed for each SKU. For example, a SKU that supports 1333 MT/s will only run at 1333 MT/s, nothing lower. For single channel use cases, Channel 0 must be used.

Raw Card Support Matrix for 2 SODIMM Configuration--DDR3L

	Raw Card B	Raw Card C	Raw Card F
SODIMM0	B	C	F
SODIMM1	B	C	F

- DDR3L SO-DIMM Modules (unbuffered)
 - Raw Card B = 1 rank of x8 SDRAM
 - Raw Card C = 1 rank of x16 SDRAM
 - Raw Card F = 2 ranks of x8 SDRAM

Supported DDR3L SO-DIMM Size

DRAM Chip Density	Module Size	# of chips needed	DRAM Chip Data Width	Data Bus Width	# of Ranks needed	# of chips /rank
1Gbit	2GB	16	x8	x64	2	8
2Gbit	1GB	4	x16	x64	1	4
2Gbit	2GB	8	x8	x64	1	8
2Gbit	4GB	16	x8	x64	2	8
4Gbit	4GB	8	x8	x64	1	8
4Gbit	8GB	16	x8	x64	2	8

Installing the DIMM Module



Note:

The system board used in the following illustrations may not resemble the actual board. These illustrations are for reference only.

1. Make sure the PC and all other peripheral devices connected to it has been powered down.
2. Disconnect all power cords and cables.
3. Locate the SODIMM socket on the system board.
4. Note the key on the socket. The key ensures the module can be plugged into the socket in only one direction.

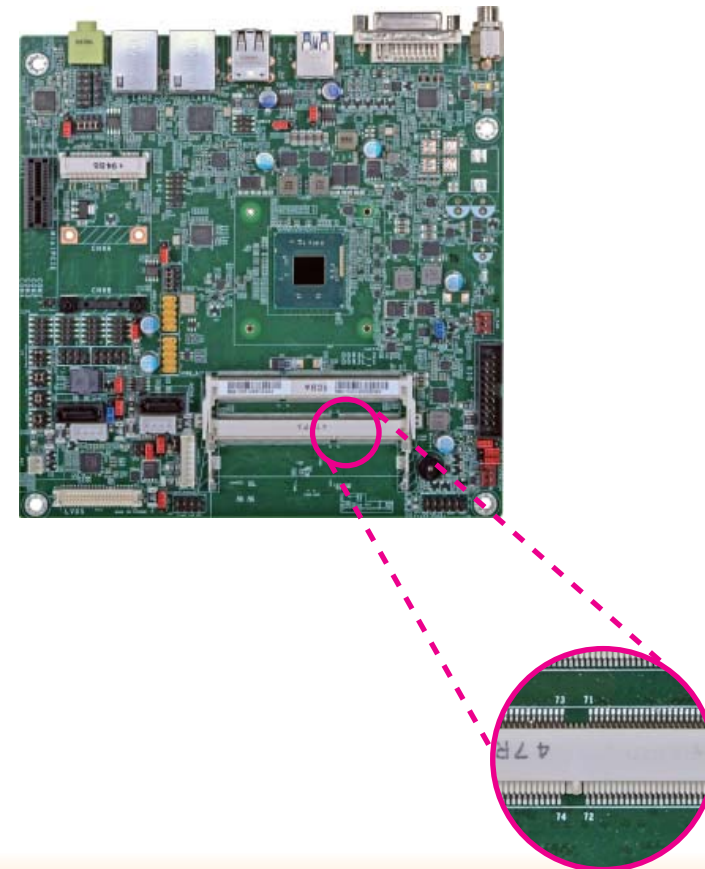

- Grasping the module by its edges, align the module into the socket at an approximately 30 degrees angle. Apply firm even pressure to each end of the module until it slips down into the socket. The contact fingers on the edge of the module will almost completely disappear inside the socket.



- Push down the module until the clips at each end of the socket lock into position. You will hear a distinctive "click", indicating the module is correctly locked into position.

**Important:**

When installing one DDR3L SODIMM only, make sure to install it into the SODIMM 1 socket.

Installing the Heat Sink

The CPU must be kept cool by using a CPU fan with heat sink. Without sufficient air circulation across the CPU and heat sink, the CPU will overheat damaging both the CPU and system board.

- On the solder side of the board, match the retention module base to the mounting holes around the CPU socket.

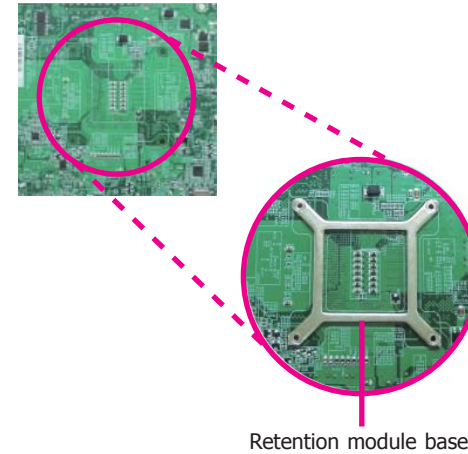

- Turn to the component side of the board making sure the retention module base is positioned and fitted properly under the board.
- Apply a thin layer of thermal paste on top of the CPU. Do not spread the paste all over the surface. When you later place the heat sink on top, the compound will disperse evenly.

- Place the heat sink assembly on top of the CPU. The 4 screws around the heat sink must match the screw holes of the retention module base. We strongly recommend using this type of heat sink assembly because it provides adequate cooling to the components of the system board.

Turn each Phillips head screw half way down first to initially stabilize the heat sink onto the board, then finally tighten each screw.



Important:

Do not turn the first screw all the way down followed by the next and so on. This is to avoid imbalance which might cause cracks or fractures to the CPU and/or heat sink assembly.

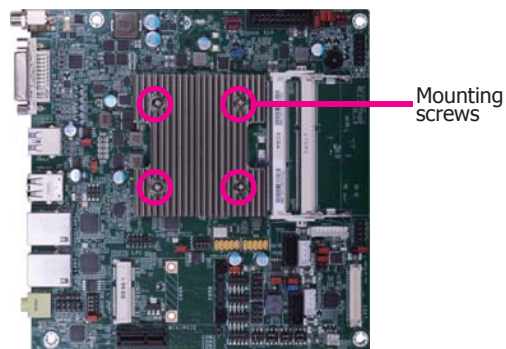
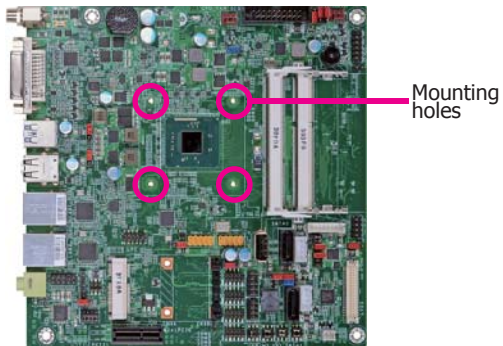

Jumper Settings

Clear CMOS Data

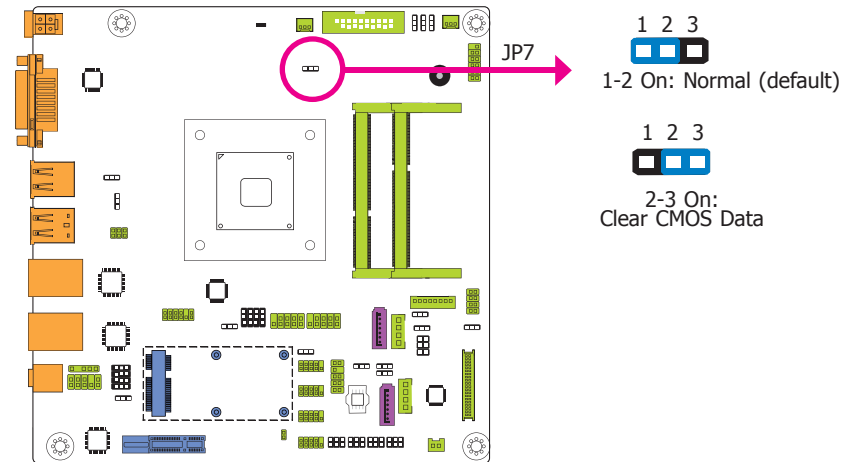

If you encounter that CMOS data becomes corrupted, you can reconfigure the system with the default values stored in the ROM BIOS.

To load the default values stored in the ROM BIOS, please follow the steps below.

- Power-off the system and unplug the power cord.
- Set JP7 pins 2 and 3 to On. Wait for a few seconds and set JP7 back to its default setting, pins 1 and 2 On.
- Now plug the power cord and power-on the system.

PS/2 Keyboard/Mouse Power Select

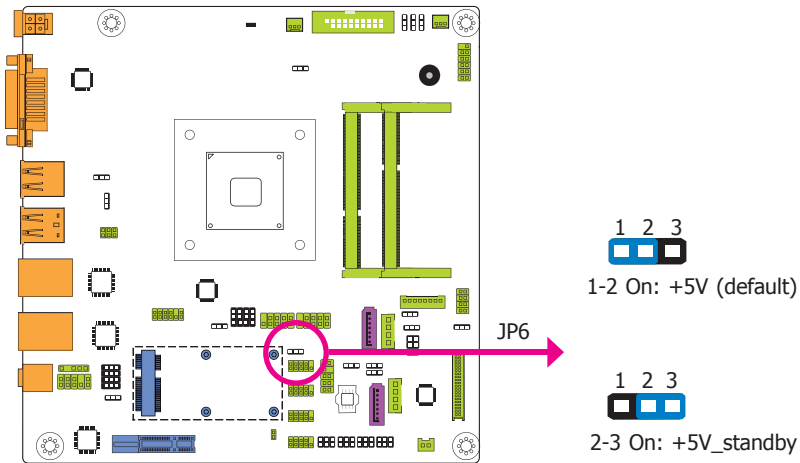

JP6 is used to select the power of the PS/2 keyboard/mouse port. Selecting +5V_standby will allow you to use the PS/2 keyboard or PS/2 mouse to wake up the system.

**Important:**

The +5VSB power source of your power supply must support $\geq 720\text{mA}$.

USB Power Select

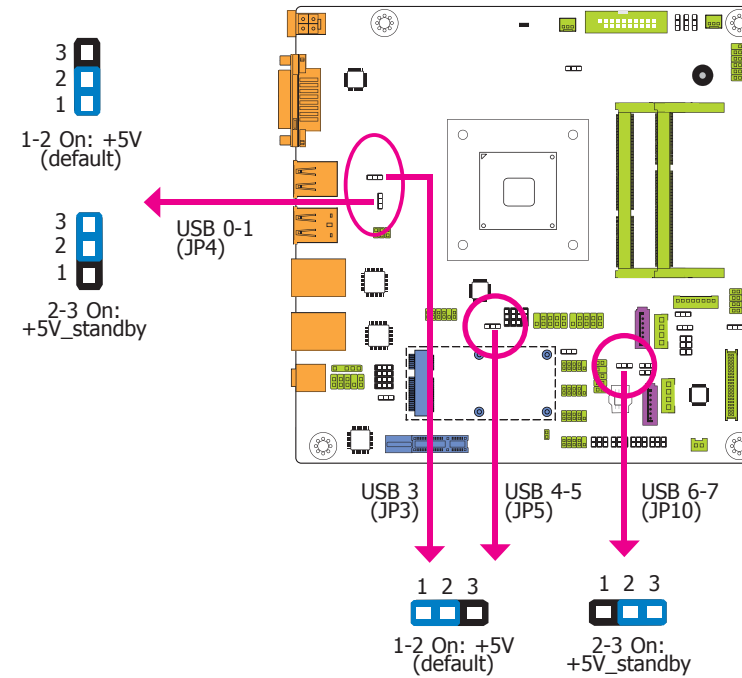

JP3, JP4, JP5 and JP10 are used to select the power of the USB ports. Selecting +5V_standby will allow you to use a USB device to wake up the system.

**Important:**

If you are using the Wake-On-USB Keyboard/Mouse function for 2 USB ports, the +5V_standby power source of your power supply must support $\geq 1.5\text{A}$. For 3 or more USB ports, the +5V_standby power source of your power supply must support $\geq 2\text{A}$.

LCD/Inverter Power Select

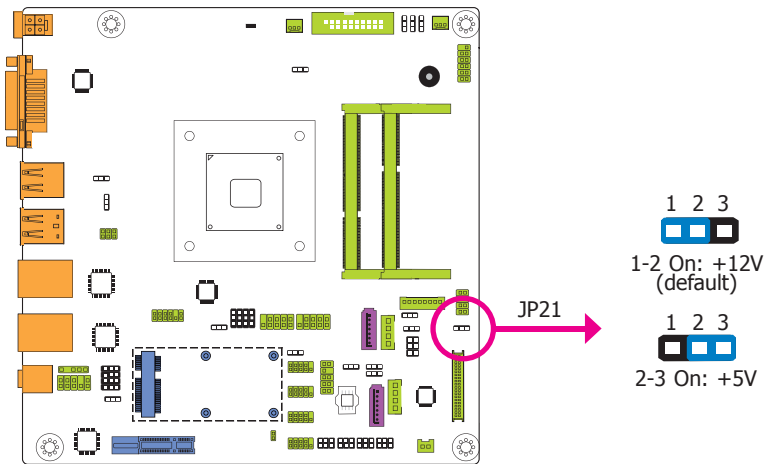

JP21 is used to select the power level of LVDS LCD inverter connector.

Panel Power Select

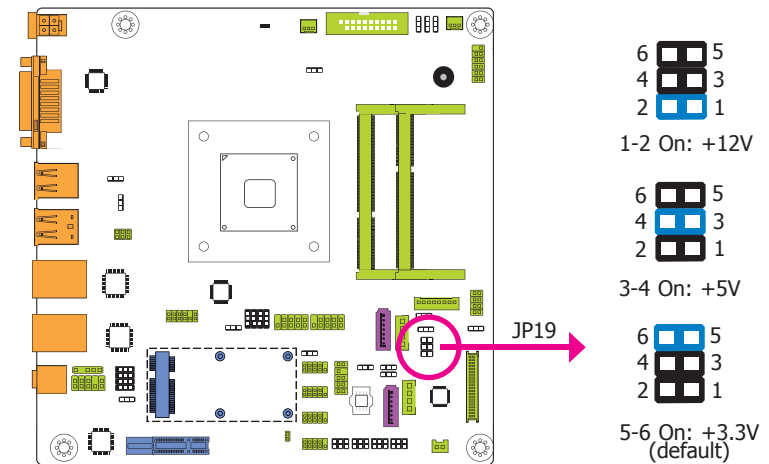

JP19 is used to select the power supplied with the LCD panel.

**Important:**

Before powering-on the system, make sure that the power settings of JP19 match the LCD panel's specification. Selecting the incorrect voltage will seriously damage the LCD panel.

Backlight Power Select

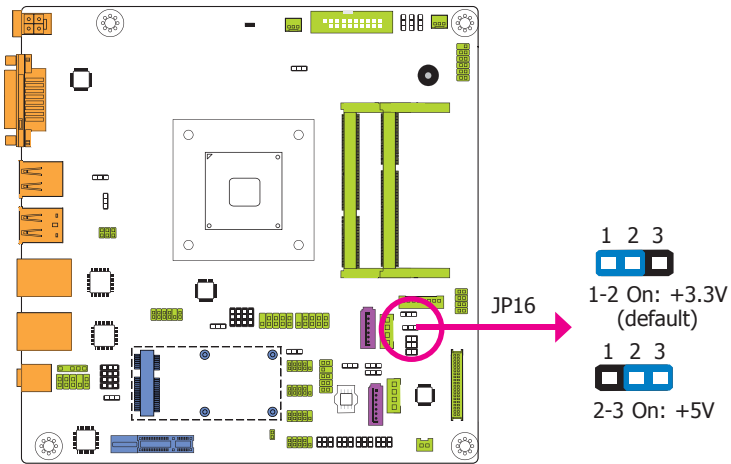

JP16 is used to select the power level of backlight control: +3.3V (default) or +5V.

**Important:**

Before powering-on the system, make sure that the power settings of JP16 match the power specification of backlight control. Selecting the incorrect voltage will seriously damage the backlight.

Auto Power-on Select

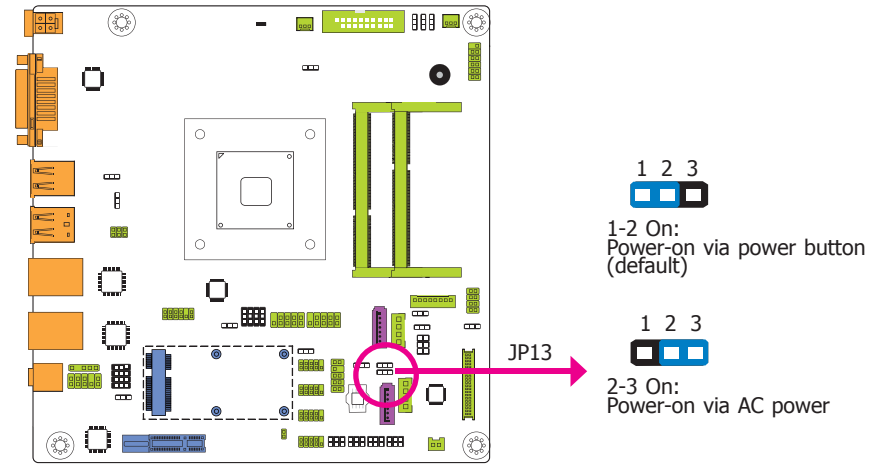

JP13 is used to select the method of powering-on the system. If you want the system to power-on whenever AC power comes in, set JP13 pins 2 and 3 to On. If you want to use the power button, set pins 1 and 2 to On.

When using JP13 "Power On" feature to power the system back on after a power failure occurs, the system may not power on if the power lost is resumed within 5 seconds (power flicker).

COM 1 RS232/422/485 Select

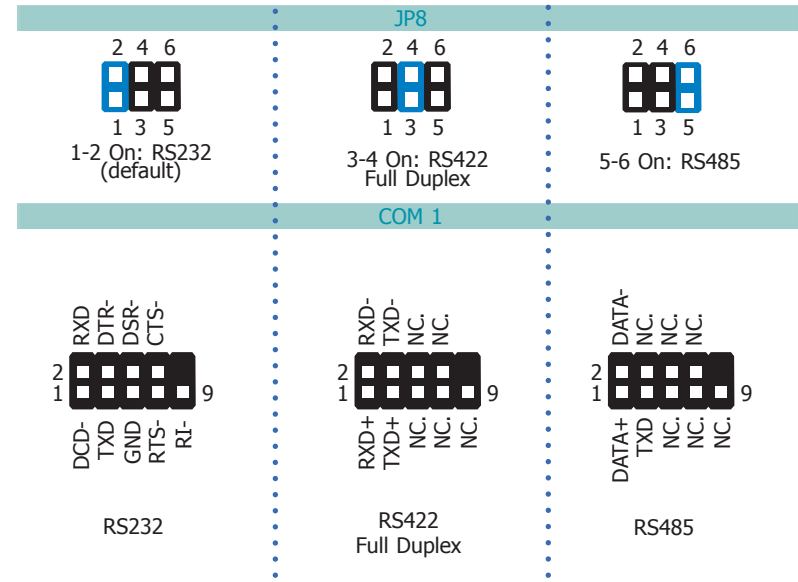
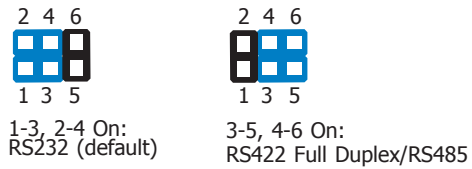
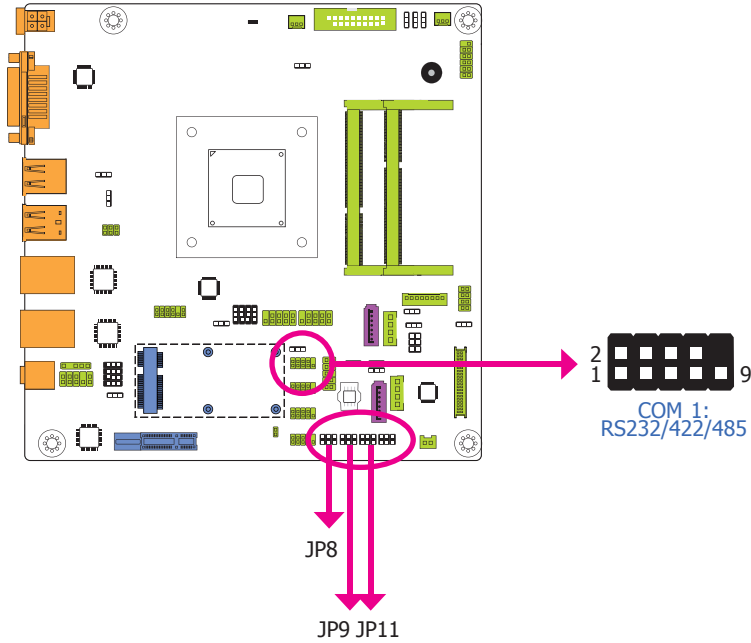

Note: When COM 1 RS232/422/485 is selected, JP9 and JP11 must be set in accordance to JP8.

JP8, JP9 and JP11 are used to configure the Serial COM port 1 to RS232, RS422 (Full Duplex) or RS485. The pin functions of the Serial COM port 1 will vary according to these jumpers' setting.

COM 1 RS232/Power Select

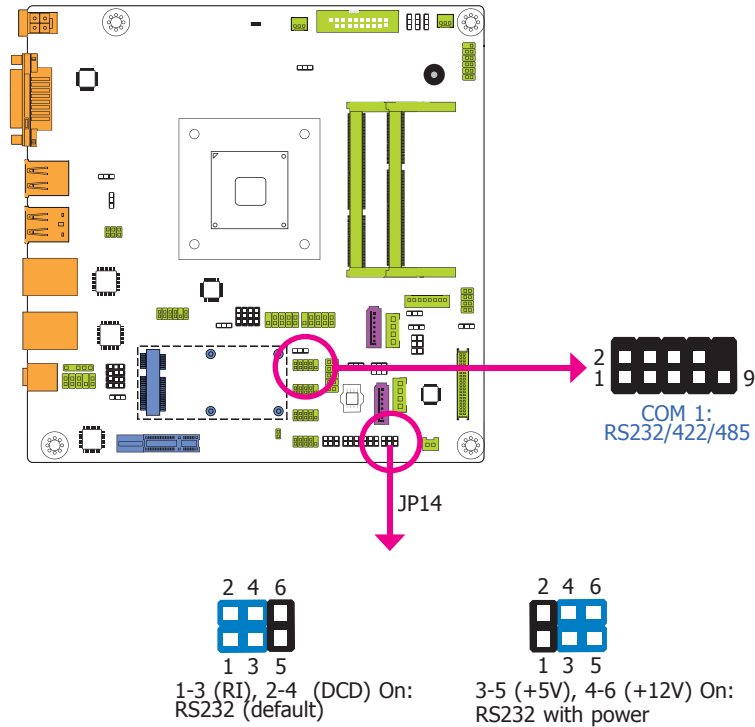

JP14 is used to configure the Serial COM port 1 to pure RS232 or RS232 with power.

SATA DOM Power Select

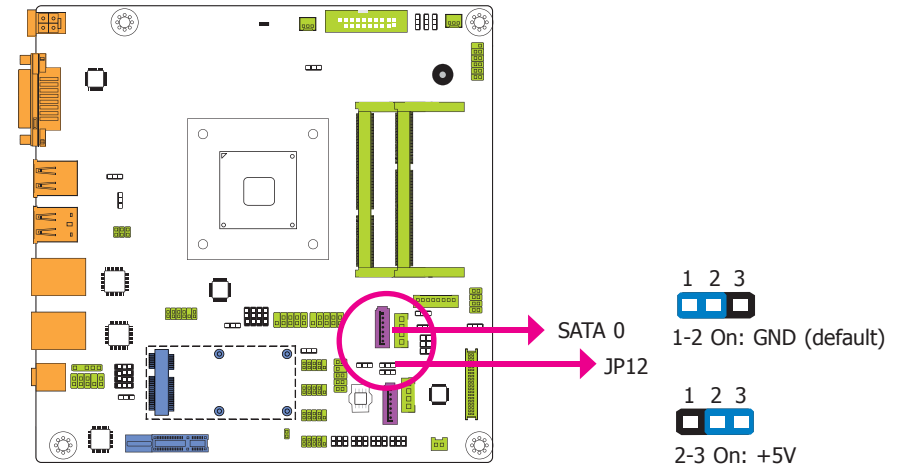

JP12 is used to select the power level of SATA DOM.

Note: SATA port 0 provides adequate space for SATA DOM.

Digital I/O Power Select

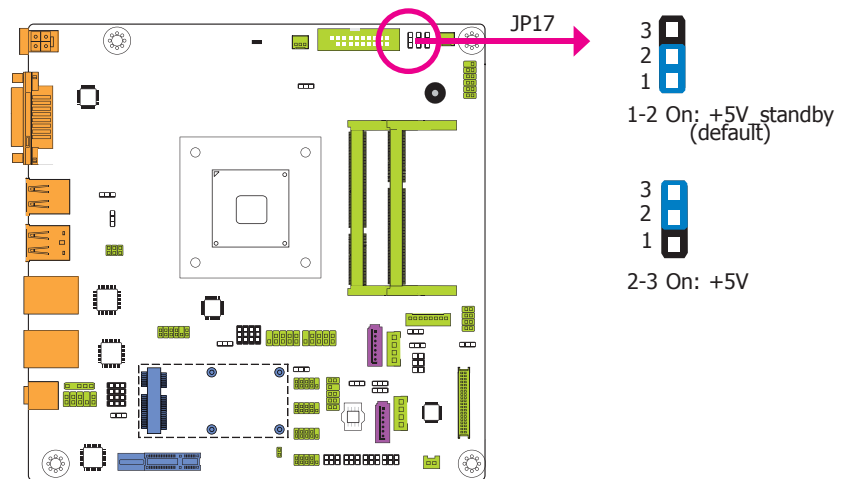

JP17 is used to select the power of Digital I/O signal.

Digital I/O Output State

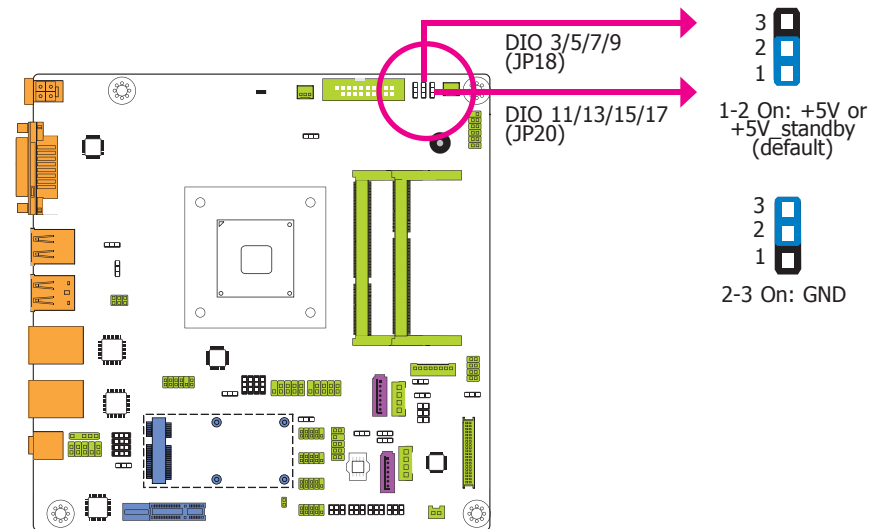

Based on the power level of DIO (Digital I/O) selected on JP17, JP18 (DIO pin 3/5/7/9) and JP20 (DIO pin 11/13/15/17) are used to select the output state of Digital I/O: pull high or pull low. When selecting pull high, the power selection will be the same as the JP17's setting.

Mini PCIe/mSATA Signal Select

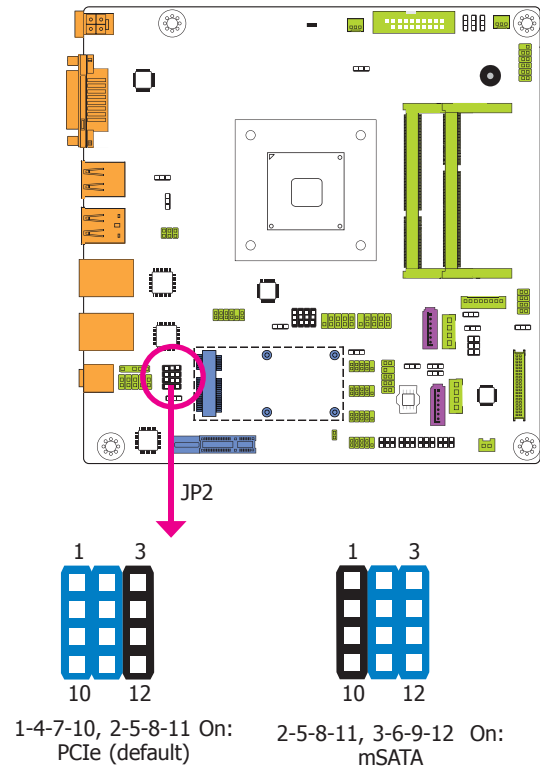

JP2 is used to select the Mini PCIe signal.

Mini PCIe/mSATA Power Select

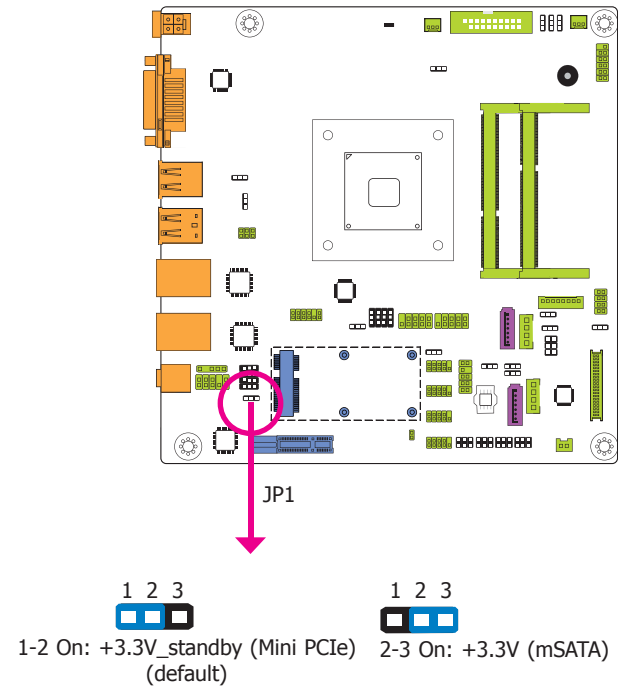

JP1 is used to select the power supplied with the Mini PCIe.

SATA 1/mSATA Signal Select

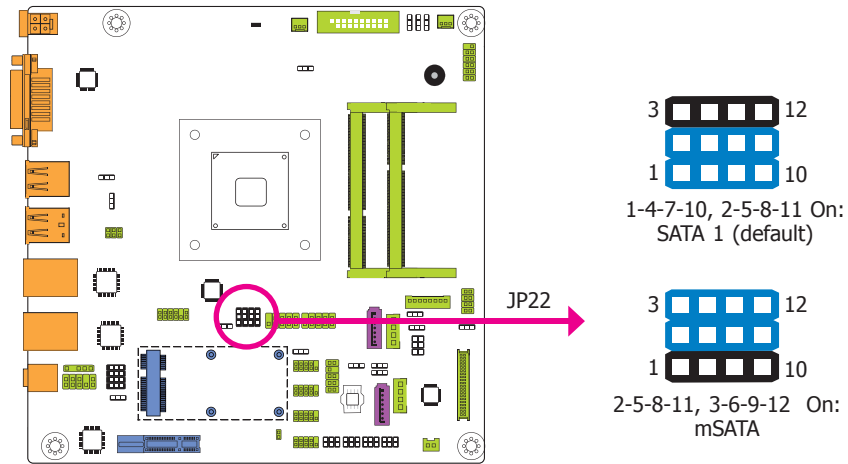

JP22 is designed to select the SATA or mSATA signal.

Dimming Mode Select

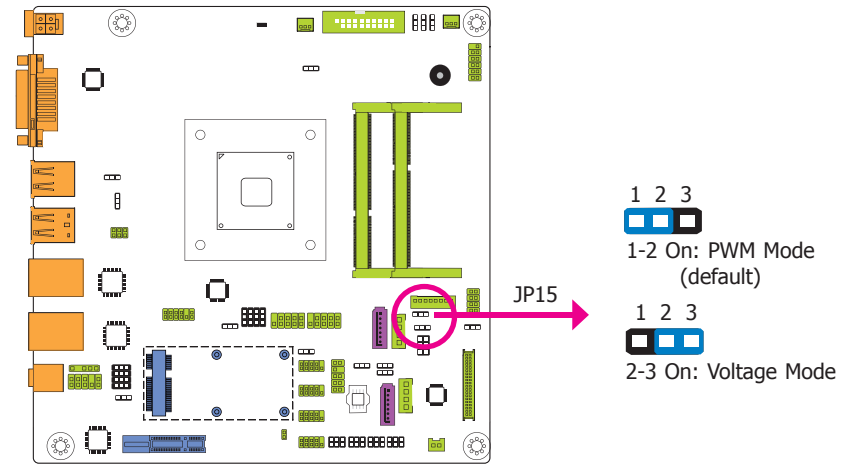

JP15 allows you to select the mode for the lightness control of the LVDS panel.

**Important:**

You need to refer to your panel's user guide to determine the type of mode (PWM or Voltage) most appropriate for your panel.

Rear Panel I/O Ports



The rear panel I/O ports consist of the following:

- 1 12V (BT101) or 19~24V (BT103) DC-in jack or 4-pin power connector* (optional)
- 1 DVI-I port
- 2 RJ45 LAN ports
- 2 USB 2.0 ports
- 1 USB 3.0 port
- Line-out jack

12V DC-in (BT101)/19~24V DC-in (BT103)

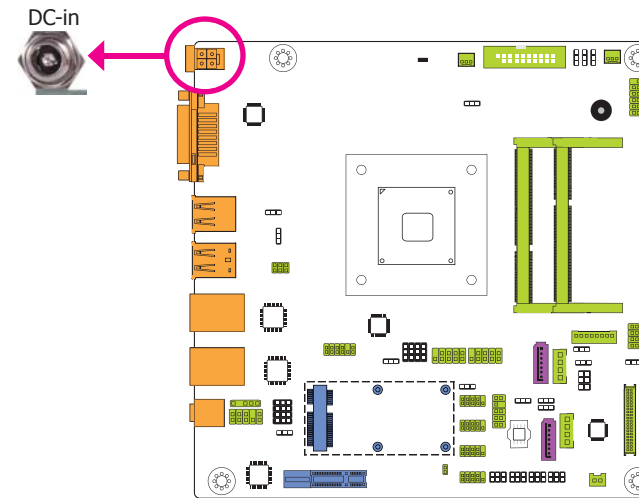

This jack provides maximum of 100W/120W power and is considered a low power solution. Connect a DC power cord to this jack. Use a power adapter with 12V (for BT101) or 19~24V (for BT103) DC output voltage. Using a voltage higher than the recommended one may fail to boot the system or cause damage to the system board.

The 12V (for BT101) or 19~24V (for BT103) DC-in jack on the system board co-lays with a 4-pin power connector (optional) as the figure displayed below.

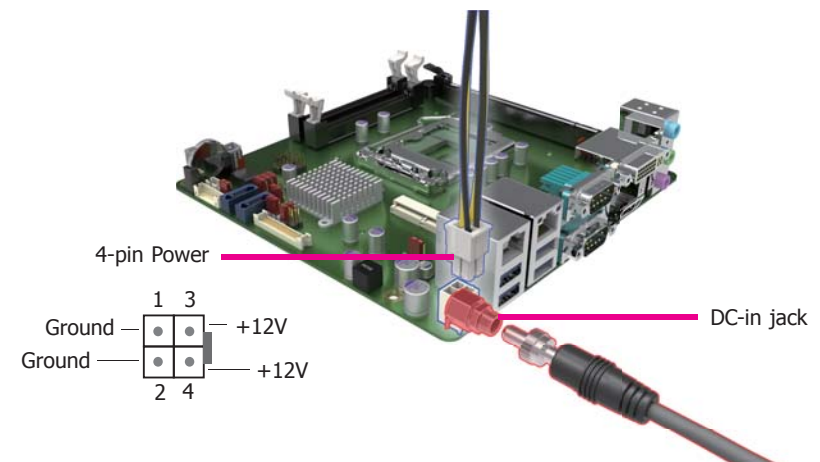

Graphics Interface

The display port consists of the following:

- 1 DVI-I port

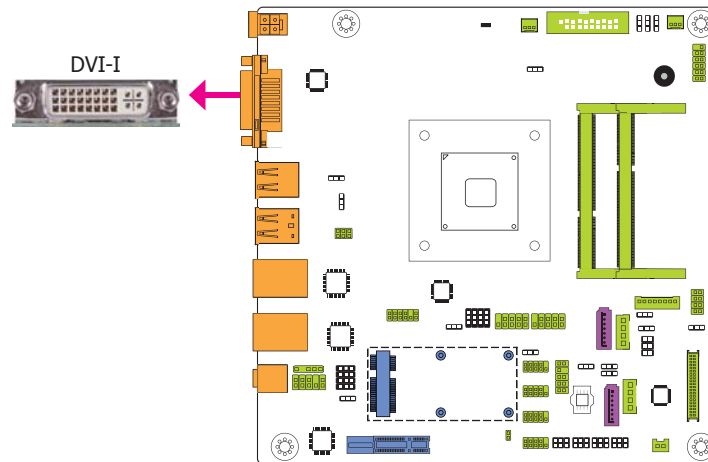

DVI-I Port

The DVI-I port is used to connect an LCD monitor.

Connect the display device's cable connector to the DVI-I port. After plugging the cable connector into the port, gently tighten the cable screws to hold the connector in place.

BIOS Setting

Configure the display devices in the Chipset menu ("System Agent Configuration" submenu) of the BIOS. Refer to the chapter 3 for more information.

RJ45 LAN Ports

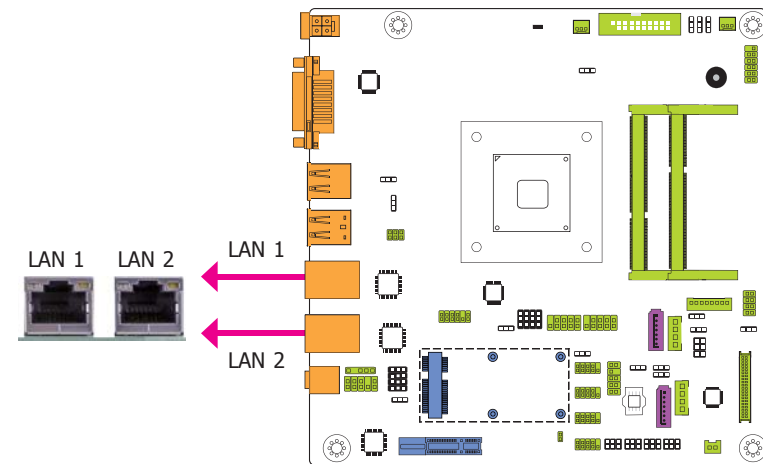

Features

- Two Intel® I210AT PCI Express Gigabit Ethernet controllers

The two LAN ports allow the system board to connect to a local area network by means of a network hub.

BIOS Setting

Configure the onboard LAN ports in the Chipset menu ("PCH-IO Configuration" submenu) of the BIOS. Refer to the chapter 3 for more information.

Driver Installation

Install the LAN drivers. Refer to the chapter 4 for more information.

USB Ports

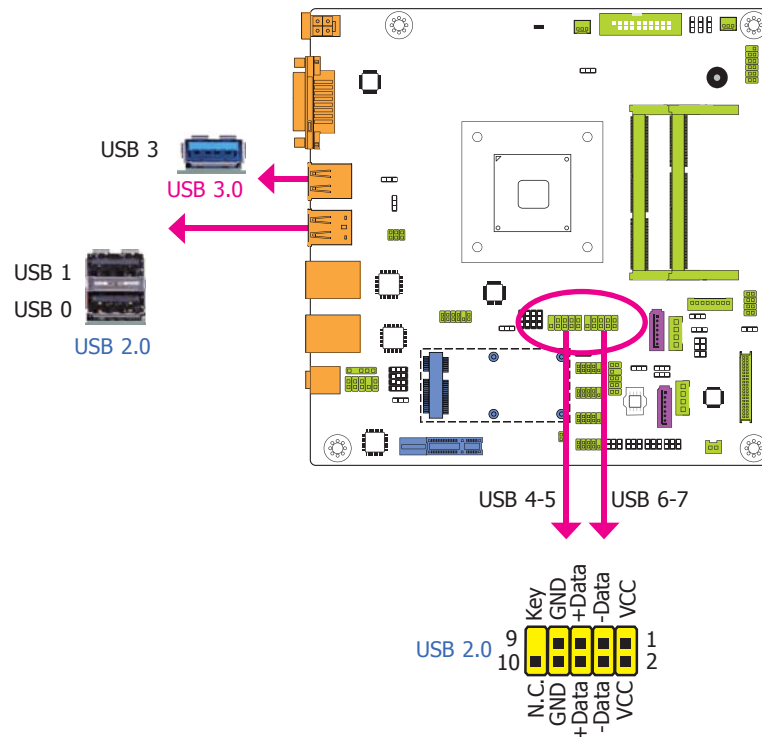

The USB device allows data exchange between your computer and a wide range of simultaneously accessible external Plug and Play peripherals.

The system board is equipped with one onboard USB 3.0 port (USB 3) and two onboard USB 2.0 ports (USB 0-1) at the rear panel I/O ports. The 10-pin connectors allow you to connect 4 additional USB 2.0/1.1 ports (USB 4-5/6-7). The additional USB ports may be mounted on a card-edge bracket. Install the card-edge bracket to an available slot at the rear of the system chassis and then insert the USB port cables to a connector.

BIOS Setting

Configure these onboard USB devices in the Advanced menu ("USB Configuration" submenu) of the BIOS. Refer to the chapter 3 for more information.

Driver Installation

You may need to install the proper drivers in your system operation to use the USB device. Refer to your operating system's manual or documentation for more information.

Wake-On-USB Keyboard/Mouse

The Wake-On-USB Keyboard/Mouse function allows you to use a USB keyboard or USB mouse to wake up a system from the S3 (STR - Suspend To RAM) state. To use this function:

- **Jumper Setting**

JP3, JP4, JP5 and JP10 must be set to "2-3 On: +5V_standby". Refer to "USB Power Select" in this chapter for more information.



Important:

1. If you are using the Wake-On-USB Keyboard/Mouse function for 2 USB ports, the +5V_standby power source of your power supply must support $\geq 1.5A$. For 3 or more USB ports, the +5V_standby power source of your power supply must support $\geq 2A$.
2. When installing Windows 7, only native USB 2.0 devices (USB port 0 to USB port 3) can operate under DOS mode. Please refer to the following tables for more information on the type of USB ports.

Table 1. OS Selection

Operation Environment for Customers	DOS	Windows 7	Windows 8.x	Linux
OS Selection in the BIOS Advanced Menu	Windows 8.x	Windows 7	Windows 8.x	Windows 8.x
Available USB ports	All	When installing Windows 7 first time, only native USB 2.0 ports can work. Please refer to the USB type in table 2 below.	All	All

Table 2. The Type of USB Ports

Model Name	BT101/BT103
USB 3.0	Native
USB 0	Native
USB 1	Native
USB 2	Native (share with USB 3.0 port)
USB 3	Native
USB 4	HSIC port 0
USB 5	HSIC port 1
USB 6	HSIC port 2
USB 7	HSIC port 3

Audio

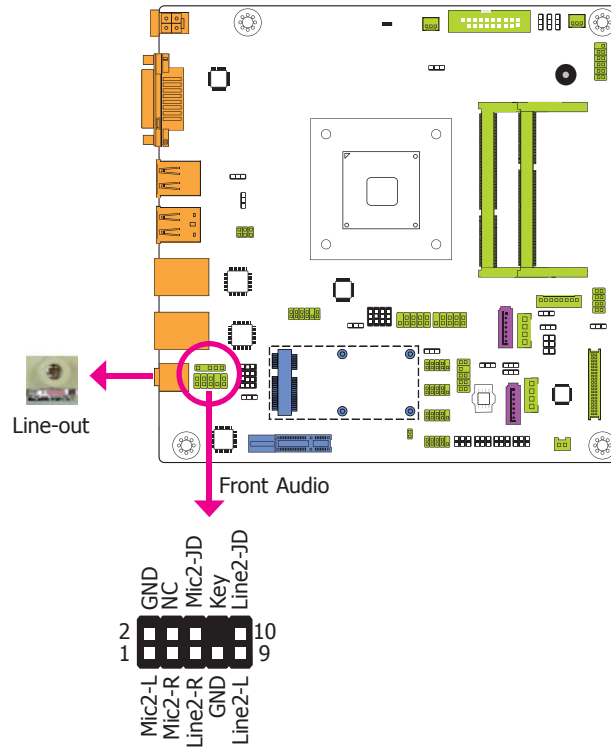

Rear Audio

The system board is equipped with 1 audio jack. This jack is a one-hole connecting interface for inserting a plug.

- Line-out Jack (Lime)
This jack is used to connect a headphone or external speakers.

Front Audio

The front audio connector allows you to connect to the second line-out and mic-in jacks that are at the front panel of your system.

Driver Installation

Install the audio driver. Refer to the chapter 4 for more information.

I/O Connectors

SATA (Serial ATA) Connectors

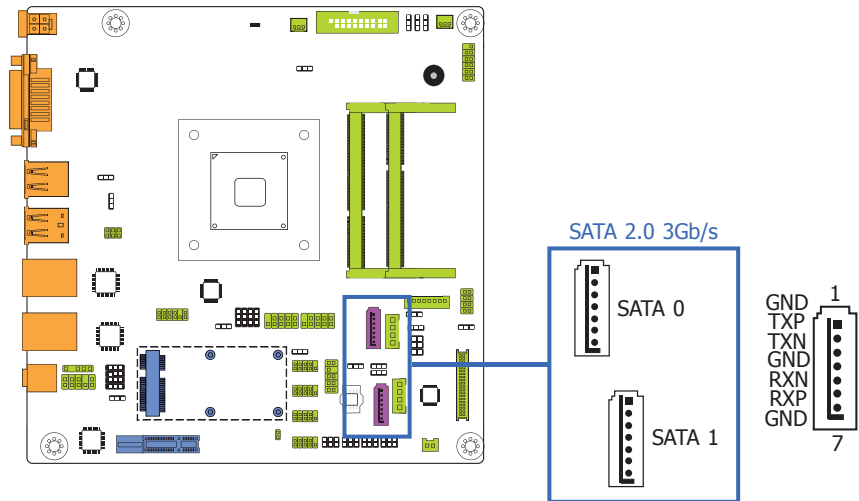

Features

- 2 Serial ATA 2.0 ports with data transfer rate up to 3Gb/s (SATA 0 and SATA 1)
- Integrated Advanced Host Controller Interface (AHCI) controller

The Serial ATA connectors are used to connect Serial ATA devices. Connect one end of the Serial ATA data cable to a SATA connector and the other end to your Serial ATA device.

BIOS Setting

Configure the Serial ATA drives in the Advanced menu ("SATA Configuration" submenu) of the BIOS. Refer to the chapter 3 for more information.



Note:
SATA port 0 provides adequate space for SATA DOM.

SATA (Serial ATA) Power Connectors

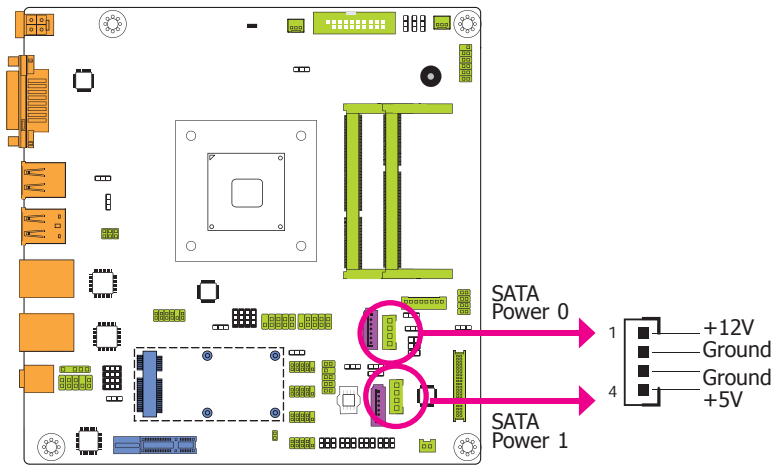

The SATA power connectors supply power to the SATA drive. Connect one end of the provided power cable to the SATA power connector and the other end to your storage device.

Digital I/O and/or Power Connector

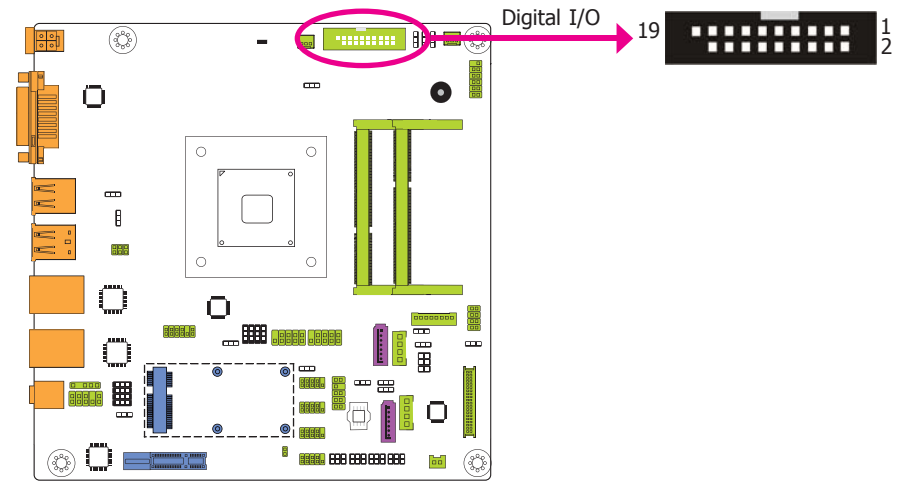

The 8-bit Digital I/O connector provides powering-on function to external devices that are connected to these connectors. The pin functions of the 8-bit digital I/O connector are listed below.

Digital I/O Connector

Pins	Pin Assignment	Pins	Pin Assignment
1	GND	2	+12V
3	DIO7	4	+12V
5	DIO6	6	GND
7	DIO5	8	+5V
9	DIO4	10	+5V
11	DIO3	12	GND
13	DIO2	14	+5V_Standby
15	DIO1	16	+5V_Standby
17	DIO0	18	GND
19	GND		

Cooling Fan Connectors

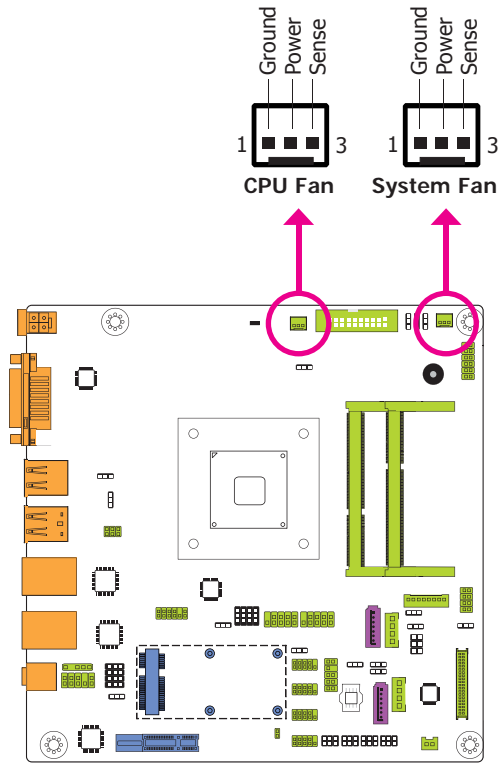

The fan connectors are used to connect cooling fans. The cooling fans will provide adequate airflow throughout the chassis to prevent overheating the CPU and system board components.

BIOS Setting

The Advanced menu ("PC Health Status" submenu) of the BIOS will display the current speed of the cooling fans. Refer to the chapter 3 for more information.

Front Panel Connector

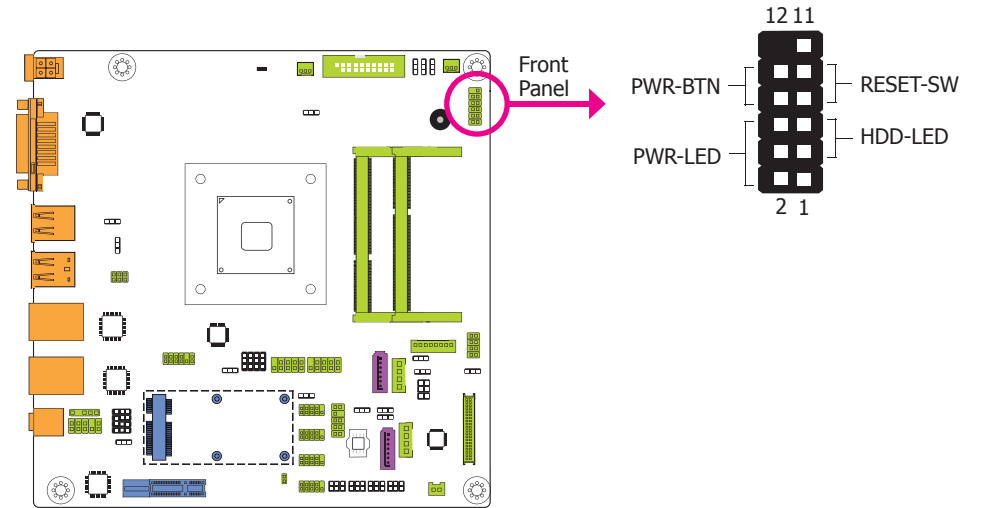

HDD-LED - HDD LED

This LED will light when the hard drive is being accessed.

RESET-SW - Reset Switch

This switch allows you to reboot without having to power off the system.

PWR-BTN - Power Switch

This switch is used to power on or off the system.

PWR-LED - Power/Standby LED

When the system's power is on, this LED will light. When the system is in the S1 (POS - Power On Suspend) state, it will blink every second. When the system is in the S3 (STR - Suspend To RAM) state, it will blink every 4 seconds.

	Pin	Pin Assignment		Pin	Pin Assignment
HDD-LED	3	HDD Power	PWR-LED	2	LED Power
	5	Signal		4	LED Power
RESET-SW	7	Ground	PWR-BTN	6	Signal
	9	RST Signal		8	Ground
	11	N.C.		10	Signal

COM (Serial) Ports

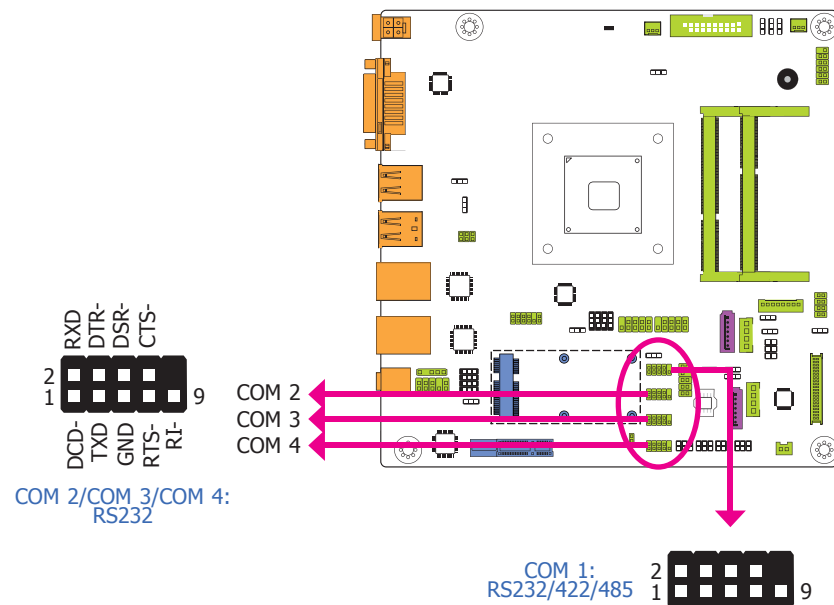

Important:

When COM 1 RS232/422/485 is selected, JP9 and JP11 must be set in accordance to JP8.

COM 2 to COM 4 are fixed at RS232.

The pin functions of COM port 1 will vary according to JP8's, JP9's and JP11's setting. JP14 is used to configure the Serial COM port 1 to pure RS232 or RS232 with power. Refer to "COM 1 RS232/422/485 Select" and "COM 1 RS232/Power Select" in this chapter for more information.

The serial ports are asynchronous communication ports with 16C550A-compatible UARTs that can be used with modems, serial printers, remote display terminals, and other serial devices.

Connecting External Serial Ports

Your COM port may come mounted on a card-edge bracket. Install the card-edge bracket to an available slot at the rear of the system chassis then insert the serial port cable to the COM connector. Make sure the colored stripe on the ribbon cable is aligned with pin 1 of the COM connector.

BIOS Setting

Configure the serial COM ports in the Advanced menu ("Super IO Configuration" submenu) of the BIOS. Refer to the chapter 3 for more information.

LVDS LCD Panel Connector LCD/Inverter Power Connector

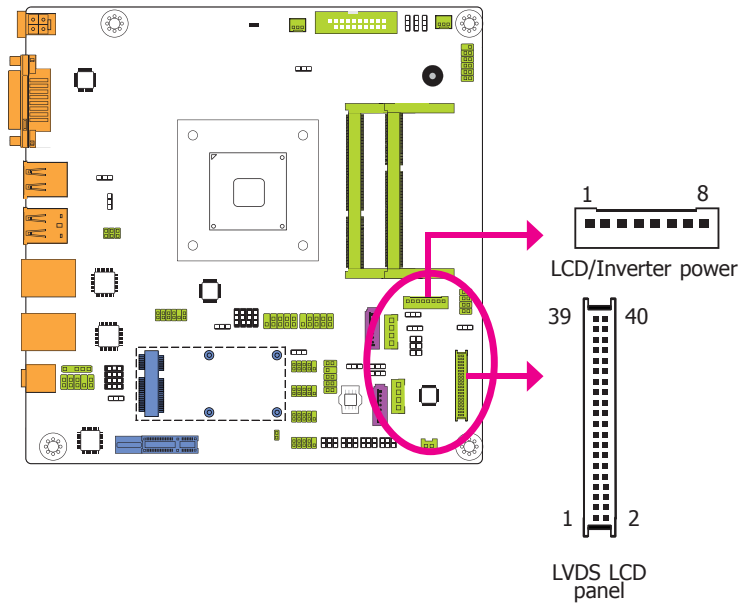

The system board allows you to connect a LCD Display Panel by means of the LVDS LCD panel connectors and the LCD/Inverter power connectors. These connectors transmit video signals and power from the system board to the LCD Display Panel.

Refer to the right side for the pin functions of these connectors.

Jumper Settings

Refer to the "Jumper Settings" section in this chapter for settings relevant to the LCD panel.



Note:

DFI board's LVDS connector: Hirose DF13-40DP-1.25V(91)/40P/1.25mm; cable side connector: Hirose DF13-40DS-1.25C.

LVDS LCD Panel Connector

Pins	Function	Pins	Function
1	GND	2	GND
3	LVDS_Out3+	4	LVDS_Out7+
5	LVDS_Out3-	6	LVDS_Out7-
7	GND	8	GND
9	LVDS_Out2+	10	LVDS_Out6+
11	LVDS_Out2-	12	LVDS_Out6-
13	GND	14	GND
15	LVDS_Out1+	16	LVDS_Out5+
17	LVDS_Out1-	18	LVDS_Out5-
19	GND	20	GND
21	LVDS_Out0+	22	LVDS_Out4+
23	LVDS_Out0-	24	LVDS_Out4-
25	GND	26	GND
27	LVDS_CLK1+	28	LVDS_CLK2+
29	LVDS_CLK1-	30	LVDS_CLK2-
31	GND	32	GND
33	LVDS_DDCCLK	34	N.C.
35	LVDS_DDCDTA	36	+3.3V
37	Panel Power	38	Panel Power
39	Panel Power	40	Panel Power

LCD/Inverter Power Connector

Pins	Function
1	GND
2	GND
3	Panel Inverter Brightness Voltage Control
4	Panel Power
5	+3.3V
6	Panel Backlight On/Off Control
7	LCD/Inverter Power
8	LCD/Inverter Power

PS/2 Keyboard/Mouse Connector

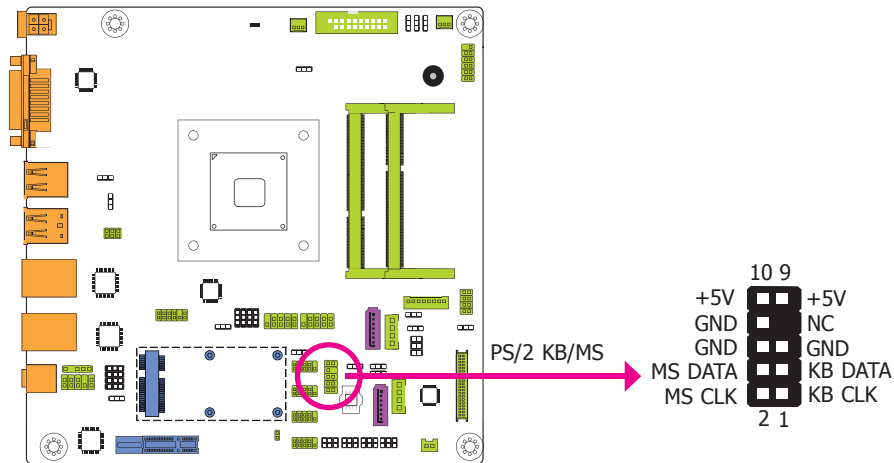

Wake-On-PS/2 Keyboard/Mouse

The Wake-On-PS/2 Keyboard/Mouse function allows you to use the PS/2 keyboard or PS/2 mouse to power-on the system. To use this function:

- **Jumper Setting**

JP6 must be set to "2-3 On: 5V_standby". Refer to "PS/2 Keyboard/Mouse Power Select" in this chapter for more information.



Important:

The 5V_standby power source of your power supply must support $\geq 720\text{mA}$.

The Keyboard/Mouse connector is used to connect PS/2 keyboard and PS/2 mouse by means of a PS/2 cable. Connect one end of the cable to the Keyboard/Mouse connector. The other ends are used to connect a PS/2 keyboard and a PS/2 mouse.

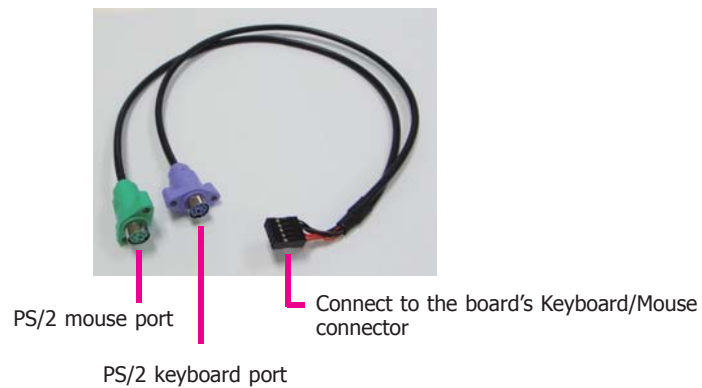

SMBus Connector

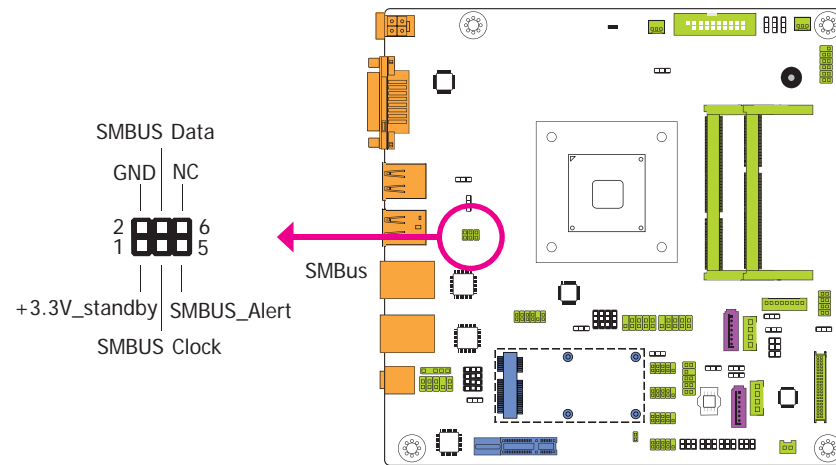

The SMBus (System Management Bus) connector is used to connect SMBus devices. It is a multiple device bus that allows multiple chips to connect to the same bus and enable each one to act as a master by initiating data transfer.

Expansion Slots

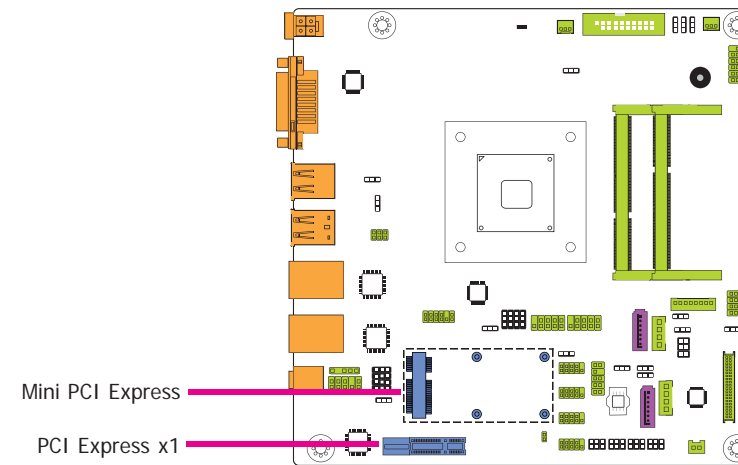

PCI Express x1 Slot

Install PCI Express cards such as network cards or other cards that comply to the PCI Express specifications into the PCI Express x1 slot.

Mini PCI Express Slot

The Mini PCIe socket is used to install a Mini PCIe card. Mini PCIe card is a small form factor PCI card with the same signal protocol, electrical definitions, and configuration definitions as the conventional PCI.

S/PDIF Connector

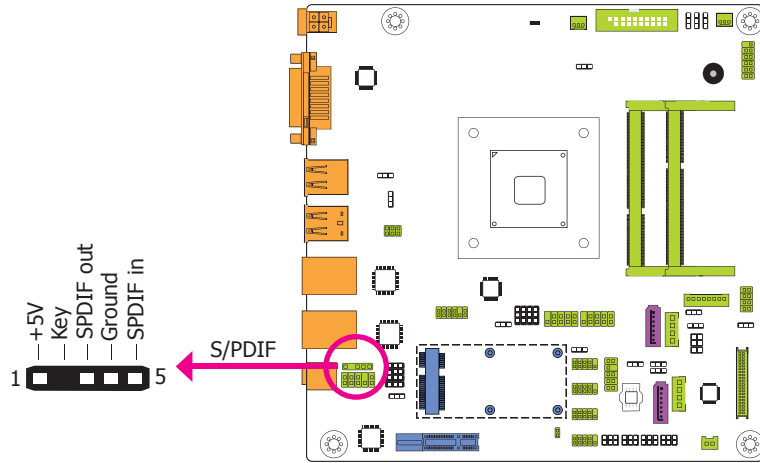

The S/PDIF connector is used to connect an external S/PDIF port. Your S/PDIF port may be mounted on a card-edge bracket. Install the card-edge bracket to an available slot at the rear of the system chassis then connect the audio cable to the S/PDIF connector. Make sure pin 1 of the audio cable is aligned with pin 1 of the S/PDIF connector.

LAN LED Connector

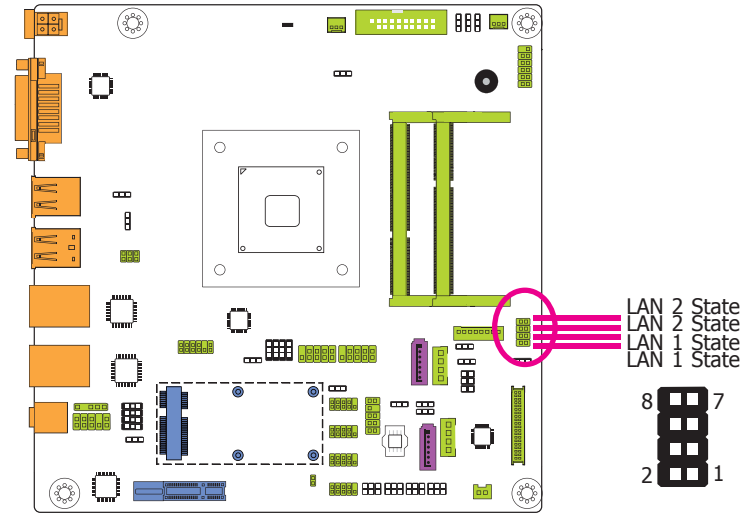

The LAN LED connector is used to detect the connection state of RJ45 LAN ports when the connection is made to an active network via a cable. The pin functions of the LAN LED connector are listed below.

Pins	Pin Assignment	Pins	Pin Assignment
1	LAN0_LED_1000-	2	LAN0_LED_100-
3	LAN0_LED_LINK_ACT-	4	+3.3V_standby
5	LAN1_LED_1000-	6	LAN1_LED_100-
7	LAN1_LED_LINK_ACT-	8	+3.3V_standby

Chassis Intrusion Connector

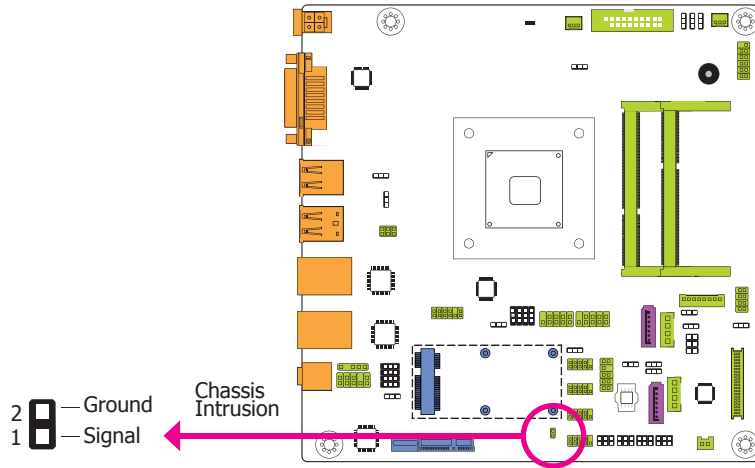

The board supports the chassis intrusion detection function. Connect the chassis intrusion sensor cable from the chassis to this connector. When the system's power is on and a chassis intrusion occurred, an alarm will sound. When the system's power is off and a chassis intrusion occurred, the alarm will sound only when the system restarts.

LPC Connector

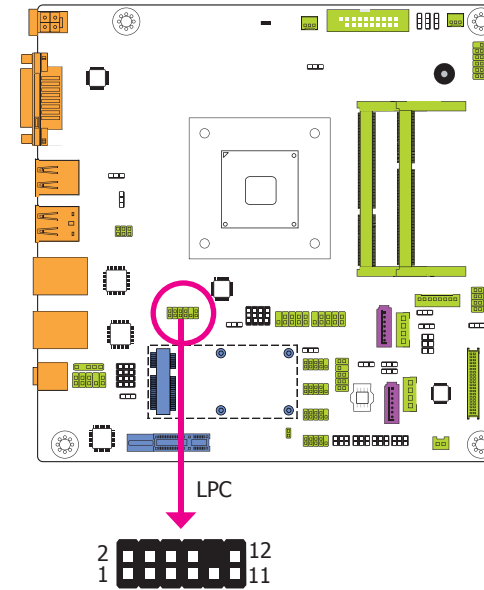

The LPC connector is used for the debug function and its pin functions are listed below.

Pins	Pin Assignment	Pins	Pin Assignment
1	CLK	2	LAD1
3	RST#	4	LAD0
5	FRAME#	6	VCC_+3V
7	LAD3	8	GND
9	LAD2	10	x
11	SERIRQ	12	48MHz

Standby Power LED

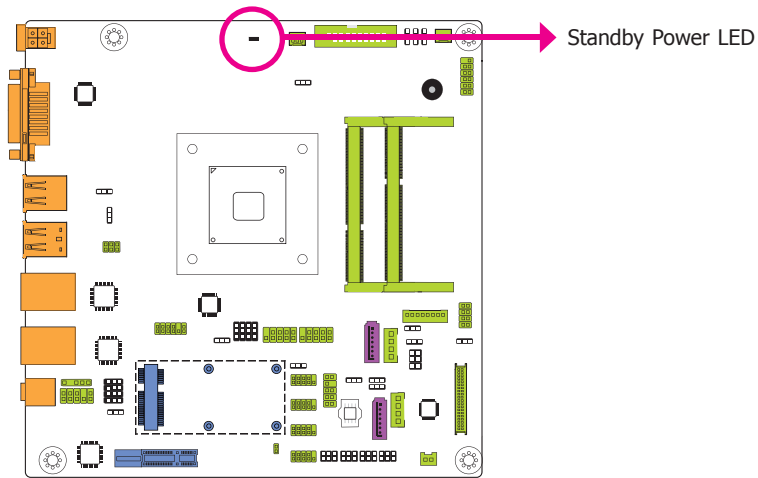

This LED will lit red when the system is in the standby mode. It indicates that there is power on the system board. Power-off the PC and then unplug the power cord prior to installing any devices. Failure to do so will cause severe damage to the motherboard and components.

Battery

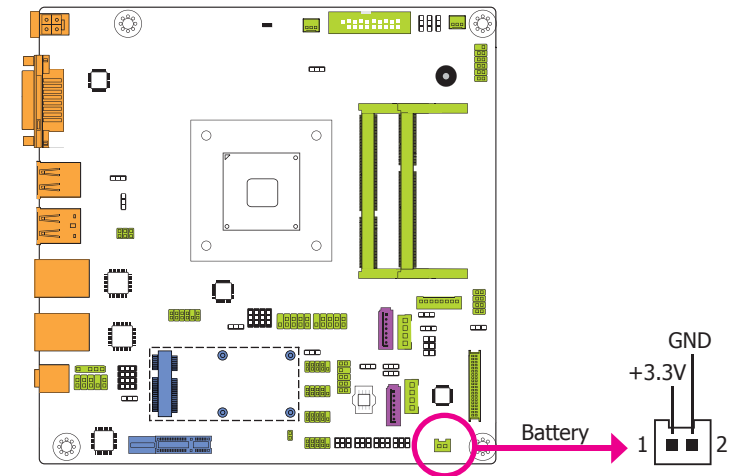

The lithium ion battery powers the real-time clock and CMOS memory. It is an auxiliary source of power when the main power is shut off.

Safety Measures

- Danger of explosion if battery incorrectly replaced.
- Replace only with the same or equivalent type recommend by the manufacturer.
- Dispose of used batteries according to local ordinance.

Chapter 3 - BIOS Setup

Overview

The BIOS is a program that takes care of the basic level of communication between the CPU and peripherals. It contains codes for various advanced features found in this system board. The BIOS allows you to configure the system and save the configuration in a battery-backed CMOS so that the data retains even when the power is off. In general, the information stored in the CMOS RAM of the EEPROM will stay unchanged unless a configuration change has been made such as a hard drive replaced or a device added.

It is possible that the CMOS battery will fail causing CMOS data loss. If this happens, you need to install a new CMOS battery and reconfigure the BIOS settings.



Note:

The BIOS is constantly updated to improve the performance of the system board; therefore the BIOS screens in this chapter may not appear the same as the actual one. These screens are for reference purpose only.

Default Configuration

Most of the configuration settings are either predefined according to the Load Optimal Defaults settings which are stored in the BIOS or are automatically detected and configured without requiring any actions. There are a few settings that you may need to change depending on your system configuration.

Entering the BIOS Setup Utility

The BIOS Setup Utility can only be operated from the keyboard and all commands are keyboard commands. The commands are available at the right side of each setup screen.

The BIOS Setup Utility does not require an operating system to run. After you power up the system, the BIOS message appears on the screen and the memory count begins. After the memory test, the message "Press DEL to run setup" will appear on the screen. If the message disappears before you respond, restart the system or press the "Reset" button. You may also restart the system by pressing the <Ctrl> <Alt> and keys simultaneously.

Legends

Keys	Function
Right and Left arrows	Moves the highlight left or right to select a menu.
Up and Down arrows	Moves the highlight up or down between submenu or fields.
<Esc>	Exit to the BIOS Setup Utility.
+ (plus key)	Scrolls forward through the values or options of the highlighted field.
- (minus key)	Scrolls backward through the values or options of the highlighted field.
Tab	Select a field.
<F1>	Displays general help
<F2>	Previous values
<F3>	Optimized defaults
<F4>	Saves and resets the setup program.
<Enter>	Press <Enter> to enter the highlighted submenu.

Scroll Bar

When a scroll bar appears to the right of the setup screen, it indicates that there are more available fields not shown on the screen. Use the up and down arrow keys to scroll through all the available fields.

Submenu

When "►" appears on the left of a particular field, it indicates that a submenu which contains additional options are available for that field. To display the submenu, move the highlight to that field and press <Enter>.

AMI BIOS Setup Utility

Main

The Main menu is the first screen that you will see when you enter the BIOS Setup Utility.

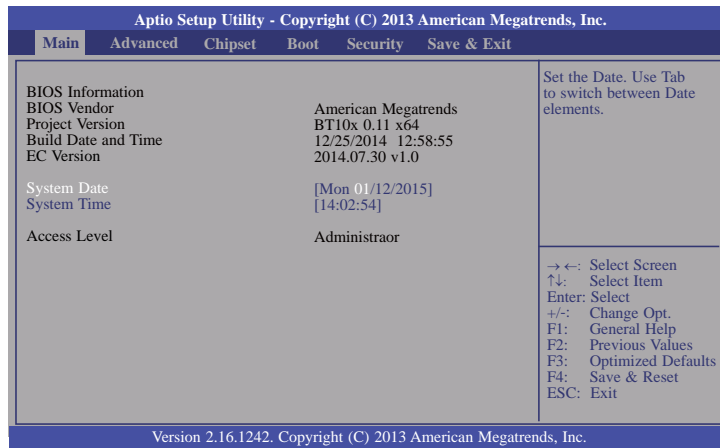

System Date

The date format is <day>, <month>, <date>, <year>. Day displays a day, from Sunday to Saturday. Month displays the month, from January to December. Date displays the date, from 1 to 31. Year displays the year, from 1980 to 2099.

System Time

The time format is <hour>, <minute>, <second>. The time is based on the 24-hour military-time clock. For example, 1 p.m. is 13:00:00. Hour displays hours from 00 to 23. Minute displays minutes from 00 to 59. Second displays seconds from 00 to 59.

Advanced

The Advanced menu allows you to configure your system for basic operation. Some entries are defaults required by the system board, while others, if enabled, will improve the performance of your system or let you set some features according to your preference.



Important:

Setting incorrect field values may cause the system to malfunction.

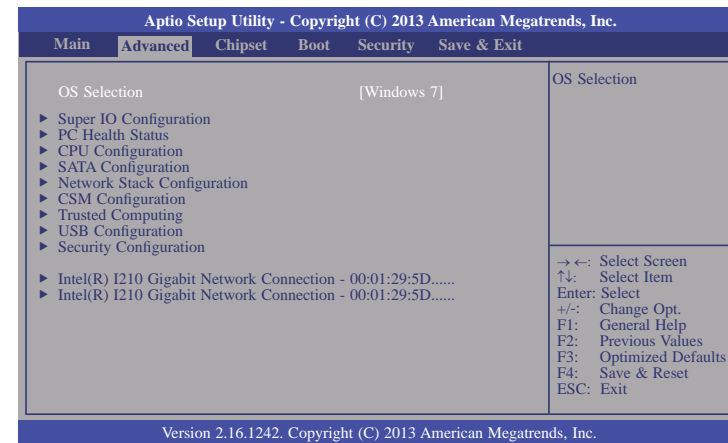

OS Selection

Select the OS support: Windows 7 or Windows 8.X.

Super IO Configuration

This section is used to configure the parameters of the super IO chip.

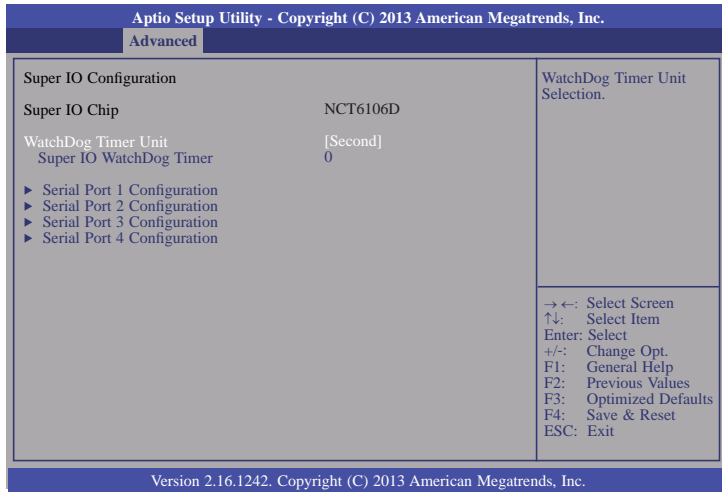

WatchDog Timer Unit

Select the WatchDog Timer Unit: second or minute.

Super IO WatchDog Timer

Enter the value to set the Super IO WatchDog timer. 0 means disabled.

Serial Port 1 Configuration to Serial Port 4 Configuration

Sets the parameters of serial port 1 (COM A) and serial port 4 (COM D).

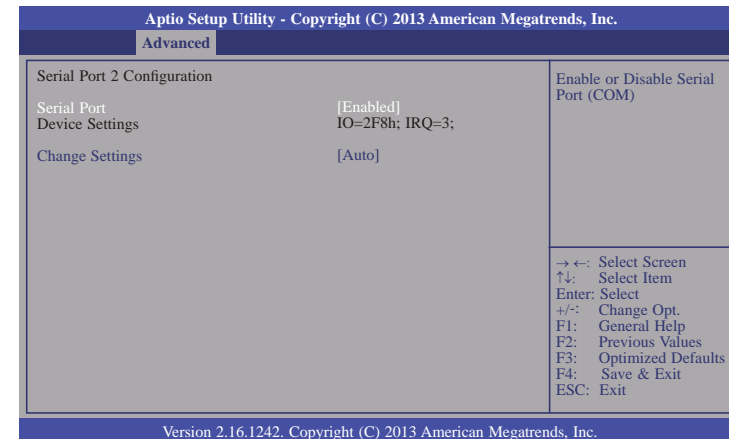
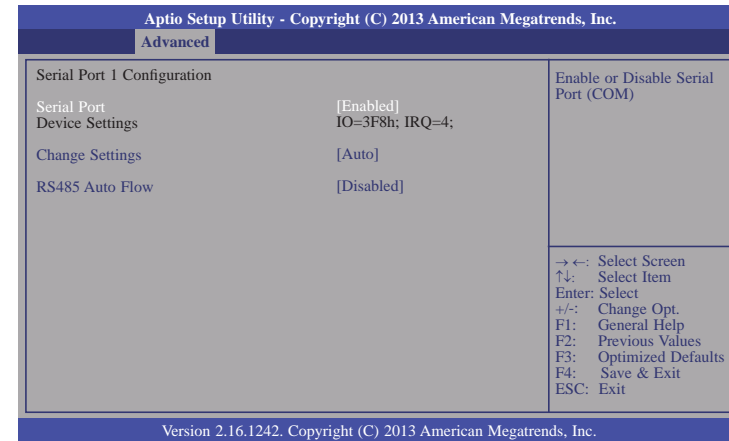

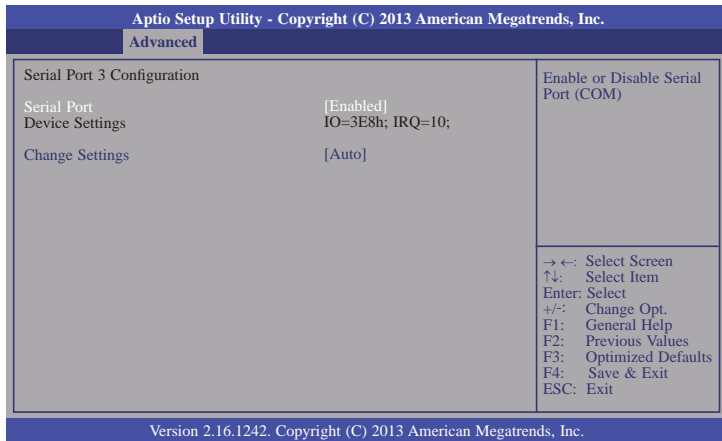

Serial Port

Enable or disable the serial COM port.

Change Settings

Select the IO/IRQ settings for the super I/O device.

RS485 Auto Flow

Set the RS485 auto flow of the serial COM port.

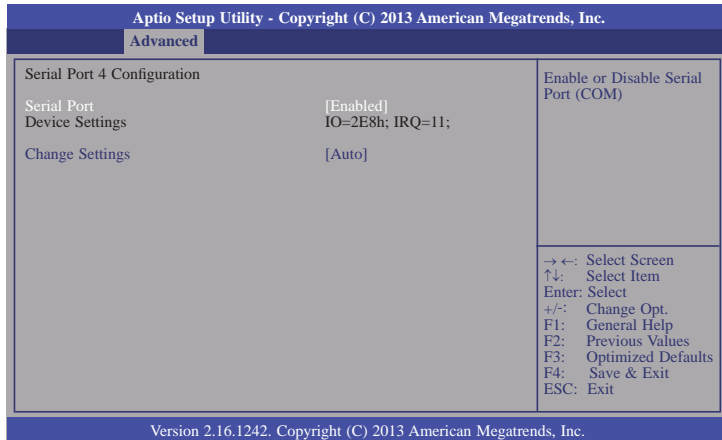

PC Health Status

This section is used to monitor the hardware status.

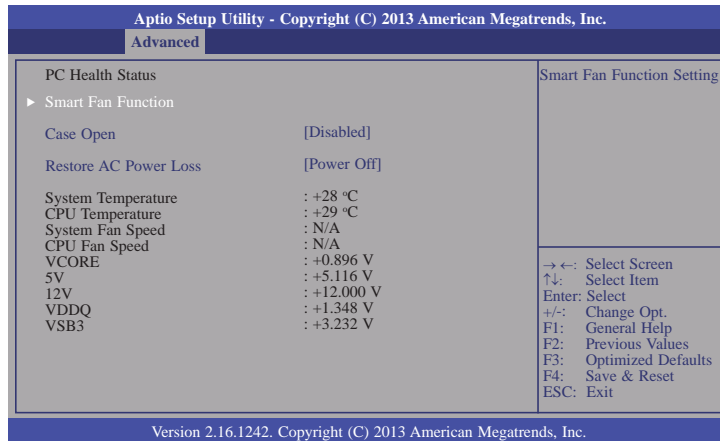

Smart Fan Function

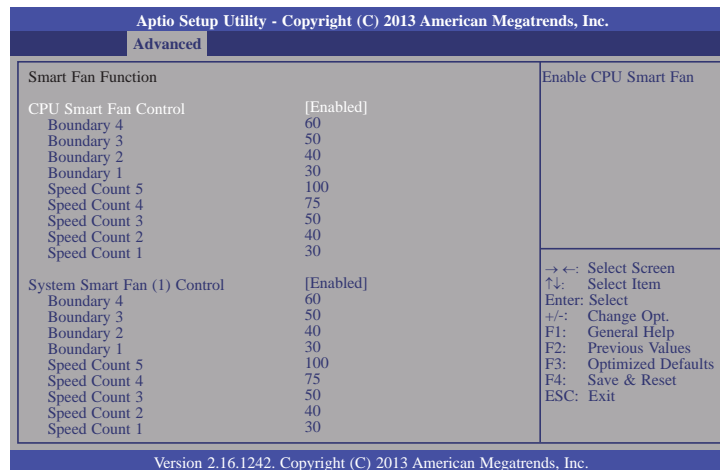

CPU Smart Fan Control

When this feature is set to Automatic, the CPU's fan speed will rotate according to the CPU's temperature. The higher the temperature, the faster the speed of rotation.

System Smart Fan Control

When this feature is set to Automatic, the System's fan speed will rotate according to the System's temperature. The higher the temperature, the faster the speed of rotation.

Boundary 1 to Boundary 4

The range is 0-127.

Speed Count 1 to Speed Count 5

The range is 1-100%.

Case Open

Set this field to Enabled to allow the system to alert you of a chassis intrusion event.

Restore AC Power Loss

Power Off

When power returns after an AC power failure, the system's power is off. You must press the Power button to power-on the system.

Power On

When power returns after an AC power failure, the system will automatically power-on.

Last State

When power returns after an AC power failure, the system will return to the state where you left off before power failure occurs. If the system's power is off when AC power failure occurs, it will remain off when power returns. If the system's power is on when AC power failure occurs, the system will power-on when power returns.

CPU Configuration

This section is used to configure the CPU. It will also display the detected CPU information.

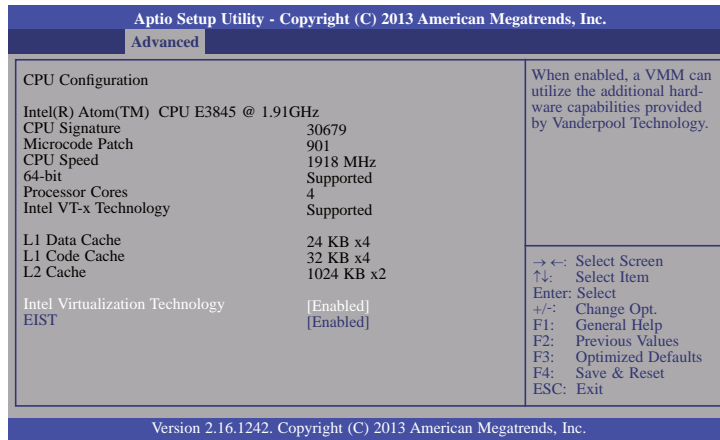

Intel Virtualization Technology

When this field is set to Enabled, the VMM can utilize the additional hardware capabilities provided by Vanderpool Technology.

EIST

This field is used to enable or disable the Intel Enhanced SpeedStep Technology.

SATA Configuration

This section is used to enable or disable SATA devices.

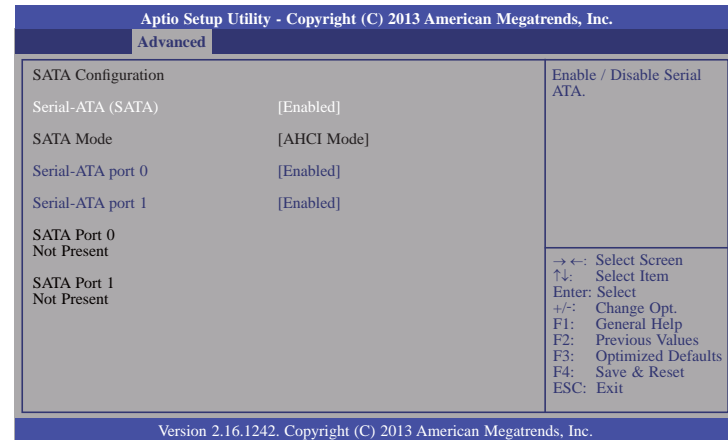

Serial-ATA (SATA)

This field is used to enable or disable Serial ATA devices.

Serial-ATA port 0 and port 1

Enable or disable Serial ATA port 0 and port 1.

Network Stack Configuration

This section is used to enable or disable network stack settings.

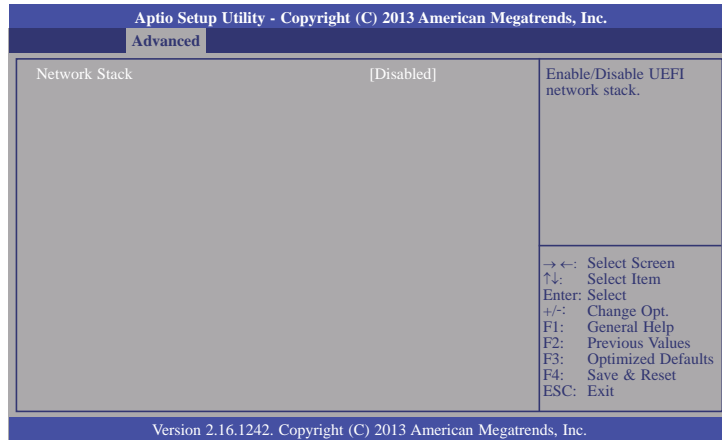

When Network Stack is set to enabled, it will display the following information:

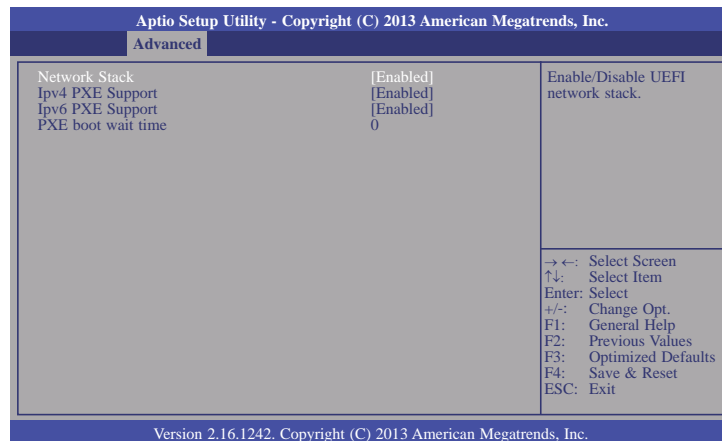

Ipv4 PXE Support

When enabled, Ipv4 PXE boot supports. When disabled, Ipv4 PXE boot option will not be created.

Ipv6 PXE Support

When enabled, Ipv6 PXE boot supports. When disabled, Ipv6 PXE boot option will not be created.

PXE boot wait time

Enter the wait time value to abort the PXE boot.

CSM Configuration

This section configures the CSM settings.

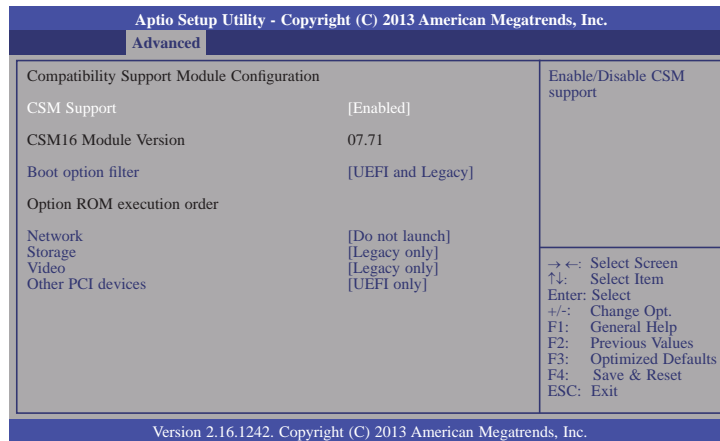

CSM Support

This field is used to enable or disable the CSM support.

Boot option filter

This option controls Legacy/UEFI ROMs priority.

Network

This field controls the execution of UEFI and Legacy PXE OpROM.

Storage

This field controls the execution of UEFI and Legacy Storage OpROM.

Video

This field controls the execution of UEFI and Legacy Video OpROM.

Other PCI devices

This field determines OpROM execution policy for devices other than network, storage or video.

Trusted Computing

This section configures settings relevant to Trusted Computing innovations.

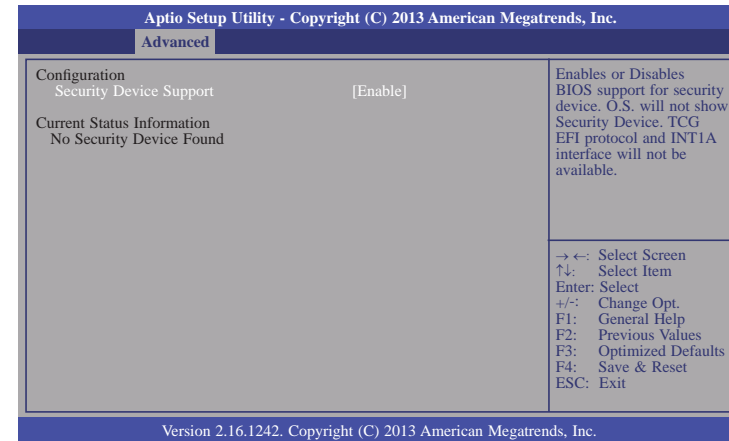

Security Device Support

This field is used to enable or disable BIOS supporting for the security device. O.S will not show the security device. TCG EFI protocol and INT1A interface will not be available.

USB Configuration

This section is used to configure the parameters of USB device.

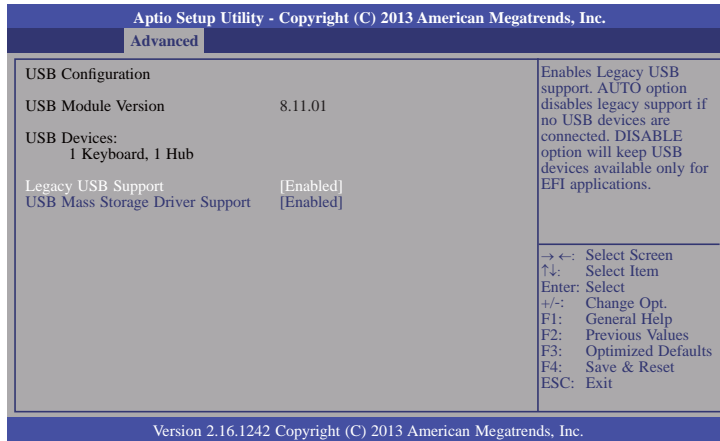

Legacy USB Support

Enabled

Enable legacy USB.

Disabled

Keep USB devices available only for EFI applications.

Auto

Disable support for legacy when no USB devices are connected.

USB Mass Storage Driver Support

Enable or disable the support of the USB Mass Storage Driver.



Important:

When installing Windows 7, only native USB 2.0 devices (USB port 0 to USB port 3) can operate under DOS mode. Please refer to the following tables for more information on the type of USB ports.

Table 1. OS Selection

Operation Environment for Customers	DOS	Windows 7	Windows 8.x	Linux
OS Selection in the BIOS Advanced Menu	Windows 8.x	Windows 7	Windows 8.x	Windows 8.x
Available USB ports	All	When installing Windows 7 first time, only native USB 2.0 ports can work. Please refer to the USB type in table 2 below.	All	All

Table 2. The Type of USB Ports

Model Name	BT101/BT103
USB 3.0	Native
USB 0	Native
USB 1	Native
USB 2	Native (share with USB 3.0 port)
USB 3	Native
USB 4	HSIC port 0
USB 5	HSIC port 1
USB 6	HSIC port 2
USB 7	HSIC port 3

Security Configuration

This section only displays the setting relevant to the Intel(R) Anti-Theft Technology.

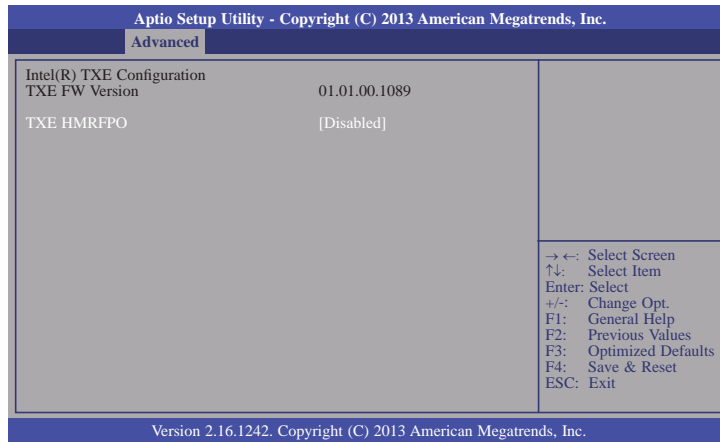

Intel(R) I210 Gigabit Network Connection - 00:01:29:5D...

This section is used to configure the parameters of Gigabit Ethernet device.

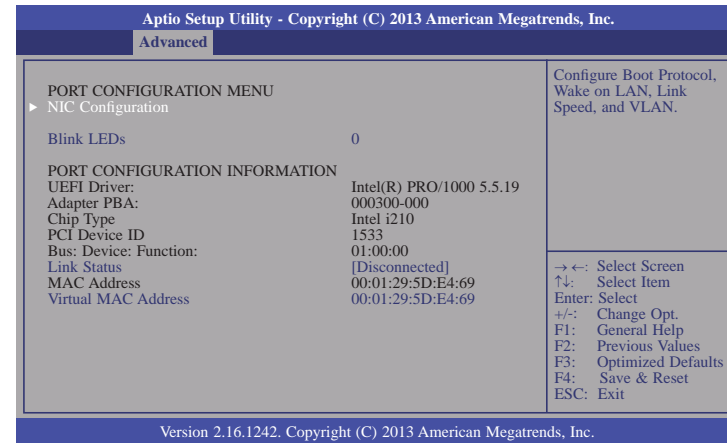

Blink LEDs

Identify the physical network port by blinking the associated LED.

Link Status

This field indicates the link status of the network device.

Virtual MAC Address

This field indicates programmatically assignable MAC address for the network port.

NIC Configuration

This field is used to configure the network device.

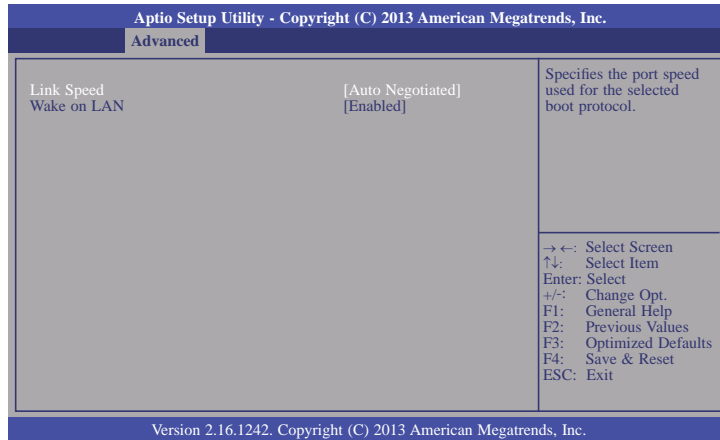

Link Speed

Specify the port speed which is used for the selected boot protocol.

Wake on LAN

Enables the server to be powered on using an in-band magic packet.

Intel(R) I210 Gigabit Network Connection - 00:01:29:5D...

This section is used to configure the parameters of Gigabit Ethernet device.

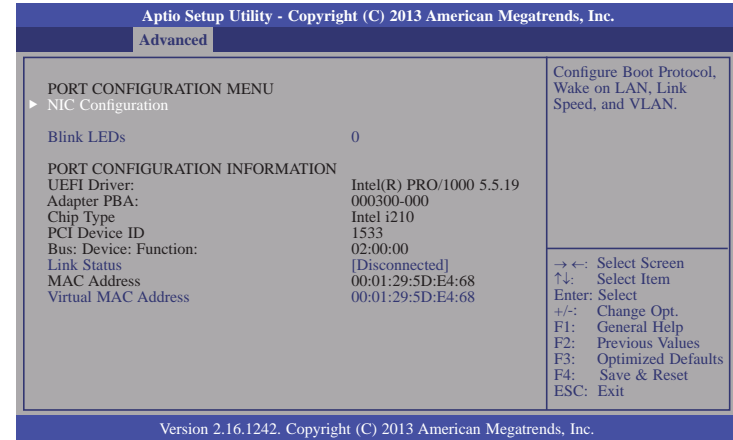

Blink LEDs

Identify the physical network port by blinking the associated LED.

Link Status

This field indicates the link status of the network device.

Virtual MAC Address

This field indicates programmatically assignable MAC address for the network port.

NIC Configuration

This field is used to configure the network device.

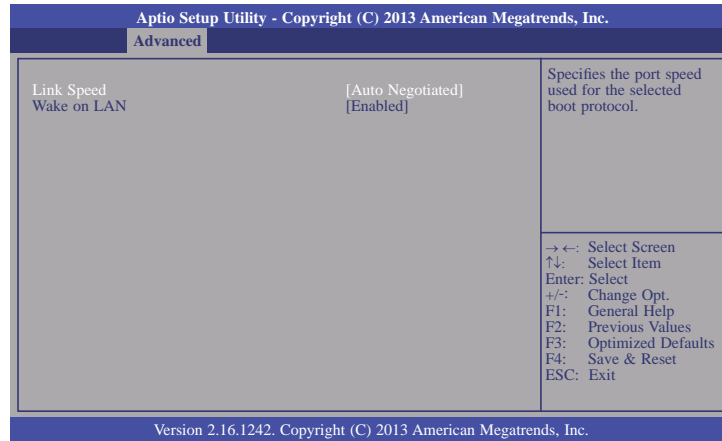

Link Speed

Specify the port speed which is used for the selected boot protocol.

Wake on LAN

Enables the server to be powered on using an in-band magic packet.

Chipset

This section configures relevant chipset functions.

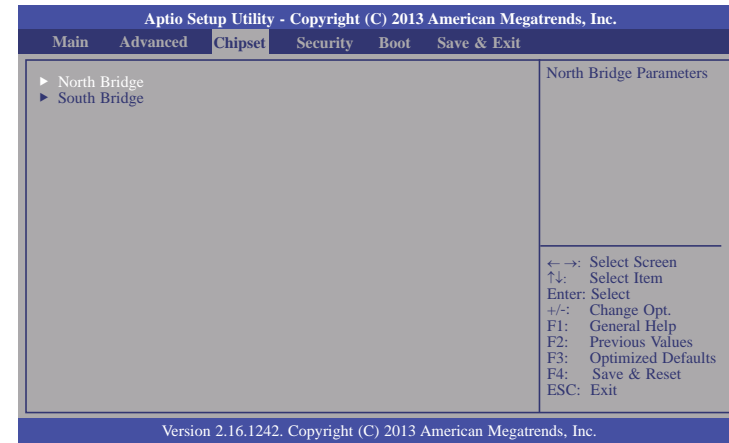

North Bridge

This section configures the North bridge parameters.

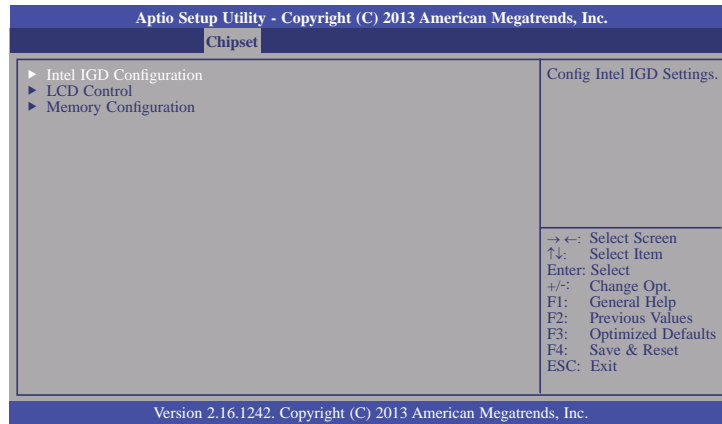

Intel IGD Configuration

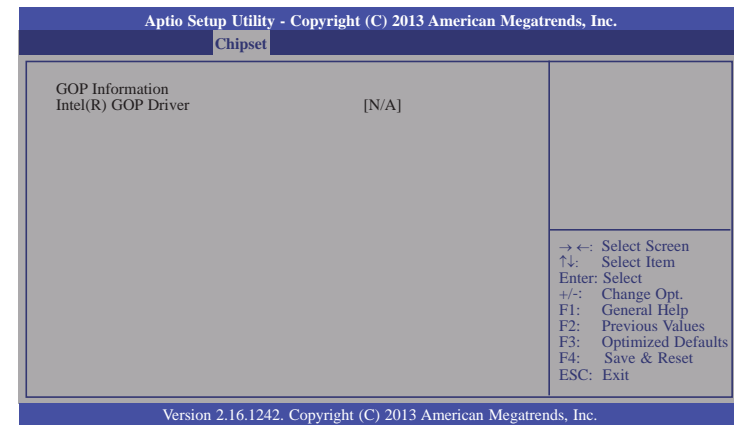

LCD Control

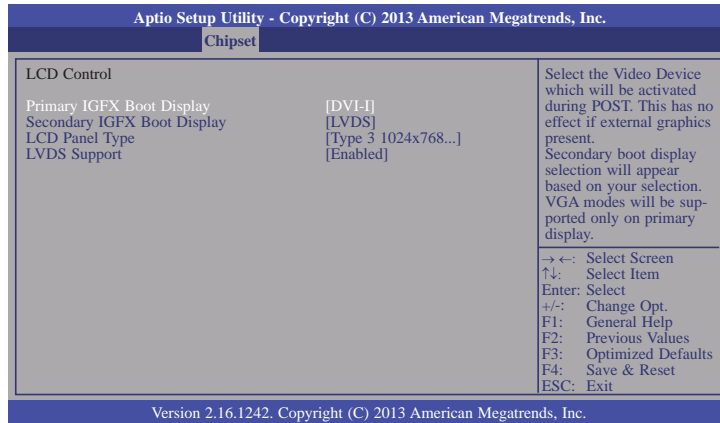

Primary IGFX Boot Display

Select the Video Device which will be activated during POST. This has no effect if the external graphics presents. The selection of secondary boot display will appear based on your selection. VGA modes will be supported only on primary display.

Secondary IGFX Boot Display

Select the secondary display device: LVDS or DVI-I. LVDS is the default setting.

LCD Panel Type

Select the LCD panel used by Internal Graphics Device by selecting the appropriate setup item. Please refer to the screen shown below.

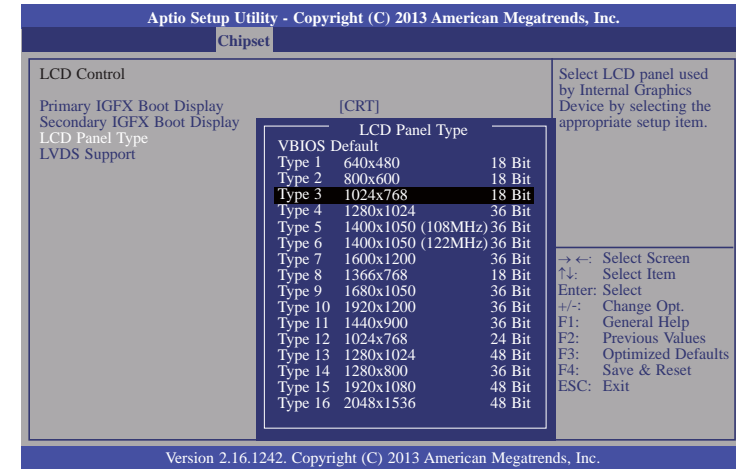

LVDS Support

Enable or disable the onboard LVDS function.

Memory Configuration

This section only displays the parameter of memory configuration.

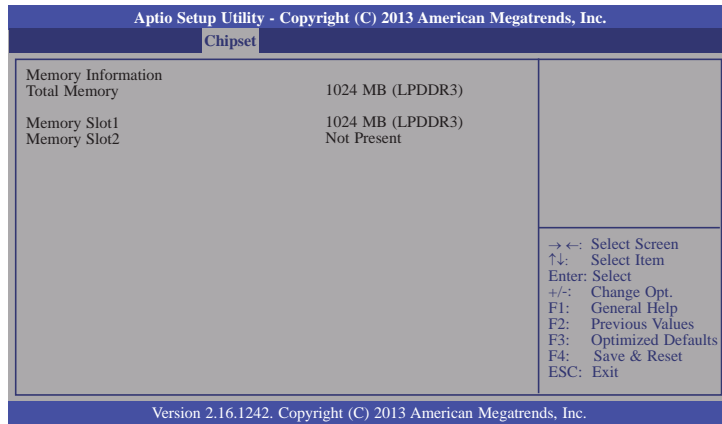

South Bridge

This field is used to configure the parameters of the South Bridge.

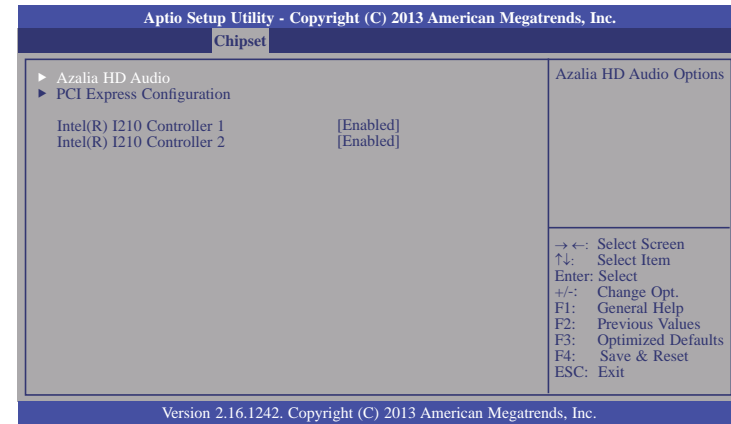

Intel(R) I210 Controller 1 and 2

Enable the Intel(R) I210 ethernet controller.

Azalia HD Audio

This section configures Azalia HD Audio options.

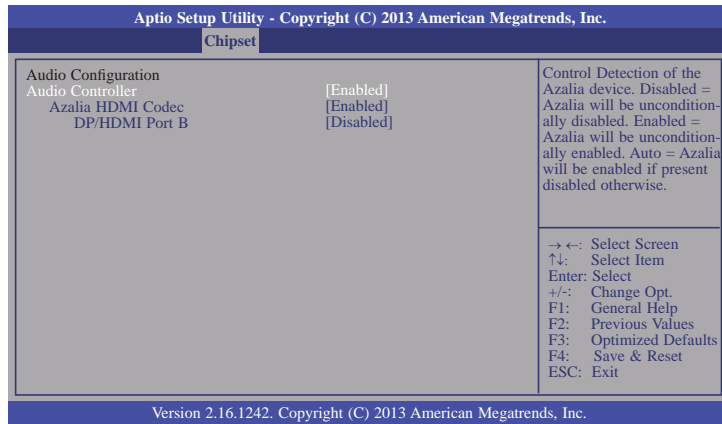

Audio Controller

This item controls the detection of the Azalia device.

Disabled

Azalia will be unconditionally disabled.

Enabled

Azalia will be unconditionally enabled.

Auto

Azalia will be enabled automatically.

Azalia HDMI Codec

Enable or disable the internal HDMI codec for Azalia.

DP/HDMI Port B

Enable or disable the DP/HDMI Port B.

PCI Express Configuration

This section configures settings relevant to PCI Express devices.

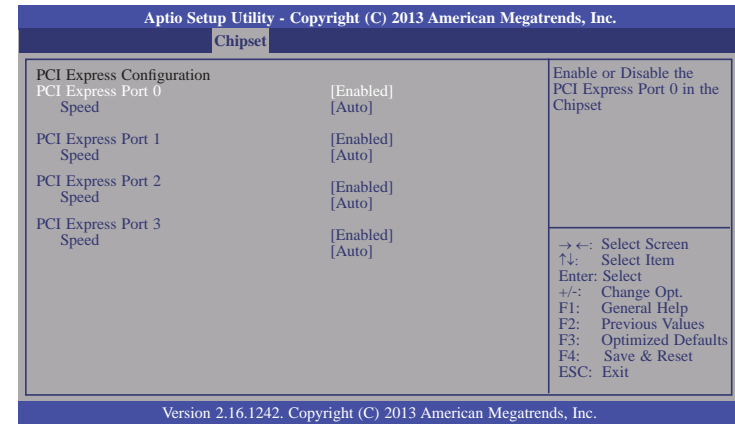

PCI Express Port 0-3

Enable or disable the PCI Express port in the chipset.

Speed

Select the speed for the PCI Express devices. The option is Auto, Gen1 or Gen2.

Security

Aptio Setup Utility - Copyright (C) 2013 American Megatrends, Inc.					
Main	Advanced	Chipset	Security	Boot	Save & Exit
Password Description If ONLY the Administrator's password is set, then this only limits access to Setup and is only asked for when entering Setup. If ONLY the User's password is set, then this is a power on password and must be entered to boot or enter Setup. In Setup the User will have Administrator rights. The password length must be in the following range: Minimum length 3 Maximum length 20 Administrator Password User Password		Set Administrator Password. → ←: Select Screen ↑ ↓: Select Item Enter: Select +/-: Change Opt. F1: General Help F2: Previous Values F3: Optimized Defaults F4: Save & Reset ESC: Exit			
Version 2.16.1242. Copyright (C) 2013 American Megatrends, Inc.					

Administrator Password

Set the administrator password.

User Password

Set the user password.

Boot

Aptio Setup Utility - Copyright (C) 2013 American Megatrends, Inc.					
Main	Advanced	Chipset	Security	Boot	Save & Exit
Boot Configuration Setup Prompt Timeout 1 Bootup NumLock State [On] Boot Option Priorities		Number of seconds to wait for setup activation key. 65535(0xFFFF) means indefinite waiting.			
		← →: Select Screen ↑ ↓: Select Item Enter: Select +/-: Change Opt. F1: General Help F2: Previous Values F3: Optimized Defaults F4: Save & Reset ESC: Exit			
Version 2.16.1242. Copyright (C) 2013 American Megatrends, Inc.					

Setup Prompt Timeout

Select the number of seconds to wait for the setup activation key. 65535(0xFFFF) denotes indefinite waiting.

Bootup NumLock State

This allows you to determine the default state of the numeric keypad. By default, the system boots up with NumLock on wherein the function of the numeric keypad is the number keys. When set to Off, the function of the numeric keypad is the arrow keys.

Save & Exit

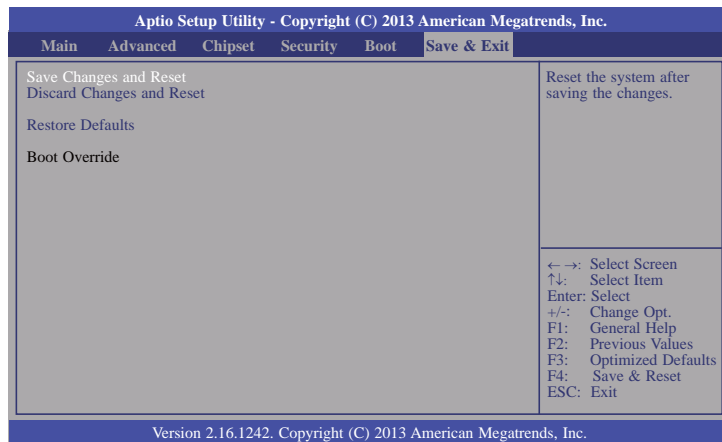

Save Changes and Reset

To save the changes, select this field and then press <Enter>. A dialog box will appear. Select Yes to reset the system after saving all changes made.

Discard Changes and Reset

To discard the changes, select this field and then press <Enter>. A dialog box will appear. Select Yes to reset the system setup without saving any changes.

Restore Defaults

To restore and load the optimized default values, select this field and then press <Enter>. A dialog box will appear. Select Yes to restore the default values of all the setup options.

Updating the BIOS

To update the BIOS, you will need the new BIOS file and a flash utility, AFUDOS.EXE. Please contact technical support or your sales representative for the files.

To execute the utility, type:

```
A:> AFUDOS BIOS_File_Name /b /p /n
```

then press <Enter>.

```
C:\AFU\AFUDOS>afudos filename /B /P /N
AMI Firmware Update Utility(APTIO) v2.25
Copyright (C)2008 American Megatrends Inc. All Rights Reserved.
Reading file ..... done
Erasing flash ..... done
Writing flash ..... done
Verifying flash ..... done
Erasing BootBlock ..... done
Writing BootBlock ..... done
Verifying BootBlock ..... done
C:\AFU\AFUDOS>
```

Notice: BIOS SPI ROM

1. The Intel® Management Engine has already been integrated into this system board. Due to the safety concerns, the BIOS (SPI ROM) chip cannot be removed from this system board and used on another system board of the same model.
2. The BIOS (SPI ROM) on this system board must be the original equipment from the factory and cannot be used to replace one which has been utilized on other system boards.
3. If you do not follow the methods above, the Intel® Management Engine will not be updated and will cease to be effective.

**Note:**

- a. You can take advantage of flash tools to update the default configuration of the BIOS (SPI ROM) to the latest version anytime.
- b. When the BIOS IC needs to be replaced, you have to populate it properly onto the system board after the EEPROM programmer has been burned and follow the technical person's instructions to confirm that the MAC address should be burned or not.

Chapter 4 - Supported Software

Install drivers, utilities and software applications that are required to facilitate and enhance the performance of the system board. You may acquire the software from your sales representatives, from an optional DVD included in the shipment, or from the website download page at <https://www.dfi.com/DownloadCenter>.

For Windows 8.x

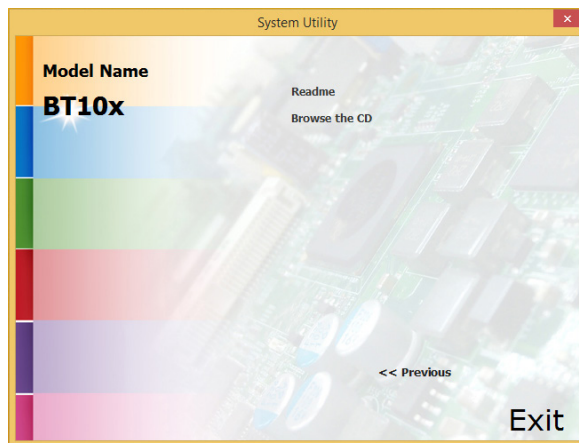
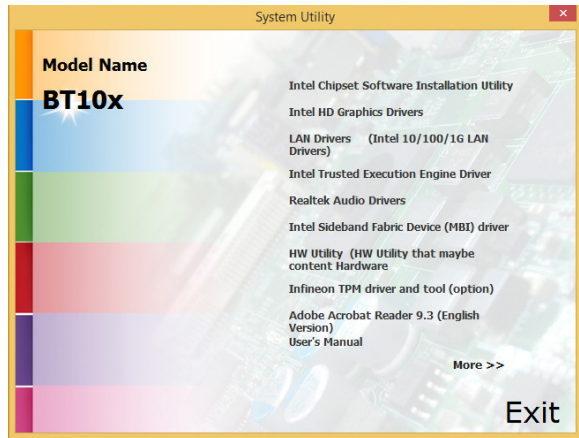

For Windows 7

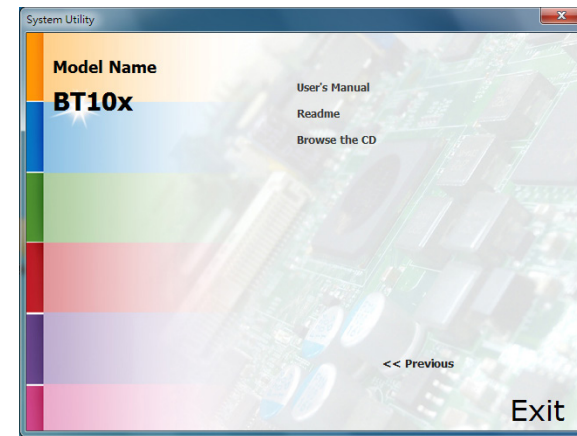
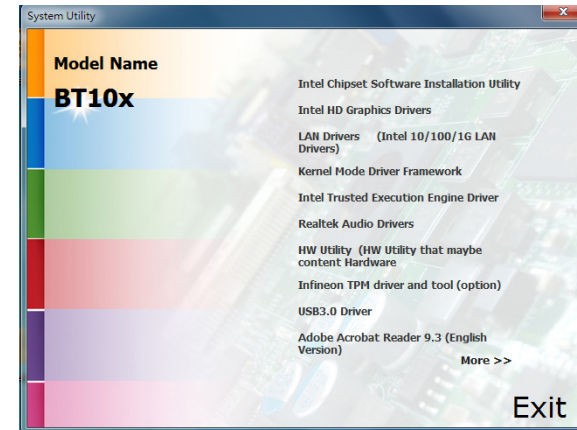

Note:

This step can be ignored if the applications are standalone files.

Intel Chipset Software Installation Utility

The Intel Chipset Device Software is used for updating Windows® INF files so that the Intel chipset can be recognized and configured properly in the system.

To install the utility, click “Intel Chipset Software Installation Utility” on the main menu.

1. Setup is ready to install the utility. Click Next.



2. Read the license agreement then click Yes.



3. Go through the readme document for more installation tips then click Next.



4. After all setup operations are done, click Next.

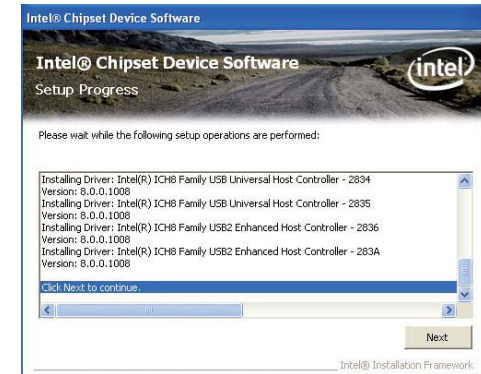

5. Click “Yes, I want to restart this computer now” then click Finish.

Restarting the system will allow the new software installation to take effect.



Intel HD Graphics Drivers

To install the driver, click “Intel HD Graphics Drivers” on the main menu.

1. Setup is now ready to install the graphics driver. Click Next.

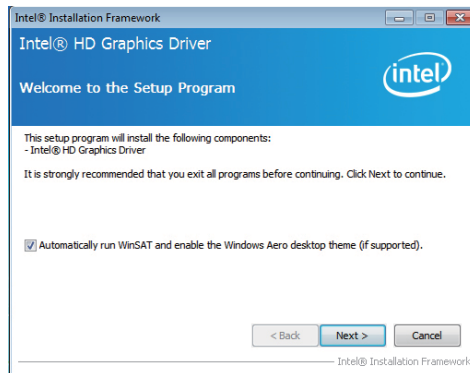

By default, the “Automatically run WinSAT and enable the Windows Aero desktop theme” is enabled. With this enabled, after installing the graphics driver and the system rebooted, the screen will turn blank for 1 to 2 minutes (while WinSAT is running) before the Windows 7/Windows 8 desktop appears. The “blank screen” period is the time Windows is testing the graphics performance.

We recommend that you skip this process by disabling this function then click Next.

2. Read the license agreement then click Yes.



3. Go through the readme document for system requirements and installation tips then click Next.

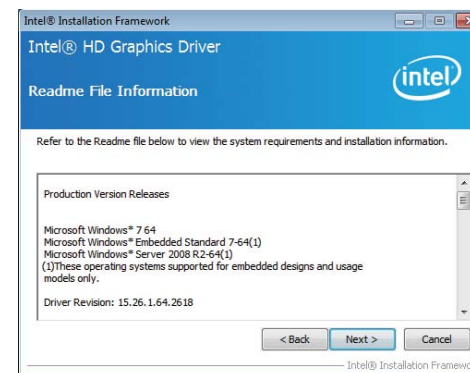

4. Setup is now installing the driver. Click Next to continue.

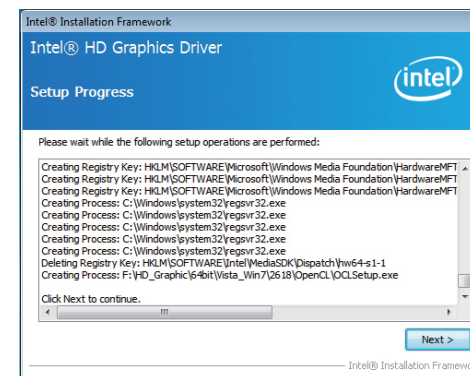

5. Click “Yes, I want to restart this computer now” then click Finish.

Restarting the system will allow the new software installation to take effect.

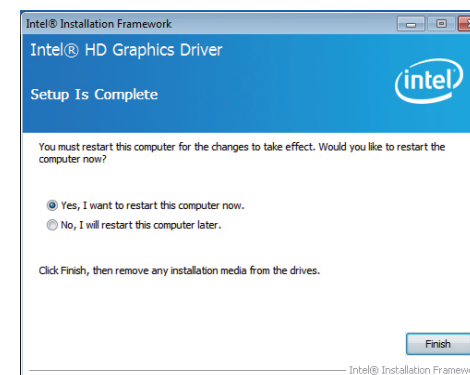

Intel LAN Drivers

To install the driver, click “Intel LAN Drivers” on the main menu.

1. Setup is ready to install the driver. Click Next.



2. Click “I accept the terms in the license agreement” then click “Next”.

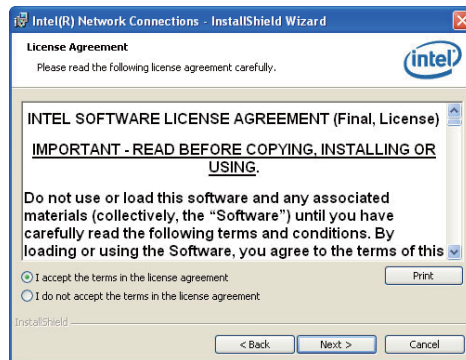

3. Select the program features you want installed then click Next.

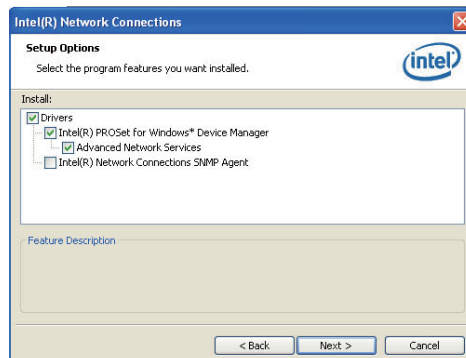

4. Click Install to begin the installation.

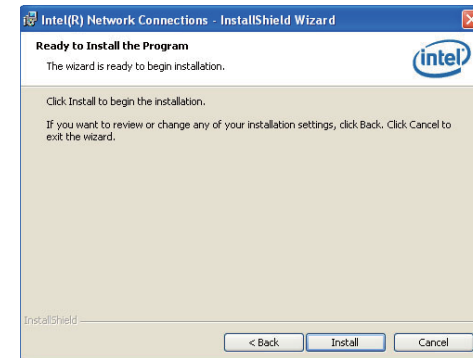

5. After completing installation, click Finish.

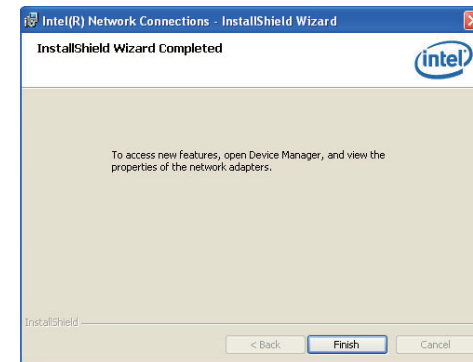

Kernel Mode Driver Framework (For Windows 7 only)

To install the driver, click “Kernel Mode Driver Framework” on the main menu.

1. Click “Yes” to install the update.

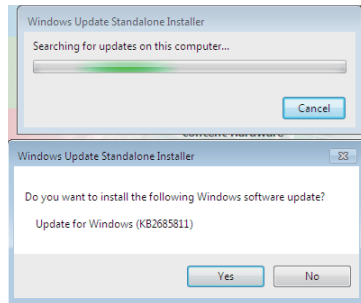

2. The update is installed now.

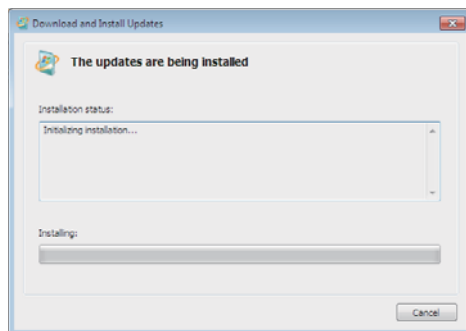

3. Click “Restart Now” to restart your computer when the installation is complete.

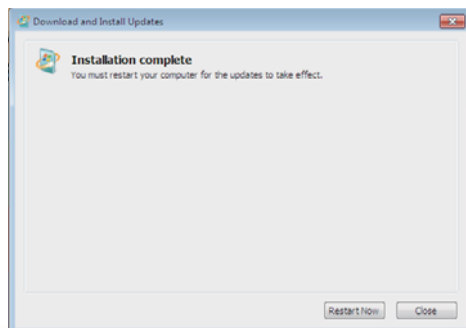

Intel Trusted Execution Engine Driver

To install the driver, click “Intel Trusted Execution Engine Driver” on the main menu.

1. Tick “I accept the terms in the License Agreement” and then click “Next.”

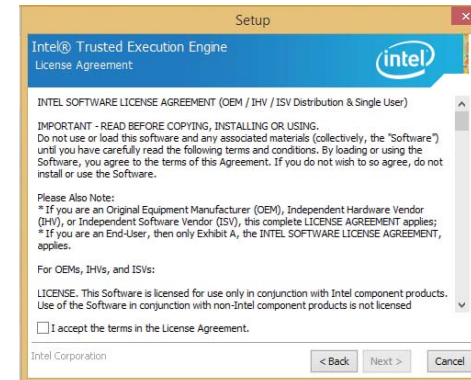

2. The step shows the components which will be installed. Then, Click Next.

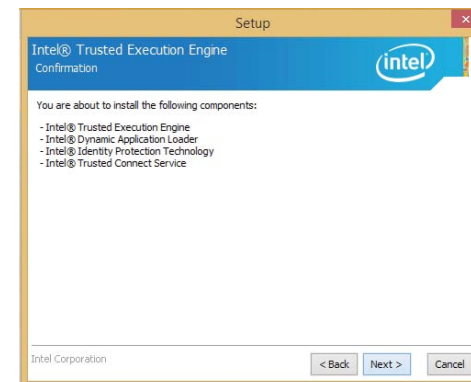

3. The step displays the installing status in the progress.

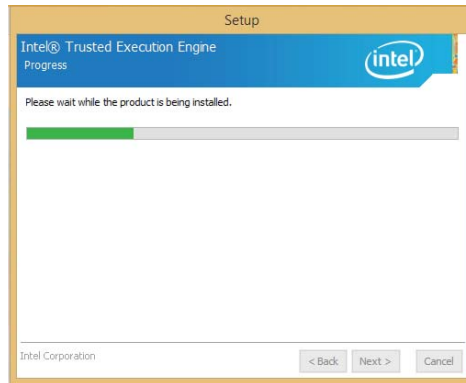

4. Click "Finish" when the installation is complete.

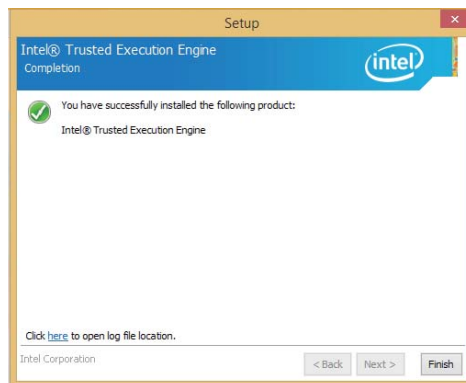

Realtek Audio Drivers

To install the driver, click "Realtek Audio Drivers" on the main menu.

1. Setup is now ready to install the audio driver. Click Next.
2. Follow the remainder of the steps on the screen; clicking "Next" each time you finish a step.

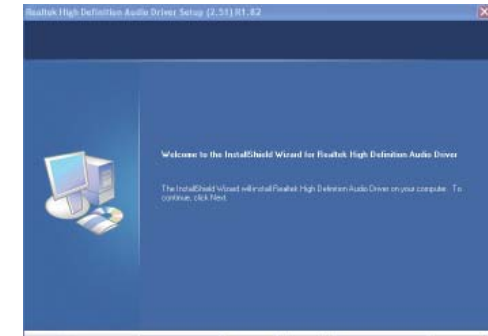

3. Click "Yes, I want to restart my computer now" then click Finish.

Restarting the system will allow the new software installation to take effect.

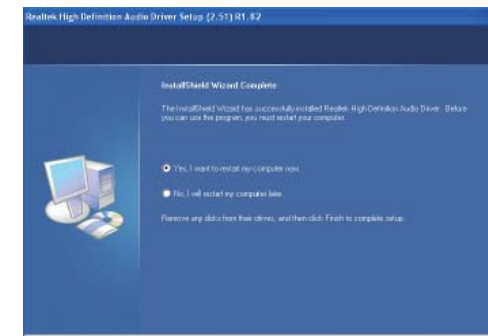

Intel Sideband Fabric Device (MBI) Driver (For Windows 8 only)

To install the driver, click “Intel Sideband Fabric Device (MBI) Driver” on the main menu.

1. The setup program will be installed. Click “Next” to continue.

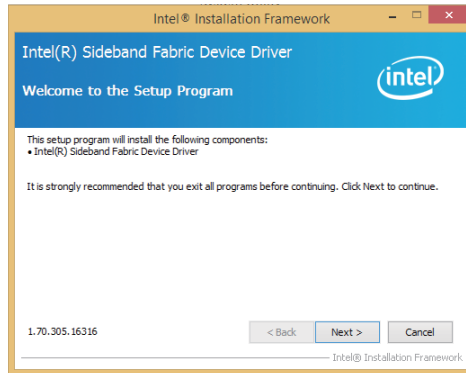

2. Click “Yes” to accept the License Agreement.

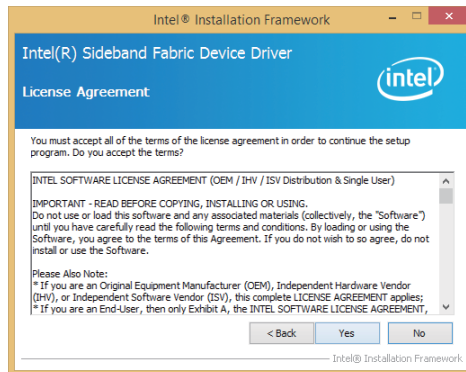

3. The step performs setup operations. Click “Next” to continue.

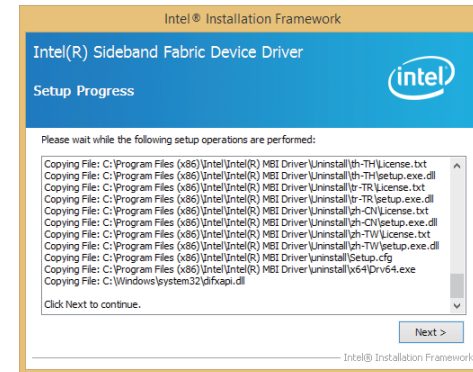

4. Click “Finish” to restart the computer when the setup is completely installed.

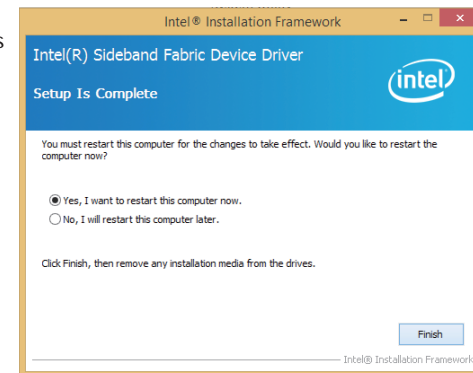

HW Utility

HW Utility provides information about the board, HW Health, Watchdog, DIO, and Backlight. To access the utility, click “HW Utility” on the main menu.



Note:

If you are using Windows 7, you need to access the operating system as an administrator to be able to install the utility.

1. Setup is ready to install the HW Utility driver. Click Next.

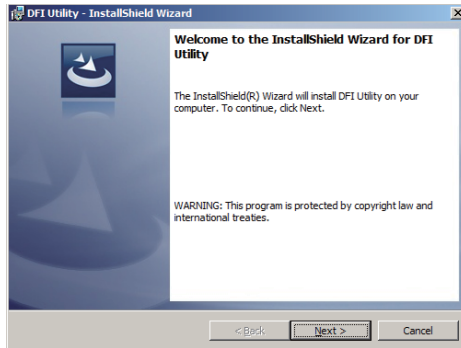

2. Click “I accept the terms in the license agreement” and then click Next.

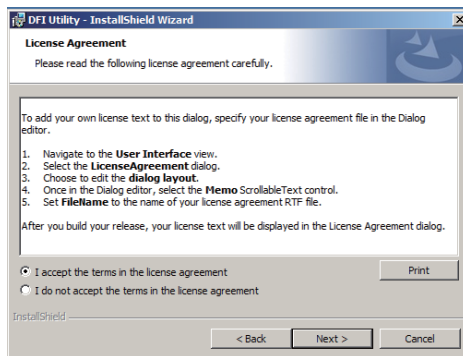

3. Enter “User Name” and “Organization” information and then click Next.

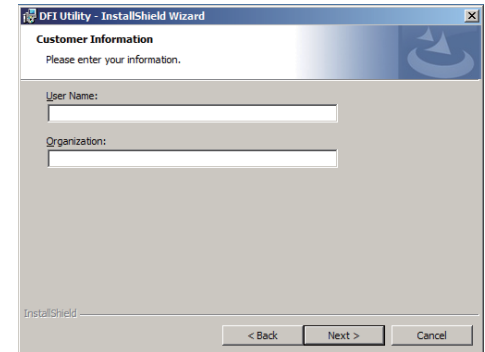

4. Click Install to begin the installation.

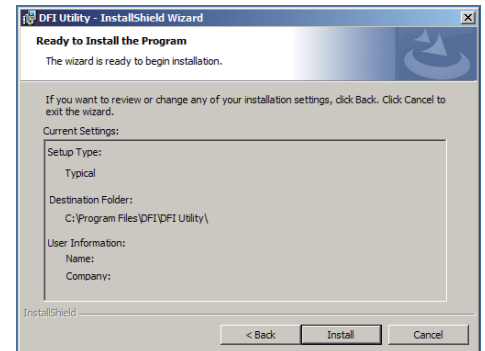

5. After completing installation, click Finish.

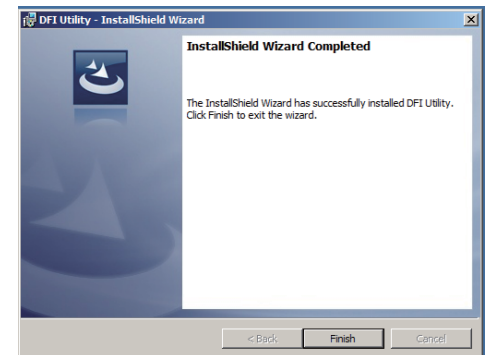

The HW Utility icon will appear on the desktop. Double-click the icon to open the utility.

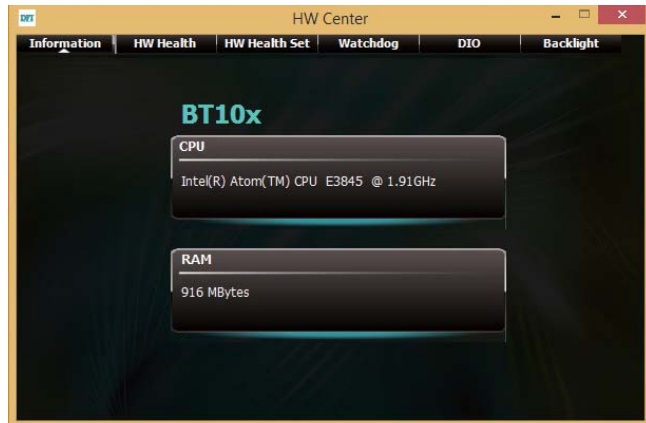

Information



HW Health Set



HW Health



WatchDog



DIO

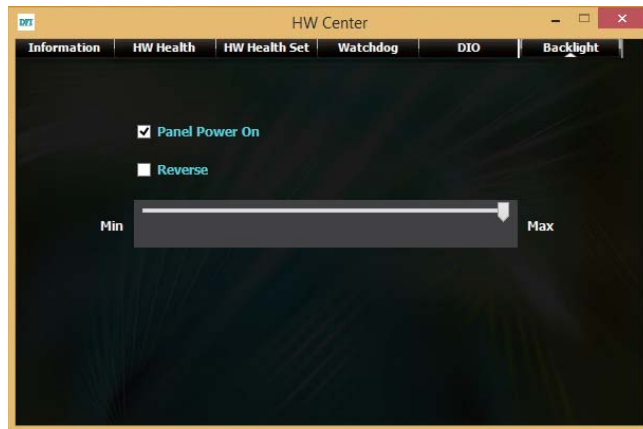

Backlight

Infineon TPM Driver and Tool (option)

To install the driver, click “Infineon TPM driver and tool (option)” on the main menu.

1. The setup program is preparing to install the driver.

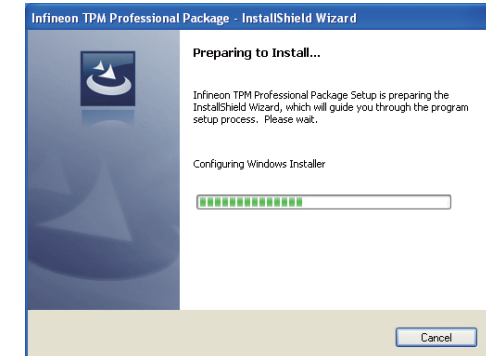

2. The setup program is now ready to install the utility. Click Next.

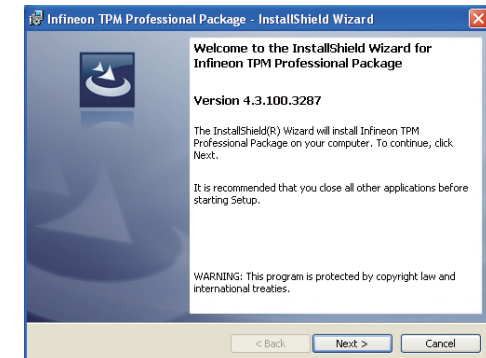

3. Click “I accept the terms in the license agreement” and then click “Next”.

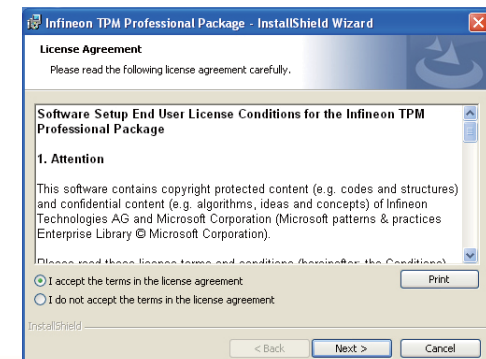

4. Enter the necessary information and then click Next.

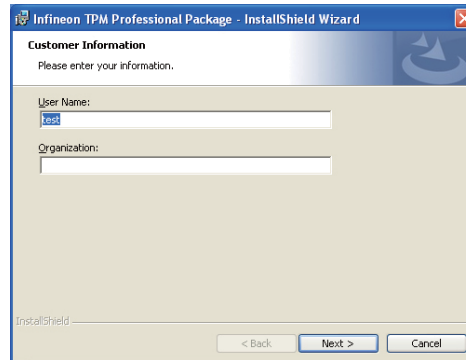

5. Select a setup type and then click Next.

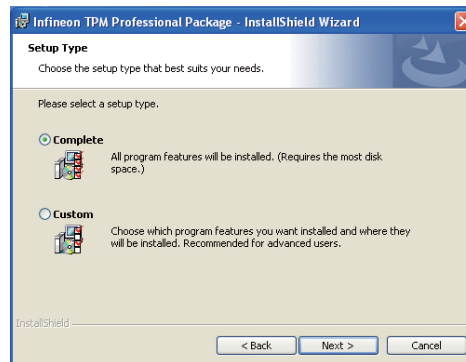

6. Click Install.

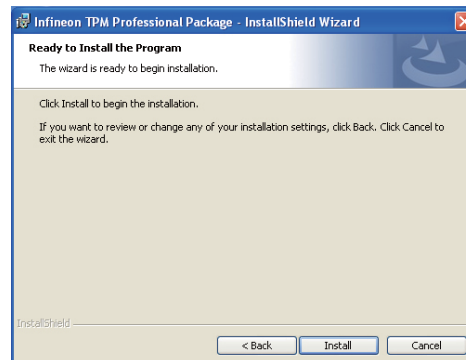

7. TPM requires installing the Microsoft Visual C++ package prior to installing the utility. Click Install.

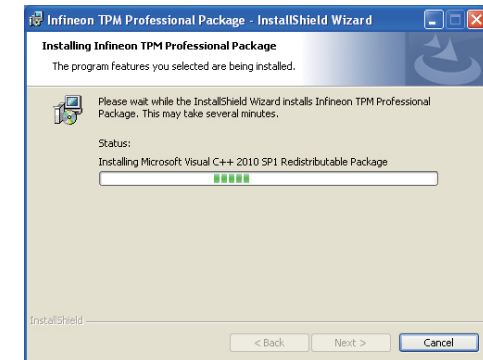

8. The setup program is currently installing the Microsoft Visual C++ package.

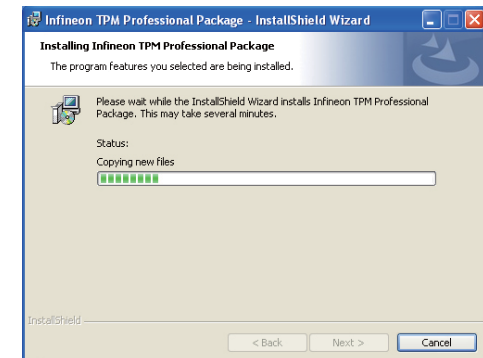

9. Click Finish.



10. Click "Yes" to restart your system.

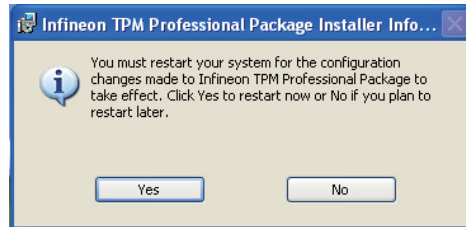

Intel USB 3.0 Drivers (For Windows 7 Only)

To install the driver, click "Intel USB 3.0 Driver" on the main menu.

1. Setup is ready to install the driver. Click Next.

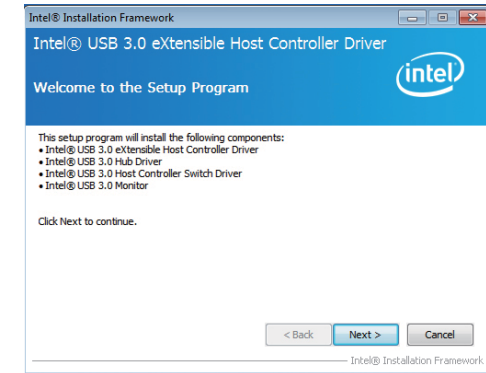

2. Read the license agreement then click Yes.

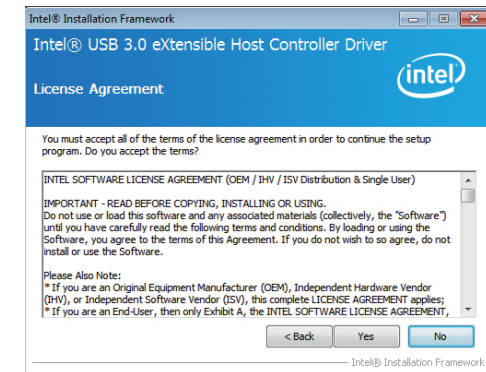

- Go through the readme document for more installation tips then click Next.

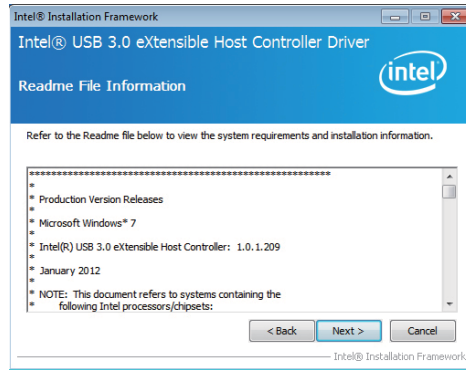

- Setup is currently installing the driver. After installation has completed, click Next.

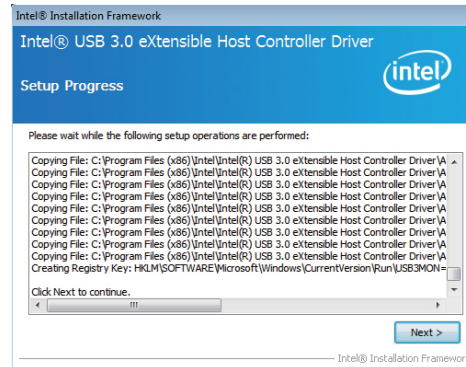

- After completing installation, click Finish.



Adobe Acrobat Reader 9.3

To install the reader, click “Adobe Acrobat Reader 9.3” on the main menu.

- Click Next to install or click Change Destination Folder to select another folder.

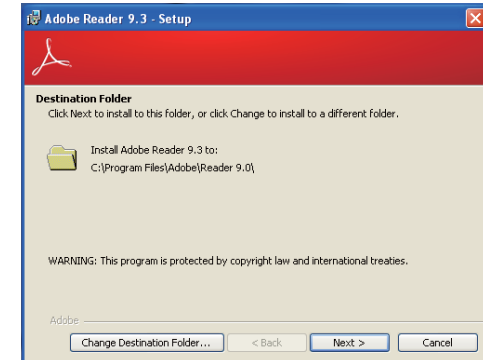

- Click Install to begin installation.

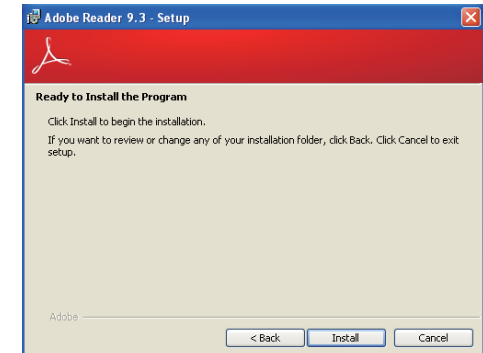

- Click Finish to exit installation.

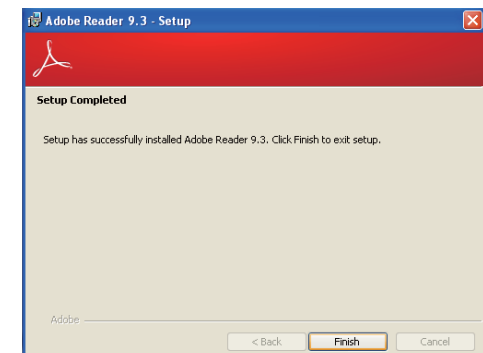

Chapter 5 - Digital I/O Programming Guide

Register Description

The Input Port Register (register 0) reflects the incoming logic levels of the pins, regardless of whether the pin is defined as an input or output by the Configuration Register. They act only on the read operation. Writes to this register have no effect. The default value (X) is determined by the externally applied logic level. Before a read operation, a write transmission is sent with the command byte to indicate to the I²C device that the Input Port Register will be accessed next.

Register 0 (Input Port Register)

BIT	I-7	I-6	I-5	I-4	I-3	I-2	I-1	I-0
DEFAULT	X	X	X	X	X	X	X	X

The Output Port Register (register 1) shows the outgoing logic levels of the pins defined as outputs by the Configuration Register. Bit values in this register have no effect on pins defined as inputs. In turns, reads from this register reflect the value that is in the flip-flop controlling the output selection, not the actual pin value.

Register 1 (Output Port Register)

BIT	O-7	O-6	O-5	O-4	O-3	O-2	O-1	O-0
DEFAULT	1	1	1	1	1	1	1	1

The Polarity Inversion Register (register 2) allows polarity inversion of the pins defined as inputs by the Configuration Register. If a bit in this register is set (written with 1), the corresponding port pin's polarity is inverted. If a bit in this register is clear (written with a 0), the corresponding port pin's original polarity is retained.

Register 2 (Polarity Inversion Register)

BIT	N-7	N-6	N-5	N-4	N-3	N-2	N-1	N-0
DEFAULT	0	0	0	0	0	0	0	0

The Configuration Register (register 3) configures the direction of the I/O pins. If a bit in this register is set to 1, the corresponding port pin is enabled as an input with a high-impedance output driver. If a bit in this register is cleared to 0, the corresponding port pin is enabled as an input.

Register 3 (Configuration Register)

BIT	C-7	C-6	C-5	C-4	C-3	C-2	C-1	C-0
DEFAULT	1	1	1	1	1	1	1	1

Function Description

I2CWriteByte(SlaveAddr, SubAddr, Data):
Write a Byte data to a specified I2C Device.

I2CReadByte(SlaveAddr, SubAddr, *Data):
Read a Byte data from a specified I2C Device.

SetBit(*Data, Bit) :
Set Data bit n as "1".

ClrBit(*Data, Bit) :
Set Data bit n as "0".

GetBit(Data, Bit) :
Return the value of data bit n.

Sample Code

GPIO Configuration

```
#define SLAVE_ADDR      0x42
#define INPUT_PORT     0x00
#define OUTPUT_PORT    0x01
#define INVERSION_PORT 0x02
#define COMFIG_PORT    0x03

GpioConfig(int PinNum, int Mode)
{
    BYTE Data;
    BYTE TempPinNum = PinNum%8;

    //Pin0-7 Input/Output Configuration
    I2C_ReadByte(SLAVE_ADDR, COMFIG_PORT, &Data);
    if(Mode == 1){SetBit(&Data, TempPinNum);} //Input
    else      {ClrBit(&Data, TempPinNum);} //Output
    I2C_WriteByte(SLAVE_ADDR, COMFIG_PORT, Data);

    return 1;
}
```

GPIO Output Process

```
#define SLAVE_ADDR      0x42
#define INPUT_PORT     0x00
#define OUTPUT_PORT    0x01
#define INVERSION_PORT 0x02
#define COMFIG_PORT    0x03

GpioOut(int PinNum, int Level)
{
    BYTE Data;
    BYTE TempPinNum = PinNum%8;

    //Pin0-7
    I2C_ReadByte(SLAVE_ADDR, OUTPUT_PORT, &Data);
    if(Level == 0){ClrBit(&Data, TempPinNum);}
    else      {SetBit(&Data, TempPinNum);}
    I2C_WriteByte(SLAVE_ADDR, OUTPUT_PORT, Data);

    return 1;
}
```

GPIO Input Process

```
#define SLAVE_ADDR      0x42
#define INPUT_PORT     0x00
#define OUTPUT_PORT    0x01
#define INVERSION_PORT 0x02
#define COMFIG_PORT    0x03

GpioIn(int PinNum, int *Status)
{
    BYTE Data;
    BYTE Group = PinNum/8;
    BYTE TempPinNum = PinNum%8;

    //Pin0-7
    I2C_ReadByte(SLAVE_ADDR, INPUT_PORT, &Data);
    *Status = GetBit(Data, TempPinNum);

    return 1;
}
```

Appendix A - Watchdog Sample Code

;Software programming example:

```

;-----
;(1) Enter Super IO Configuration mode
;-----
MOV     DX,4EH
MOV     AL,87H
OUT     DX,AL
OUT     DX,AL

;-----
;(2) Configuration Logical Device 8, register CRF0/CRF1 (WDT Control/WDT
timer)
;-----
MOV     DX,4EH
MOV     AL,07H           ;Ready to Program Logical Device
OUT     DX,AL

MOV     DX,4FH
MOV     AL,08H           ;Select Logical Device 8
OUT     DX,AL

MOV     DX,4EH
MOV     AL, F1H           ;Select watchdog timer register
OUT     DX,AL

MOV     DX,4FH
MOV     AL,10H           ;Set watchdog timer value
OUT     DX,AL

MOV     DX,4EH
MOV     AL, F0H           ;Select watchdog Control Register
OUT     DX,AL

MOV     DX,4FH
MOV     AL,02H           ;Set Watchdog Control Value
OUT     DX,AL

;-----
;(1) Exit extended function mode
;-----
MOV     DX,4EH
MOV     AL,AAH
OUT     DX,AL

```

Appendix B - System Error Message

When the BIOS encounters an error that requires the user to correct something, either a beep code will sound or a message will be displayed in a box in the middle of the screen and the message, PRESS F1 TO CONTINUE, CTRL-ALT-ESC or DEL TO ENTER SETUP, will be shown in the information box at the bottom. Enter Setup to correct the error.

Error Messages

One or more of the following messages may be displayed if the BIOS detects an error during the POST. This list indicates the error messages for all Awards BIOSes:

CMOS BATTERY HAS FAILED

The CMOS battery is no longer functional. It should be replaced.



Important:

Danger of explosion if battery incorrectly replaced. Replace only with the same or equivalent type recommended by the manufacturer. Dispose of used batteries according to the battery manufacturer's instructions.

CMOS CHECKSUM ERROR

Checksum of CMOS is incorrect. This can indicate that CMOS has become corrupt. This error may have been caused by a weak battery. Check the battery and replace if necessary.

DISPLAY SWITCH IS SET INCORRECTLY

The display switch on the motherboard can be set to either monochrome or color. This indicates the switch is set to a different setting than indicated in Setup. Determine which setting is correct, either turn off the system and change the jumper or enter Setup and change the VIDEO selection.

Standard Status Codes

PEI Status Codes

0x11	Pre-memory CPU initialization is started
0x15	Pre-memory North Bridge initialization is started
0x19	Pre-memory South Bridge initialization is started
0x2A	OEM pre-memory initialization codes
0x2B	Memory initialization. Serial Presence Detect (SPD) data reading
0x2C	Memory initialization. Memory presence detection
0x2D	Memory initialization. Programming memory timing information
0x2E	Memory initialization. Configuring memory
0x2F	Memory initialization (other).

PEI Error Codes

0x50	Memory initialization error. Invalid memory type or incompatible memory speed
0x51	Memory initialization error. SPD reading has failed
0x52	Memory initialization error. Invalid memory size or memory modules do not match.
0x53	Memory initialization error. No usable memory detected

DXE Phase Codes

0x92	PCI Bus initialization is started
0x93	PCI Bus Hot Plug Controller Initialization
0x94	PCI Bus Enumeration
0x95	PCI Bus Request Resources
0x96	PCI Bus Assign Resources
0x99	Super IO Initialization
0x9A	USB initialization is started
0x9B	USB Reset
0x9C	USB Detect
0x9D	USB Enable
0xA0	IDE initialization is started
0xA1	IDE Reset
0xA2	IDE Detect
0xA3	IDE Enable
0xAE	Legacy Boot event
0xB4	USB hot plug
0xB6	Clean-up of NVRAM
0xB7	Configuration Reset (reset of NVRAM settings)

DXE Error Codes

0xD6	No Console Output Devices are found
0xD7	No Console Input Devices are found
0xD8	Invalid password

ACPI Checkpoints

0x03	System is entering S3 sleep state
0x04	System is entering S4 sleep state
0x05	System is entering S5 sleep state
0x30	System is waking up from the S3 sleep state
0x40	System is waking up from the S4 sleep state
0xAC	System has transitioned into ACPI mode. Interrupt controller is in PIC mode.
0xAA	System has transitioned into ACPI mode. Interrupt controller is in APIC mode.

Beep Code

6 beeps	Flash update is failed
---------	------------------------

Appendix C - Troubleshooting Checklist

Troubleshooting Checklist

This chapter of the manual is designed to help you with problems that you may encounter with your personal computer. To efficiently troubleshoot your system, treat each problem individually. This is to ensure an accurate diagnosis of the problem in case a problem has multiple causes.

Some of the most common things to check when you encounter problems while using your system are listed below.

1. The power switch of each peripheral device is turned on.
2. All cables and power cords are tightly connected.
3. The electrical outlet to which your peripheral devices are connected is working. Test the outlet by plugging in a lamp or other electrical device.
4. The monitor is turned on.
5. The display's brightness and contrast controls are adjusted properly.
6. All add-in boards in the expansion slots are seated securely.
7. Any add-in board you have installed is designed for your system and is set up correctly.

Monitor/Display

If the display screen remains dark after the system is turned on:

1. Make sure that the monitor's power switch is on.
2. Check that one end of the monitor's power cord is properly attached to the monitor and the other end is plugged into a working AC outlet. If necessary, try another outlet.
3. Check that the video input cable is properly attached to the monitor and the system's display adapter.
4. Adjust the brightness of the display by turning the monitor's brightness control knob.

The picture seems to be constantly moving.

1. The monitor has lost its vertical sync. Adjust the monitor's vertical sync.
2. Move away any objects, such as another monitor or fan, that may be creating a magnetic field around the display.
3. Make sure your video card's output frequencies are supported by this monitor.

The screen seems to be constantly wavering.

1. If the monitor is close to another monitor, the adjacent monitor may need to be turned off. Fluorescent lights adjacent to the monitor may also cause screen wavering.

Power Supply

When the computer is turned on, nothing happens.

1. Check that one end of the AC power cord is plugged into a live outlet and the other end properly plugged into the back of the system.
2. Make sure that the voltage selection switch on the back panel is set for the correct type of voltage you are using.
3. The power cord may have a "short" or "open". Inspect the cord and install a new one if necessary.

Floppy Drive

The computer cannot access the floppy drive.

1. The floppy diskette may not be formatted. Format the diskette and try again.
2. The diskette may be write-protected. Use a diskette that is not write-protected.
3. You may be writing to the wrong drive. Check the path statement to make sure you are writing to the targeted drive.
4. There is not enough space left on the diskette. Use another diskette with adequate storage space.

Hard Drive

Hard disk failure.

1. Make sure the correct drive type for the hard disk drive has been entered in the BIOS.
2. If the system is configured with two hard drives, make sure the bootable (first) hard drive is configured as Master and the second hard drive is configured as Slave. The master hard drive must have an active/bootable partition.

Excessively long formatting period.

If your hard drive takes an excessively long period of time to format, it is likely a cable connection problem. However, if your hard drive has a large capacity, it will take a longer time to format.

Serial Port

The serial device (modem, printer) doesn't output anything or is outputting garbled characters.

1. Make sure that the serial device's power is turned on and that the device is on-line.
2. Verify that the device is plugged into the correct serial port on the rear of the computer.
3. Verify that the attached serial device works by attaching it to a serial port that is working and configured correctly. If the serial device does not work, either the cable or the serial device has a problem. If the serial device works, the problem may be due to the onboard I/O or the address setting.
4. Make sure the COM settings and I/O address are configured correctly.

Keyboard

Nothing happens when a key on the keyboard was pressed.

1. Make sure the keyboard is properly connected.
2. Make sure there are no objects resting on the keyboard and that no keys are pressed during the booting process.

System Board

1. Make sure the add-in card is seated securely in the expansion slot. If the add-in card is loose, power off the system, re-install the card and power up the system.
2. Check the jumper settings to ensure that the jumpers are properly set.
3. Verify that all memory modules are seated securely into the memory sockets.
4. Make sure the memory modules are in the correct locations.
5. If the board fails to function, place the board on a flat surface and seat all socketed components. Gently press each component into the socket.
6. If you made changes to the BIOS settings, re-enter setup and load the BIOS defaults.