



KD331-C236/Q170

MicroATX Industrial Motherboard

User's Manual

Copyright

This publication contains information that is protected by copyright. No part of it may be reproduced in any form or by any means or used to make any transformation/adaptation without the prior written permission from the copyright holders.

This publication is provided for informational purposes only. The manufacturer makes no representations or warranties with respect to the contents or use of this manual and specifically disclaims any express or implied warranties of merchantability or fitness for any particular purpose. The user will assume the entire risk of the use or the results of the use of this document. Further, the manufacturer reserves the right to revise this publication and make changes to its contents at any time, without obligation to notify any person or entity of such revisions or changes.

Changes after the publication's first release will be based on the product's revision. The website will always provide the most updated information.

© 2018. All Rights Reserved.

Trademarks

Product names or trademarks appearing in this manual are for identification purpose only and are the properties of the respective owners.

FCC and DOC Statement on Class B

This equipment has been tested and found to comply with the limits for a Class B digital device, pursuant to Part 15 of the FCC rules. These limits are designed to provide reasonable protection against harmful interference when the equipment is operated in a residential installation. This equipment generates, uses and can radiate radio frequency energy and, if not installed and used in accordance with the instruction manual, may cause harmful interference to radio communications. However, there is no guarantee that interference will not occur in a particular installation. If this equipment does cause harmful interference to radio or television reception, which can be determined by turning the equipment off and on, the user is encouraged to try to correct the interference by one or more of the following measures:

- Reorient or relocate the receiving antenna.
- Increase the separation between the equipment and the receiver.
- Connect the equipment into an outlet on a circuit different from that to which the receiver is connected.
- Consult the dealer or an experienced radio TV technician for help.

Notice:

1. The changes or modifications not expressly approved by the party responsible for compliance could void the user's authority to operate the equipment.
2. Shielded interface cables must be used in order to comply with the emission limits.

Table of Contents

Copyright.....	2
Trademarks	2
FCC and DOC Statement on Class B.....	2
Warranty.....	4
Static Electricity Precautions.....	4
Safety Measures	4
About the Package.....	5
Optional Items.....	5
Before Using the System Board.....	5
Chapter 1 - Introduction.....	6
Specifications	6
Features.....	7
Chapter 2 - Hardware Installation.....	9
Board Layout.....	9
System Memory.....	9
Installing the DIMM Module	10
CPU	11
Installing the CPU.....	12
Installing the Fan and Heat Sink.....	14
Block Diagram.....	15
Mechanical Drawing	16
Jumper Settings	16
Clear CMOS Data.....	16
COM1/COM2 RS232/422/485 Select.....	17
COM1/COM2 RS232/Power Select.....	18
USB Power Select	18
Rear Panel I/O Ports.....	19
PS/2 Keyboard/Mouse Port.....	19
COM (Serial) Ports.....	20
Graphics Interfaces.....	21

RJ45 LAN Ports.....	22
USB Ports.....	22
Audio	23
I/O Connectors	24
SATA (Serial ATA) Connectors.....	24
Digital I/O Connector.....	24
Cooling Fan Connectors.....	25
Power Connectors.....	25
Chassis Intrusion Connector	26
Front Panel Connector	26
LAN LED Connector	27
S/PDIF Connector	27
SMBus Connector	28
Standby Power LED	28
LPC Connector.....	29
Connecting the EXT-RS232/RS485 Card to the Motherboard	29
Expansion Slots	30
Battery.....	30

Chapter 3 - BIOS Setup..... 31

Overview.....	31
Insyde BIOS Setup Utility.....	32
Main	32
Advanced	32
Security.....	45
Boot.....	45
Exit.....	46
Updating the BIOS	47
Notice: BIOS SPI ROM.....	47

Chapter 4 - Supported Software

Chapter 5 - RAID

Chapter 6 - Intel AMT Settings..... 59

Warranty

1. Warranty does not cover damages or failures that arised from misuse of the product, inability to use the product, unauthorized replacement or alteration of components and product specifications.
2. The warranty is void if the product has been subjected to physical abuse, improper installation, modification, accidents or unauthorized repair of the product.
3. Unless otherwise instructed in this user's manual, the user may not, under any circumstances, attempt to perform service, adjustments or repairs on the product, whether in or out of warranty. It must be returned to the purchase point, factory or authorized service agency for all such work.
4. We will not be liable for any indirect, special, incidental or consequential damages to the product that has been modified or altered.

Static Electricity Precautions

It is quite easy to inadvertently damage your PC, system board, components or devices even before installing them in your system unit. Static electrical discharge can damage computer components without causing any signs of physical damage. You must take extra care in handling them to ensure against electrostatic build-up.

1. To prevent electrostatic build-up, leave the system board in its anti-static bag until you are ready to install it.
2. Wear an antistatic wrist strap.
3. Do all preparation work on a static-free surface.
4. Hold the device only by its edges. Be careful not to touch any of the components, contacts or connections.
5. Avoid touching the pins or contacts on all modules and connectors. Hold modules or connectors by their ends.



Important:

Electrostatic discharge (ESD) can damage your processor, disk drive and other components. Perform the upgrade instruction procedures described at an ESD workstation only. If such a station is not available, you can provide some ESD protection by wearing an antistatic wrist strap and attaching it to a metal part of the system chassis. If a wrist strap is unavailable, establish and maintain contact with the system chassis throughout any procedures requiring ESD protection.

Safety Measures

To avoid damage to the system:

- Use the correct AC input voltage range.

To reduce the risk of electric shock:

- Unplug the power cord before removing the system chassis cover for installation or servicing. After installation or servicing, cover the system chassis before plugging the power cord.

About the Package

The package contains the following items. If any of these items are missing or damaged, please contact your dealer or sales representative for assistance.

- One KD331-C236/Q170 motherboard
- One COM port cable (Length: 300mm, 2 x COM ports)
- One Serial ATA data cable (Length: 500mm)
- One I/O shield
- One M.2 standoff
- One M.2 screw for 2260
- One M.2 screw for 2280

The board and accessories in the package may not come similar to the information listed above. This may differ in accordance to the sales region or models in which it was sold. For more information about the standard package in your region, please contact your dealer or sales representative.

Optional Items

- USB 2.0 port cable (Length: 350/398mm)
- USB 3.0 port cable (Length: 320mm)
- D-SUB cable (with Bracket, Length: 300mm, 2 x DB9)
- Serial ATA data cable (with Lock, Length: 500mm)
- Thermal solution (For 35W, Height: 37.3mm)
- Thermal solution (For 65W, Height: 72.8mm)
- Thermal solution (For 95W, Height: 69.3mm) (for KD631-C236)
- LPC EXT-RS232 module (4 x RS232 ports)
- LPC EXT-RS485 module (4 x RS485 ports)

The board and accessories in the package may not come similar to the information listed above. This may differ in accordance to the sales region or models in which it was sold. For more information about the standard package in your region, please contact your dealer or sales representative.

Before Using the System Board

Before using the system board, prepare basic system components.

If you are installing the system board in a new system, you will need at least the following internal components.

- A CPU
- Memory module
- Storage devices such as hard disk drive, etc.

You will also need external system peripherals you intend to use which will normally include at least a keyboard, a mouse and a video display monitor.

Chapter 1 - Introduction

Specifications

SYSTEM	Processor	KD331-C236: Intel® Xeon® E3 v5/v6 LGA 1151 Socket Processors with TDP up to 80W with C236 SKU 6th/7th Generation Intel® Core™/Pentium®/Celeron® LGA 1151 Socket Processors with TDP up to 65W KD331-Q170: 6th/7th Generation Intel® Core™/Pentium®/Celeron® LGA 1151 Socket Processors with TDP up to 65W
	Chipset	KD331-C236: Intel® C236 Chipset KD331-Q170: Intel® Q170 Chipset
	Memory	KD331-C236: Four 288-pin ECC/Non-ECC DIMM up to 64GB Dual Channel DDR4 2133/2400 MHz KD331-Q170: Four 288-pin DIMM up to 64GB Dual Channel DDR4 2133/2400 MHz
	BIOS	Insyde SPI 128Mbit
	GRAPHICS	Controller
	Feature	OpenGL 5.0, DirectX 12, OpenCL 2.1 HW Decode: AVC/H.264, MPEG2, VC1/WMV9, JPEG/MJPEG, HEVC/H265, VP8, VP9 HW Encode: MPEG2, AVC/H264, JPEG, HEVC/H265, VP8, VP9
	Display	1 x VGA 1 x DVI-I (DVI-D signal) 1 x DP++ VGA: resolution up to 1920x1200 @ 60Hz DVI-D: resolution up to 1920x1200 @ 60Hz DP++: resolution up to 4096x2106 @ 60Hz
	Triple Displays	VGA + DVI-I (DVI-D signal) + DP++
EXPANSION	Interface	KD331-C236: 2 x PCIe x16 (1 x16 or 2 x8 signal) (Gen3) 2 x PCIe x4 (Gen 3) 1 x M.2 M Key (2260/2280) (Optane memory support) KD331-Q170: 2 x PCIe x16 (1 x16 or 2 x8 signal) (Gen 3) 2 x PCIe x4 (Gen 3) 1 x M.2 M Key (2260/2280)
AUDIO	Audio Codec	Realtek ALC888S-VD2-GR
ETHERNET	Controller	3 x Intel® I211AT PCIe (10/100/1000Mbps) 1 x Intel® I219LM PCIe with iAMT11.0 (10/100/1000Mbps) (only Xeon and Core™ i7/i5 support iAMT)
REAR I/O	Ethernet	4 x GbE (RJ-45)
	USB	4 x USB 3.0 2 x USB 2.0
	Serial	1 x RS-232/422/485 (RS-232 with power) (DB-9)
	PS/2	1 x PS/2 (mini-DIN-6)
	Display	1 x VGA 1 x DVI-I (DVI-D signal) 1 x DP++

INTERNAL I/O	Serial	1 x RS-232/422/485 (RS-232 with power) (2.54mm pitch) 4 x RS-232 (2.54mm pitch)
	USB	2 x USB 3.0 (2.00mm pitch) 4 x USB 2.0 (2.54mm pitch) or 2 x USB2.0 (2.54mm pitch) + 1 x Vertical USB 2.0 (opt.)
	Audio	1 x Front Audio Header 1 x S/PDIF
	SATA	5 x SATA 3.0 (up to 6Gb/s) RAID 0/1/5/10
	DIO	1 x 8-bit DIO
	LPC	1 x LPC (supports LPC EXT-RS232/RS485 module)
	SMBus	1 x SMBus
WATCHDOG TIMER	Output & Interval	System Reset, Programmable via Software from 1 to 255 Seconds
SECURITY	TPM	Infineon TPM2.0/1.2 (optional)
POWER	Type	ATX
	Connector	8-pin ATX 12V power 24-pin ATX power
	RTC Battery	CR2032 Coin Cell
OS SUPPORT		Windows 10 IoT Enterprise 64-bit
ENVIRONMENT	Temperature	Operating: 0 to 60°C Storage: -40 to 85°C
	Humidity	Operating: 5 to 90% RH Storage: 5 to 90% RH
MECHANICAL	Dimensions	microATX Form Factor 244mm (9.6") x 244mm (9.6")
CERTIFICATIONS		CE, FCC, RoHS, UL

Features

• Watchdog Timer

The Watchdog Timer function allows your application to regularly “clear” the system at the set time interval. If the system hangs or fails to function, it will reset at the set time interval so that your system will continue to operate.

• DDR4

DDR4 delivers increased system bandwidth and improves performance. The advantages of DDR4 provide an extended battery life and improve the performance at a lower power than DDR3/DDR2.

• Graphics

The integrated Intel® HD graphics engine delivers an excellent blend of graphics performance and features to meet business needs. It provides excellent video and 3D graphics with outstanding graphics responsiveness. These enhancements deliver the performance and compatibility needed for today's and tomorrow's business applications. Supports 1 x VGA, 1 x DVI-I (DVI-D signal) and 1 x DP++ interfaces for triple display outputs.

• PCI Express

PCI Express is a high bandwidth I/O infrastructure that possesses the ability to scale speeds by forming multiple lanes. The PCI Express architecture also supports high performance graphics infrastructure by enhancing the capability of a PCIe x16 Gen 3 at 16GB/s bandwidth.

• Serial ATA

Serial ATA is a storage interface that is compliant with SATA 1.0a specification. With speed of up to 6Gb/s (SATA 3.0), it improves hard drive performance faster than the standard parallel ATA whose data transfer rate is 100MB/s.

• Gigabit LAN

Four Intel® Gigabit LAN controllers (3 x Intel® I211AT PCIe and 1 x Intel® I219LM PCIe) support up to 1Gbps data transmission.

• Audio

The Realtek ALC888S-VD2-GR audio codec provides 5.1-channel High Definition audio output.

• Wake-On-PS/2

This function allows you to use the PS/2 keyboard or PS/2 mouse to power-on the system.



Important:

The 5V_standby power source of your power supply must support $\geq 720\text{mA}$.

• Wake-On-LAN

This feature allows the network to remotely wake up a Soft Power Down (Soft-Off) PC. It is supported via the onboard LAN port or via a PCI LAN card that uses the PCI PME (Power Management Event) signal. However, if your system is in the Suspend mode, you can power-on the system only through an IRQ or DMA interrupt.



Important:

The 5V_standby power source of your power supply must support $\geq 720\text{mA}$.

• Wake-On-USB

This function allows you to use a USB keyboard or USB mouse to wake up a system from the S3 (STR - Suspend To RAM) state.



Important:

If you are using the Wake-On-USB Keyboard/Mouse function for 2 USB ports, the 5V_standby power source of your power supply must support $\geq 1.5\text{A}$. For 3 or more USB ports, the 5V_standby power source of your power supply must support $\geq 2\text{A}$.

• RTC Timer

The RTC installed on the system board allows your system to automatically power-on on the set date and time.

• ACPI STR

The system board is designed to meet the ACPI (Advanced Configuration and Power Interface) specification. ACPI has energy saving features that enables PCs to implement Power Management and Plug-and-Play with operating systems that support OS Direct Power Management. ACPI when enabled in the Power Management Setup will allow you to use the Suspend to RAM function.

With the Suspend to RAM function enabled, you can power-off the system at once by pressing the power button or selecting “Standby” when you shut down Windows® without having to go through the sometimes tiresome process of closing files, applications and operating system. This is because the system is capable of storing all programs and data files during the entire operating session into RAM (Random Access Memory) when it powers-off. The operating session will resume exactly where you left off the next time you power-on the system.



Important:

The 5V_standby power source of your power supply must support $\geq 720\text{mA}$.

- **Power Failure Recovery**

When power returns after an AC power failure, you may choose to either power-on the system manually or let the system power-on automatically.

- **USB**

The system board supports the new USB 3.0. It is capable of running at a maximum transmission speed of up to 5 Gbit/s (625 MB/s) and is faster than USB 2.0 (480 Mbit/s, or 60 MB/s) and USB 1.1 (12Mb/s). USB 3.0 reduces the time required for data transmission, reduces power consumption, and is backward compatible with USB 2.0. It is a marked improvement in device transfer speeds between your computer and a wide range of simultaneously accessible external Plug and Play peripherals.

Chapter 2 - Hardware Installation

Board Layout

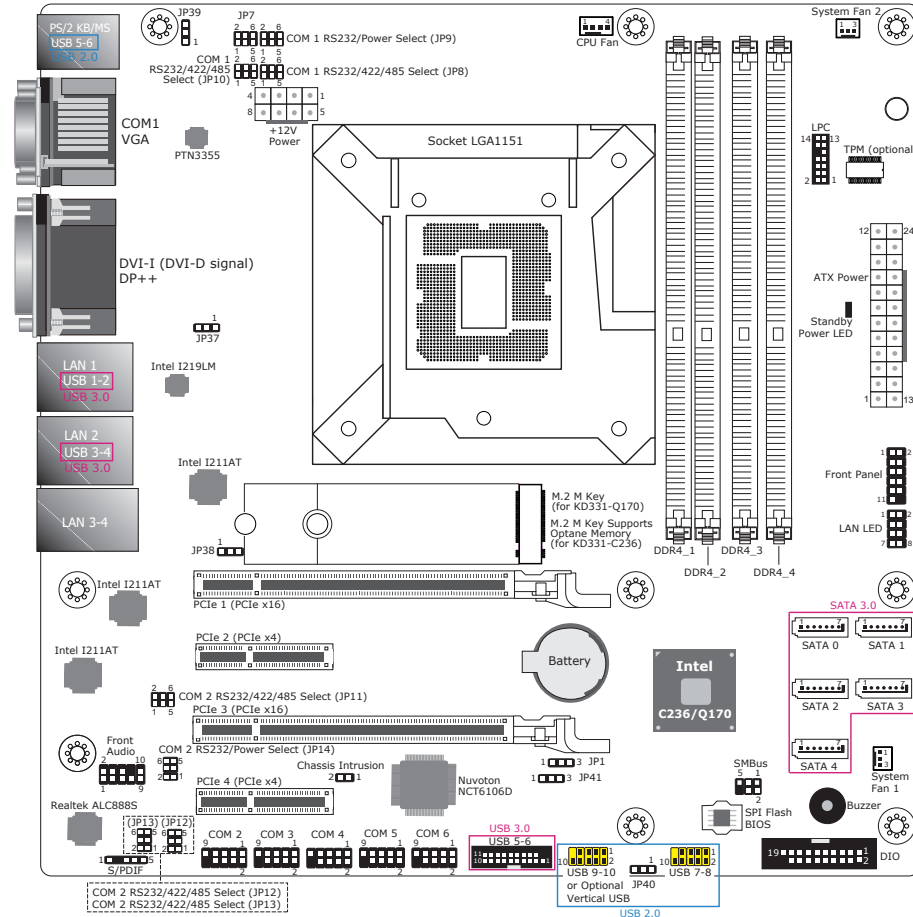

Important: Electrostatic discharge (ESD) can damage your board, processor, disk drives, add-in boards, and other components. Perform installation procedures at an ESD workstation only. If such a station is not available, you can provide some ESD protection by wearing an antistatic wrist strap and attaching it to a metal part of the system chassis. If a wrist strap is unavailable, establish and maintain contact with the system chassis throughout any procedures requiring ESD protection.

System Memory

Important: When the Standby Power LED lights red, it indicates that there is power on the system board. Power-off the PC then unplug the power cord prior to installing any devices. Failure to do so will cause severe damage to the motherboard and components.

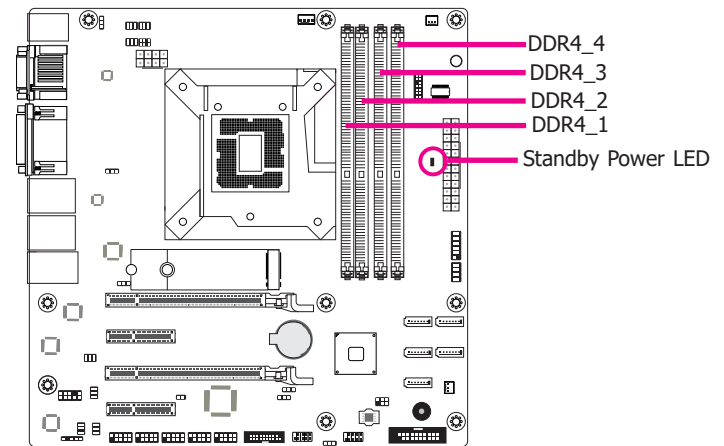

Features

- Four 288-pin ECC DIMM up to 64GB (KD331-C236)
Four 288-pin DIMM up to 64GB (KD331-Q170)
- Dual Channel DDR4 2133/2400 MHz

The system board supports the following memory interface.

Single Channel (SC)

Data will be accessed in chunks of 64 bits (8B) from the memory channels.

Dual Channel (DC)

Data will be accessed in chunks of 128 bits from the memory channels. Dual channel provides better system performance because it doubles the data transfer rate.

Single Channel	DIMMs are on the same channel. DIMMs in a channel can be identical or completely different. However, we highly recommend using identical DIMMs. Not all slots need to be populated.
Dual Channel	DIMMs of the same memory configuration are on different channels.

Installing the DIMM Module



Note:

The system board used in the following illustrations may not resemble the actual board. These illustrations are for reference only.

1. Make sure the PC and all other peripheral devices connected to it has been powered down.
2. Disconnect all power cords and cables.
3. Locate the DIMM socket on the system board.
4. Push the “ejector tabs” which are at the ends of the socket to the side.



5. Note how the module is keyed to the socket.

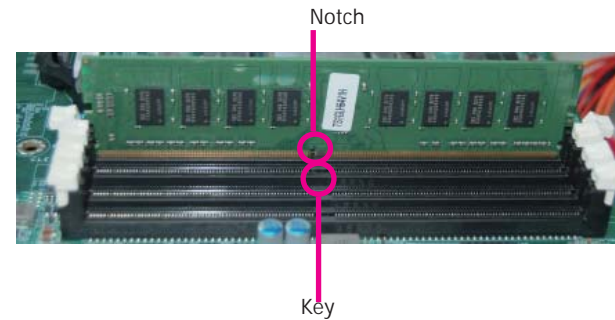

6. Grasping the module by its edges, position the module above the socket with the “notch” in the module aligned with the “key” on the socket. The keying mechanism ensures the module can be plugged into the socket in only one way.



7. Seat the module vertically, pressing it down firmly until it is completely seated in the socket.



8. The ejector tabs at the ends of the socket will automatically snap into the locked position to hold the module in place.



CPU

The system board is equipped with a surface mount LGA 1151 socket. This socket is exclusively designed for installing a LGA 1151 packaged Intel CPU.



Important:

1. Before you proceed, make sure (1) the LGA 1151 socket comes with a protective cap, (2) the cap is not damaged and (3) the socket's contact pins are not bent. If the cap is missing or the cap and/or contact pins are damaged, contact your dealer immediately.
2. Make sure to keep the protective cap. RMA requests will be accepted and processed only if the LGA 1151 socket comes with the protective cap.



Note:

The system board used in the following illustrations may not resemble the actual board. These illustrations are for reference only.

Installing the CPU

1. Make sure the PC and all other peripheral devices connected to it has been powered down.
2. Disconnect all power cords and cables.
3. Locate the LGA 1151 CPU socket on the system board.

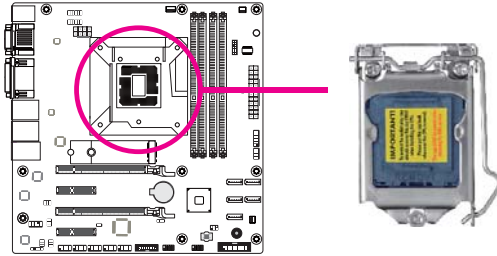

Important:

The CPU socket must not come in contact with anything other than the CPU. Avoid unnecessary exposure. Remove the protective cap only when you are about to install the CPU.

4. Unlock the socket by pushing the load lever down, moving it sideways until it is released from the retention tab; then lift the load lever up.

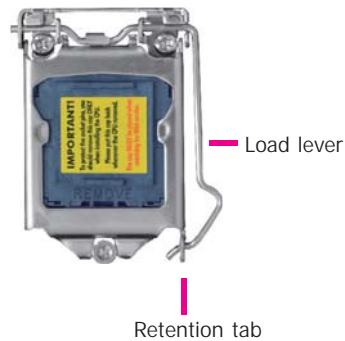

5. Lifting the load lever will at the same time lift the load plate.

Lift the load lever up to the angle shown on the photo.

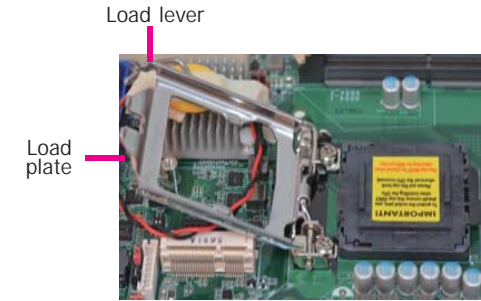

6. Remove the protective cap from the CPU socket. The cap is used to protect the CPU socket against dust and harmful particles. Remove the protective cap only when you are about to install the CPU.

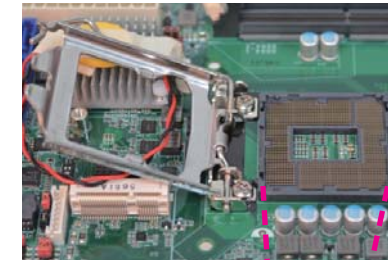

Protective cap

7. Insert the CPU into the socket. The gold triangular mark on the CPU must align with the corner of the CPU socket shown on the photo.

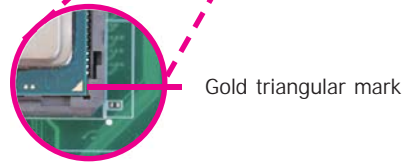

Alignment key

The CPU's notch will at the same time fit into the socket's alignment key.

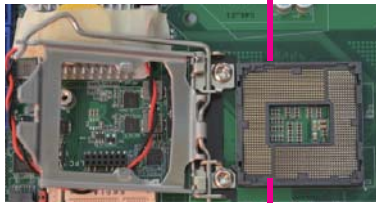

Alignment key



Important:

The CPU will fit in only one orientation and can easily be inserted without exerting any force.



8. Close the load plate then push the load lever down.

While closing the load plate, make sure the front edge of the load plate slides under the retention knob.



9. Hook the load lever under the retention tab.

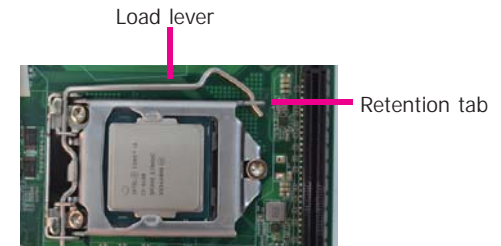

Installing the Fan and Heat Sink

The CPU must be kept cool by using a CPU fan with heat sink. Without sufficient air circulation across the CPU and heat sink, the CPU will overheat damaging both the CPU and system board.



Note:

A boxed Intel® processor already includes the CPU fan and heat sink assembly. If your CPU was purchased separately, make sure to only use Intel®-certified fan and heat sink.

1. Before you install the fan / heat sink, you must apply a thermal paste onto the top of the CPU. The thermal paste is usually supplied when you purchase the fan / heat sink assembly. Do not spread the paste all over the surface. When you later place the heat sink on top of the CPU, the compound will disperse evenly.

Some heat sinks come with a patch of pre-applied thermal paste. Do not apply thermal paste if the fan / heat sink already has a patch of thermal paste on its underside. Peel the strip that covers the paste before you place the fan / heat sink on top of the CPU.

2. Place the heat sink on top of the CPU. The 4 screw around the heat sink, which are used to secure the heat sink onto the system board, must match the 4 mounting holes around the socket.

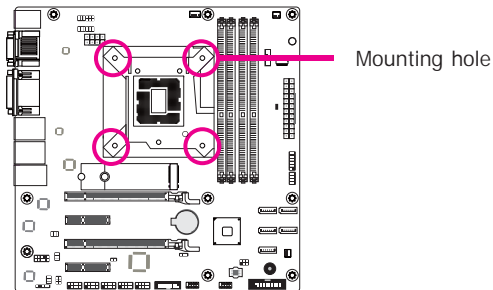

3. Orient the heat sink such that the CPU fan's cable is nearest the CPU fan connector.

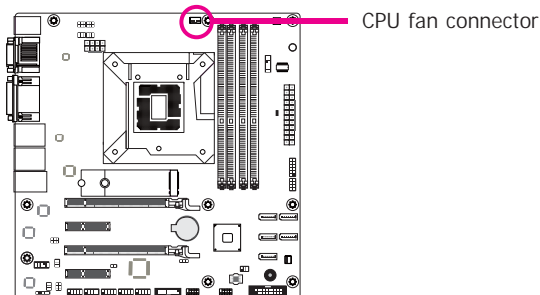

4. Rotate each screw that are diagonally across the heat sink. Perform the same procedure for the other screws.

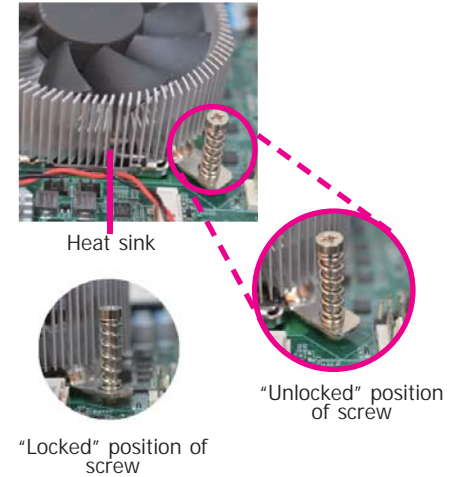

5. Connect the CPU fan's cable to the CPU fan connector on the system board.

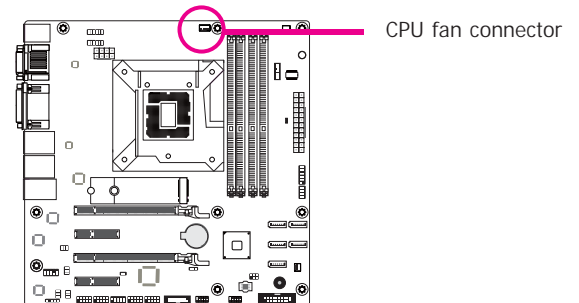

Block Diagram

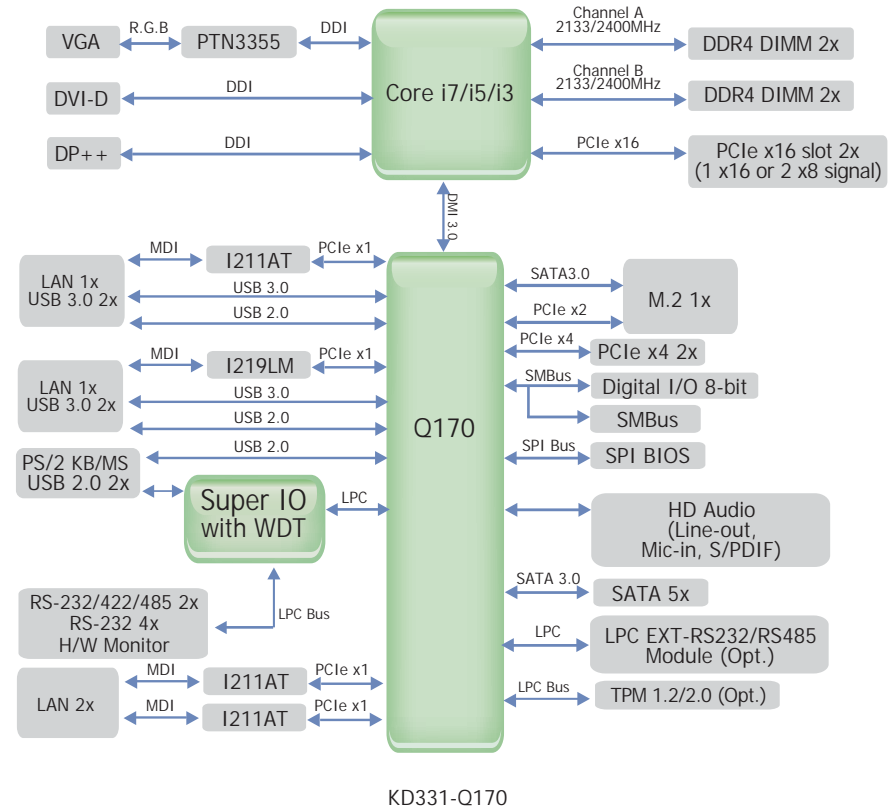
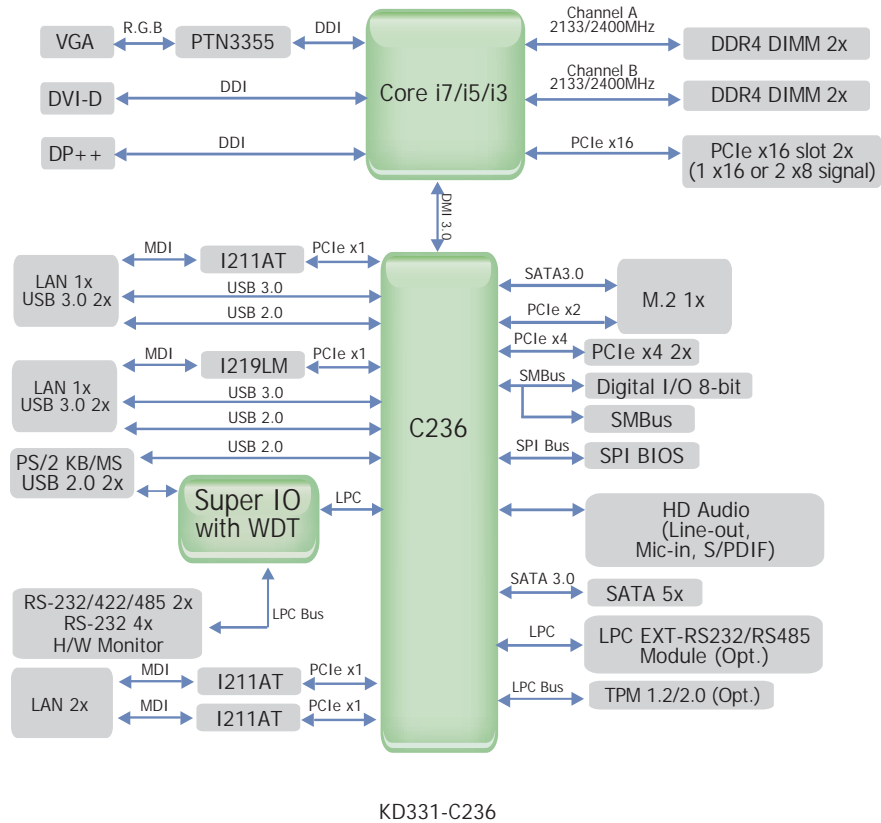

Mechanical Drawing

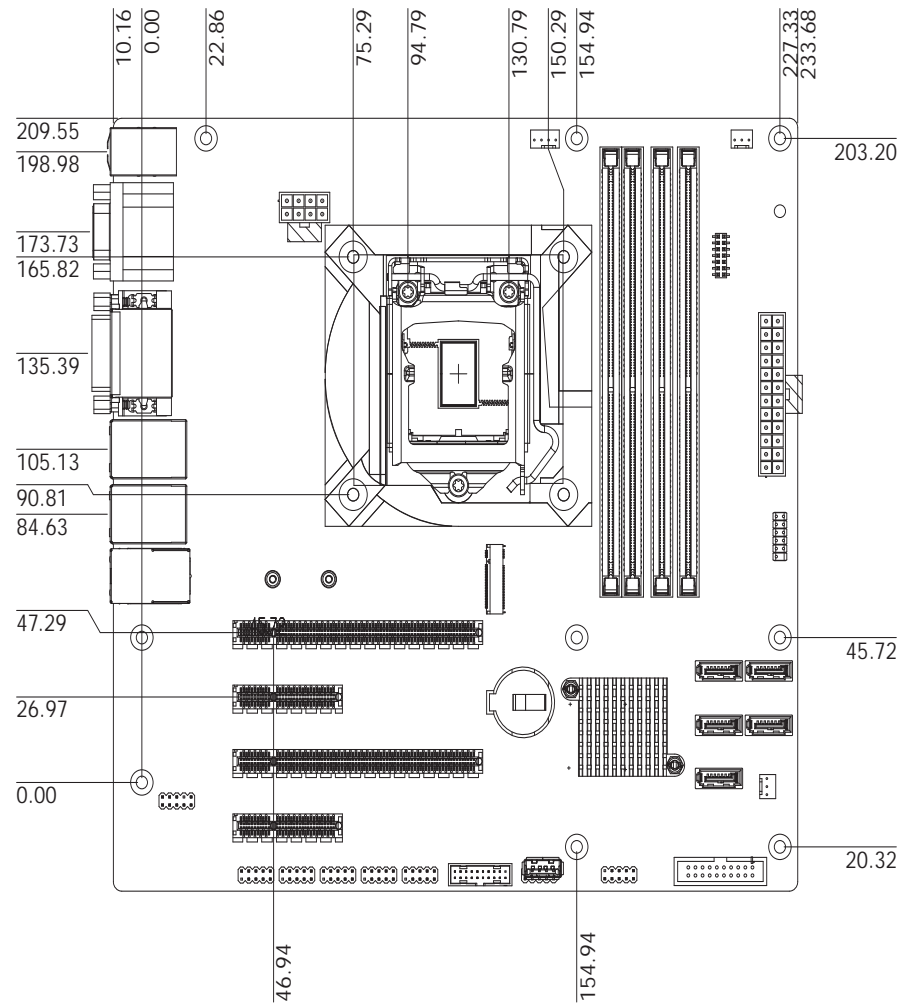

Jumper Settings

Clear CMOS Data

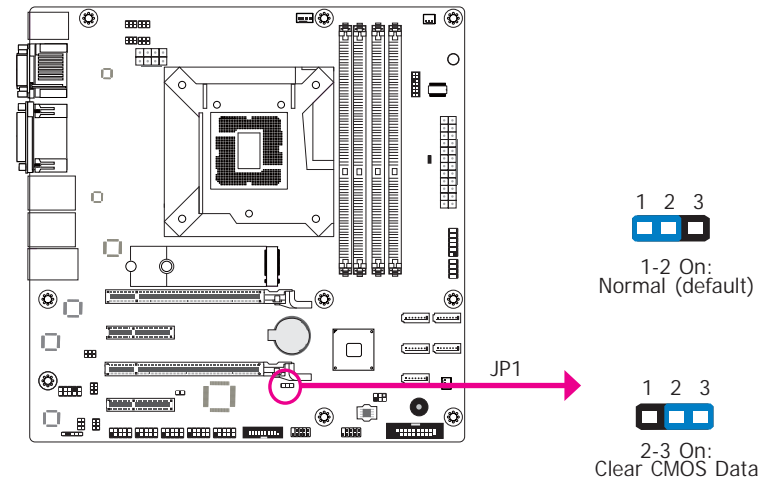

If you encounter the followings,

- CMOS data becomes corrupted.
- You forgot the supervisor or user password.

you can reconfigure the system with the default values stored in the ROM BIOS.

To load the default values stored in the ROM BIOS, please follow the steps below.

- Power-off the system and unplug the power cord.
- Set JP1 pins 2 and 3 to On. Wait for a few seconds and set JP1 back to its default setting, pins 1 and 2 On.
- Now plug the power cord and power-on the system.

COM1/COM2 RS232/422/485 Select

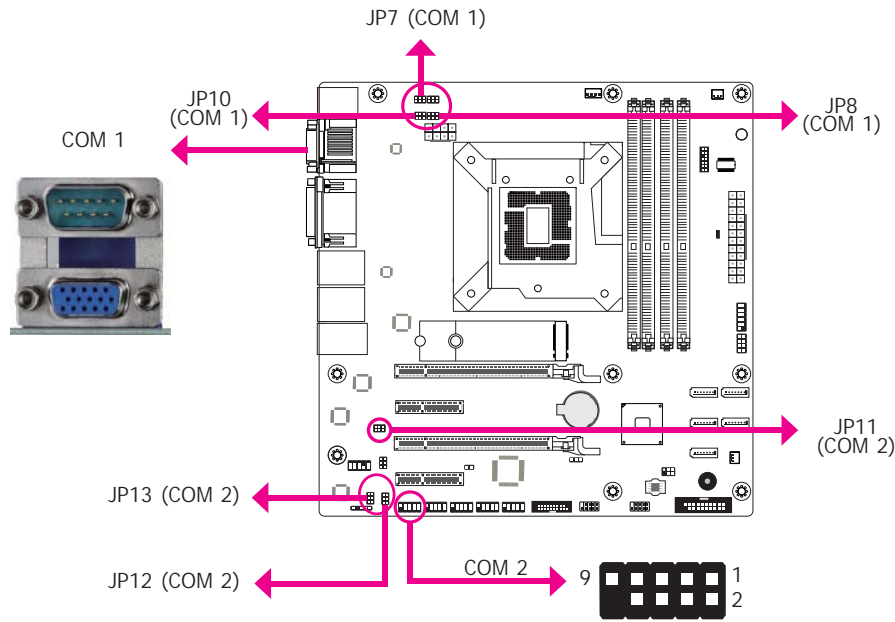

JP7/JP8/JP10 (for COM 1) and JP11/JP12/JP13 (for COM 2) are used to configure the COM ports to RS232, RS422 (Full Duplex) or RS485. When COM 1 RS232/422/485 is selected, JP8 and JP10 must be set in accordance to JP7. When COM 2 RS232/422/485 is selected, JP12 and JP13 must be set in accordance to JP11. The pin functions of the COM ports will vary according to the jumpers' setting.

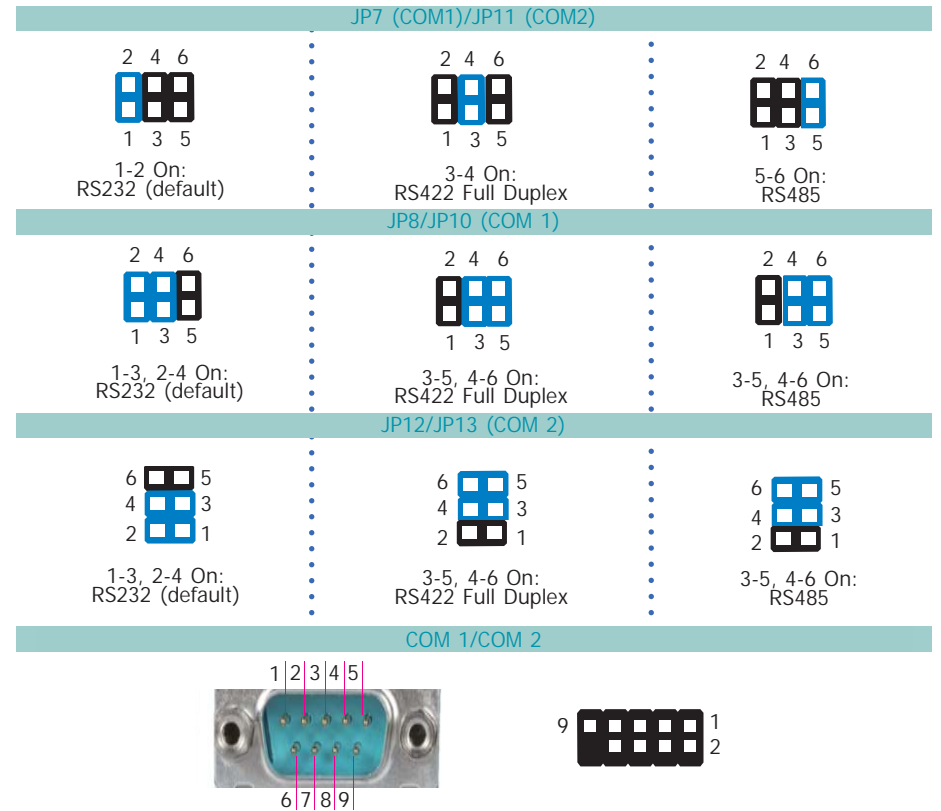

Pin	RS232	RS422 Full Duplex	RS485
1	DCD-	RXD+	DATA+
2	RD	RXD-	DATA-
3	TD	TXD+	N.C.
4	DTR-	TXD-	N.C.
5	GND	GND	GND
6	DSR-	N.C.	N.C.
7	RTS-	N.C.	N.C.
8	CTS-	N.C.	N.C.
9	RI-	N.C.	N.C.

COM1/COM2 RS232 Power Select

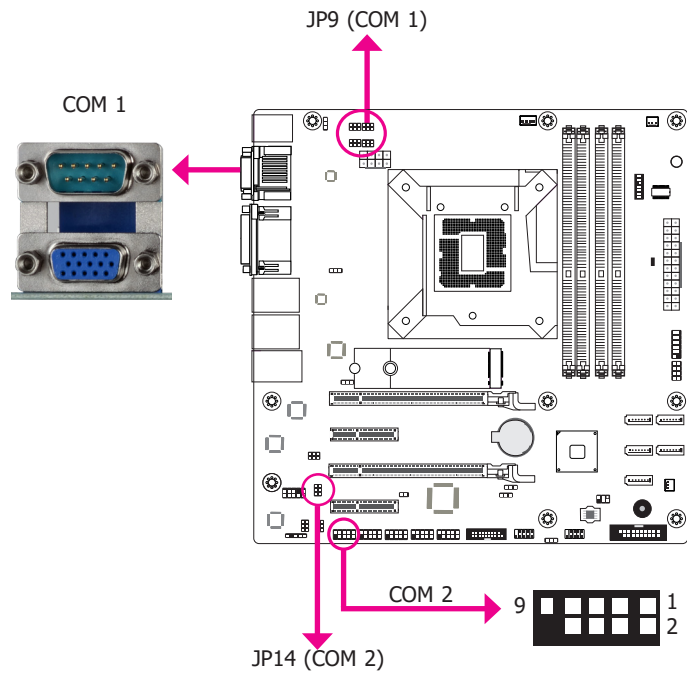

JP9 (for COM 1) and JP14 (for COM 2) are used to configure Serial COM ports to pure RS232 or RS232 with power. The pin functions of COM 1 and COM 2 will vary according to JP9's and JP14's setting respectively.

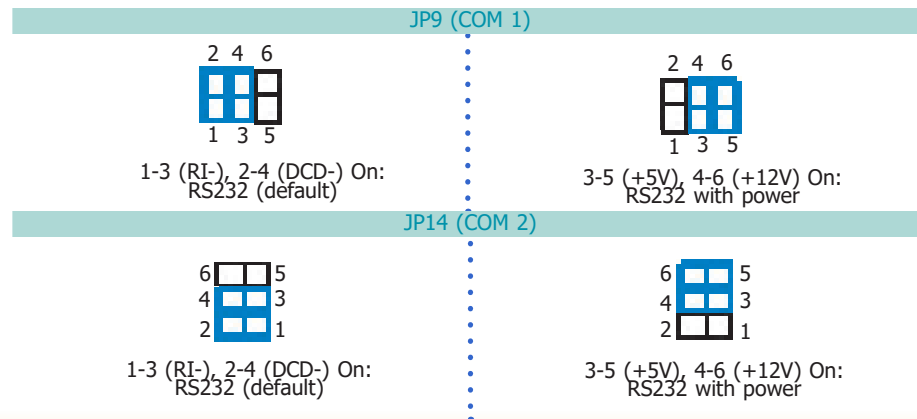

USB Power Select

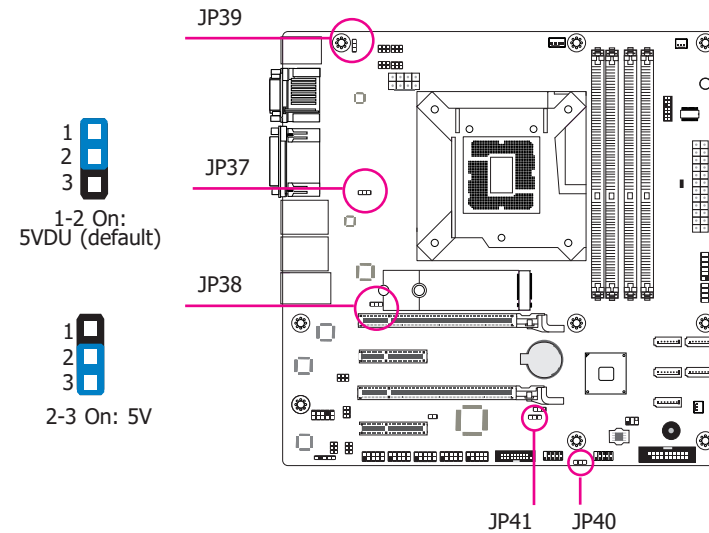

The power of the USB connectors' voltage buses can be configured to either 5VDU or 5V. The jumpers are located as illustrated above and correspond to each USB port number as listed below.

JP number	USB Port
JP37	USB 1/2 (USB 3.0)
JP38	USB 3/4 (USB 3.0)
JP39	USB 5/6 (USB 2.0)
JP40	USB 7/8/9/10 (USB 2.0)
JP41	USB 5/6 (USB 3.0)

Rear Panel I/O Ports

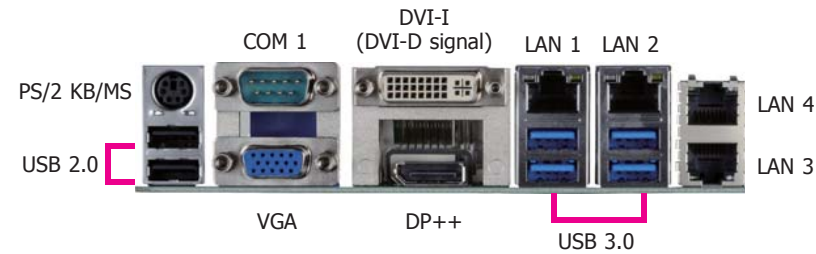

The rear panel I/O ports consist of the following:

- 1 PS/2 Keyboard/Mouse port
- 2 USB 2.0 ports
- 1 Serial COM port
- 1 VGA port
- 1 DVI-I (DVI-D signal) port
- 1 DP++ port
- 4 RJ45 LAN ports
- 4 USB 3.0 ports

PS/2 Keyboard/Mouse Port

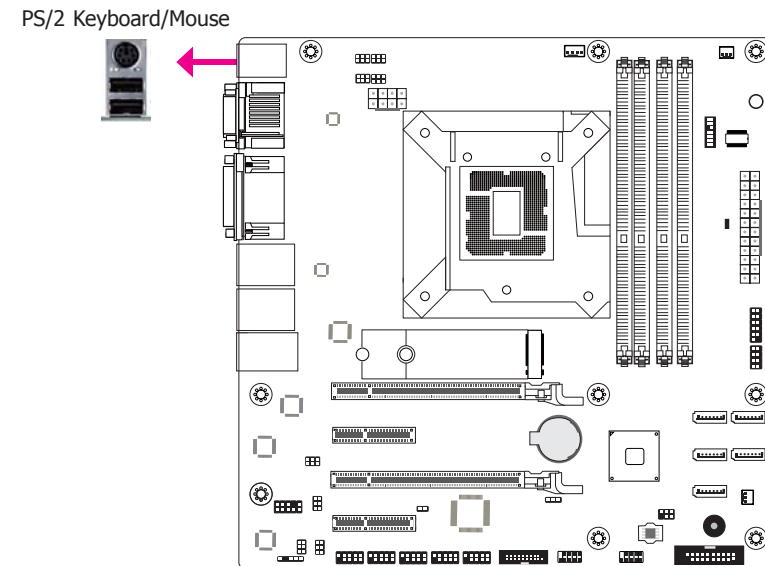

This rear I/O port is used to connect a PS/2 mouse and a PS/2 keyboard. The PS/2 mouse port uses IRQ12.

Wake-On-PS/2 Keyboard/Mouse

The Wake-On-PS/2 Keyboard/Mouse function allows you to use the PS/2 keyboard or PS/2 mouse to power-on the system. To use this function:

• BIOS Setting

Configure the wake-up function of PS/2 keyboard/mouse in the Advanced menu ("ACPI Configuration" submenu) of the BIOS. Refer to the chapter 3 for more information.



Important:

The +5V_standby power source of your power supply must support $\geq 720\text{mA}$.

COM (Serial) Ports

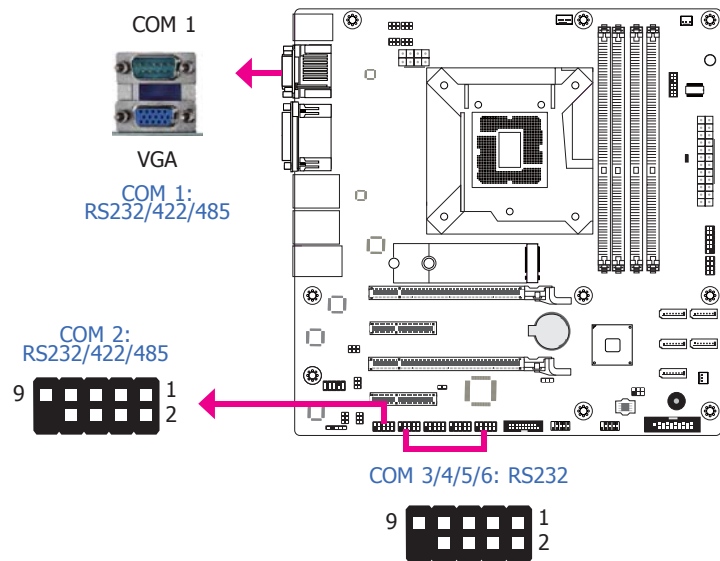

COM 3 to COM 6

Pin	Pin Assignment
1	DCD-
2	RD
3	TD
4	DTR-
5	GND
6	DSR-
7	RTS-
8	CTS-
9	RI-

The pin functions of COM 1 port will vary according to setting of JP7, JP8, JP9 and JP10. Refer to "COM1/COM2 RS232/422/485 Select" and "COM1/COM2 RS232/Power Select" in this chapter for more information.

The pin functions of COM 2 port will vary according to setting of JP11, JP12, JP13 and JP14. Refer to "COM1/COM2 RS232/422/485 Select" and "COM1/COM2 RS232/Power Select" in this chapter for more information.

COM 3 to COM 6 are fixed at RS232. The pin functions are listed at right.

The serial ports are asynchronous communication ports with 16C550A-compatible UARTs that can be used with modems, serial printers, remote display terminals, and other serial devices.

Connecting External Serial Ports

Your COM port may come mounted on a card-edge bracket. Install the card-edge bracket to an available slot at the rear of the system chassis then insert the serial port cable to the COM connector. Make sure the colored stripe on the ribbon cable is aligned with pin 1 of the COM connector.

BIOS Setting

Configure the serial COM ports in the Advanced menu ("SIO NUVOTON6106D" submenu) of the BIOS. Refer to the chapter 3 for more information.

Graphics Interfaces

The display ports consist of the following:

- 1 VGA port
- 1 DVI-I (DVI-D signal) port
- 1 DP++ port

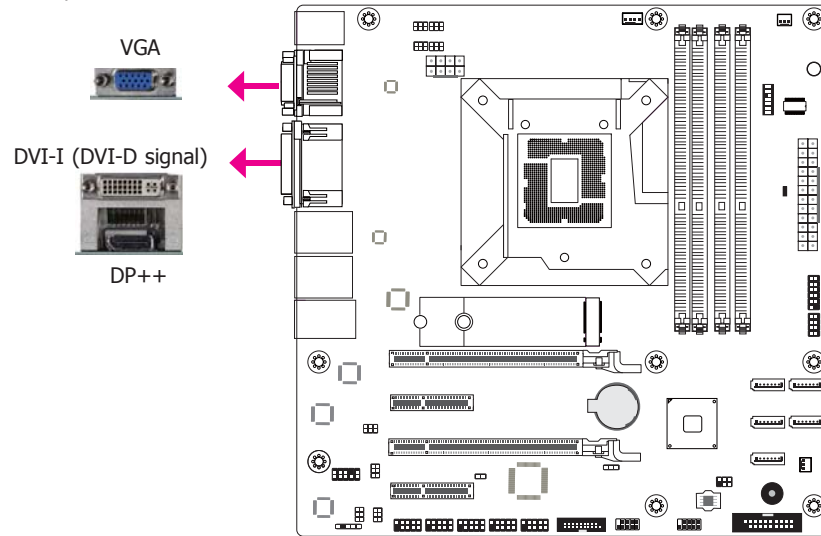

VGA Port

The VGA port is used for connecting a VGA monitor. Connect the monitor's 15-pin D-shell cable connector to the VGA port. After you plug the monitor's cable connector into the VGA port, gently tighten the cable screws to hold the connector in place.

DVI-I (DVI-D Signal) Port

The DVI-I port is used to connect a LCD monitor. This port supports DVI-D signal only. Connect the display device's cable connector to the DVI-I port. After plugging the cable connector into the port, gently tighten the cable screws to hold the connector in place.

DP++ Port

The DP++ port which carries both digital audio and video signals is used to connect a LCD monitor or a digital TV that has the DP++ port.

BIOS Setting

Configure the display devices in the Advanced menu ("Video Configuration" submenu) of the BIOS. Refer to the chapter 3 for more information.

Driver Installation

Install the graphics driver. Refer to the chapter 4 for more information.

RJ45 LAN Ports

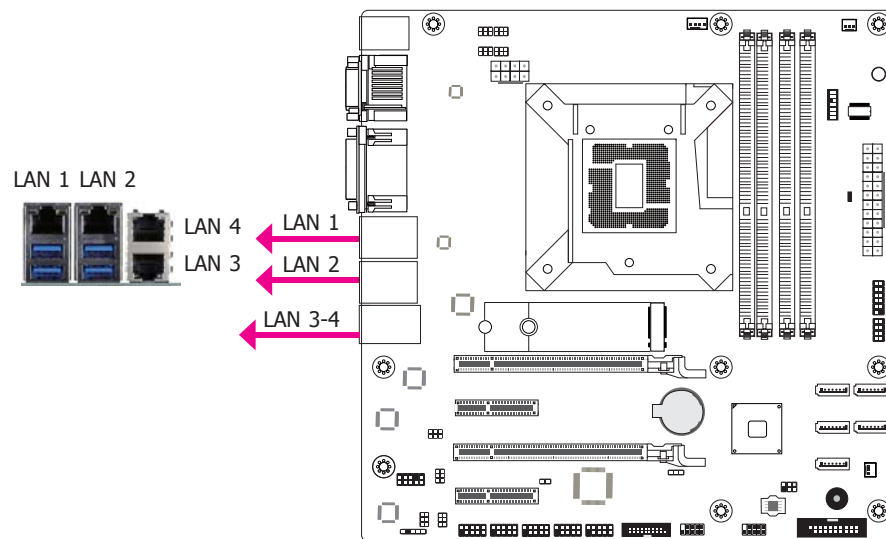

Features

- 3 Intel® I211AT PCIe
- 1 Intel® I219LM PCIe with iAMT11.0

The LAN ports allow the system board to connect to a local area network by means of a network hub.

BIOS Setting

Configure the onboard LAN ports in the Advanced menu (“ACPI Configuration” submenu) of the BIOS. Refer to the chapter 3 for more information.

Driver Installation

Install the LAN drivers. Refer to the chapter 4 for more information.

USB Ports

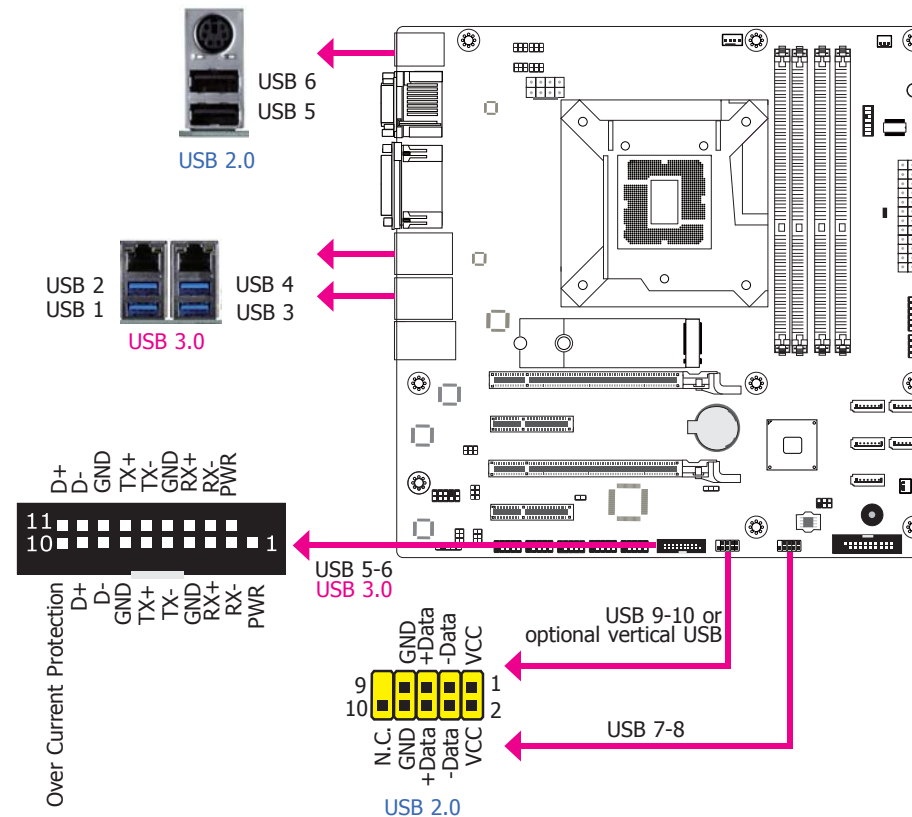

The USB device allows data exchange between your computer and a wide range of simultaneously accessible external Plug and Play peripherals.

The system board is equipped with 2 onboard USB 2.0 ports (USB 5-6) and 4 onboard USB 3.0 ports (USB 1-2/3-4). The 10-pin connectors allow you to connect 4 additional USB 2.0 ports (USB 7-8/9-10). The 20-pin connector allows you to connect 2 additional USB 3.0 ports (USB 5-6). The additional USB ports may be mounted on a card-edge bracket. Install the card-edge bracket to an available slot at the rear of the system chassis and then insert the USB port cables to a connector.

BIOS Setting

Configure these onboard USB devices in the Advanced menu (“USB Configuration” submenu) of the BIOS. Refer to the chapter 3 for more information.

Driver Installation

You may need to install the proper drivers in your system operation to use the USB device. Refer to your operating system's manual or documentation for more information.

Wake-On-USB Keyboard/Mouse

The Wake-On-USB Keyboard/Mouse function allows you to use a USB keyboard or USB mouse to wake up a system from the S3 (STR - Suspend To RAM) state.



Important:

If you are using the Wake-On-USB Keyboard/Mouse function for 2 USB ports, the +5V_standby power source of your power supply must support $\geq 1.5A$. For 3 or more USB ports, the +5V_standby power source of your power supply must support $\geq 2A$.

Audio

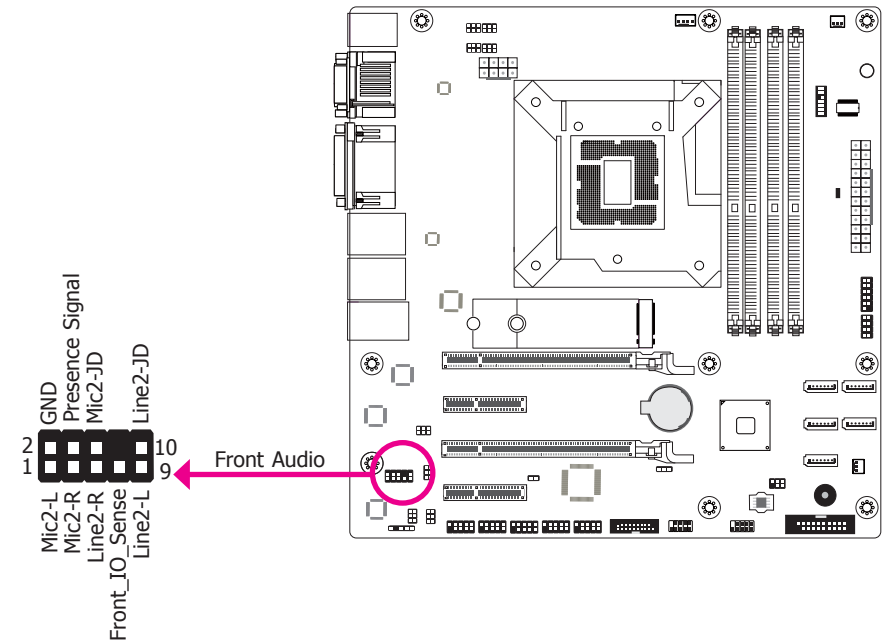

Front Audio

The front audio connector allows you to connect to the line-out and mic-in jacks that are at the front panel of your system.

Driver Installation

Install the audio driver. Refer to the chapter 4 for more information.

I/O Connectors

SATA (Serial ATA) Connectors

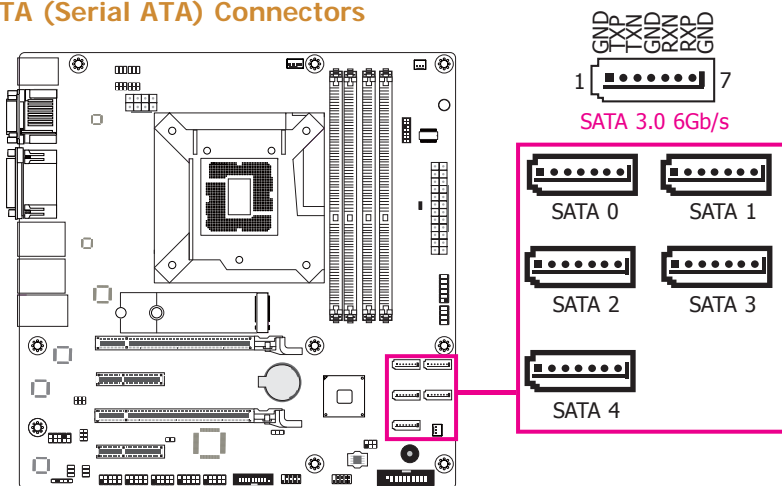

Features

- 5 Serial ATA 3.0 ports with data transfer rate up to 6Gb/s
- Integrated Advanced Host Controller Interface (AHCI) controller
- Supports Intel® Smart Response Technology
- Supports RAID 0, RAID 1, RAID 5, RAID 10

The Serial ATA connectors are used to connect Serial ATA devices. Connect one end of the Serial ATA data cable to a SATA connector and the other end to your Serial ATA device.

BIOS Setting

Configure the Serial ATA drives in the Advanced menu ("SATA Configuration" submenu) of the BIOS. Refer to the chapter 3 for more information.

Digital I/O Connector

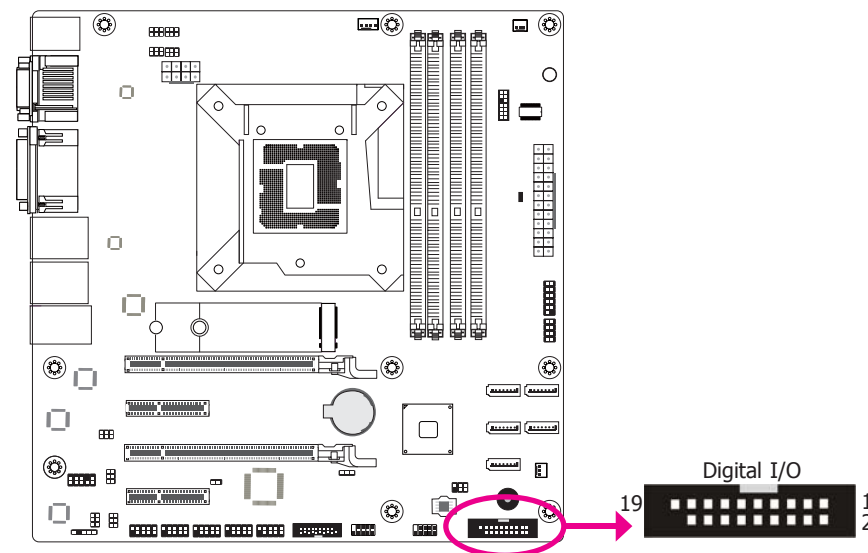

The 8-bit Digital I/O connector provides powering-on function to external devices that are connected to these connectors. The pin functions of the 8-bit digital I/O connector are listed below.

Digital I/O Connector

Pin	Pin Assignment	Pin	Pin Assignment
1	GND	2	+12V
3	DIO7	4	+12V
5	DIO6	6	GND
7	DIO5	8	+5V
9	DIO4	10	+5V
11	DIO3	12	GND
13	DIO2	14	+5V _{DU}
15	DIO1	16	+5V _{DU}
17	DIO0	18	GND
19	GND		

Cooling Fan Connectors

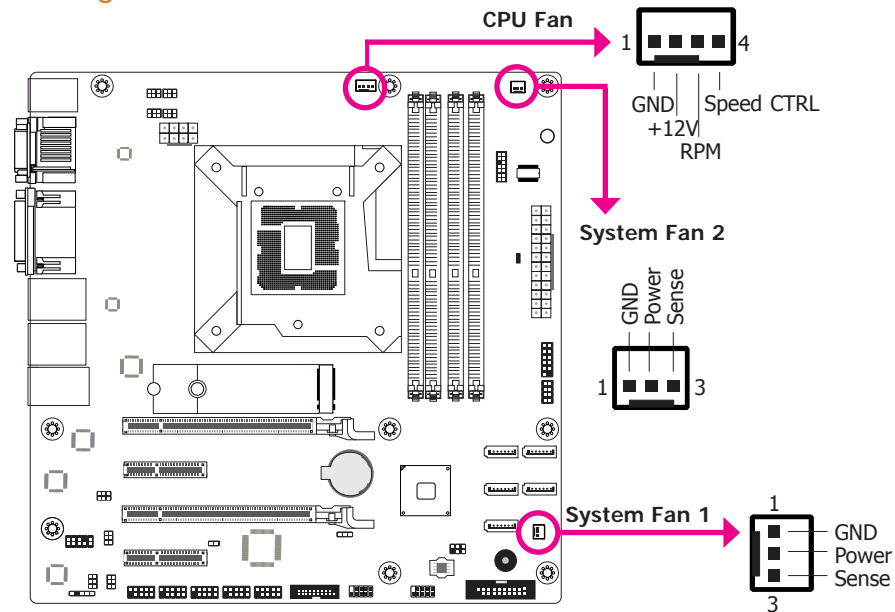

These fan connectors are used to connect cooling fans. The cooling fans will provide adequate airflow throughout the chassis to prevent overheating the CPU and system board components.

BIOS Setting

The Advanced menu ("SIO NUVOTON6106D" submenu) of the BIOS will display the current speed of the cooling fans. Refer to chapter 3 for more information.

Power Connectors

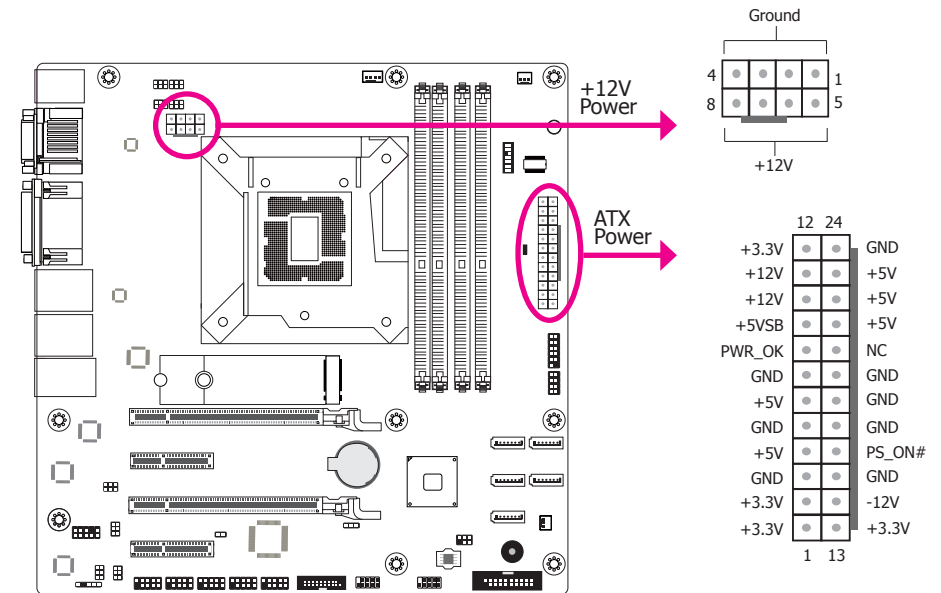

Use a power supply that complies with the ATX12V Power Supply Design Guide Version 1.1. An ATX12V power supply unit has a standard 24-pin ATX main power connector that must be inserted into the 24-pin connector. The 8-pin +12V power connector enables the delivery of more +12VDC current to the processor's Voltage Regulator Module (VRM).

The power connectors from the power supply unit are designed to fit the 24-pin and 8-pin connectors in only one orientation. Make sure to find the proper orientation before plugging the connectors.

The system board requires a minimum of 300 Watt power supply to operate. Your system configuration (CPU power, amount of memory, add-in cards, peripherals, etc.) may exceed the minimum power requirement. To ensure that adequate power is provided, we strongly recommend that you use a minimum of 400 Watt (or greater) power supply.



Important:

Insufficient power supplied to the system may result in instability or the add-in boards and peripherals not functioning properly. Calculating the system's approximate power usage is important to ensure that the power supply meets the system's consumption requirements.

Chassis Intrusion Connector

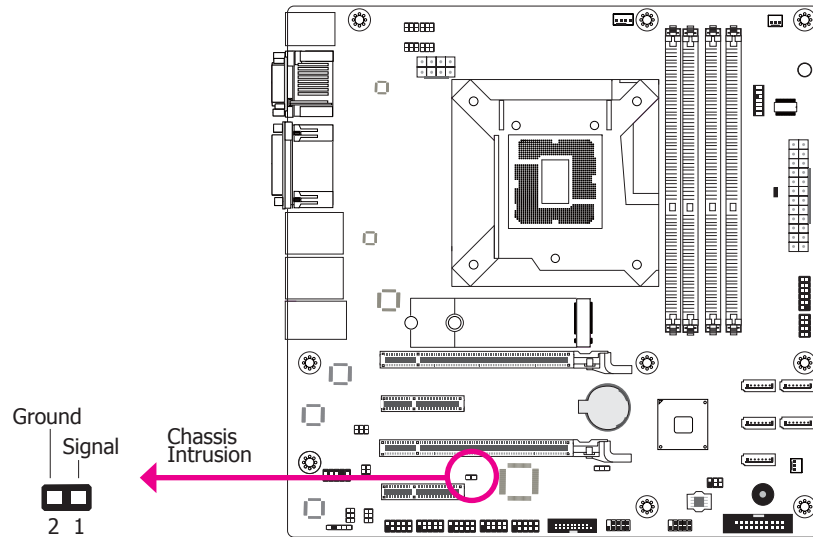

The board supports the chassis intrusion detection function. Connect the chassis intrusion sensor cable from the chassis to this connector. When the system's power is on and a chassis intrusion occurred, an alarm will sound. When the system's power is off and a chassis intrusion occurred, the alarm will sound only when the system restarts.

BIOS Setting

Configure the chassis intrusion detection function in the Advanced menu ("SIO NUVO-TON6106D Configuration" submenu) of the BIOS. Refer to the chapter 3 for more information.

Front Panel Connector

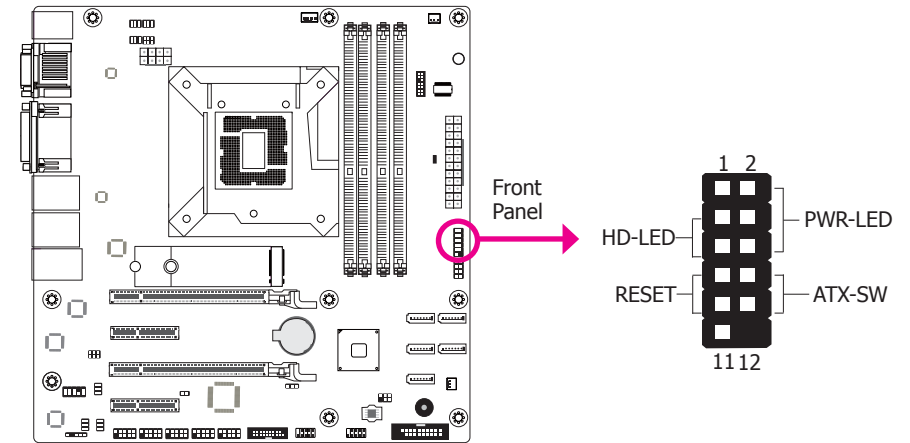

HD-LED - Hard Drive LED

This LED will light when the hard drive is being accessed.

RESET - Reset Switch

This switch allows you to reboot without having to power off the system.

PWR-LED - Power/Standby LED

When the system's power is on, this LED will light. When the system is in the S1 (POS - Power On Suspend) state, it will blink every second. When the system is in the S3 (STR - Suspend To RAM) state, it will blink every 4 seconds.

ATX-SW - Power Switch

This switch is used to power on or off the system.

	Pin	Pin Assignment		Pin	Pin Assignment
HD-LED	3	HDD Power	PWR-LED	2	LED Power
	5	Signal		4	LED Power
RESET	7	Ground	ATX-SW	6	Signal
	9	RST Signal		8	Ground
	11	N.C.		10	Signal

LAN LED Connector

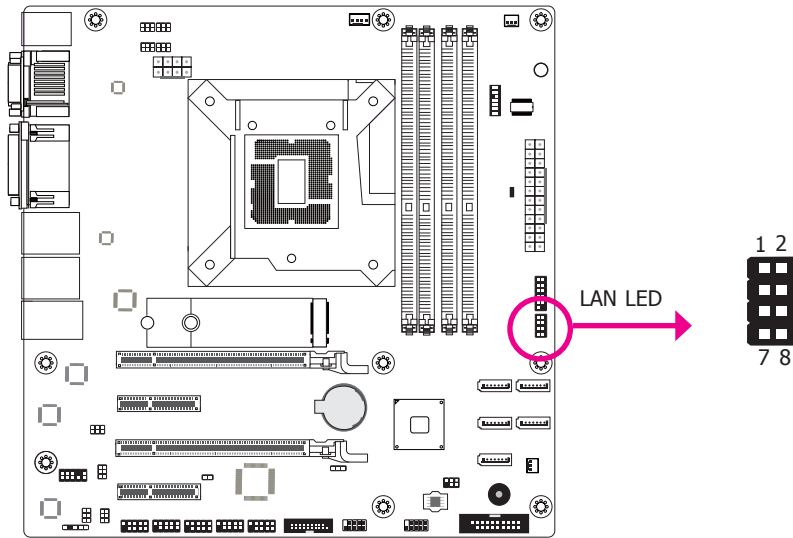

The LAN LED connector is used to detect the connection state of RJ45 LAN ports when the connection is made to an active network via a cable. The pin functions of the LAN LED connector are listed below.

Pin	Pin Assignment	Pin	Pin Assignment
1	GBE_LED_1000-	2	GBE_LED_100-
3	GBE_LED_LINK_ACT-	4	3V3DU
5	LINK_1000_2	6	LINK_100_2
7	LINK_ACTIVITY_2	8	3V3DU

S/PDIF Connector

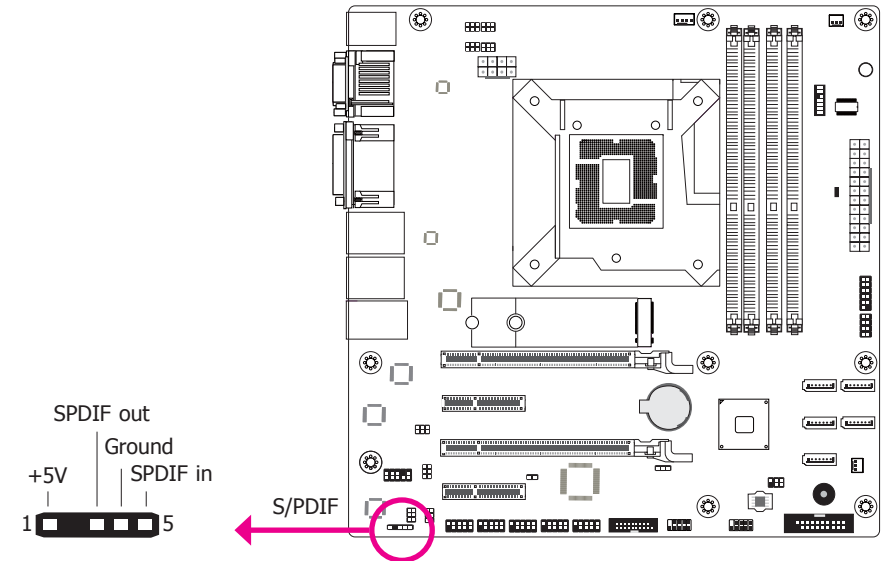

The S/PDIF connector is used to connect an external S/PDIF port. Your S/PDIF port may be mounted on a card-edge bracket. Install the card-edge bracket to an available slot at the rear of the system chassis then connect the audio cable to the S/PDIF connector. Make sure pin 1 of the audio cable is aligned with pin 1 of the S/PDIF connector.

SMBus Connector

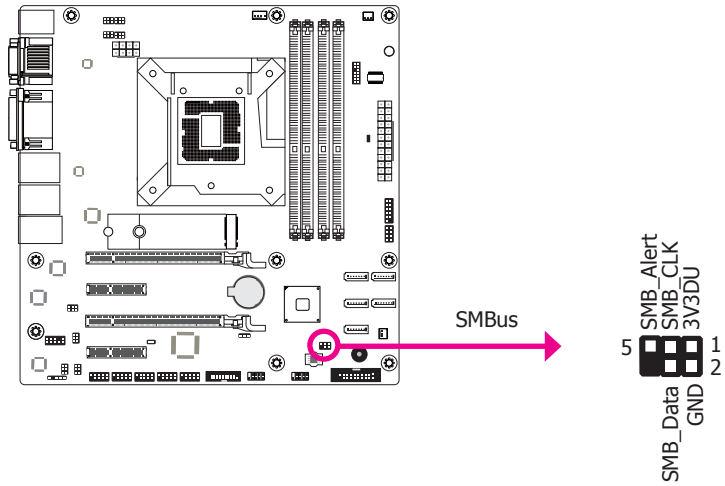

The SMBus (System Management Bus) connector is used to connect SMBus devices. It is a multiple device bus that allows multiple chips to connect to the same bus and enable each one to act as a master by initiating data transfer.

Standby Power LED

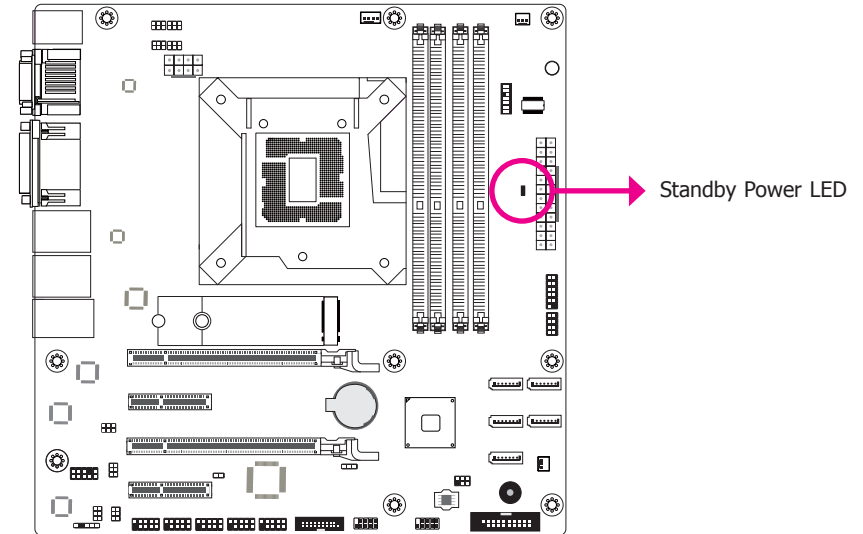

This LED will lit red when the system is in the standby mode. It indicates that there is power on the system board. Power-off the PC and then unplug the power cord prior to installing any devices. Failure to do so will cause severe damage to the motherboard and components.

LPC Connector

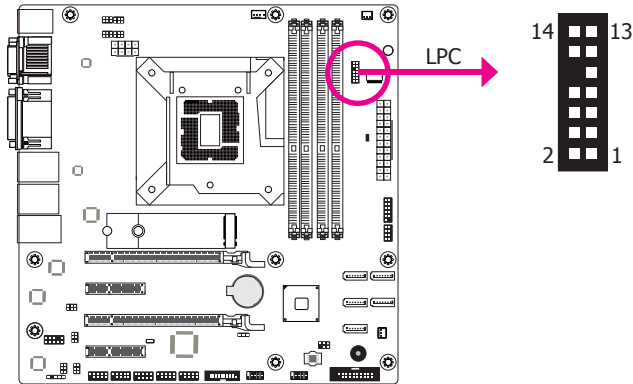

The Low Pin Count Interface was defined by Intel® Corporation to facilitate the industry's transition towards legacy free systems. It allows the integration of low-bandwidth legacy I/O components within the system, which are typically provided by a Super I/O controller. Furthermore, it can be used to interface firmware hubs, Trusted Platform Module (TPM) devices and embedded controller solutions. Data transfer on the LPC bus is implemented over a 4 bit serialized data interface, which uses a 33MHz LPC bus clock. For more information about LPC bus refer to the Intel® Low Pin Count Interface Specification Revision 1.1'. The table below indicates the pin functions of the LPC connector.

Pin	Pin Assignment	Pin	Pin Assignment
1	L_CLK	2	L_AD1
3	L_RST#	4	L_AD0
5	L_FRAME#	6	3V3
7	L_AD3	8	GND
9	L_AD2	10	---
11	INT_SERIRQ	12	GND
13	5VSB	14	5V

Connecting the EXT-RS232/RS485 Card to the Motherboard

With DFI's proprietary technology, KD331-C236/Q170 supports two extension modules for additional four COM ports. The EXT-RS232/RS485 card is connected to KD331-C236/Q170 via the LPC connector. The illustrations below guide you how to connect the extension module to the motherboard.

Note: The system board used in the following illustrations may not resemble the actual one. These illustrations are for reference only.

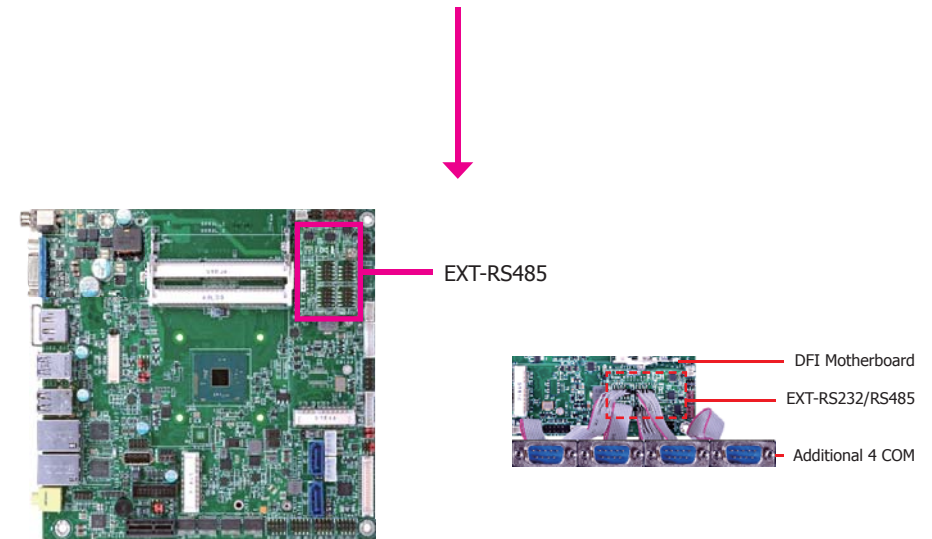
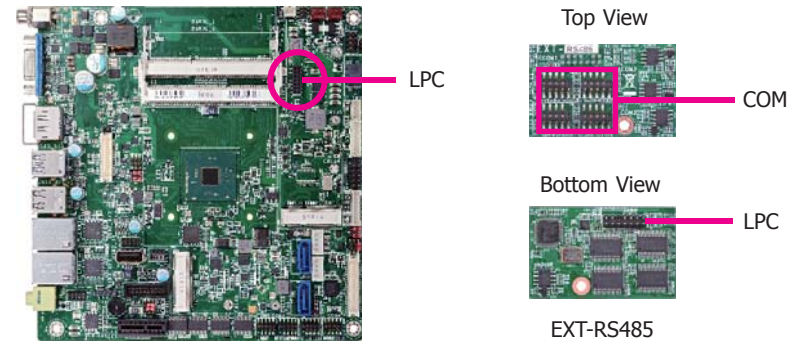

Expansion Slots

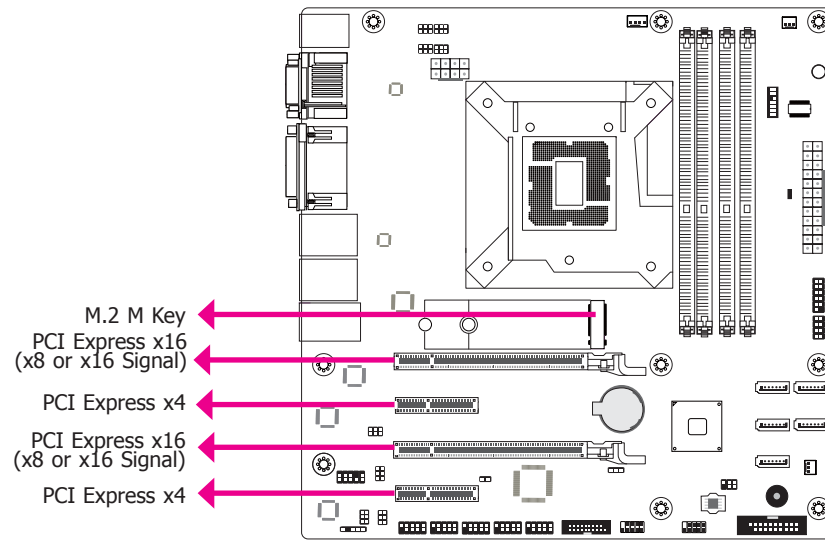

M.2 (M Key) Socket

The M.2 socket is the Next Generation Form Factor (NGFF) which is designed to support multiple modules and make the M.2 more suitable in application for solid-state storage.

PCI Express x16 Slot

Install PCI Express x16 graphics card, that comply to the PCI Express specifications, into the PCI Express x16 slot. To install a graphics card into the x16 slot, align the graphics card above the slot then press it down firmly until it is completely seated in the slot. The retaining clip of the slot will automatically hold the graphics card in place.

PCI Express x4 Slot

Install PCI Express cards such as network cards or other cards that comply to the PCI Express specifications into the PCI Express x4 slot.

Battery

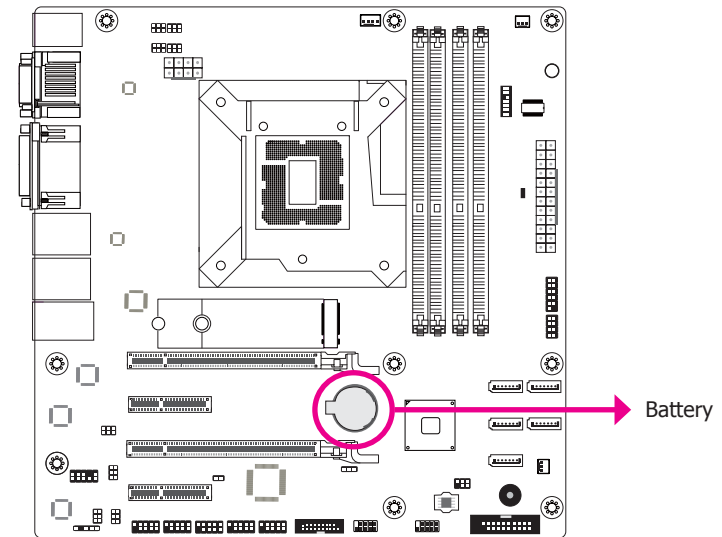

The lithium ion battery powers the real-time clock and CMOS memory. It is an auxiliary source of power when the main power is shut off.

Safety Measures

- Danger of explosion if battery incorrectly replaced.
- Replace only with the same or equivalent type recommended by the manufacturer.
- Dispose of used batteries according to local ordinance.

Chapter 3 - BIOS Setup

Overview

The BIOS is a program that takes care of the basic level of communication between the CPU and peripherals. It contains codes for various advanced features found in this system board. The BIOS allows you to configure the system and save the configuration in a battery-backed CMOS so that the data retains even when the power is off. In general, the information stored in the CMOS RAM of the EEPROM will stay unchanged unless a configuration change has been made such as a hard drive replaced or a device added.

It is possible that the CMOS battery will fail causing CMOS data loss. If this happens, you need to install a new CMOS battery and reconfigure the BIOS settings.



Note:

The BIOS is constantly updated to improve the performance of the system board; therefore the BIOS screens in this chapter may not appear the same as the actual one. These screens are for reference purpose only.

Default Configuration

Most of the configuration settings are either predefined according to the Load Optimal Defaults settings which are stored in the BIOS or are automatically detected and configured without requiring any actions. There are a few settings that you may need to change depending on your system configuration.

Entering the BIOS Setup Utility

The BIOS Setup Utility can only be operated from the keyboard and all commands are keyboard commands. The commands are available at the right side of each setup screen.

The BIOS Setup Utility does not require an operating system to run. After you power up the system, the BIOS message appears on the screen and the memory count begins. After the memory test, the message "Press DEL to run setup" will appear on the screen. If the message disappears before you respond, restart the system or press the "Reset" button. You may also restart the system by pressing the <Ctrl> <Alt> and keys simultaneously.

Legends

Keys	Function
Right and Left arrows	Moves the highlight left or right to select a menu.
Up and Down arrows	Moves the highlight up or down between submenu or fields.
<Esc>	Exit to the BIOS Setup Utility.
+ / <F5> (plus key)	Scrolls forward through the values or options of the highlighted field.
- / <F6> (minus key)	Scrolls backward through the values or options of the highlighted field.
Tab	Select a field.
<F1>	Displays general help
<F9>	Optimized defaults
<F10>	Saves and resets the setup program.
<Enter>	Press <Enter> to enter the highlighted submenu.

Scroll Bar

When a scroll bar appears to the right of the setup screen, it indicates that there are more available fields not shown on the screen. Use the up and down arrow keys to scroll through all the available fields.

Submenu

When "►" appears on the left of a particular field, it indicates that a submenu which contains additional options are available for that field. To display the submenu, move the highlight to that field and press <Enter>.

Insyde BIOS Setup Utility

Main

The Main menu is the first screen that you will see when you enter the BIOS Setup Utility.

InsydeH2O Setup Utility		Rev. 5.0
Main	Advanced	Security Boot Exit
Project Name	KD331	This is the help for the hour, minute, second field. Valid range is from 0 to 23, 0 to 59, 0 to 59. INCREASE/REDUCE: +/-.
BIOS Version	B183.05A	
Supported Processor	Intel 6th and 7th Generation CPU	
Processor Type	Intel(R) Core(TM) i5-7500T CPU @ 2.70GHz	
CPUID	0x906E9 (KABYLAKE DT HALO)	
CPU Speed	2700 MHz	
CPU Stepping	09 (KBL B0/S0/M0 Stepping)	
L1 Data Cache	32 KB	
L1 Instruction Cache	32 KB	
L2 Cache	256 KB	
L3 Cache	6144 KB	
Number Of Processors	4 Core(s) / 4 Thread(s)	
Microcode Rev	0000005E	
Total Memory	4096 MB	
System Memory Speed	2400 MHz	
DIMM 0	[Not Installed]	
DIMM 1	[Not Installed]	
DIMM 2	4096 MB	
DIMM 3	[Not Installed]	
PCH Rev / SKU	31 (D1 Stepping) / SKL PCH-H C236	
Intel ME Version / SKU	11.8.50.3399 / CORPORATE	
System Time	[23:38:29]	
System Date	[06/23/2015]	

F1 Help ↑/↓ Select Item F5/F6 Change Values F9 Setup Defaults
Esc Exit ←/→ Select Item Enter Select ► SubMenu F10 Save and Exit

System Time

The time format is <hour>, <minute>, <second>. The time is based on the 24-hour military-time clock. For example, 1 p.m. is 13:00:00. Hour displays hours from 00 to 23. Minute displays minutes from 00 to 59. Second displays seconds from 00 to 59.

System Date

The date format is <month>, <date>, <year>. Month displays the month, from 01 to 12. Date displays the date, from 01 to 31. Year displays the year, from 2000 to 2099.

Advanced

The Advanced menu allows you to configure your system for basic operation. Some entries are defaults required by the system board, while others, if enabled, will improve the performance of your system or let you set some features according to your preference.



Important:

Setting incorrect field values may cause the system to malfunction.

InsydeH2O Setup Utility		Rev. 5.0
Main	Advanced	Security Boot Exit
▶ACPI Configuration		ACPI Configuration Setting
▶CPU Configuration		
▶Video Configuration		
▶Audio Configuration		
▶SATA Configuration		
▶USB Configuration		
▶PCI Express Configuration		
▶ME Configuration		
▶Active Management Technology Support		
▶MEBx Configuration		
▶UEFI Device Manager		
▶SIO NUVOTON6106D		
▶Console Redirection		

F1 Help ↑/↓ Select Item F5/F6 Change Values F9 Setup Defaults
Esc Exit ←/→ Select Item Enter Select ► SubMenu F10 Save and Exit

ACPI Configuration

This section is used to configure the system ACPI parameters.

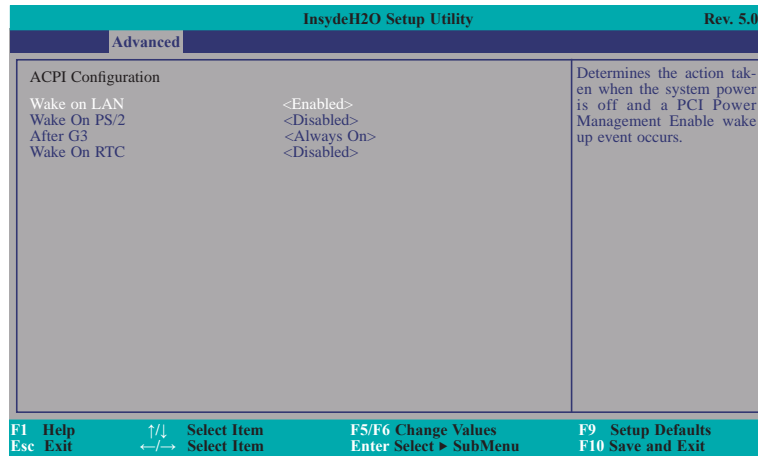

Wake on LAN

This field is used to enable or disable the LAN signal to wake up the system.

Wake On PS/2

This field is used to enable or disable the PS/2 device to wake up the system.

After G3

This field is to specify what state to go when power is re-applied after a power failure (G3 state).

Always On The system working state.

Always Off Off, except for trickle current to devices such as the power button.

Wake On RTC

Automatically power the system on at a particular time every day from the Real-time clock battery.

Wake up time

When Wake On RTC is set to enabled, specify the wake up time of the day: <hour> (00~23), <minute> (00~59), <second> (00~59).



Note:

Under Dual Boot Type or UEFI Boot Type mode, if Quiet Boot is set to enabled, BGRT Logo field will appear for configuration. Refer to the Boot menu for more information.

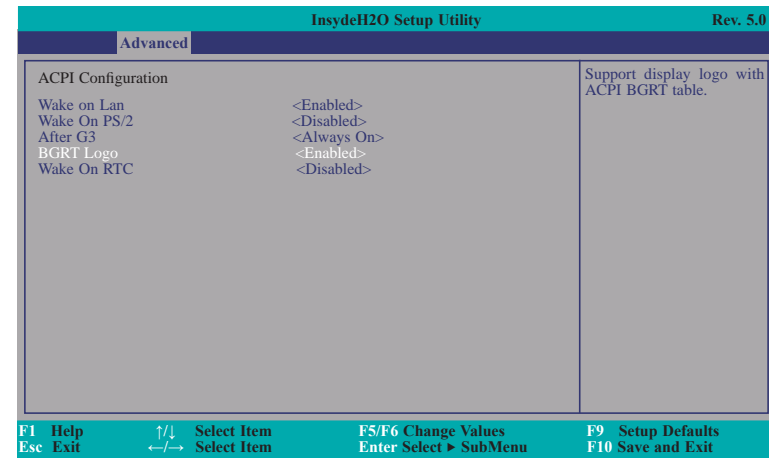

BGRT Logo

This field is used to enable or disable to support display logo with ACPI BGRT table.

CPU Configuration

This section is used to configure the CPU.

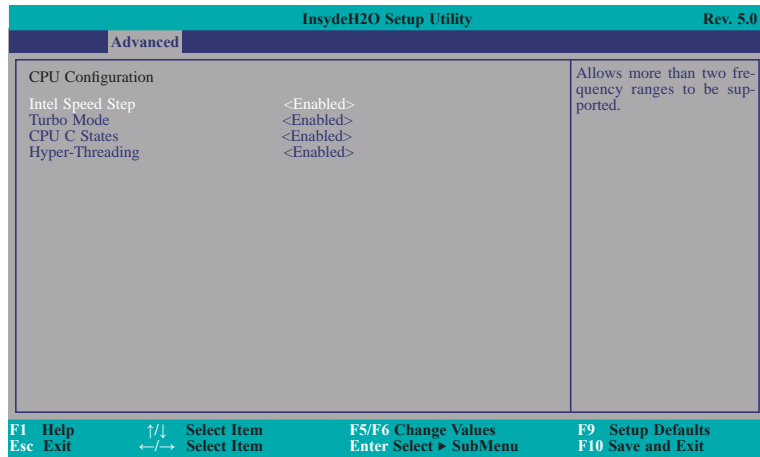

Intel Speed Step

This field is used to enable or disable the Intel Enhanced SpeedStep Technology. If enabled, Turbo Mode will appear for configuration.

Turbo Mode

Enable or disable the turbo mode.

CPU C States

Enable or disable the CPU Power Management.

Hyper-Threading

Enables this field for Windows XP and Linux which are optimized for Hyper-Threading technology. Select disabled for other OSes not optimized for Hyper-Threading technology. When disabled, only one thread per enabled core is enabled.

Video Configuration

This section configures the video settings.

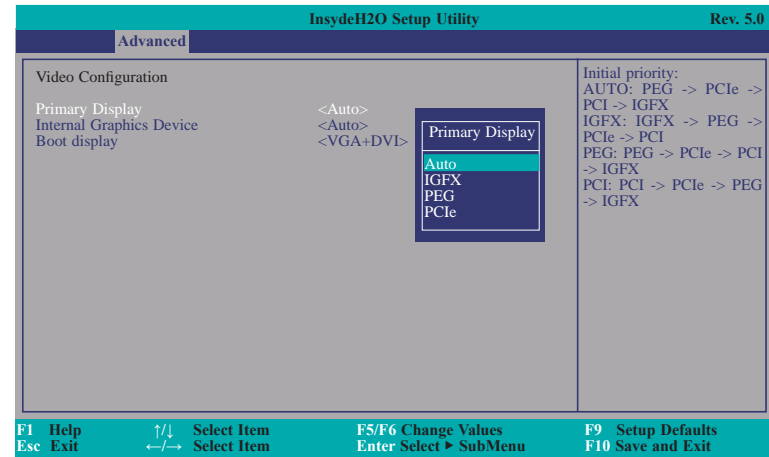

Primary Display

Set the initial priority.

Internal Graphics Device

Keep IGFX enabled or disabled based on the setup options.

Boot display

Set the display device combination.



Note:

To control "Primary Display" & "Boot Display", first go to "Boot" menu and select different "Boot Type".

Boot Type : Legacy Boot Type -> Hide Primary Display & Show Boot Display

Boot Type : UEFI Boot Type -> Show Primary Display & Hide Boot Display

Boot Type : Dual Boot Type -> Show Primary Display & Show Boot Display

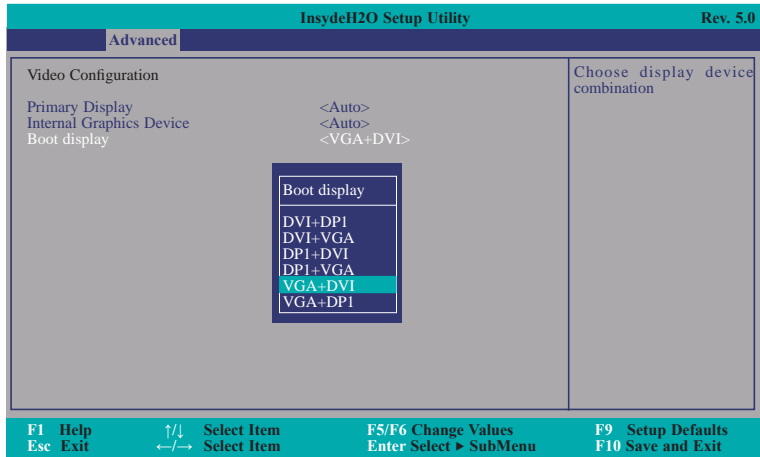

Audio Configuration

This section is used to configure the audio settings.

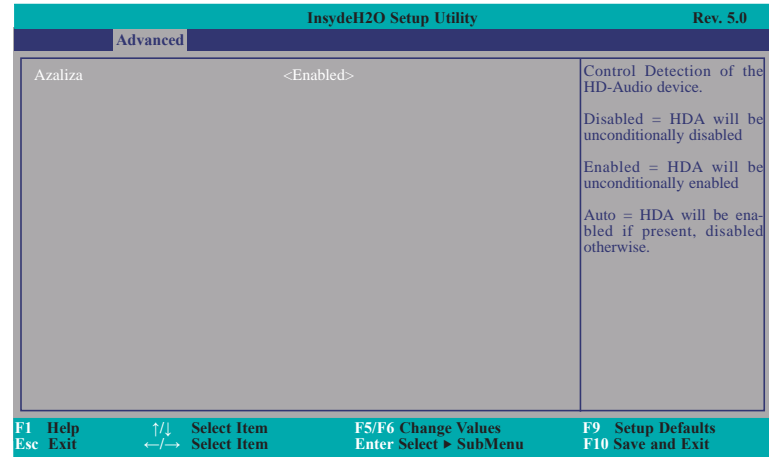

Azalza

Control the detection of the Azalza device.

Disabled

HDA will be unconditionally disabled.

Enabled

HDA will be unconditionally enabled.

Auto

HDA will be enabled if present, disabled otherwise.

SATA Configuration (KD331-Q170)

This section is designed to select the SATA controller and the type of hard disk drive which are installed in your system unit.

InsydeH2O Setup Utility		Rev. 5.0
Advanced		
SATA Controller(s)	<Enabled>	Enable/Disable SATA Device.
SATA Speed	<Auto>	
SATA Mode Selection	<AHCI>	
Serial ATA Port 0	[Not Installed]	
Port 0	<Enabled>	
Hot Plug	<Disabled>	
Serial ATA Port 1	[Not Installed]	
Port 1	<Enabled>	
Hot Plug	<Disabled>	
Serial ATA Port 2	[Not Installed]	
Port 2	<Enabled>	
Hot Plug	<Disabled>	
Serial ATA Port 3	[Not Installed]	
Port 3	<Enabled>	
Hot Plug	<Disabled>	
Serial ATA Port 4	[Not Installed]	
Port 4	<Enabled>	
Hot Plug	<Disabled>	
Serial ATA Port 5	[Not Installed]	
Port 5	<Enabled>	

F1 Help ↑/↓ Select Item F5/F6 Change Values F9 Setup Defaults
 Esc Exit ←/→ Select Item Enter Select ► SubMenu F10 Save and Exit

SATA Controller(s)

This field is used to enable or disable Serial ATA devices.

SATA Speed

This field is used to select SATA speed generation limit: Auto, Gen1, Gen2 or Gen3.

SATA Mode Selection

The mode selection determines how the SATA controller(s) operates.

AHCI Mode

This option allows the Serial ATA devices to use AHCI (Advanced Host Controller Interface).

Intel RST Premium Mode

This option allows you to create RAID or Intel Matrix Storage configuration on Serial ATA devices.

Serial ATA Port 0, 1, 2, 3, 4, 5 and Hot Plug

These fields are used to enable or disable the serial ATA port and its hot plug. Serial ATA Port 5 is used to configure SATA signal of M.2.

SATA Configuration (KD331-C236)

This section is designed to select the SATA controller and the type of hard disk drive which are installed in your system unit.

InsydeH2O Setup Utility		Rev. 5.0
Advanced		
SATA Controller(s)	<Enabled>	Enable/Disable SATA Device.
SATA Speed	<Auto>	
SATA Mode Selection	<AHCI>	
System Acceleration with Intel(R) Optane(TM) Memory	<Enabled>	
Serial ATA Port 0	[Not Installed]	
Port 0	<Enabled>	
Hot Plug	<Disabled>	
Serial ATA Port 1	[Not Installed]	
Port 1	<Enabled>	
Hot Plug	<Disabled>	
Serial ATA Port 2	[Not Installed]	
Port 2	<Enabled>	
Hot Plug	<Disabled>	
Serial ATA Port 3	[Not Installed]	
Port 3	<Enabled>	
Hot Plug	<Disabled>	
Serial ATA Port 4	[Not Installed]	
Port 4	<Enabled>	
Hot Plug	<Disabled>	
Serial ATA Port 5	[Not Installed]	
Port 5	<Enabled>	

F1 Help ↑/↓ Select Item F5/F6 Change Values F9 Setup Defaults
 Esc Exit ←/→ Select Item Enter Select ► SubMenu F10 Save and Exit

SATA Controller(s)

This field is used to enable or disable Serial ATA devices.

SATA Speed

This field is used to select SATA speed generation limit: Auto, Gen1, Gen2 or Gen3.

SATA Mode Selection

The mode selection determines how the SATA controller(s) operates.

AHCI Mode

This option allows the Serial ATA devices to use AHCI (Advanced Host Controller Interface).

Intel RST Premium With Intel Optane System Acceleration Mode

This option allows you to create RAID or Intel Rapid Storage configuration with Intel® Optane™ system acceleration on Serial ATA devices.

System Acceleration with Intel(R) Optane(TM) Memory

This field is used to enable or disable the system acceleration with Intel® Optane™ memory feature.

Serial ATA Port 0, 1, 2, 3, 4, 5 and Hot Plug

These fields are used to enable or disable the serial ATA port and its hot plug. Serial ATA Port 5 is used to configure SATA signal of M.2.

USB Configuration

This section is used to configure the parameters of the USB device.

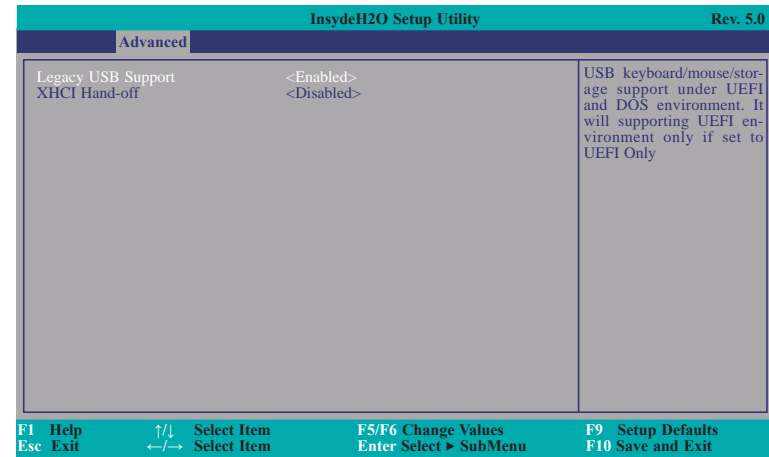

Legacy USB Support

Disabled

Disable USB keyboard/mouse/storage support under UEFI and DOS environment.

Enabled

Enable USB keyboard/mouse/storage support under UEFI and DOS environment.

UEFI Only

Enable USB keyboard/mouse/storage support under UEFI environment.

XHCI Hand-off

Enable or disable to clear XHCI controller ownership change SMI bit by BIOS.

PCI Express Configuration

This section configures settings relevant to PCI Express root ports.

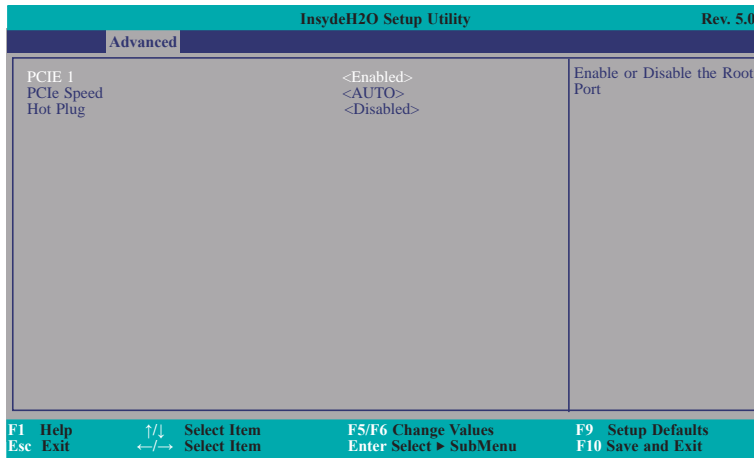
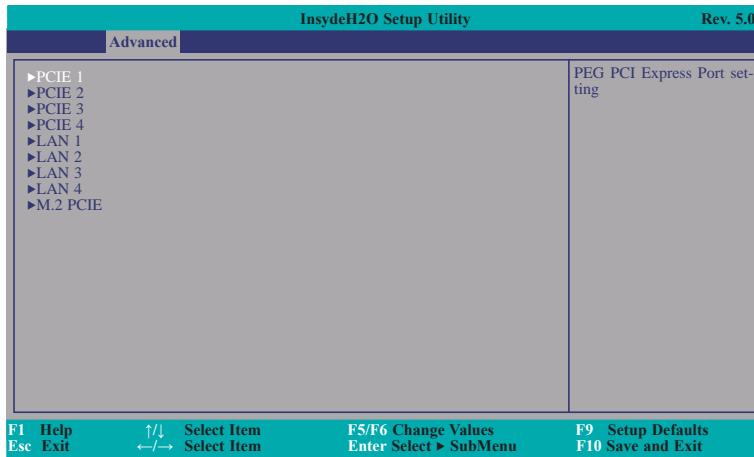

PCIE 1/3 and PCI Express Root Port 1/5/9/11/12/19/20

This field is used to enable or disable the PCI Express Root Port.

PCIe Speed

Select the speed of the PCI Express Root Port: Auto, Gen1, Gen2 or Gen3.

Hot Plug

This field is used to enable or disable the PCI Express Hot Plug.

LAN 1 to 4

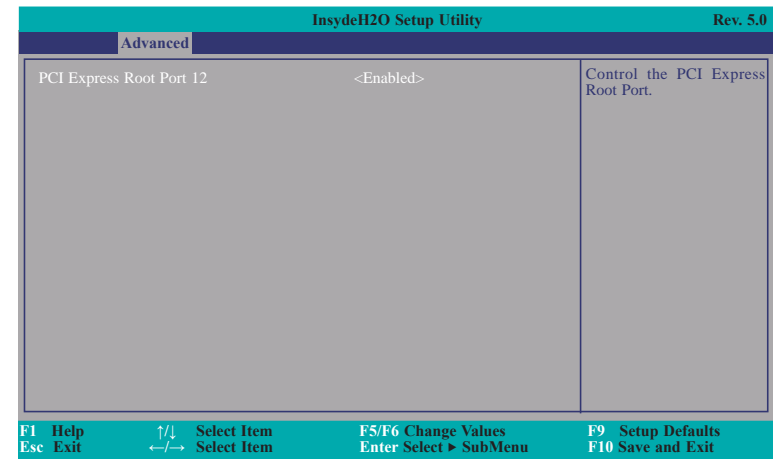

M.2 PCIE

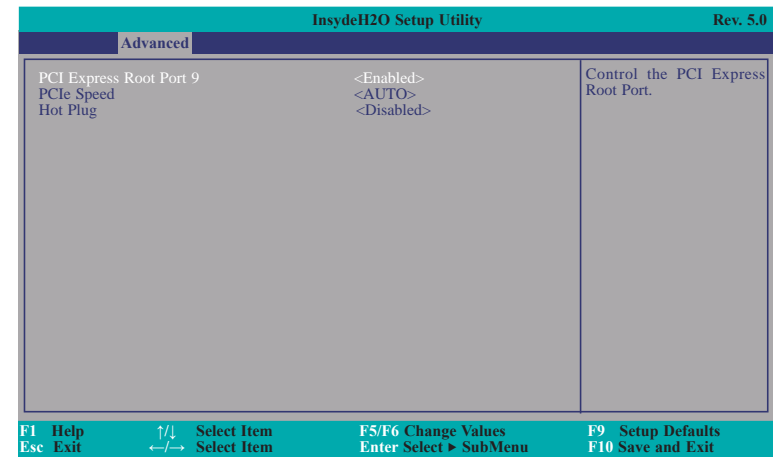

ME Configuration

This section configures settings relevant to flash ME region.

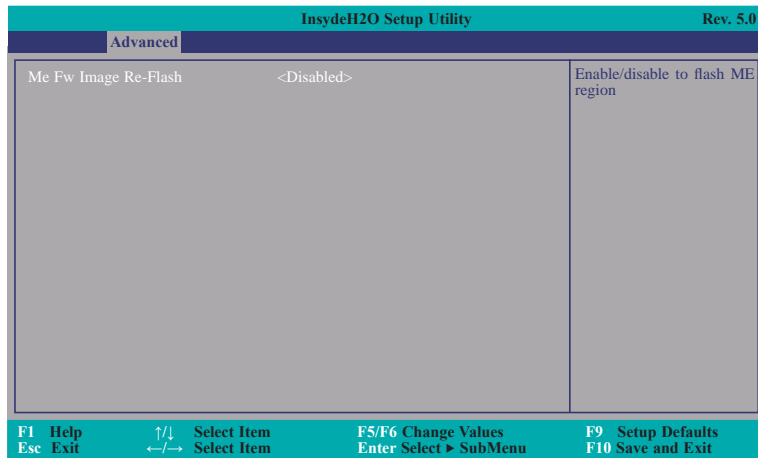

Me Fw Image Re-Flash

This field is used to enable or disable the flash ME region.

Active Management Technology Support

The section allows users to enable or disable the Intel® Active Management Technology (Intel® AMT) BIOS extension. Please refer to **Chapter 6** for more information.

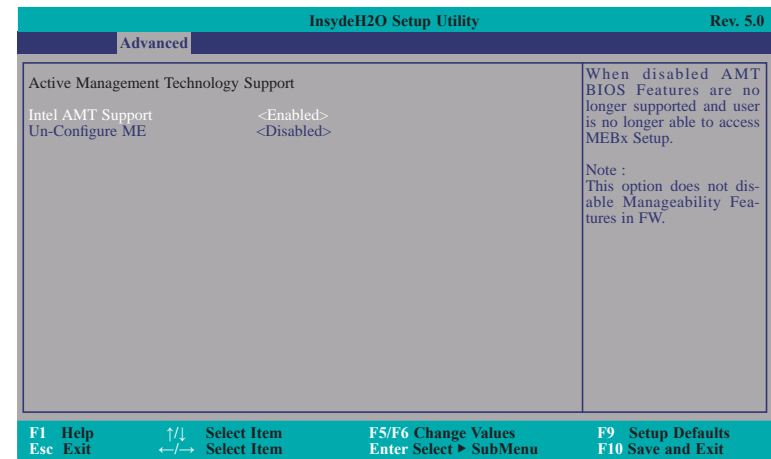

Intel AMT Support

This field is used to enable or disable Intel® Active Management Technology BIOS Extension.

Un-Configure ME

This field is used to enable or disable un-figuring ME without password.

MEBX Configuration

This section configures MEBX setting. Please refer to **Chapter 6** for more information.

UEFI Device Manager

The section configures UEFI device with option ROM, such as LAN card, etc.

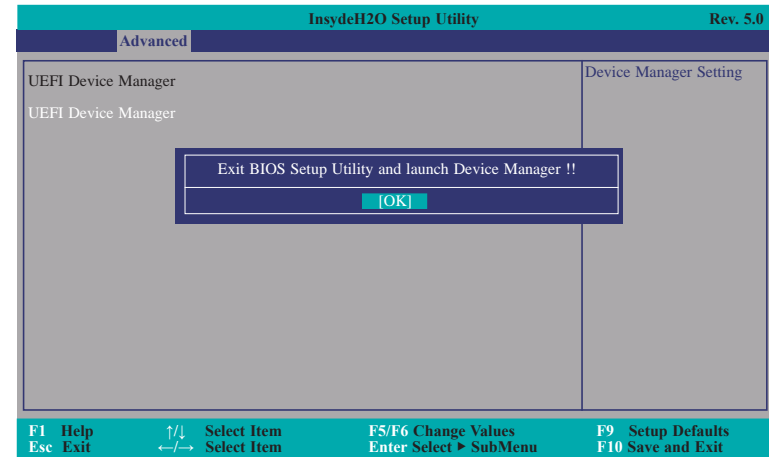

SIO NUVOTON6106D

This section configures the system super I/O chip parameters.

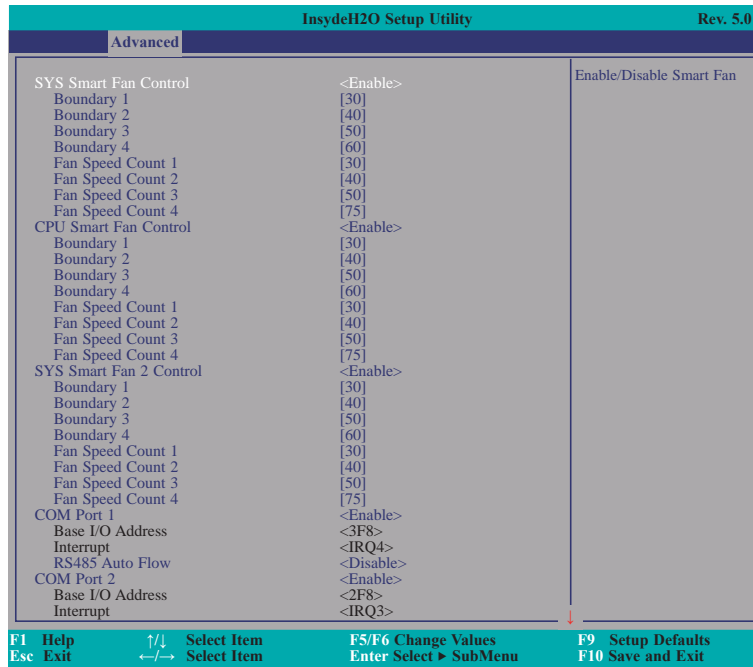
**Note:**

SYS Smart Fan Control, CPU Smart Fan Control, and SYS Smart Fan 2 Control can be switched to <Disable>. When they are disabled, it will enable "Fix Fan Speed Count".

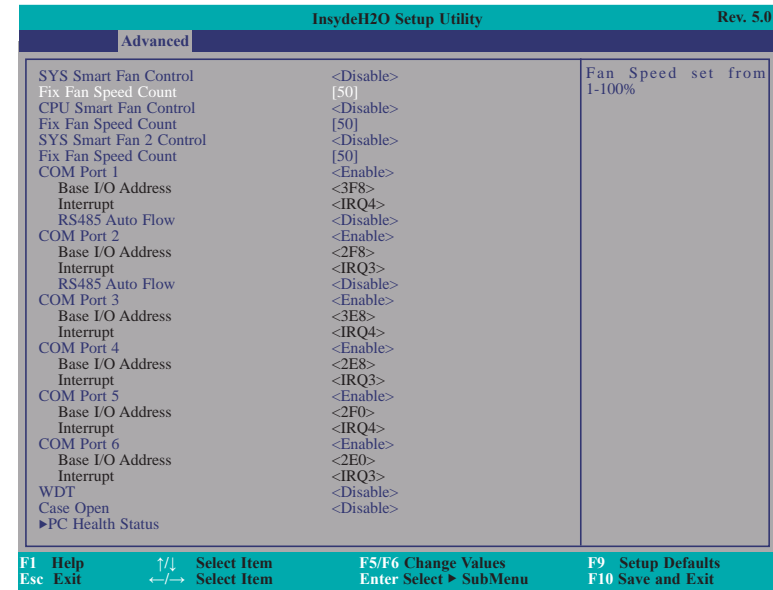
**SYS Smart Fan, CPU Smart Fan, SYS Smart Fan 2 Control**

Enable or disable the system/CPU smart fan/fan 2.

Boundary 1 to Boundary 4

Set the boundary temperatures that determine the operation of the fan with different fan speeds accordingly. For example, when the system or the CPU temperature reaches boundary temperature 1, the system or CPU fan should be turned on and operate at the designated speed. The range is from 0-127°C.

Fan Speed Count 1 to Fan Speed Count 4

Set the fan speed. The range is from 1-100% (full speed).

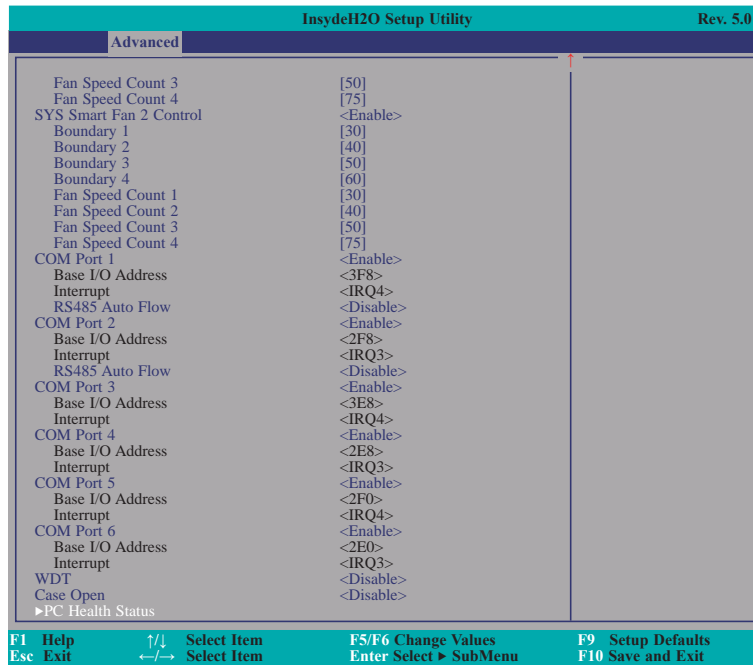

COM Port 1 to COM Port 6

Configure the settings to use the serial port.

Disable No configuration

Enable User configuration

RS485 Auto Flow

Enable or disable RS485 auto flow.

WDT

Enable or disable the watchdog function. A counter will appear if you select to enable

WDT. Input any value between 1 to 255 seconds.

Case Open

Enable or disable the case open detection function.

PC Health Status

This section displays the PC health status.

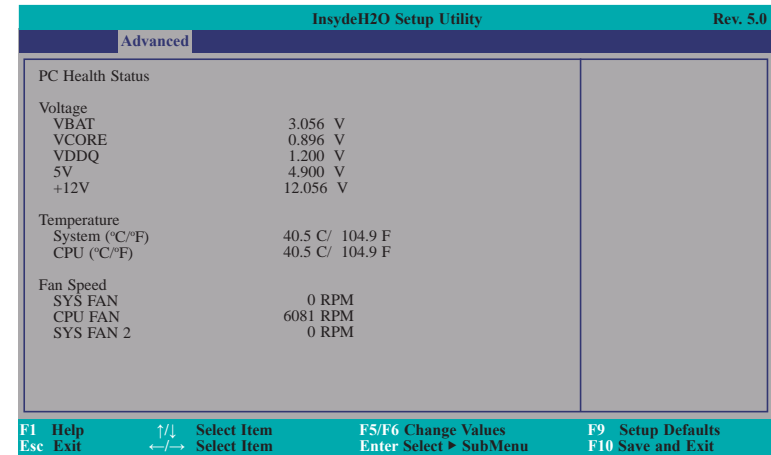

Console Redirection

This section configures settings relevant to console redirection.

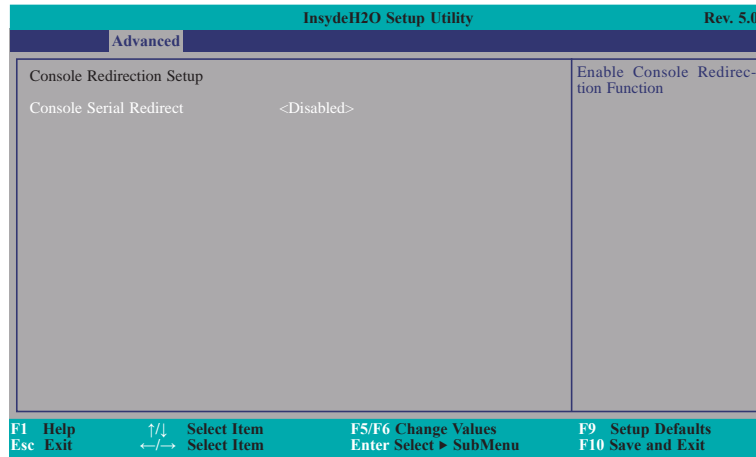

Console Serial Redirect

This field is used to enable or disable the console serial redirection function.

When Console Serial Redirect is set to enabled, the screen will appear like below:

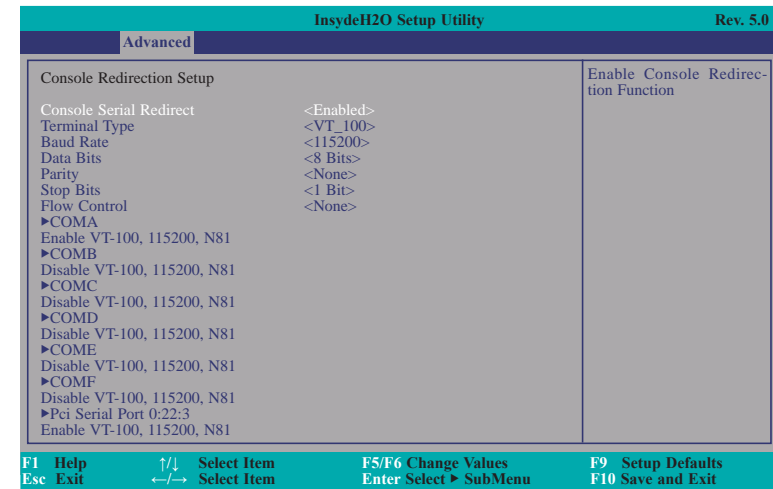

Terminal Type

Select terminal type: VT_100, VT_100+, VT_UTF8 or PC_ANSI.

Baud Rate

Select baud rate: 115200, 57600, 38400, 19200, 9600, 4800, 2400 or 1200.

Data Bits

Select data bits: 7 bits or 8 bits.

Parity

Select parity bits: none, even or odd.

Stop Bits

Select stop bits: 1 bit or 2 bits.

Flow Control

Select flow control type: none, RTS/CTS or XON/XOFF.

COMA to COMF and Pci Serial Port 0:22:3

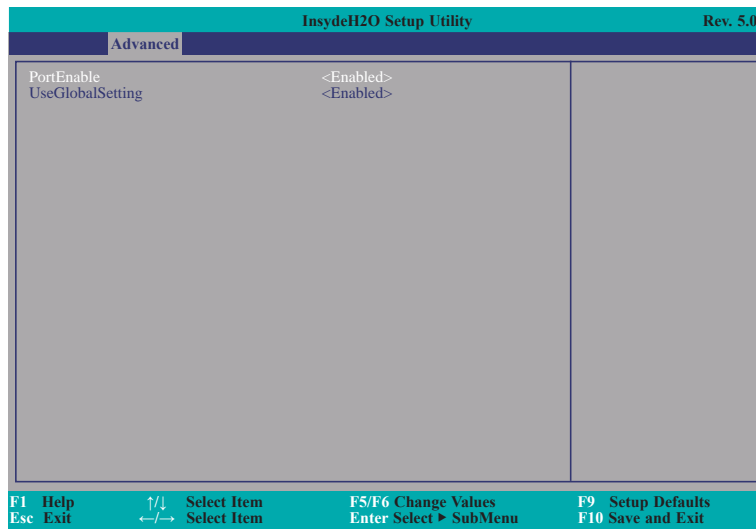

When UseGlobalSetting is set to disabled, the screen will appear like shown below:

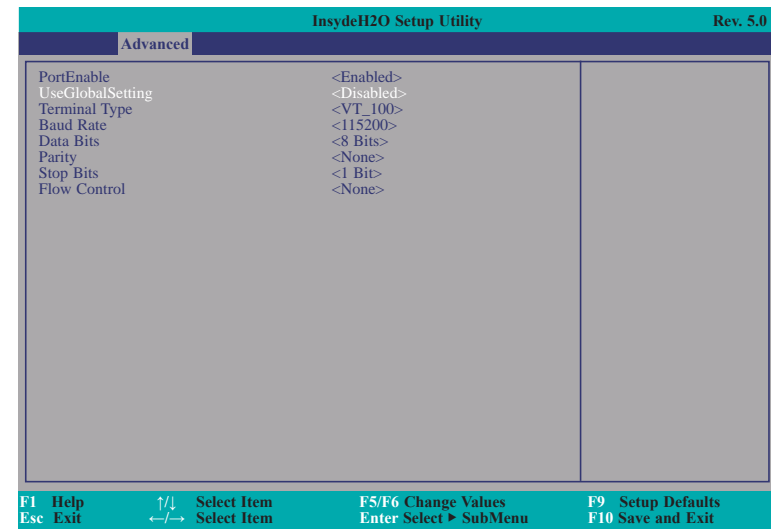

PortEnable

This field is used to enable or disable the COM port to redirect the console.

UseGlobalSetting

This field is to enable or disable to use global setting. When enabled the global setting, setting of the COM port will be the same as those in Console Redirection section. When disabled the global setting, setting of the COM port can be configured independently in this section.

Security

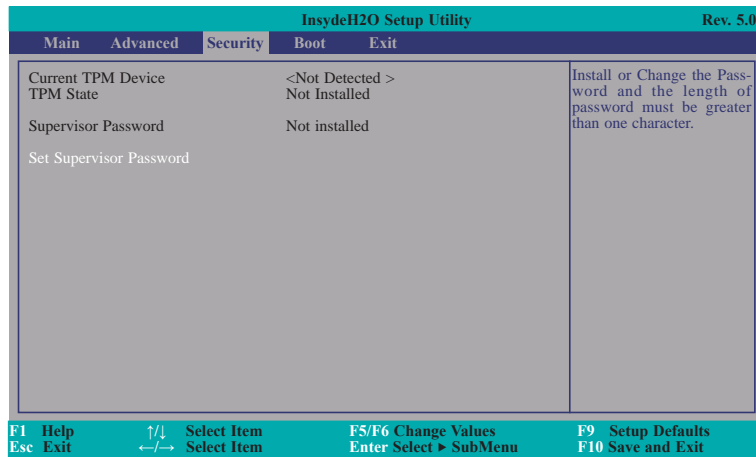

Set Supervisor Password

Set the supervisor's password and the length of the password must be greater than one character.

Boot

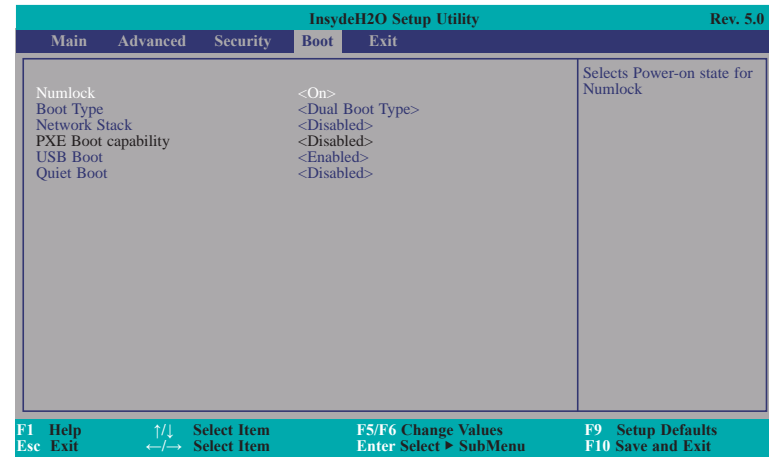

Numlock

Select the power-on state for numlock.

Boot Type

Select the boot type. The options are Dual Boot Type, Legacy Boot Type or UEFI Boot Type.

If you select "Dual Boot Type" or "UEFI Boot Type", the "Network Stack", "PXE Boot capability", "USB Boot" and "Quiet Boot" will show up.

If you select "Legacy Boot Type", "PXE Boot to LAN", "USB Boot" and "Quiet Boot" will show up.



Note:

If the boot type is set to UEFI, the method for RAID volume creation will be different. Please refer to Chapter 5 - RAID for more information.

Network Stack

This field is used to enable or disable network stack.

PXE Boot capability

Disabled Support Network Stack

UEFI IPv4/IPv6

Legacy Legacy PXE OPROM only

PXE Boot to LAN

Disable or enable PXE boot to LAN.

USB Boot

Enable or disable to change USB boot devices boot order.

Quiet Boot

Enable or disable booting in text mode.

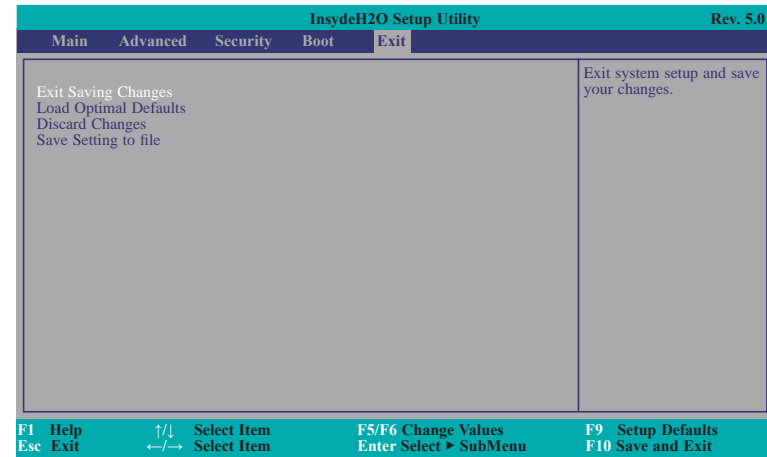
Exit**Exit Saving Changes**

Select Yes and then press <Enter> to exit the system setup and save your changes.

Load Optimal Defaults

Select YES and then press <Enter> to load optimal defaults.

Discard Changes

Select YES and then press <Enter> to exit the system setup without saving your changes.

Save Setting to file

Select this option to save BIOS configuration settings to a USB flash device.

Restore Setting from file

This field will appear only when a USB flash device is detected. Select this field to restore setting from the USB flash device.

Updating the BIOS

To update the BIOS, you will need the new BIOS file and a flash utility. Please contact technical support or your sales representative for the files.

Notice: BIOS SPI ROM

1. The Intel® Management Engine has already been integrated into this system board. Due to the safety concerns, the BIOS (SPI ROM) chip cannot be removed from this system board and used on another system board of the same model.
2. The BIOS (SPI ROM) on this system board must be the original equipment from the factory and cannot be used to replace one which has been utilized on other system boards.
3. If you do not follow the methods above, the Intel® Management Engine will not be updated and will cease to be effective.

**Note:**

- a. You can take advantage of flash tools to update the default configuration of the BIOS (SPI ROM) to the latest version anytime.
- b. When the BIOS IC needs to be replaced, you have to populate it properly onto the system board after the EEPROM programmer has been burned and follow the technical person's instructions to confirm that the MAC address should be burned or not.

Chapter 4 - Supported Software

Please download drivers, utilities and software applications required to enhance the performance of the system board at <https://www.dfi.com/DownloadCenter>.

Intel Chipset Software Installation Utility

The Intel Chipset Software Installation Utility is used for updating Windows® INF files so that the Intel chipset can be recognized and configured properly in the system.

To install the utility, download “KD331-C236/Q170 Chipset Driver” zip file at our website.

1. Setup is ready to install the utility. Click “Next”.



2. Read the license agreement then click “Accept”.

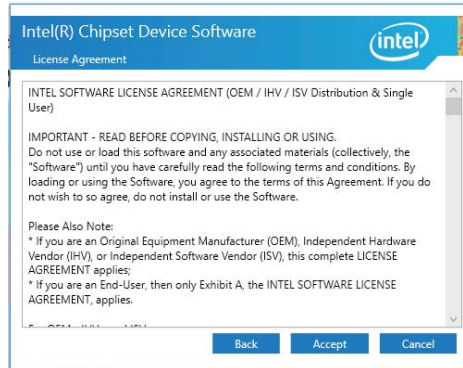

3. Go through the readme document for more installation tips then click “Install”.

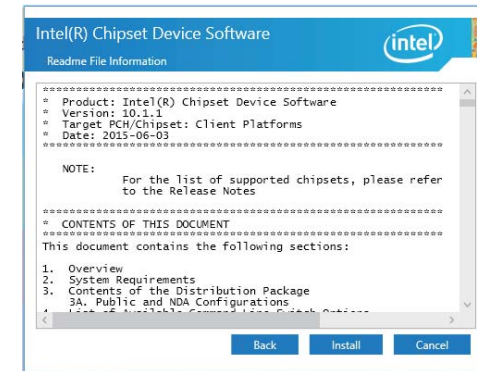

4. The step displays the installing status in the progress.



5. After completing installation, click “Restart Now” to exit setup.

Restarting the system will allow the new software installation to take effect.



Intel Graphics Drivers

To install the driver, download “KD331-C236/Q170 Graphics Driver” zip file at our website.

1. Setup is now ready to install the graphics driver. Click “Next”.

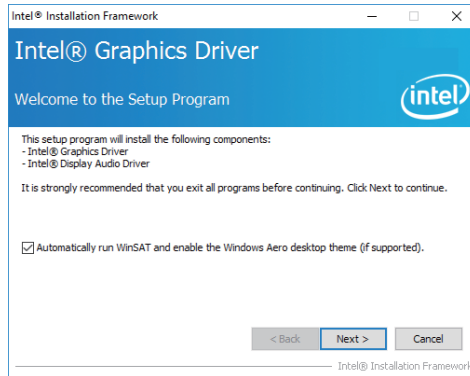

By default, the “Automatically run WinSAT and enable the Windows Aero desktop theme” is enabled. With this enabled, after installing the graphics driver and the system rebooted, the screen will turn blank for 1 to 2 minutes (while WinSAT is running) before the Windows 7/8.1/10 desktop appears. The “blank screen” period is the time Windows is testing the graphics performance.

We recommend that you skip this process by disabling this function then click “Next”.

2. Read the license agreement then click “Yes”.

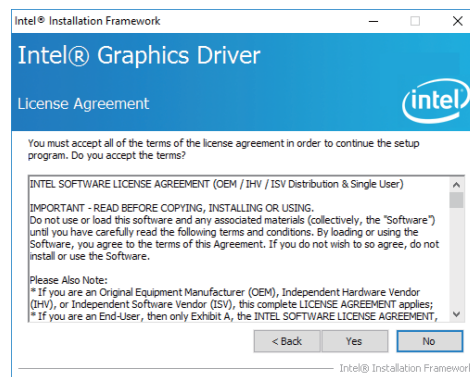

3. Go through the readme document for system requirements and installation tips then click “Next”.

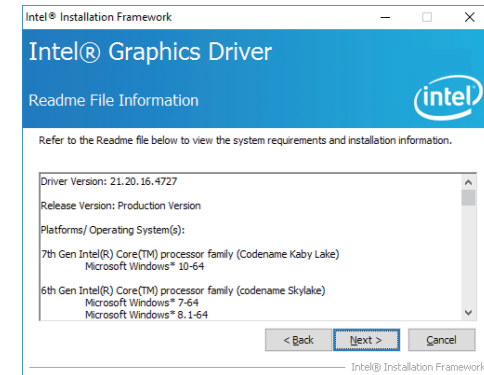

4. Setup is now installing the driver. Click “Next” to continue.

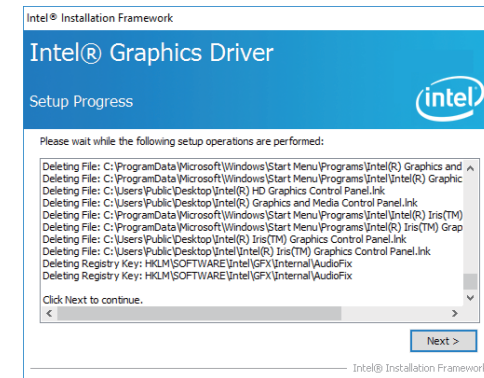

5. Click “Yes, I want to restart this computer now” then click “Finish”.

Restarting the system will allow the new software installation to take effect.

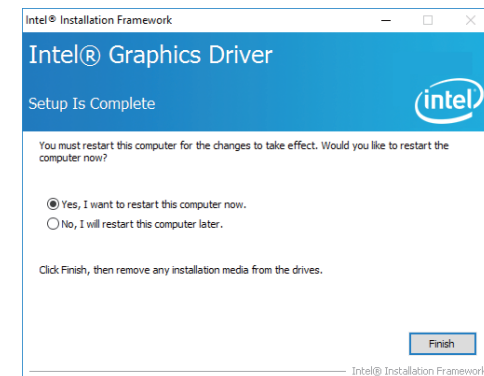

Audio Drivers

To install the driver, download “KD331-C236/Q170 Audio Driver” zip file at our website.

1. Setup is ready to install the driver. Click “Next”.

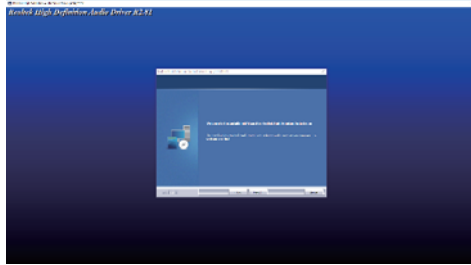

2. Click “Yes, I want to restart my computer now” then click “Finish”.

Restarting the system will allow the new software installation to take effect.

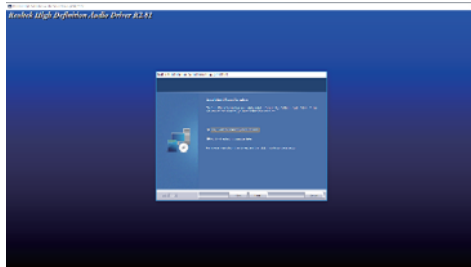

Intel LAN Drivers

To install the driver, download “KD331-C236/Q170 LAN Driver” zip file at our website.

1. Setup is ready to install the driver. Click “Next”.

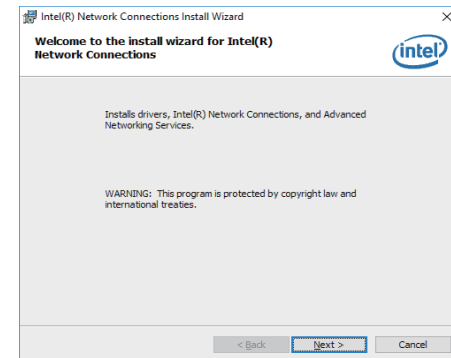

2. Click “I accept the terms in the license agreement” then click “Next”.

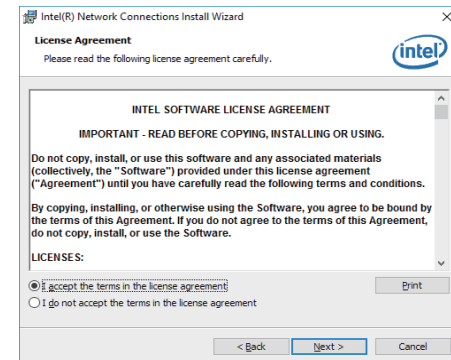

3. Select the program features you want installed then click “Next”.

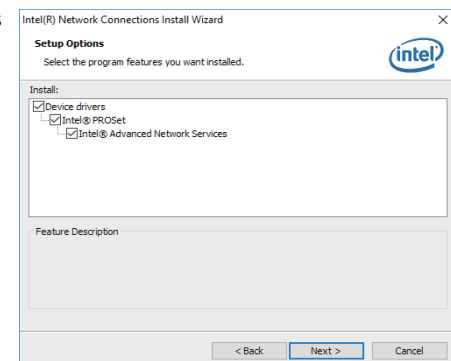

4. Click "Install" to begin the installation.

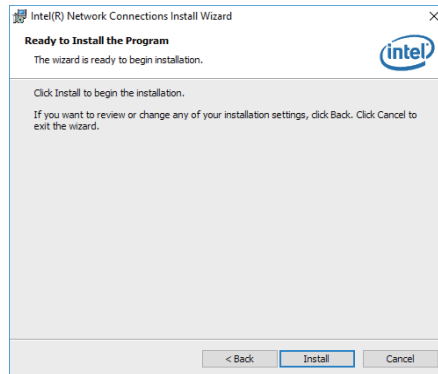

5. The step displays the installing status in the progress.

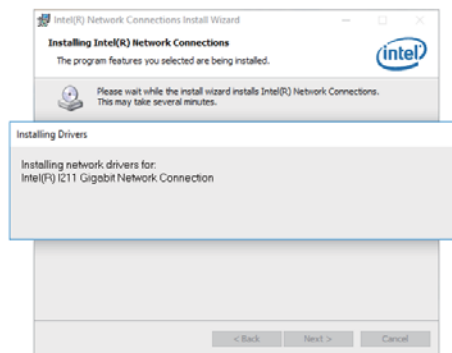

6. After completing installation, click "Finish".

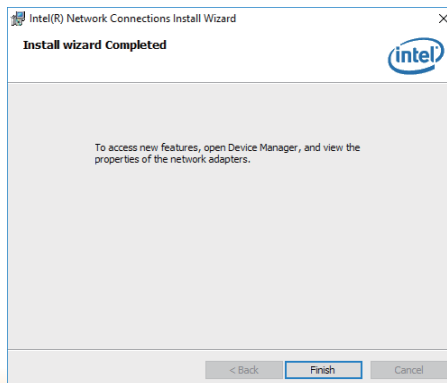

Kernel Mode Driver Framework (For Windows 7 only)

To install the driver, download "KD331-C236/Q170 KMDF" zip file at our website.

1. Click "Yes" to install the update.



2. The update is installed now.

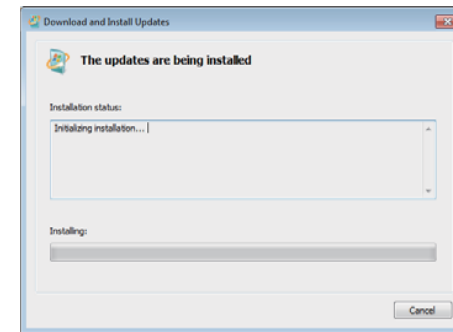

3. Click "Restart Now" to restart your computer when the installation is complete.

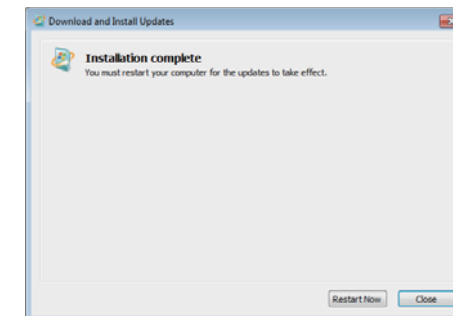

Intel Management Engine Interface Drivers

To install the driver, download “KD331-C236/Q170 MEI Driver” zip file at our website.

1. Setup is ready to install the driver. Click “Next”.

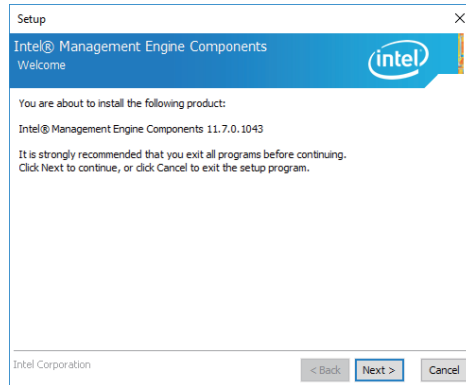

2. Read the license agreement then tick “I accept the terms in the License Agreement”. Click “Next”.

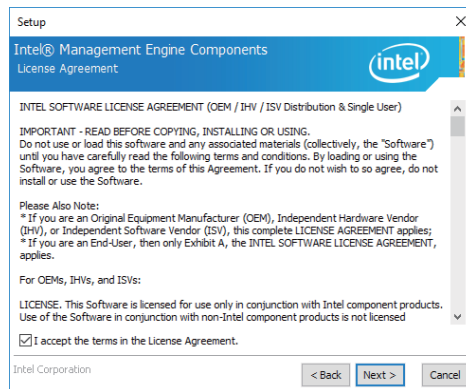

3. Click “Next” to install to the default folder, or click “Change” to choose another destination folder.

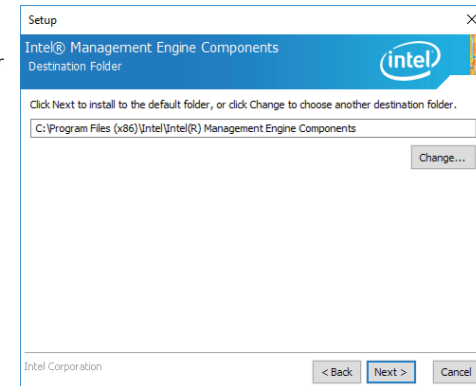

4. Please wait while the product is being installed.

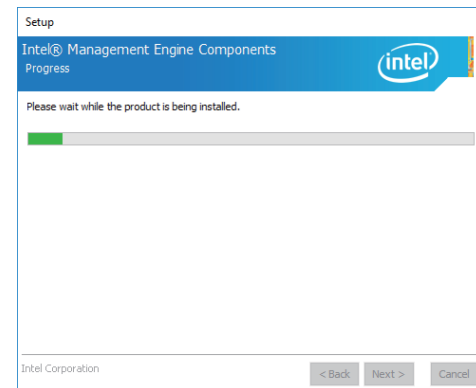

5. After completing installation, click “Finish”.

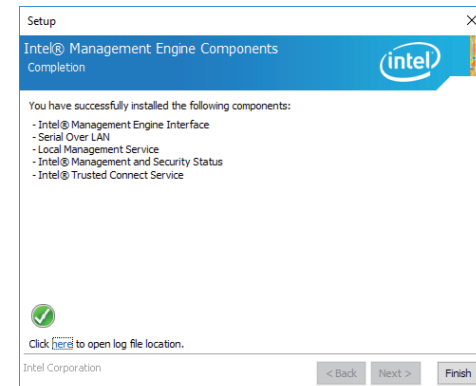

Intel USB 3.0 Drivers (For Windows 7 and Windows 8.1)

To install the driver, download “KD331-C236/Q170 USB3.0 Driver” zip file at our website.

1. Setup is ready to install the driver. Click “Next”.

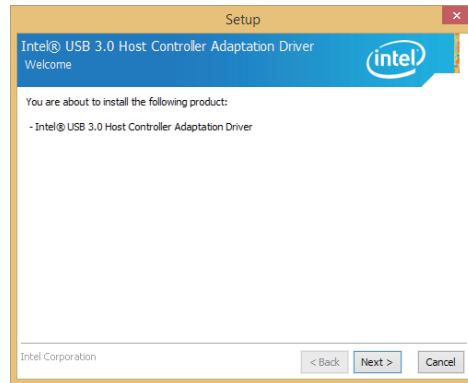

2. Read the license agreement then tick “I accept the terms in the license agreement”. Click “Next”.

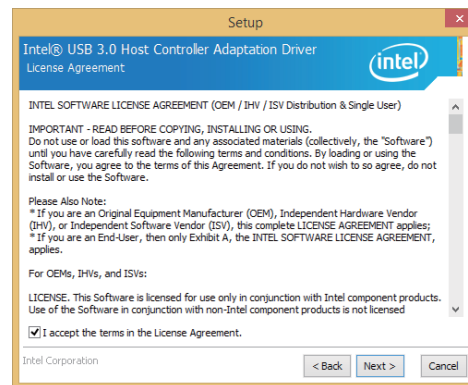

3. Click “Next”.

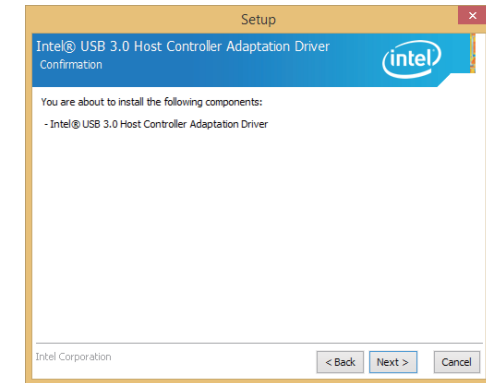

4. Setup is currently installing the driver. After installation has completed, click “Next”.

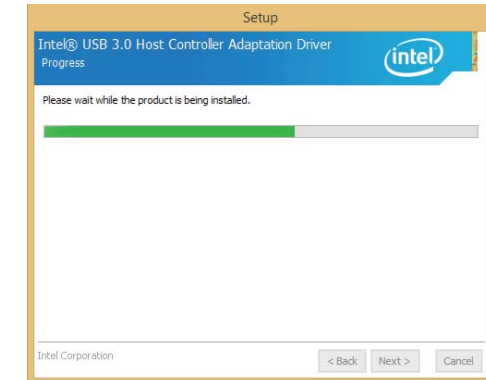

5. Click “Yes, I want to restart this computer now” then click “Finish”.

Restarting the system will allow the new software installation to take effect.

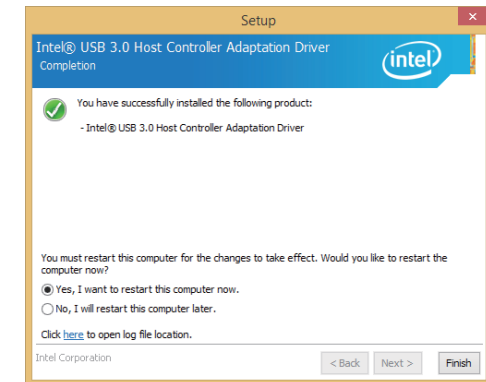

Intel Rapid Storage Technology

The Intel Rapid Storage Technology is a utility that allows you to monitor the current status of the SATA drives. It enables enhanced performance and power management for the storage subsystem.

To install the driver, download “KD331-C236/Q170 IRST Driver” zip file at our website. Please refer to **Chapter 5** for more information.

SIO Driver

To install the driver, download “KD331-C236/Q170 SIO Driver” zip file at our website.

1. Setup is ready to install the driver.
Click “Next”.

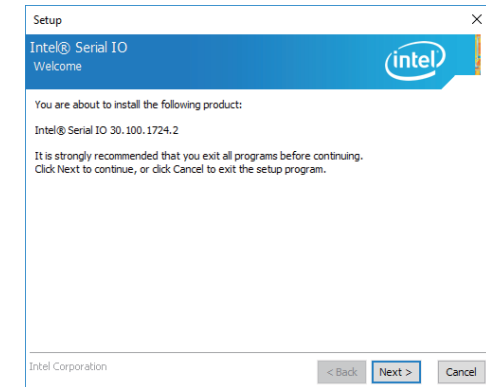

2. Read the license agreement carefully.
Tick “I accept the terms in the License Agreement” then click “Next”.



3. Go through the readme document for system requirements and installation tips then click "Next".

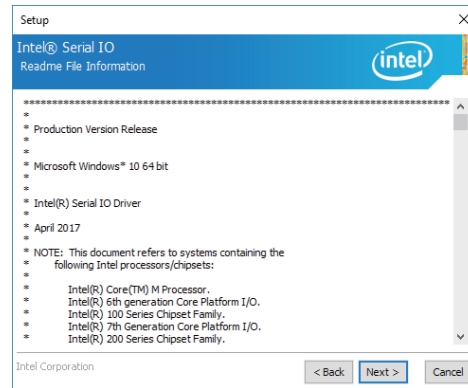

4. Setup is ready to install the driver. Click "Next".

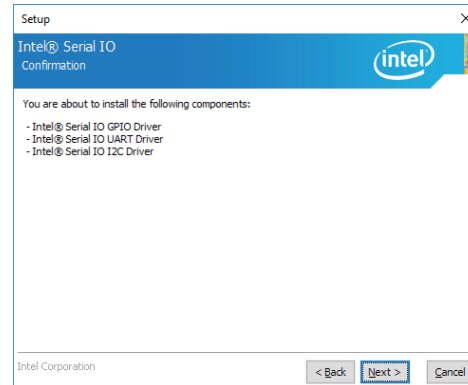

5. Setup is now installing the driver.

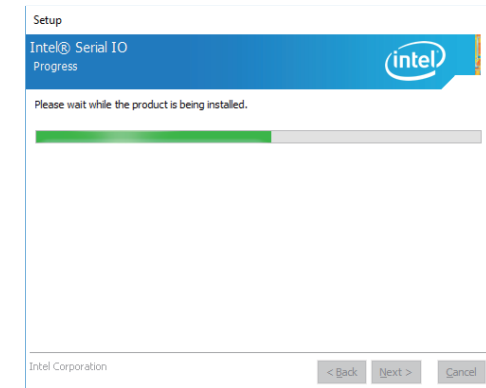

6. Click "Yes, I want to restart this computer now" then click "Finish".

Restarting the system will allow the new software installation to take effect.

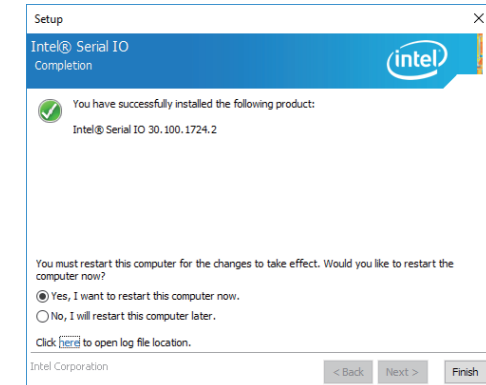

Microsoft Framework 4.5 (For Windows 7)

Note:

Before installing Microsoft Framework 4.5, make sure you have updated your Windows 7 operating system to Service Pack 3.

To install the driver, download “KD331-C236/Q170 DotNetFx45” zip file at our website.

1. Setup is now extracting files.

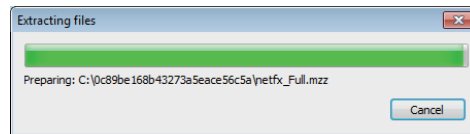

2. Read the license agreement carefully.

Click “I have read and accept the terms of the License Agreement” then click “Install”.

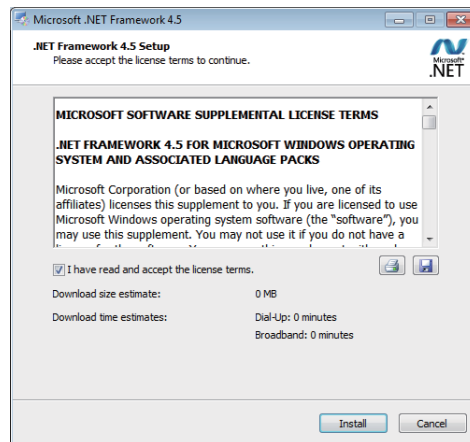

3. Setup is now installing the driver.

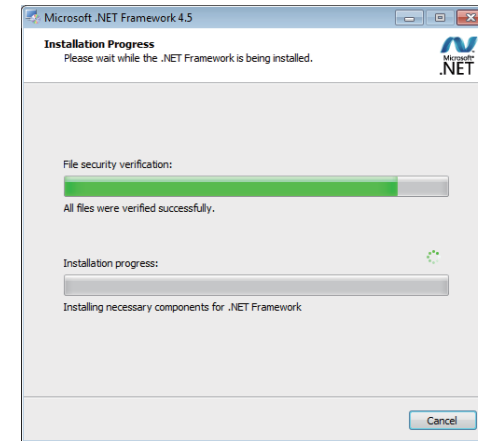

4. Click “Finish”.

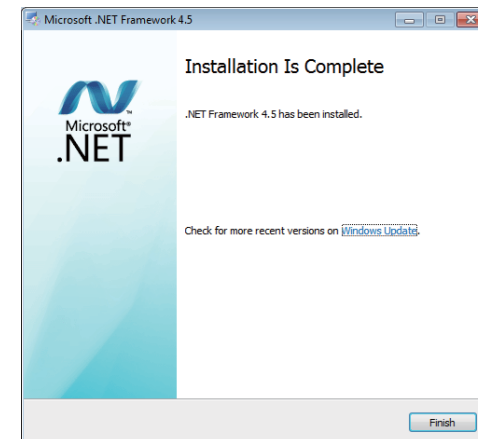

Infinion TPM 1.2 Driver and Tool (Optional)

To install the driver, download “KD331-C236/Q170 TPM1.2 Utility” zip file at our website.

1. The setup program is preparing to install the driver.



2. The setup program is now ready to install the utility. Click “Next”.



3. Click “I accept the terms in the license agreement” and then click “Next”.

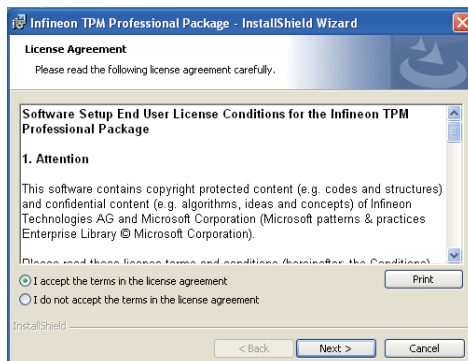

4. Enter the necessary information and then click “Next”.

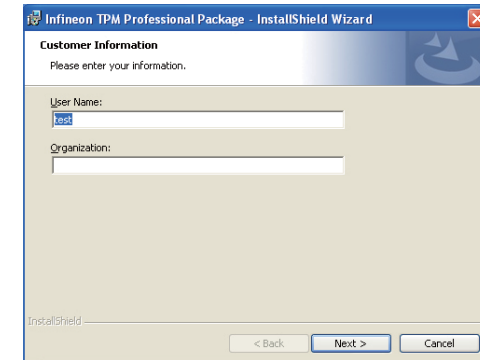

5. Select a setup type and then click “Next”.

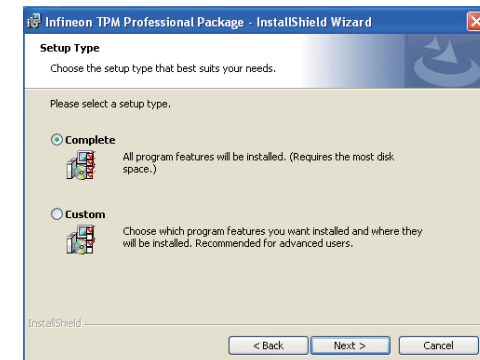

6. Click “Install”.

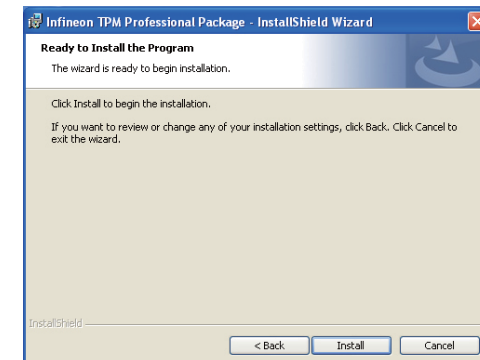

7. TPM requires installing the Microsoft Visual C++ package prior to installing the utility. Click "Install".

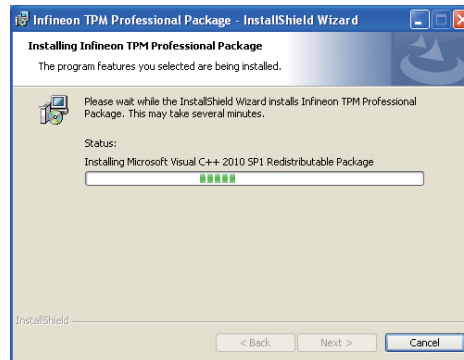

8. The setup program is currently installing the Microsoft Visual C++ package.

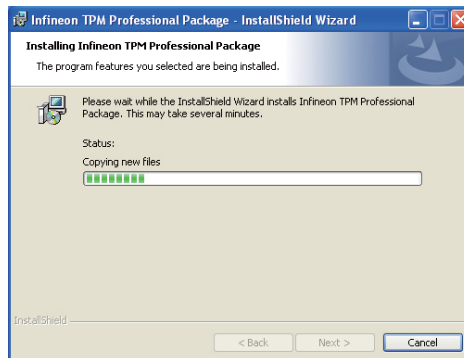

9. Click "Finish".



10. Click "Yes" to restart your system.

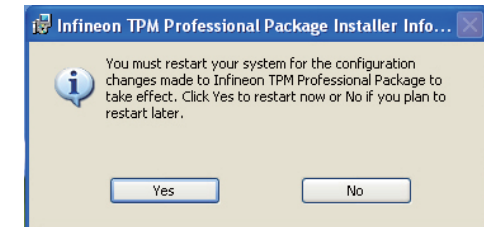

Infineon TPM 2.0 Driver and Tool (Optional)

To install the driver, download “KD331-C236/Q170 TPM2.0 Hotfix” zip file at our website.

1. Click “OK”.

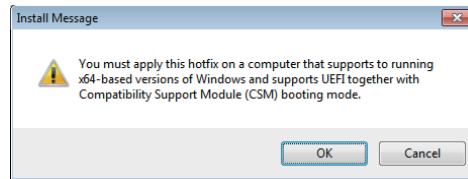

2. Click “Yes”.

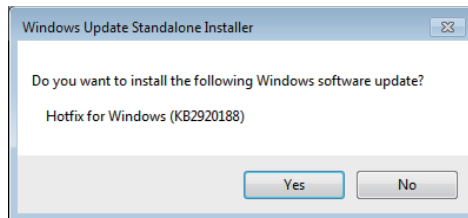

3. Setup is now installing the updates.

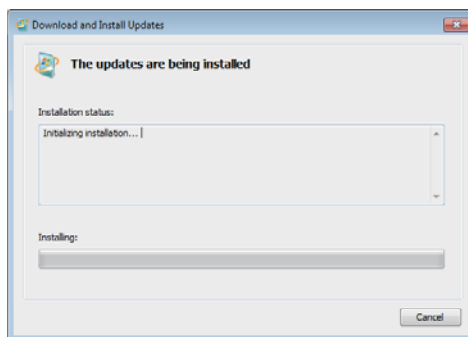

4. Click “Restart now” to restart your system.

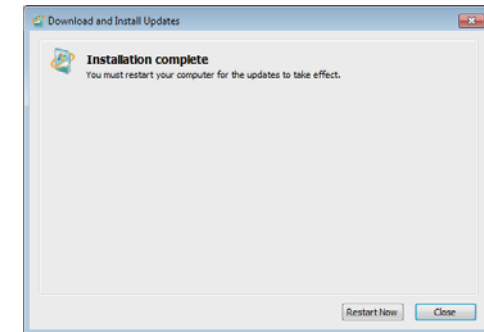

Adobe Acrobat Reader 9.3

To install the reader, download “KD331-C236/Q170 Driver Package” iso file at our website.

1. Click “Next” to install or click “Change Destination Folder” to select another folder.

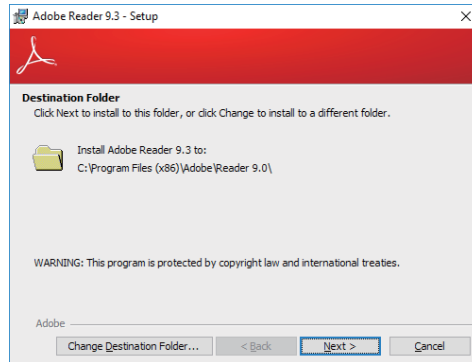

2. Click “Install” to begin installation.

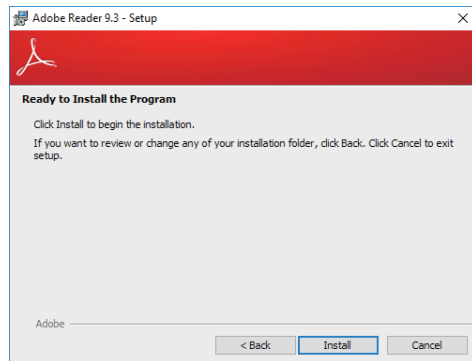

3. Setup is now installing the driver.

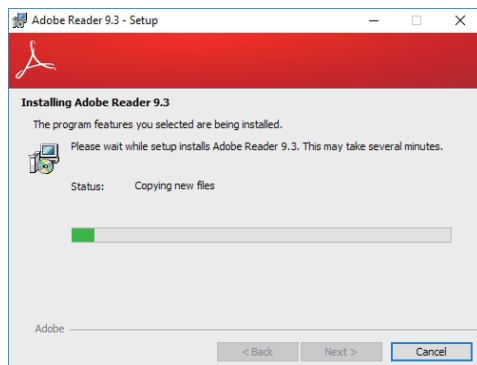

4. Click “Finish” to exit installation.

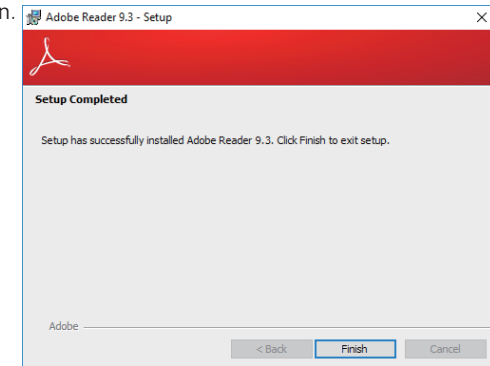

Chapter 5 - RAID

The system board allows configuring RAID on Serial ATA drives. It supports RAID 0, RAID 1, RAID 5 and RAID 10.

RAID Levels

RAID 0 (Striped Disk Array without Fault Tolerance)

RAID 0 uses two new identical hard disk drives to read and write data in parallel, interleaved stacks. Data is divided into stripes and each stripe is written alternately between two disk drives. This improves the I/O performance of the drives at different channel; however it is not fault tolerant. A failed disk will result in data loss in the disk array.

RAID 1 (Mirroring Disk Array with Fault Tolerance)

RAID 1 copies and maintains an identical image of the data from one drive to the other drive. If a drive fails to function, the disk array management software directs all applications to the other drive since it contains a complete copy of the drive's data. This enhances data protection and increases fault tolerance to the entire system. Use two new drives or an existing drive and a new drive but the size of the new drive must be the same or larger than the existing drive.

RAID 5

RAID 5 stripes data and parity information across hard drives. It is fault tolerant and provides better hard drive performance and more storage capacity.

RAID 10 (Mirroring and Striping)

RAID 10 is a combination of data striping and data mirroring providing the benefits of both RAID 0 and RAID 1. Use four new drives or an existing drive and three new drives for this configuration.

RAID Level	Min. Drives	Protection	Description
RAID 0	2	None	Data striping without redundancy
RAID 1	2	Single Drive Failure	Disk mirroring
RAID 5	3	Single Drive Failure	Block-level data striping with distributed parity
RAID 10	4	1 Disk Per Mirrored Stripe (not same mirror)	Combination of RAID 0 (data striping) and RAID 1 (mirroring)

Settings

To enable the RAID function, the following settings are required.

1. Connect the Serial ATA drives.
2. Enable RAID in the Insyde BIOS.
3. Create a RAID volume.
- 3-1. Create a RAID volume if the boot type is UEFI.
4. Install the Intel Rapid Storage Technology Utility.

Step 1: Connect the Serial ATA Drives

Refer to chapter 2 for details on connecting the Serial ATA drives.



Important:

1. Make sure you have installed the Serial ATA drives and connected the data cables otherwise you won't be able to enter the RAID BIOS utility.
2. Treat the cables with extreme caution especially while creating RAID. A damaged cable will ruin the entire installation process and operating system. The system will not boot and you will lost all data in the hard drives. Please give special attention to this warning because there is no way of recovering back the data.

Step 2: Enable RAID in the Insyde BIOS

1. Power-on the system then press to enter the main menu of the Insyde BIOS.
2. Go to "Advanced" menu and select the "SATA Configuration" menu.
3. Change the "SATA Mode Selection" to "Intel RST Premium" mode for KD331-Q170 or "Intel RST Premium With Intel Optane System Acceleration" mode for KD331-C236.
4. Save the changes in the "Exit" menu.
5. Reboot the system.

Step 3: Create a RAID Volume

1. When the Intel® RST option ROM status screen displays during POST, press <Ctrl> and <I> simultaneously to enter the option ROM user interface.
2. Select 1: Create RAID Volume and press <Enter>.
3. Create a volume name and press <Enter>.
4. Use the up or down arrow keys to select the RAID level and press <Enter>.
5. Use the up or down arrow keys to select the strip size and press <Enter>.
6. Select the capacity and press <Enter>. You must select less than one hundred percent of the available volume space to leave space for the second volume.
7. Press <Enter> to create the volume.
8. At the prompt, press <Y> to confirm volume creation.
9. Select 4: Exit and press <Enter>.
10. Press <Y> to confirm exit.

Step 3-1: Create a RAID Volume if the boot type is UEFI

If the boot type is set to UEFI, RAID volume creation will be different. Please use the following steps to create RAID volumes. To set the boot type, enter the Insyde BIOS and go to "Boot" > "Boot Type".

1. Go to the "Advanced" menu of the Insyde BIOS and select "UEFI Device Manager".

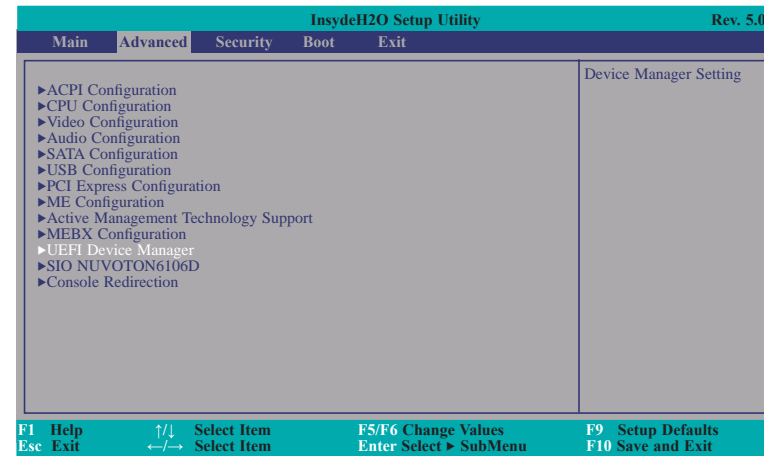

2. The screen displays all available drives. Select "Create RAID volume" to create a RAID volume".
3. Use the up or down arrow keys to select the RAID level and press <Enter>.
4. Use the up or down arrow keys to scroll through the list of hard drives and press <Enter> to select the drive.
5. Press <Enter>.
6. Use the up or down arrow keys to select the strip size and press <Enter>.
7. Enter the volume size and press <Enter>.
8. At the prompt, press <Y> to confirm volume creation.

Step 4: Install the Intel Rapid Storage Technology Utility

The Intel Rapid Storage Technology Utility can be installed from within Windows. It allows RAID volume management (create, delete, migrate) from within the operating system. It will also display useful SATA device and RAID volume information. The user interface, tray icon service and monitor service allow you to monitor the current status of the RAID volume and/or SATA drives. It enables enhanced performance and power management for the storage subsystem.

1. Download "KD331-C236/Q170 IRST Driver" zip file at our website.
2. Setup is ready to install the utility. Click "Next".

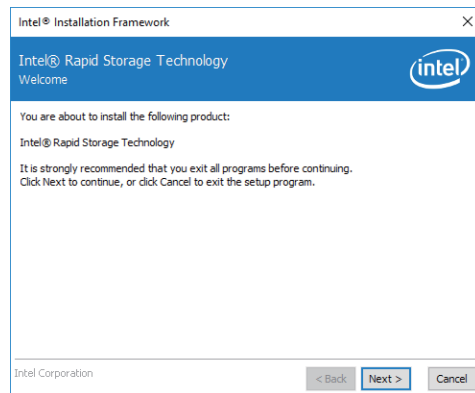

3. Read the license agreement and click "I accept the terms in the License Agreement". Then, click "Next".

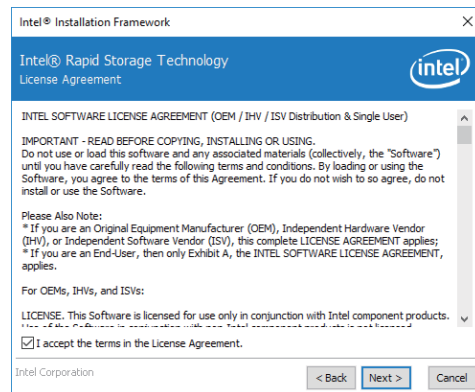

4. Go through the readme document to view system requirements and installation information then click "Next".

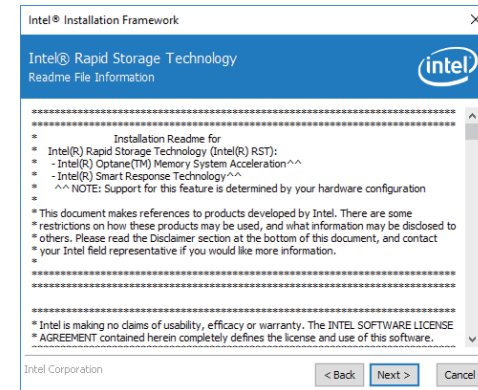

5. Click "Next" to install to the default folder or click "Change to choose another destination folder".

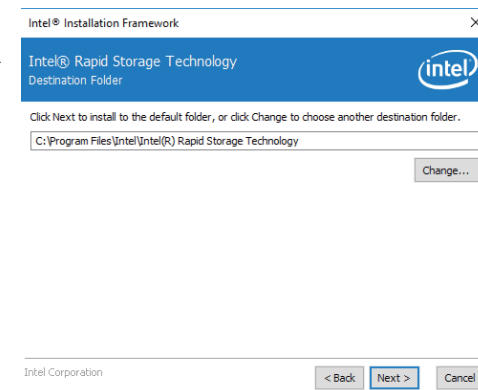

6. Confirm the installation and click "Next".

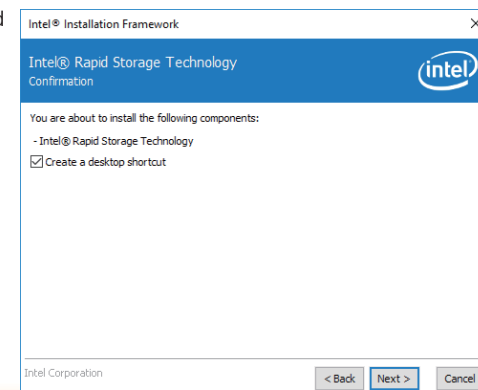

- Click “Yes, I want to restart this computer now” to complete the installation and then click “Finish”.

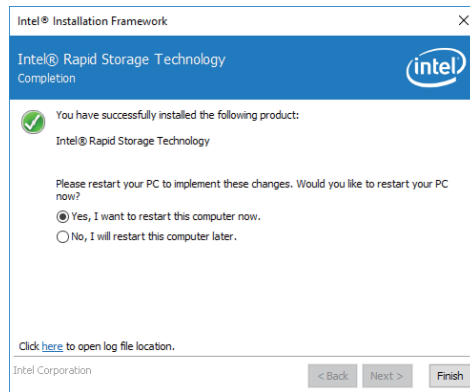

Chapter 6 - Intel AMT Settings

Overview

Intel Active Management Technology (Intel® AMT) combines hardware and software solution to provide maximum system defense and protection to networked systems.

The hardware and software information are stored in non-volatile memory. With its built-in manageability and latest security applications, Intel® AMT provides the following functions.

- **Discover**

Allows remote access and management of networked systems even while PCs are powered off; significantly reducing desk-side visits.

- **Repair**

Remotely repair systems after OS failures. Alerting and event logging help detect problems quickly to reduce downtime.

- **Protect**

Intel AMT's System Defense capability remotely updates all systems with the latest security software. It protects the network from threats at the source by proactively blocking incoming threats, reactively containing infected clients before they impact the network, and proactively alerting when critical software agents are removed.

Enable Intel® AMT in the Insyde BIOS

1. Power-on the system then press to enter the main menu of the Insyde BIOS.
2. In the **Advanced** menu, select **Active Management Technology Support**.

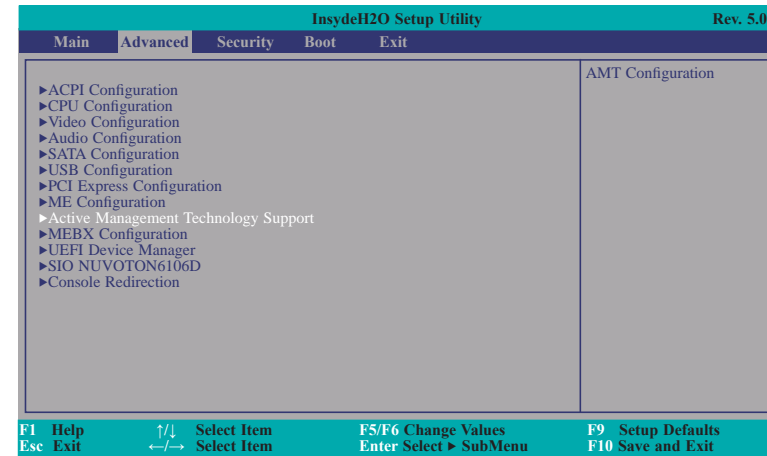

3. Select **Enabled** in the **Intel AMT Support** field.

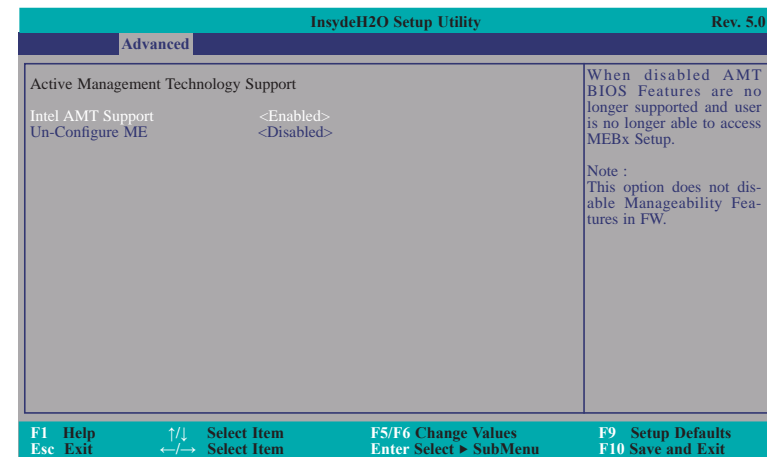

4. In the **Exit** menu, select **Exit Saving Changes** then select **Yes** and press Enter.

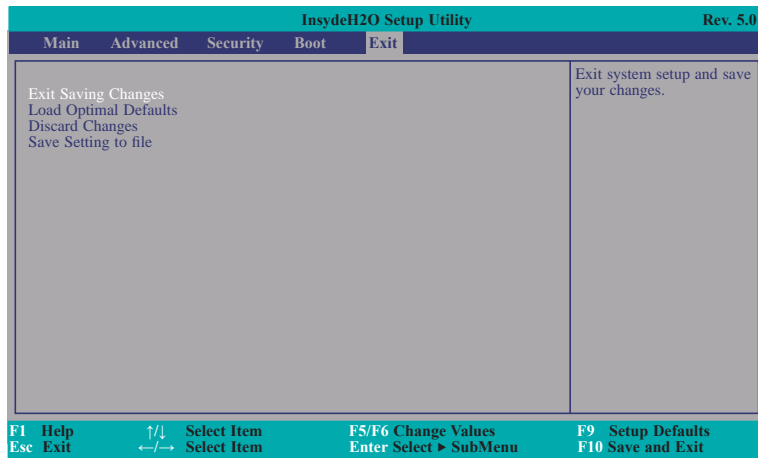

Enable Intel® AMT in the Intel® Management Engine BIOS Extension (MEBX) Screen

1. After the system reboots, press to enter the main menu of the Insyde BIOS.
2. In the **Advanced** menu, select **MEBX Configuration**.

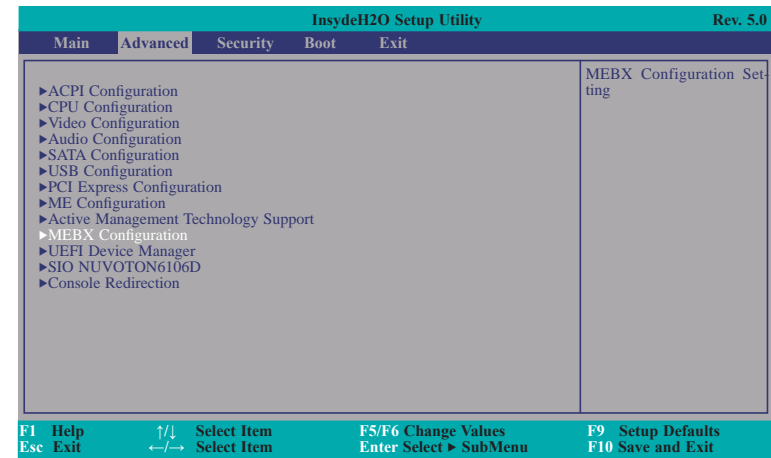

3. Select **MEBX Configuration** and press Enter.

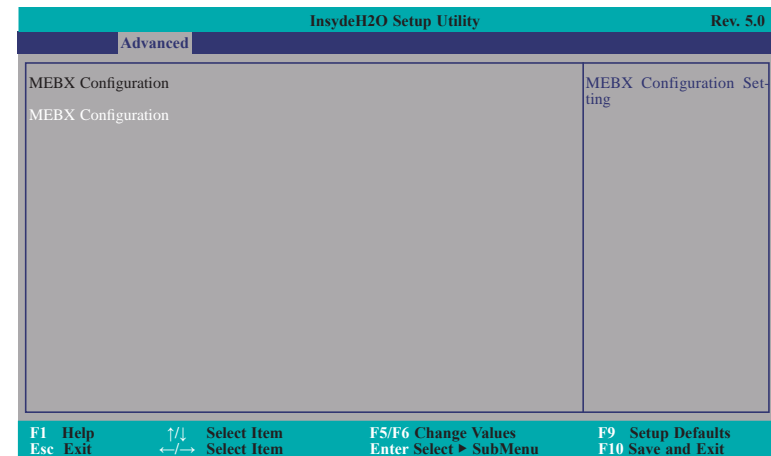

4. Select **MEBx Login** and press Enter. You will be prompted for a password. The default password is "admin". Enter the default password in the space provided under Intel(R) ME Password then press Enter.

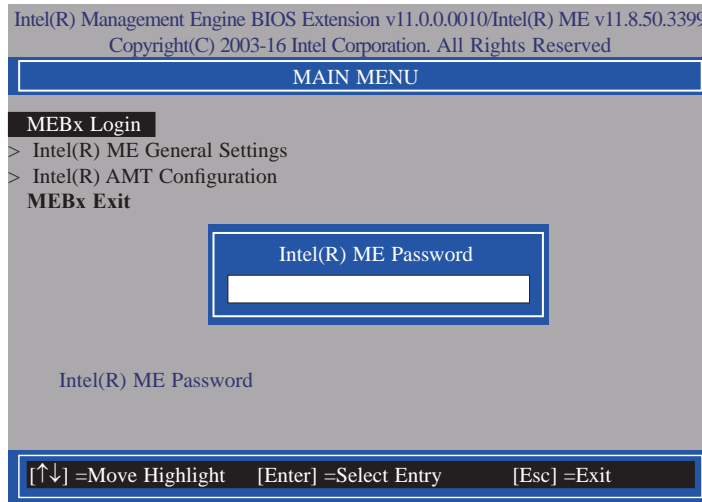

5. Enter a new password in the space provided under Intel(R) ME New Password then press Enter. The password must include:

- 8-32 characters
- Strong 7-bit ASCII characters excluding : , and " characters
- At least one digit character (0, 1, ...9)
- At least one 7-bit ASCII non alpha-numeric character, above 0x20, (e.g. !, \$, ;)
- Both lower case and upper case characters

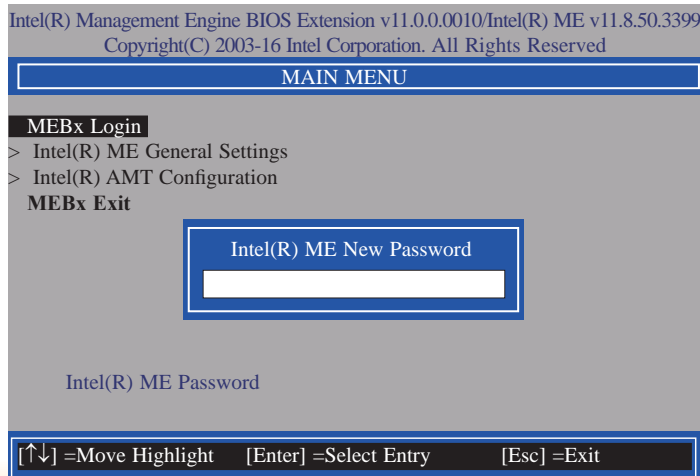

6. You will be asked to verify the new password. Enter the same new password in the space provided under Verify Password then press Enter.

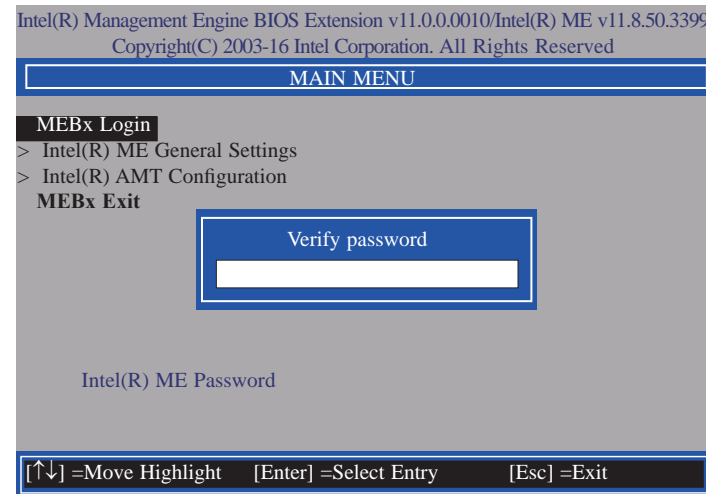

7. Select **Intel(R) ME General Settings** then press Enter.

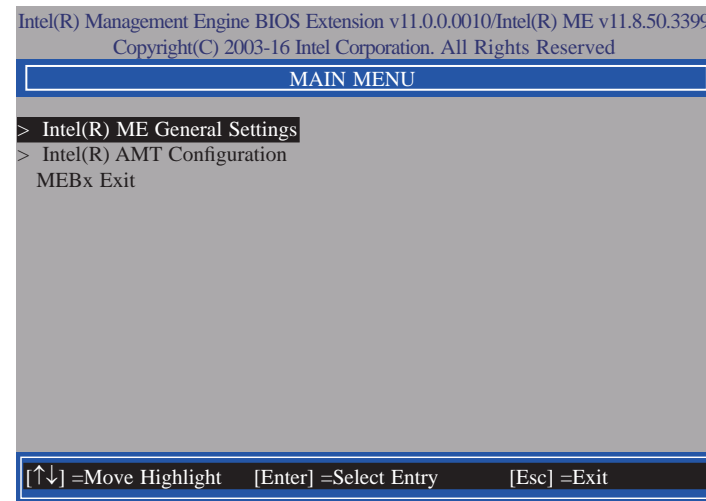

8. If you want to change ME password, select **Change ME Password** then press Enter. Enter the current password in the space provided under Intel(R) ME Password then press Enter.

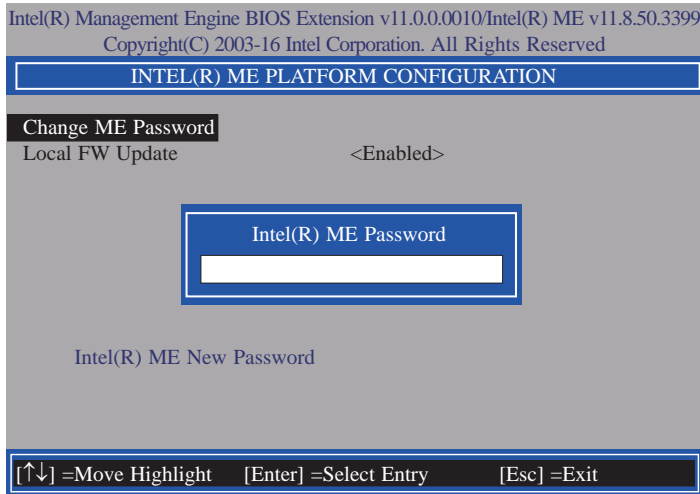

9. Enter a new password in the space provided under Intel(R) ME New Password then press Enter. The password must include:
- 8-32 characters
 - Strong 7-bit ASCII characters excluding : , and " characters
 - At least one digit character (0, 1, ...9)
 - At least one 7-bit ASCII non alpha-numeric character, above 0x20, (e.g. !, \$, ;)
 - Both lower case and upper case characters

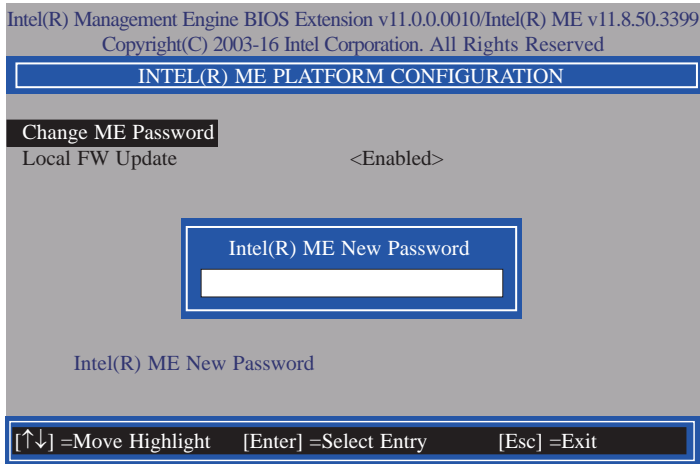

10. You will be asked to verify the new password. Enter the same new password in the space provided under Verify Password then press Enter.

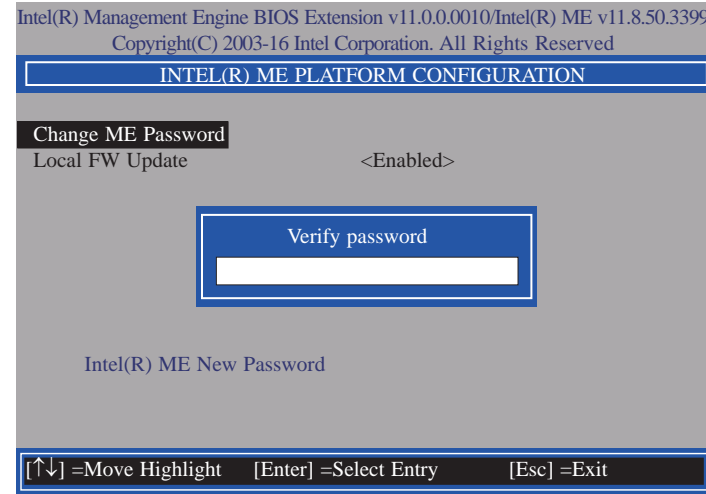

11. Select **Local FW Update** then press Enter. Select **Enabled** or **Disabled** or **Password Protected** then press Enter.

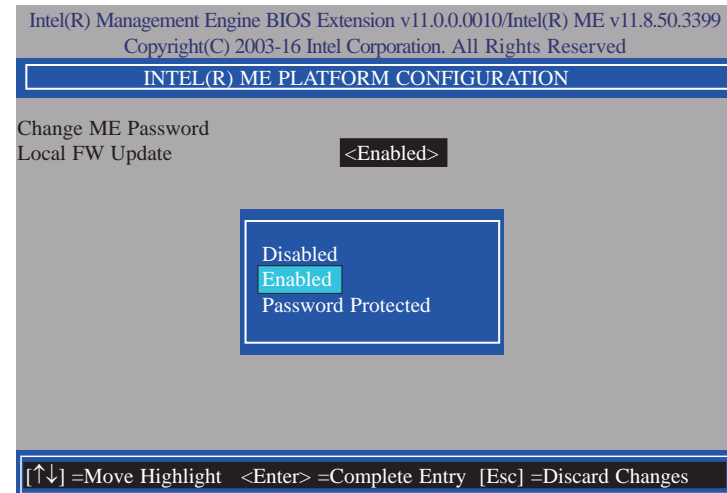

12. Press Esc until you return to the **Main Menu**. Select **Intel(R) AMT Configuration** then press Enter.

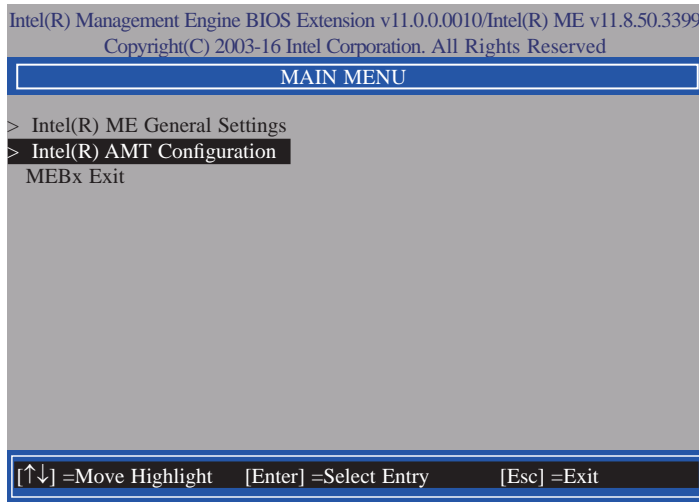

14. In the **Intel(R) AMT Configuration** menu, select **SOL/Storage Redirection/KVM** then press Enter.

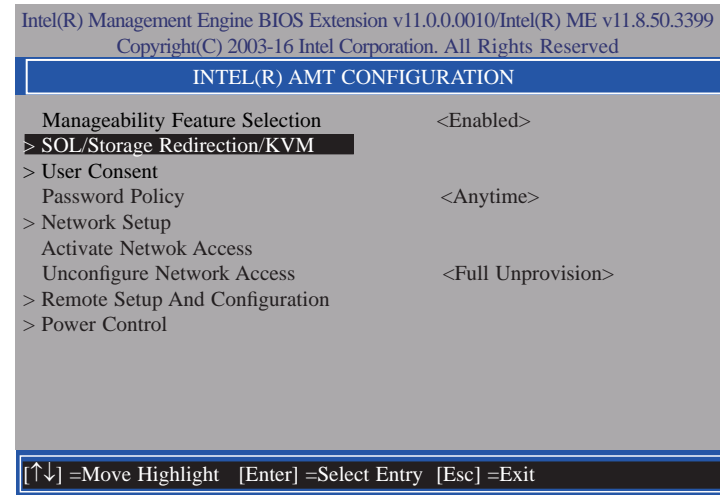

13. In the **Intel(R) AMT Configuration** menu, select **Manageability Feature Selection** then press Enter. Select **Enabled** or **Disabled** then press Enter.

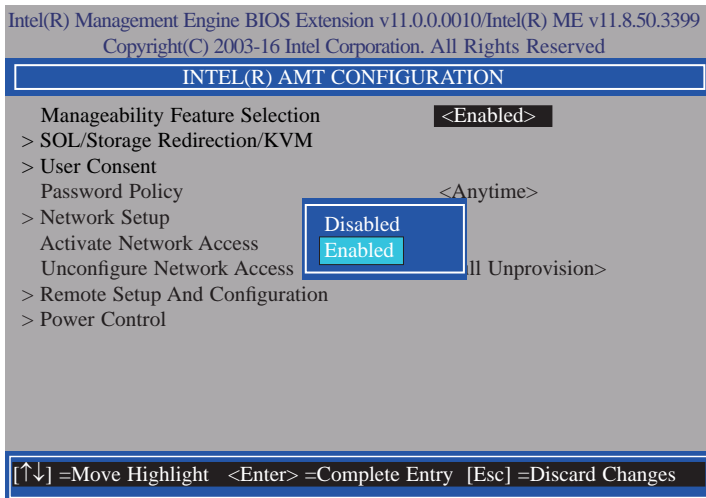

15. In the **SOL/Storage Redirection/KVM** menu, select **Username and Password** then press Enter. Select **Enabled** or **Disabled** then press Enter.

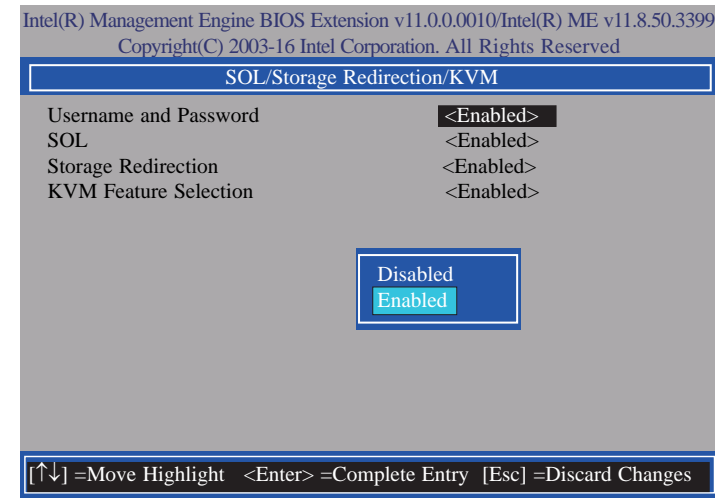

16. Select **SOL** then press Enter. Select **Enabled** or **Disabled** then press Enter.

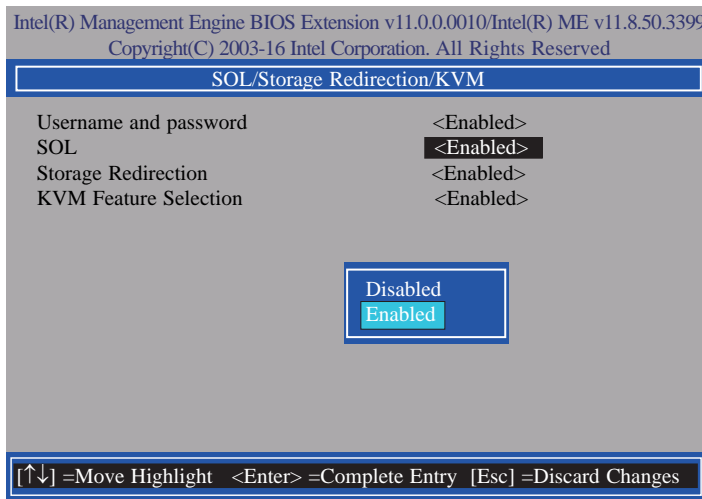

18. Select **KVM Feature Selection** then press Enter. Select **Enabled** or **Disabled** then press Enter.

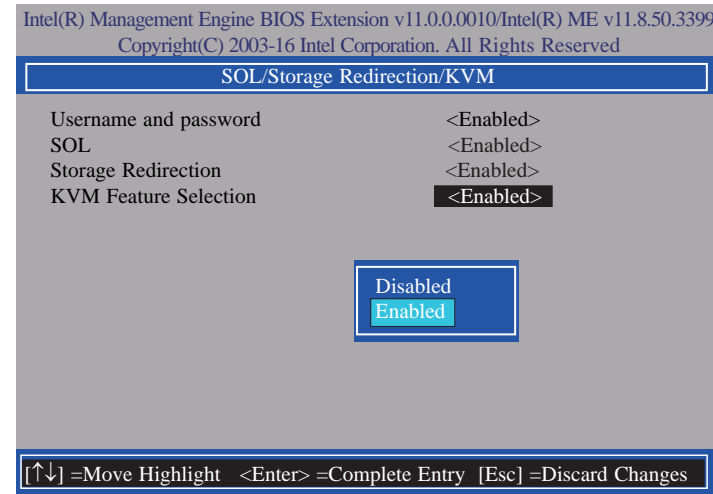

17. Select **Storage Redirection** then press Enter. Select **Enabled** or **Disabled** then press Enter.

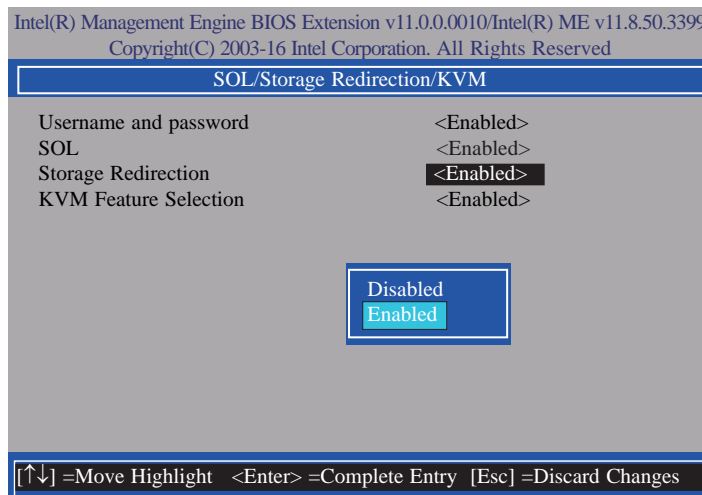

19. Press Esc until you return to the **Intel(R) AMT Configuration** menu. Select **User Consent** then press Enter.

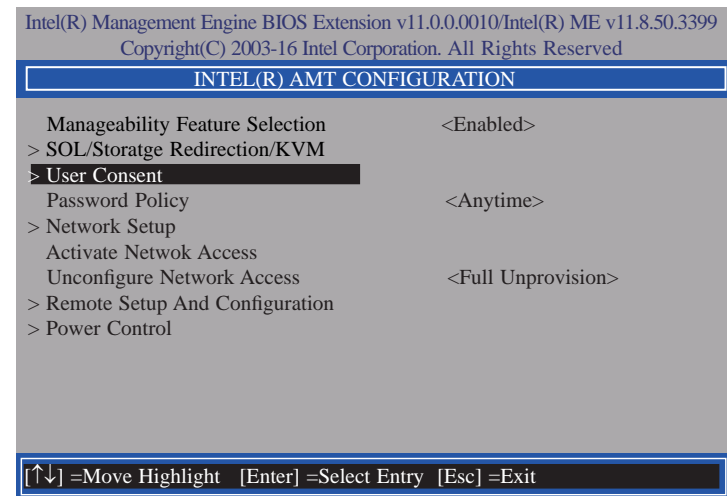

20. In the **User Consent** menu, select **User Opt-in** then press Enter. Select **NONE** or **KVM** or **ALL** then press Enter.

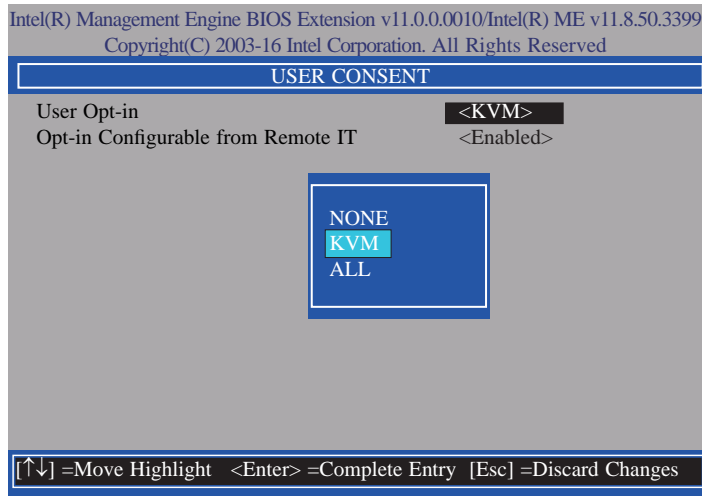

21. Select **Opt-in Configurable from Remote IT** then press Enter. Select **Enabled** or **Disabled** then press Enter.

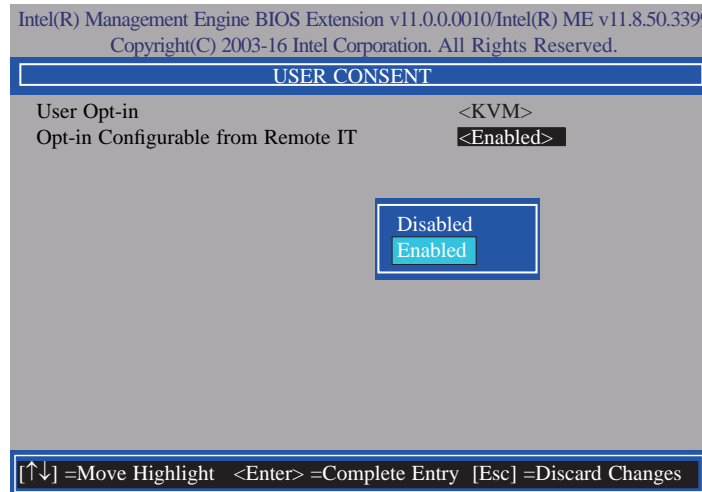

22. Press Esc until you return to the **Intel(R) AMT Configuration** menu. Select **Password Policy** then press Enter.

You may choose to use a password only during setup and configuration or to use a password anytime the system is being accessed.

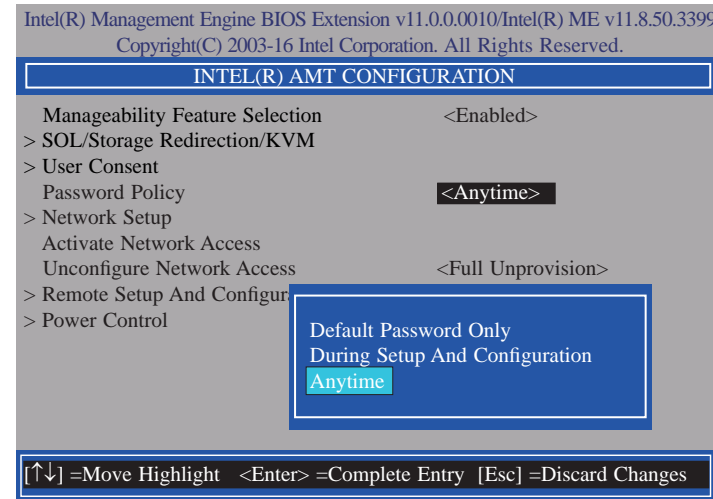

23. In the **Intel(R) AMT Configuration** menu, select **Network Setup** then press Enter.

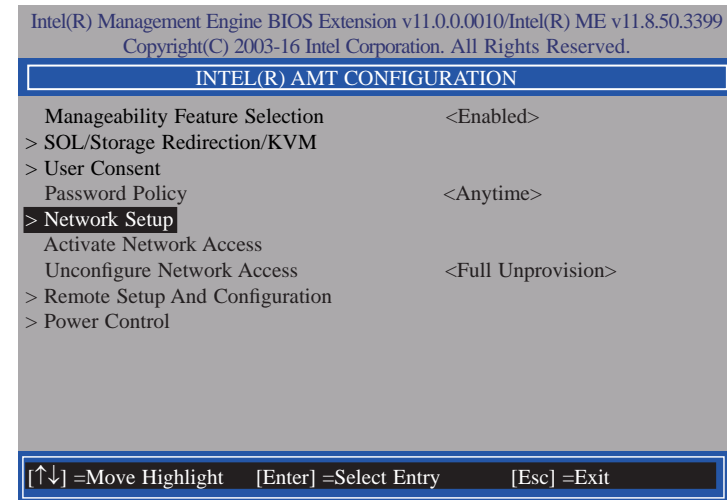

24. In the **Intel(R) ME Network Setup** menu, select **Intel(R) ME Network Name Settings** then press Enter.

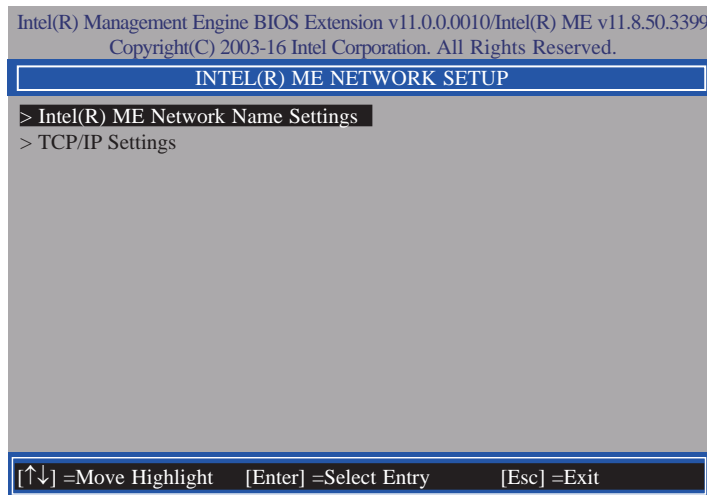

26. Select **Domain Name** then press Enter. Enter the computer's domain name then press Enter.

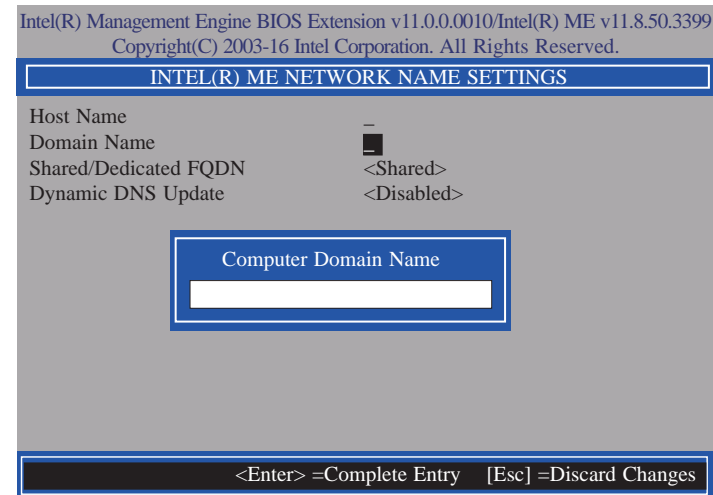

25. In the **Intel(R) ME Network Name Settings** menu, select **Host Name** then press Enter. Enter the computer's host name then press Enter.

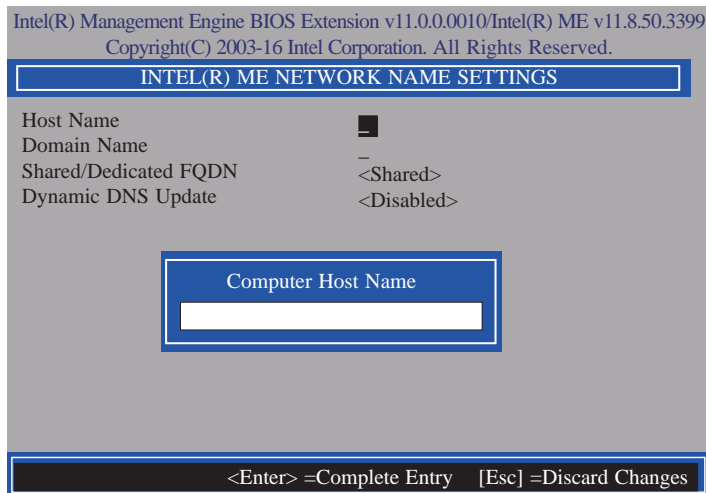

27. Select **Shared/Dedicated FQDN** then press Enter. Select **Shared** or **Dedicated** then press Enter.

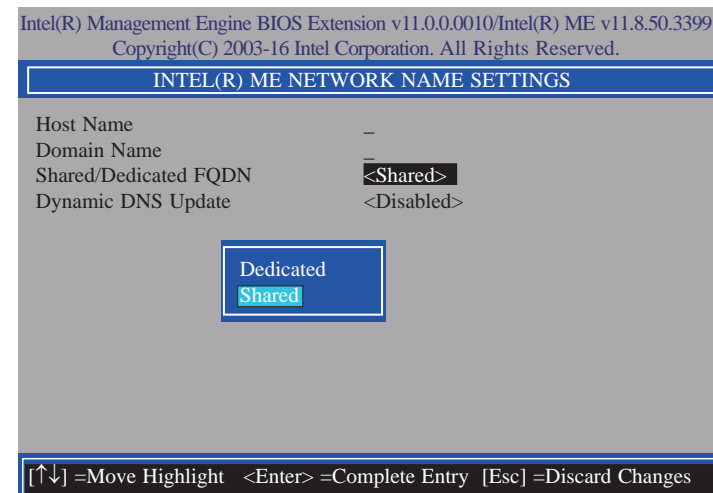

28. Select **Dynamic DNS Update** then press Enter. Select **Enabled** or **Disabled** then press Enter. If **Dynamic DNS Update** is set to **Enabled**, **Periodic Update Interval** and **TTL** fields will show up.

Intel(R) Management Engine BIOS Extension v11.0.0.0010/Intel(R) ME v11.8.50.3399
Copyright(C) 2003-16 Intel Corporation. All Rights Reserved.

INTEL(R) ME NETWORK NAME SETTINGS

Host Name -
Domain Name -
Shared/Dedicated FQDN <Shared>
Dynamic DNS Update <Disabled>

Disabled
Enabled

[↑↓] =Move Highlight <Enter> =Complete Entry [Esc] =Discard Changes

30. Select **TTL** then press Enter. Enter value then press Enter.

Intel(R) Management Engine BIOS Extension v11.0.0.0010/Intel(R) ME v11.8.50.3399
Copyright(C) 2003-16 Intel Corporation. All Rights Reserved.

INTEL(R) ME NETWORK NAME SETTINGS

Host Name -
Domain Name -
Shared/Dedicated FQDN <Shared>
Dynamic DNS Update <Enabled>
Periodic Update Interval 1440
TTL 900

Value in Seconds
900

<Enter> =Complete Entry [Esc] =Discard Changes

29. Select **Periodic Update Interval** then press Enter. Enter value then press Enter.

Intel(R) Management Engine BIOS Extension v11.0.0.0010/Intel(R) ME v11.8.50.3399
Copyright(C) 2003-16 Intel Corporation. All Rights Reserved.

INTEL(R) ME NETWORK NAME SETTINGS

Host Name -
Domain Name -
Shared/Dedicated FQDN <Shared>
Dynamic DNS Update <Enabled>
Periodic Update Interval 1440
TTL 900

Value=0 or >=20
1440

<Enter> =Complete Entry [Esc] =Discard Changes

31. Press Esc until you return to the **Intel(R) ME Network Setup** menu. Select **TCP/IP Settings** then press Enter. In the **TCP/IP Settings** menu, select **Wired LAN IPV4 Configuration** then press Enter.

Intel(R) Management Engine BIOS Extension v11.0.0.0010/Intel(R) ME v11.8.50.3399
Copyright(C) 2003-16 Intel Corporation. All Rights Reserved.

TCP/IP SETTINGS

> Wired LAN IPV4 Configuration

[↑↓] =Move Highlight [Enter] =Select Entry [Esc] =Exit

32. In the **Wired LAN IPv4 Configuration** menu, select **DHCP Mode** then press Enter. Select **Enabled** or **Disabled** then press Enter. If set to **Disabled**, **IPv4 Address**, **Subnet Mask Address**, **Default Gateway Address**, **Preferred DNS Address** and **Alternate DNS Address** will show up.

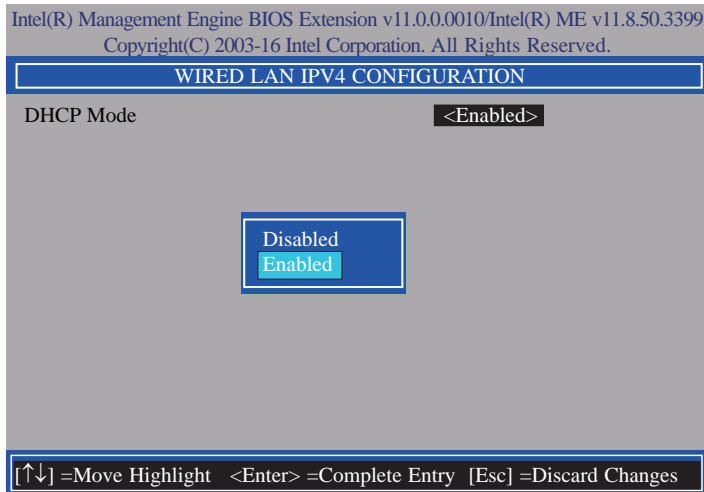

33. Select **IPv4 Address** then press Enter. Enter address then press Enter.

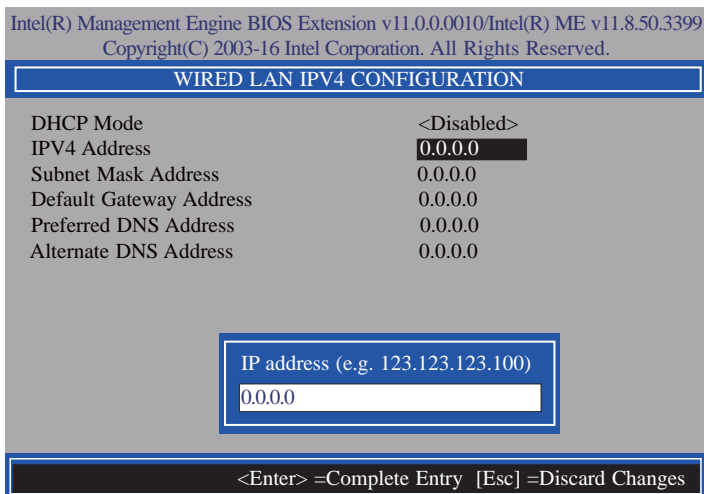

34. Select **Subnet Mask Address** then press Enter. Enter address then press Enter.

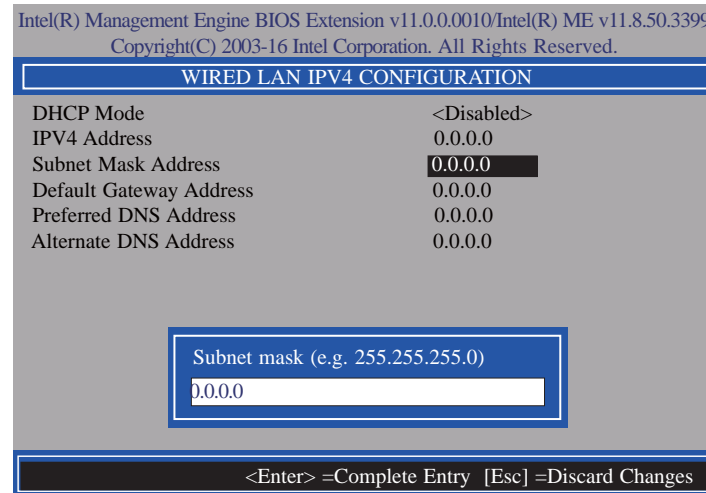

35. Select **Default Gateway Address** then press Enter. Enter address then press Enter.

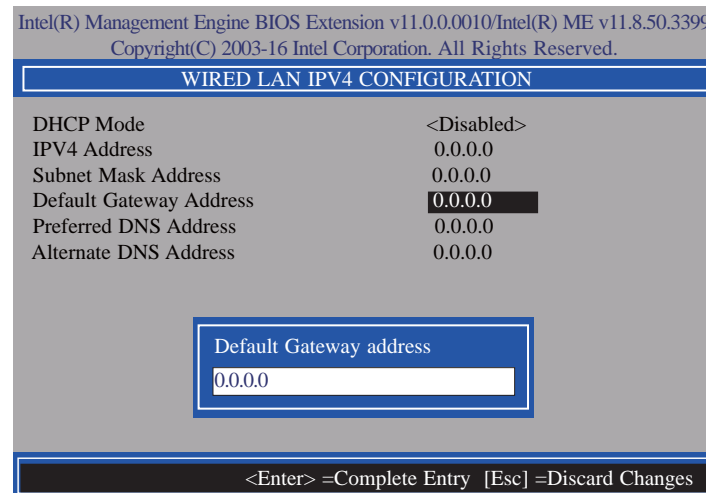

36. Select **Preferred DNS Address** then press Enter. Enter address then press Enter.

Intel(R) Management Engine BIOS Extension v11.0.0.0010/Intel(R) ME v11.8.50.3399
Copyright(C) 2003-16 Intel Corporation. All Rights Reserved.

WIRED LAN IPV4 CONFIGURATION

DHCP Mode	<Disabled>
IPV4 Address	0.0.0.0
Subnet Mask Address	0.0.0.0
Default Gateway Address	0.0.0.0
Preferred DNS Address	0.0.0.0
Alternate DNS Address	0.0.0.0

Preferred DNS address
0.0.0.0

<Enter> =Complete Entry [Esc] =Discard Changes

37. Select **Alternate DNS Address** then press Enter. Enter address then press Enter.

Intel(R) Management Engine BIOS Extension v11.0.0.0010/Intel(R) ME v11.8.50.3399
Copyright(C) 2003-16 Intel Corporation. All Rights Reserved.

WIRED LAN IPV4 CONFIGURATION

DHCP Mode	<Disabled>
IPV4 Address	0.0.0.0
Subnet Mask Address	0.0.0.0
Default Gateway Address	0.0.0.0
Preferred DNS Address	0.0.0.0
Alternate DNS Address	0.0.0.0

Alternate DNS address
0.0.0.0

<Enter> =Complete Entry [Esc] =Discard Changes

38. Press Esc until you return to the **Intel(R) AMT Configuration** menu. If you want to activate the current network settings and open the ME network interface, select **Activate Network Access**, press Enter, then press Y.

Intel(R) Management Engine BIOS Extension v11.0.0.0010/Intel(R) ME v11.8.50.3399
Copyright(C) 2003-16 Intel Corporation. All Rights Reserved.

INTEL(R) AMT CONFIGURATION

Manageability Feature Selection	<Enabled>
> SOL/Storage Redirection/KVM	
> User Consent	
Password Policy	<Anytime>
> Network Setup	
Activate Network Access	
Unconfigure Network Access	<Full Unprovision>
> Remote Setup And Configuration	
> Power Control	

Activates the current network settings and opens the ME network interface
Continue: (Y/N)

[↑↓] =Move Highlight [Enter] =Select Entry [Esc] =Exit

39. In the **Intel(R) AMT Configuration** menu, select **Unconfigure Network Access** then press Enter.

Intel(R) Management Engine BIOS Extension v11.0.0.0010/Intel(R) ME v11.8.50.3399
Copyright(C) 2003-16 Intel Corporation. All Rights Reserved.

INTEL(R) AMT CONFIGURATION

Manageability Feature Selection	<Enabled>
> SOL/Storage Redirection/KVM	
> User Consent	
Password Policy	<Anytime>
> Network Setup	
Activate Network Access	
Unconfigure Network Access	<Full Unprovision>
> Remote Setup And Configuration	
> Power Control	

Full Unprovision

[↑↓] =Move Highlight <Enter> =Complete Entry [Esc] =Discard Changes

40. In the **Intel(R) AMT Configuration** menu, select **Remote Setup And Configuration** then press Enter.

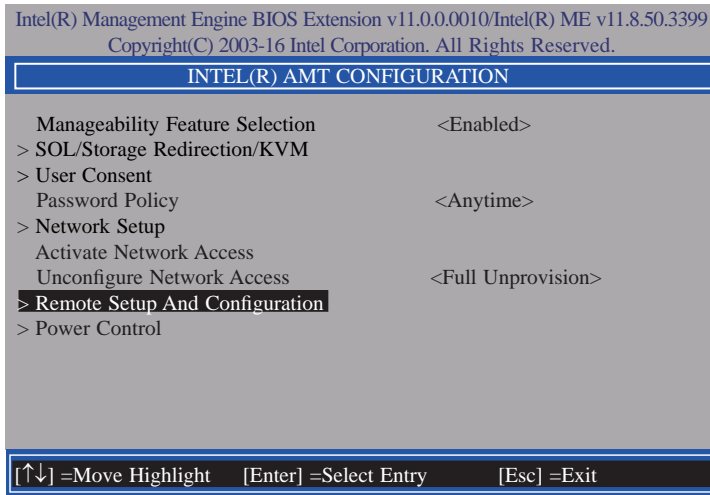

42. In the **Intel(R) Remote Setup And Configuration** menu, select **Provisioning Record** then press Enter.

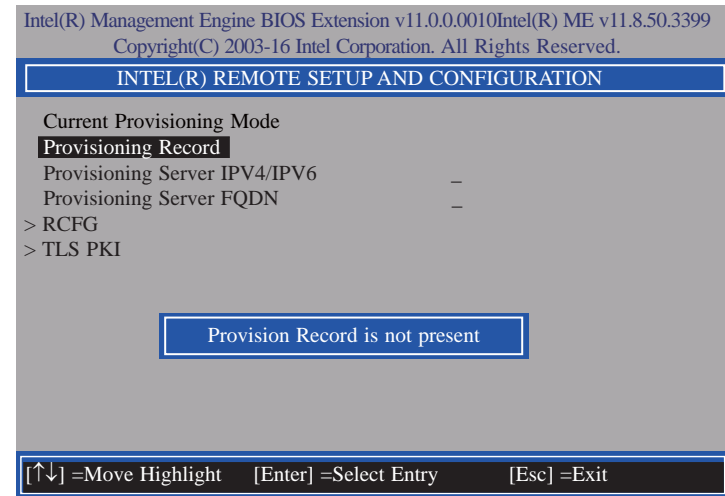

41. In the **Intel(R) Remote Setup And Configuration** menu, select **Current Provisioning Mode** then press Enter.

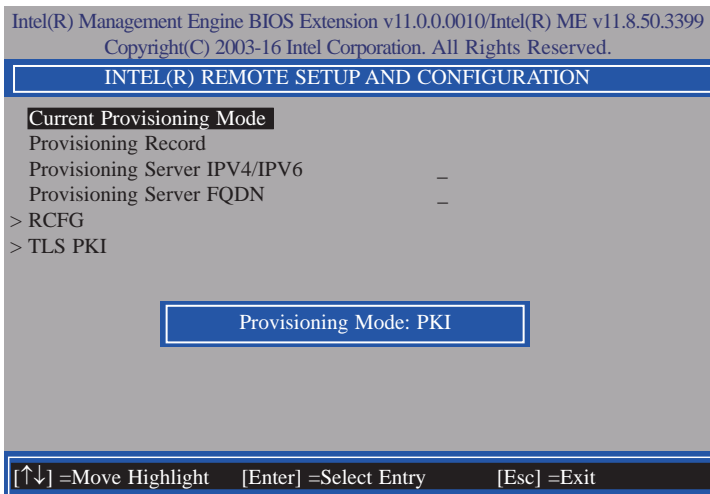

43. In the **Intel(R) Remote Setup And Configuration** menu, select **Provisioning Server IPV4/IPV6** then press Enter. Enter the address then press Enter.

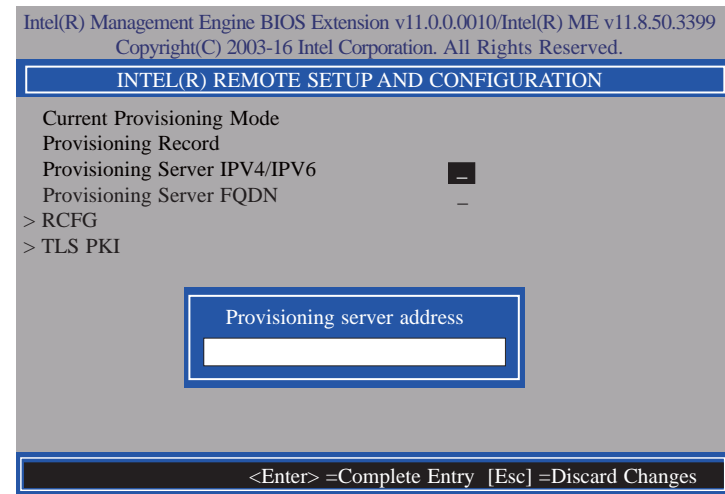

44. In the **Intel(R) Remote Setup And Configuration** menu, select **Provisioning Server FQDN** then press Enter. Enter the FQDN then press Enter.

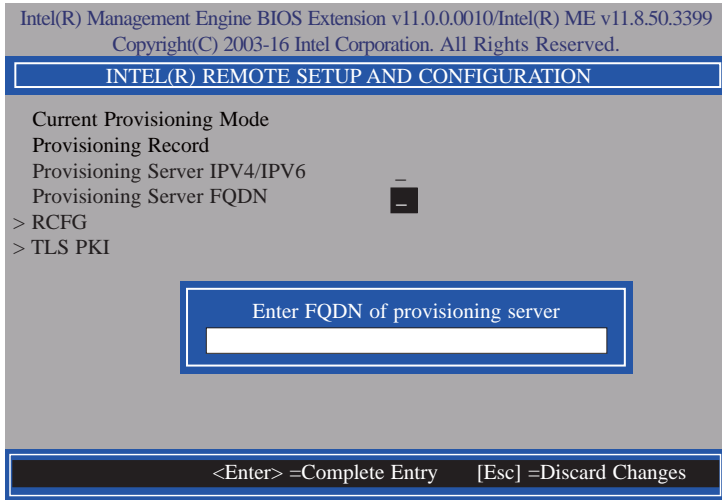

46. Press Esc until you return to the **Intel(R) Remote Setup And Configuration** menu. Select **TLS PKI** then press Enter. Select **Remote Configuration **** then press Enter. Select **Enabled** or **Disabled** then press Enter.

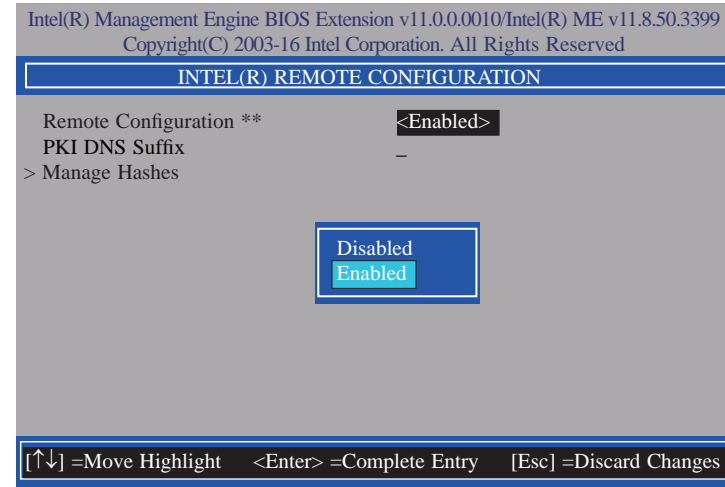

45. If you want to activate remote configuration, in the **Intel(R) Remote Setup And Configuration** menu, select **RCFG** then press Enter. Select **Start Configuration** then press Enter. Press Y to activate.

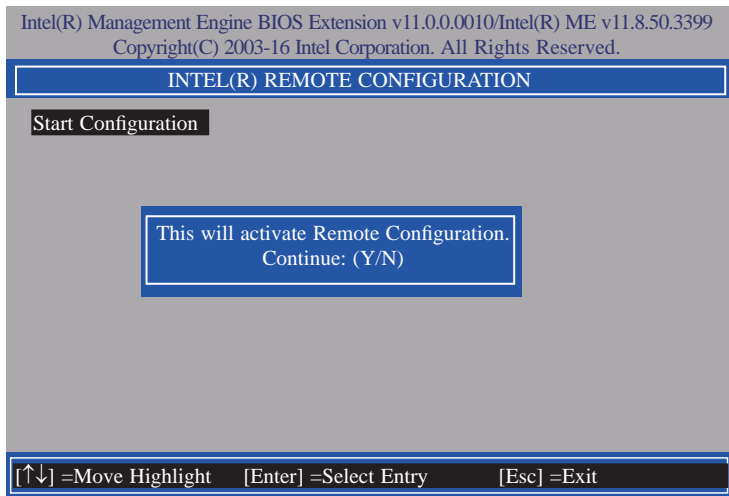

47. Select **PKI DNS Suffix** then press Enter. Enter the PKI DNS Suffix then press Enter.

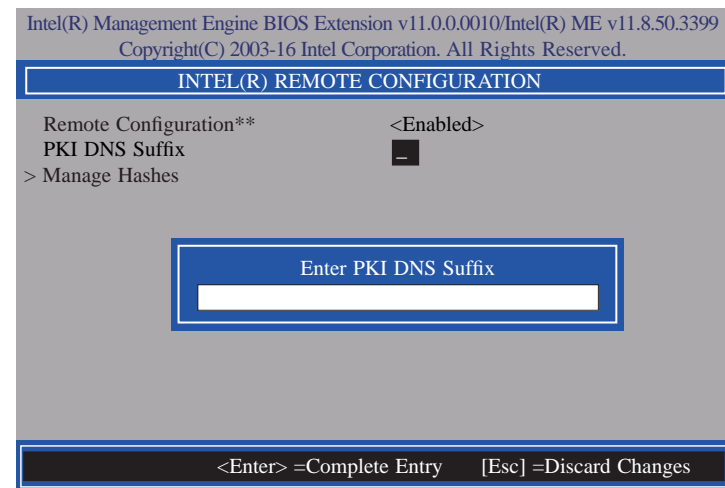

48. In the **Intel(R) Remote Configuration** menu, select **Manage Hashes** then press Enter. Select the hash name then press Insert to enter custom hash certificate name, press Delete to delete hash, press Enter to view hash information, press + to activate or deactivate hash, and press Esc to exit.

Intel(R) Management Engine BIOS Extension v11.0.0.0010/Intel(R) ME v11.8.50.3399
Copyright(C) 2003-16 Intel Corporation. All Rights Reserved.

INTEL(R) REMOTE CONFIGURATION

Hash Name	Active	Default	Algorithm
VeriSign Class 3	Active: [*]	Default: [*]	SHA256
VeriSign Class 3	Active: [*]	Default: [*]	SHA256
Go Daddy Class 2	Active: [*]	Default: [*]	SHA256
Comodo AAA CA	Active: [*]	Default: [*]	SHA256
Starfield Class 2	Active: [*]	Default: [*]	SHA256
VeriSign Class 3	Active: [*]	Default: [*]	SHA256
VeriSign Class 3	Active: [*]	Default: [*]	SHA256
VeriSign Class 3	Active: [*]	Default: [*]	SHA256
GTE CyberTrust G1	Active: [*]	Default: [*]	SHA256
Baltimore Cyber Tr	Active: [*]	Default: [*]	SHA256
Cyber Trust Global	Active: [*]	Default: [*]	SHA256
Verizon Global Ro	Active: [*]	Default: [*]	SHA256
Entrust. net CA (2	Active: [*]	Default: [*]	SHA256
Entrust Root CA	Active: [*]	Default: [*]	SHA256
VeriSign Universa	Active: [*]	Default: [*]	SHA256
Go Daddy Root CA	Active: [*]	Default: [*]	SHA256
Entrust Root CA -	Active: [*]	Default: [*]	SHA256
Startfield Root CA	Active: [*]	Default: [*]	SHA256

[Ins] =Add New Hash [Delete] =Delete Hash [+] =Activate Hash
[↑↓] =Move Highlight [Enter] =View Hash [Esc] =Exit

49. Press Esc until you return to the **Intel(R) AMT Configuration** menu, select **Power Control** then press Enter. In the **Intel(R) AMT Power Control** menu, select **Intel(R) AMT ON in Host Sleep States** then press Enter. Select an option then press Enter.

Intel(R) Management Engine BIOS Extension v11.0.0.0010/Intel(R) ME v11.8.50.3399
Copyright(C) 2003-16 Intel Corporation. All Rights Reserved.

INTEL(R) AMT POWER CONTROL

These configurations are effective only after AMT provisioning has started

Intel(R) AMT ON in Host Sleep States <Desktop: ON in S0, ME Wake in S3, S4-5>

Idle Timeout 65535

Desktop: ON in S0
Desktop: ON in S0, ME Wake in S3, S4-5

[↑↓] =Move Highlight <Enter> =Complete Entry [Esc] =Discard Changes

50. In the **Intel(R) AMT Power Control** menu, select **Idle Timeout** then press Enter. Enter the timeout value and press Enter.

Intel(R) Management Engine BIOS Extension v11.0.0.0010/Intel(R) ME v11.8.50.3399
Copyright(C) 2003-16 Intel Corporation. All Rights Reserved.

INTEL(R) AMT POWER CONTROL

This configurations are effective only after AMT provisioning has started

Intel(R) AMT ON in Host Sleep States <Desktop: ON in S0, ME Wake in S3, S4-5>

Idle Timeout 65535

Timeout Value (1-65535)
65535

<Enter> =Complete Entry [Esc] =Discard Changes

51. Press Esc until you return to the **Main Menu**. Select **MEBx Exit** then press Enter. Press Y to exit.

Intel(R) Management Engine BIOS Extension v11.0.0.0010/Intel(R) ME v11.8.50.3399
Copyright(C) 2003-16 Intel Corporation. All Rights Reserved

MAIN MENU

> Intel(R) ME General Settings
> Intel(R) AMT Configuration
MEBx Exit

Are you sure you want to exit?(Y/N):

Exit

[↑↓] =Move Highlight [Enter] =Select Entry [Esc] =Exit