

AL253

4"SBC Industrial Motherboard
User's Manual

Copyright

This publication contains information that is protected by copyright. No part of it may be reproduced in any form or by any means or used to make any transformation/adaptation without the prior written permission from the copyright holders.

This publication is provided for informational purposes only. The manufacturer makes no representations or warranties with respect to the contents or use of this manual and specifically disclaims any express or implied warranties of merchantability or fitness for any particular purpose. The user will assume the entire risk of the use or the results of the use of this document. Further, the manufacturer reserves the right to revise this publication and make changes to its contents at any time, without obligation to notify any person or entity of such revisions or changes.

Changes after the publication's first release will be based on the product's revision. The website will always provide the most updated information.

© 2022. All Rights Reserved.

Trademarks

Product names or trademarks appearing in this manual are for identification purpose only and are the properties of the respective owners.

FCC and DOC Statement on Class B

This equipment has been tested and found to comply with the limits for a Class B digital device, pursuant to Part 15 of the FCC rules. These limits are designed to provide reasonable protection against harmful interference when the equipment is operated in a residential installation. This equipment generates, uses and can radiate radio frequency energy and, if not installed and used in accordance with the instruction manual, may cause harmful interference to radio communications. However, there is no guarantee that interference will not occur in a particular installation. If this equipment does cause harmful interference to radio or television reception, which can be determined by turning the equipment off and on, the user is encouraged to try to correct the interference by one or more of the following measures:

- Reorient or relocate the receiving antenna.
- Increase the separation between the equipment and the receiver.
- Connect the equipment into an outlet on a circuit different from that to which the receiver is connected.
- Consult the dealer or an experienced radio TV technician for help.

Notice:

1. The changes or modifications not expressly approved by the party responsible for compliance could void the user's authority to operate the equipment.
2. Shielded interface cables must be used in order to comply with the emission limits.

Table of Contents

Chapter 1 - Introduction.....	6
Specifications	6
Chapter 2 - Hardware Installation.....	7
Board Layout.....	7
LEDs	7
System Memory	8
Installing the SO-DIMM Module	8
Jumper Settings.....	10
Power On Select (JP7).....	10
Front Panel (JP1).....	10
COM Serial / DIO Switch (JP8/JP9)	11
SW4.....	11
I/O Ports.....	12
Graphics Display.....	12
USB Ports.....	12
RJ45 LAN Ports.....	13
COM (Serial) / DIO Port (DB9).....	13
9~36V DC-In.....	14
SATA (Serial ATA) Connectors.....	14
Battery	15
Chassis Intrusion.....	15
Expansion Slots	16
Installing the Mini PCIe Module	16
Installing SIM Card	17
Chapter 3 - BIOS Settings.....	18
Overview	18
Main.....	19
Advanced	19
ACPI Configuration.....	20
Audio Configuration.....	21
SATA Configuration	21
PCI Express Configuration	22
Console Redirection	22
SIO NUVOTON6116D.....	23
NCT6116D HW Monitor	24
LAN Configuration	25
Security	26
Boot	26
Save & Exit.....	27
Updating the BIOS.....	27
Notice: BIOS SPI ROM.....	27

About this Manual

This manual can be retrieved from the website.

The manual is subject to change and update without notice, and may be based on editions that do not resemble your actual products. Please visit our website or contact our sales representatives for the latest editions.

Warranty

1. Warranty does not cover damages or failures that arises from misuse of the product, inability to use the product, unauthorized replacement or alteration of components and product specifications.
2. The warranty is void if the product has been subjected to physical abuse, improper installation, modification, accidents or unauthorized repair of the product.
3. Unless otherwise instructed in this user's manual, the user may not, under any circumstances, attempt to perform service, adjustments or repairs on the product, whether in or out of warranty. It must be returned to the purchase point, factory or authorized service agency for all such work.
4. We will not be liable for any indirect, special, incidental or consequential damages to the product that has been modified or altered.

About the Package

The package contains the following items. If any of these items are missing or damaged, please contact your dealer or sales representative for assistance.

- One AL253 motherboard
- Heat Sink
- Serial ATA data with power cable

The system and accessories in the package may not come similar to the information listed above. This may differ in accordance with the sales region or models in which it was sold. For more information about the standard package in your region, please contact your dealer or sales representative.

Optional Items

- USB port cable
- COM port cable
- Power adapter
- Heat spreader

The system and accessories in the package may not come similar to the information listed above. This may differ in accordance with the sales region or models in which it was sold. For more information about the standard package in your region, please contact your dealer or sales representative.

Screw Type

- Din Rail Kit - type M3, length 5mm, amount: 3.
- Wall mount kit - type M4, length 10mm, amount: 4.
- VESA mount kit - type M4, length 10mm, amount: 4 & type M3, length 6mm, amount: 4.

Static Electricity Precautions

It is quite easy to inadvertently damage your PC, system board, components or devices even before installing them in your system unit. Static electrical discharge can damage computer components without causing any signs of physical damage. You must take extra care in handling them to ensure against electrostatic build-up.

1. To prevent electrostatic build-up, leave the system board in its anti-static bag until you are ready to install it.
2. Wear an antistatic wrist strap.
3. Do all preparation work on a static-free surface.
4. Hold the device only by its edges. Be careful not to touch any of the components, contacts or connections.
5. Avoid touching the pins or contacts on all modules and connectors. Hold modules or connectors by their ends.



Important:

Electrostatic discharge (ESD) can damage your processor, disk drive and other components. Perform the upgrade instruction procedures described at an ESD workstation only. If such a station is not available, you can provide some ESD protection by wearing an antistatic wrist strap and attaching it to a metal part of the system chassis. If a wrist strap is unavailable, establish and maintain contact with the system chassis throughout any procedures requiring ESD protection.

Safety Precautions

- Use the correct DC / AC input voltage range.
- Unplug the power cord before removing the system chassis cover for installation or servicing. After installation or servicing, cover the system chassis before plugging in the power cord.
- There is danger of explosion if battery incorrectly replaced.
- Replace only with the same or equivalent specifications of batteries recommend by the manufacturer.
- Dispose of used batteries according to local ordinance.
- Keep this system away from humid environments.
- Make sure the system is placed or mounted correctly and stably to prevent the chance of dropping or falling may cause damage.
- The openings on the system shall not be blocked and shall be kept in distance from

other objects to make sure of proper air ventilation to protect the system from over-heating.

- Dress the cables, especially the power cord, so they will not be stepped on, in contact with high temperature surfaces, or cause any tripping hazards.
- Do not place anything on top of the power cord. Use a power cord that has been approved for use with the system and is compliant with the voltage and current ranges required by the system's electrical specifications.
- If the system is to be unused or stored for a long time, disconnect it from the power source to avoid damage by transient overvoltage.
- If one of the following occurs, consult a service personnel:
 - The power cord or plug is damaged.
 - Liquid has penetrated the system.
 - The system has been exposed to moisture.
 - The system is not working properly.
 - The system is physically damaged.
- The unit uses a three-wire ground cable which is equipped with a third pin to ground the unit and prevent electric shock. Do not defeat the purpose of this pin. If your outlet does not support this kind of plug, contact your electrician to replace the outlet.
- Disconnect the system from the electricity outlet before cleaning. Use a damp cloth for cleaning the surface. Do not use liquid or spray detergents for cleaning.
- Before connecting, make sure that the power supply voltage is correct. The device is connected to a power outlet which should be grounded connection.



The system may burn fingers while running.

Wait for 30 minutes to handle electronic parts after power off.

Chapter 1 - Introduction

► Specifications

SYSTEM	Processor	Intel Atom® Processor E3900 Series, BGA 1296 Intel Atom® x7-E3950 Processor, Quad Core, 2M Cache, 1.6GHz (2.0GHz), 12W Intel Atom® x5-E3940 Processor, Quad Core, 2M Cache, 1.6GHz (1.8GHz), 9.5W Intel Atom® x5-E3930 Processor, Dual Core, 2M Cache, 1.3GHz (1.8GHz), 6W Intel® Pentium® Processor N4200E, Quad Core, 2M Cache, 1.1GHz (2.5GHz), 6W
	Memory	2GB/4GB/8GB Memory onboard + one 204-pin SO-DIMM Dual Channel DDR3L 1866MHz The system supports a combined maximum memory size of 8GB total.
	BIOS	AMI SPI 128Mbit (support UEFI/legacy mode)
	GRAPHICS	Controller
Feature		OpenGL 4.2, Direct X 11.1, OpenCL 1.2, OGL ES 3.0 HW Decode: H.264, MPEG2, VC1, VP8, H.265, MPEG4 HW Encode: H.264, MPEG2, MPEG4
Display		1 x DP/HDMI (auto-detection) 1 x VGA/DP DP: resolution up to 4096x2160 @ 60Hz HDMI: resolution up to 3840x2160 @ 30Hz VGA: resolution up to 1920x1200 @ 60Hz
Dual Displays		DP++/HDMI + VGA/DP
STORAGE	eMMC	1 x 8G/16G/32G/64G (opt.)
EXPANSION	Interface	1 x Full-size mSATA (SATA/LPC, USB is available by BOM option) 1 x Full-size Mini PCIe (USB2.0/reset/nano-SIM, PCIe is available for config. with 4 LAN) 1 x M.2 (2230 E Key) (PCIe/USB2.0)
	ETHERNET	Controller 4 x Intel® I211AT PCIe, co-lay with I210IT (10/100/1000Mbps)
LED	Indicators	1 x Power LED 1 x Status LED
REAR I/O	Ethernet	up to 4 x GbE (RJ-45) (1 x GbE colay 2 x USB 3.0)
	Serial	4 x RS-232/422/485 (1 x RS-232/422/485 colay 1 x 8-bit DIO by jumper setting)
	USB	up to 4 x USB 3.0 (2 x USB 3.0 colay 1 x GbE) Support up to USB 3.0 Super Speed
	Display	1 x DP++/HDMI (auto-detection) 1 x VGA/DP

INTERNAL I/O	USB	2 x USB 2.0 (2.0mm pitch)
	SATA	1 x SATA 3.0 (up to 6Gb/s, support SSD only) 1 x SATA Power
	DIO	1 x 8-bit DIO
	Other I/O	1 x Front Panel
WATCHDOG TIMER	Output & Interval	System Reset, Programmable via Software from 1 to 255 Seconds
SECURITY	TPM	fTPM2.0
POWER	Type	9~36V DC input
	Connector	DC Jack
	Consumption	TBD
	RTC Battery	CR2032 Coin Cell, link main board with cable
OS SUPPORT	Microsoft/ Linux	Windows 10 IoT Enterprise 64-bit Windows 7 (/WES7) 32/64-bit (project support only) Linux
	ENVIRONMENT	Temperature
Humidity		Operating: 5 to 90% RH Storage: 5 to 90% RH
MTBF		TBD
MECHANICAL	Dimensions	4" SBC Form Factor 165mm (6.49") x 115mm (4.53")
	Height	PCB: 1.6mm Top Side: TBD, Bottom Side: TBD
STANDARD AND CERTIFICATIONS	Certification	CE, FCC, RoHS, UKCA



The specifications listed here may be based on editions that do not resemble your actual products. Please visit the download page at go.dfi.com/AL253, or via the QR code to the right for the latest datasheet.

Chapter 2 - Hardware Installation

► **Board Layout**

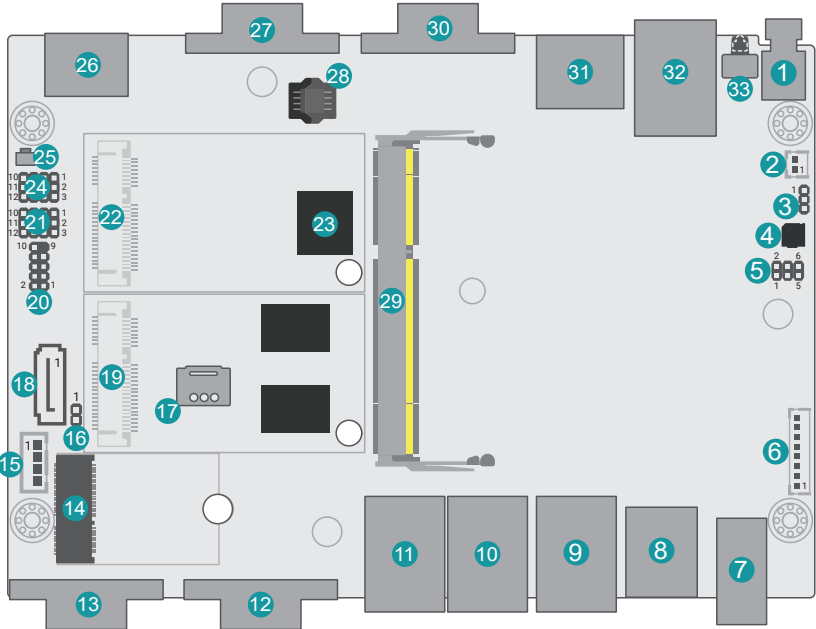

- | | | |
|-----------------------|----------------------|-----------------------|
| 23 eMMC | 12 COM4 | 1 Power Button |
| 24 JP9 | 13 COM3/DIO | 2 Battery |
| 25 SW4 | 14 M.2 E Key 2230 | 3 JP7 |
| 26 VGA | 15 SATA Power | 4 Buzzer |
| 27 COM1 | 16 J15 | 5 JP1 |
| 28 SPI Flash BIOS | 17 Nano SIM | 6 36VDC In (reserved) |
| 29 DDR3L | 18 SATA | 7 9~36V DC-In |
| 30 COM2 | 19 Mini PCIe 2 | 8 2 x USB 3.0 |
| 31 HDMI/DP | 20 USB 6/7 (USB 2.0) | 9 2 x USB 3.0 or LAN4 |
| 32 LAN3 (optional) | 21 JP8 | 10 LAN2 |
| 33 Reset & Status LED | 22 Mini PCIe 1 | 11 LAN1 |

Important: Electrostatic discharge (ESD) can damage your board, processor, disk drives, add-in boards, and other components. Perform installation procedures at an ESD workstation only. If such a station is not available, you can provide some ESD protection by wearing an antistatic wrist strap and attaching it to a metal part of the system chassis. If a wrist strap is unavailable, establish and maintain contact with the system chassis throughout any procedures requiring ESD protection.

► **LEDs**

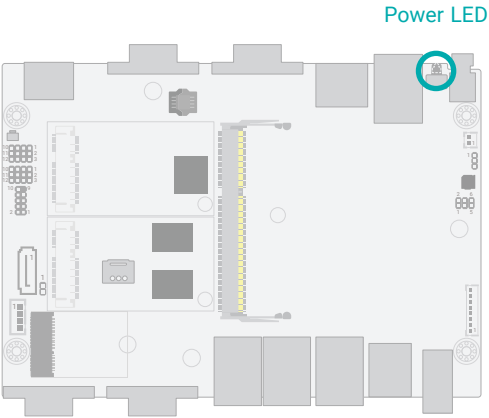

Important: When the Standby Power LED lights up, it indicates that there is power on the system board. Power-off the PC then unplug the power cord prior to installing any devices. Failure to do so will cause severe damage to the motherboard and components.

► **System Memory**

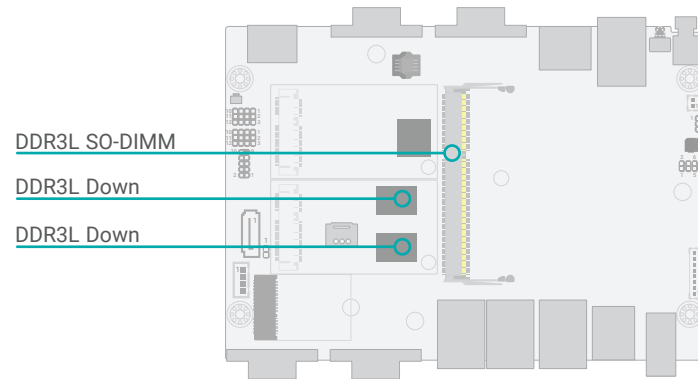

The system board supports the following memory interface.

Single Channel (SC)

Data will be accessed in chunks of 64 bits from the memory channels.

Features

- 2G/4G/8G DDR3L Memory Down
- One SO-DIMM Memory up to 8GB
- Single Channel DDR3L

Installing the SO-DIMM Module

Before installing the memory module, please make sure that the following safety cautions are well-attended.

1. Make sure the PC and all other peripheral devices connected to it has been powered down.
2. Disconnect all power cords and cables.
3. Locate the SO-DIMM socket on the system board
4. Make sure the notch on memory card is aligned to the key on the socket.



◀◀◀ **DDR3 SO-DIMM**



◀◀◀ **Socket Top View**

► System Memory

Please follow the steps below to install the memory card into the socket.

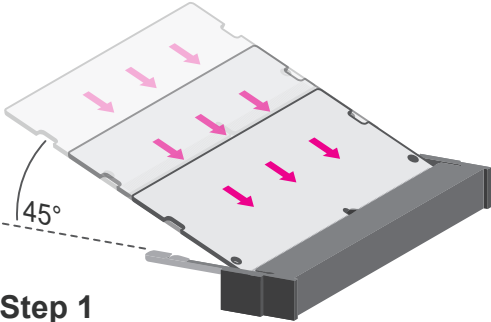

Step 1:
Insert the memory card into the slot while making sure 1) the notch and the key are aligned, and 2) the non-connector end rises approximately 45 degrees horizontally. Press the card firmly into the socket while applying and maintaining even pressure on both ends.

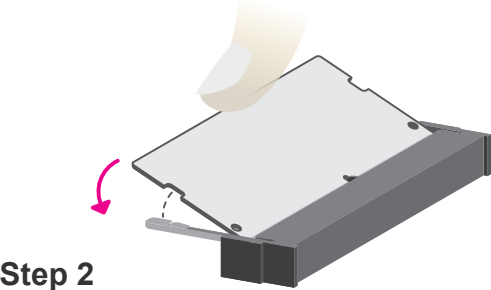

Step 2:
Press the end of the card far from the socket down while making sure the retention notch and the clip align as indicated by the dotted line in the illustration. If the retention notch and the clip do not align, please remove the card and re-insert it. Press the card all the way down.

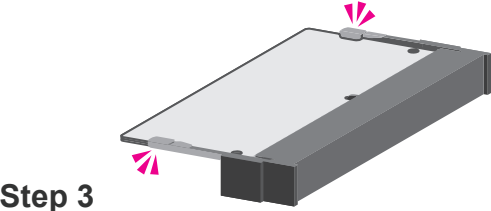

Step 3:
The clips snap automatically and abruptly to the retention notches of the card sounding a distinctive click, and lock the card in place. Inspect that the clip sits in the notch. If not, please pull the clips outward, release and remove the card, and mount it again.

► **Jumper Settings**

Power On Select (JP7)

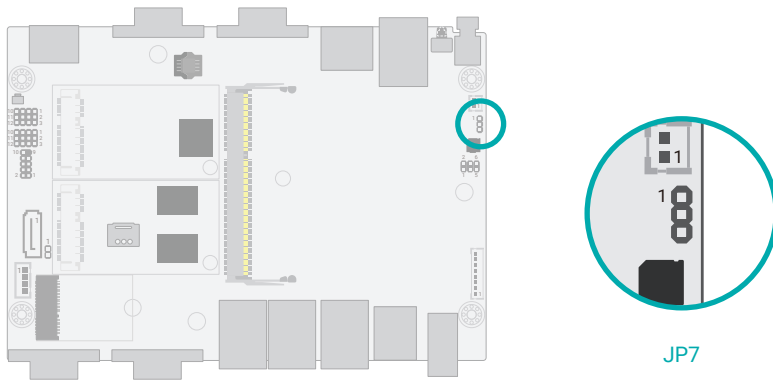

JP7



■ 1-2 On: Power On via Power Button (default)



■ 2-3 On: Auto Power On via DC In

The jumper allows you to choose between system power-on via power button and automatic power-on via DC power in.

► **Jumper Settings**

Front Panel (JP1)

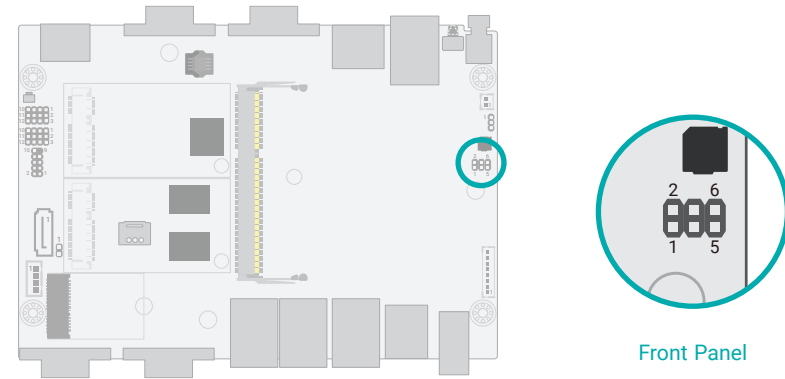

Front Panel

■ **Front Panel Pin Assignment**

Pin	Assignment	Pin	Assignment
1	Power Button	2	SUS LED PWR
3	GND	4	SUS LED
5	Reset	6	SATA LED

▶ Jumper Settings

COM Serial / DIO Switch (JP8/JP9)

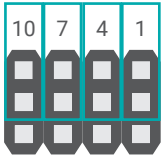
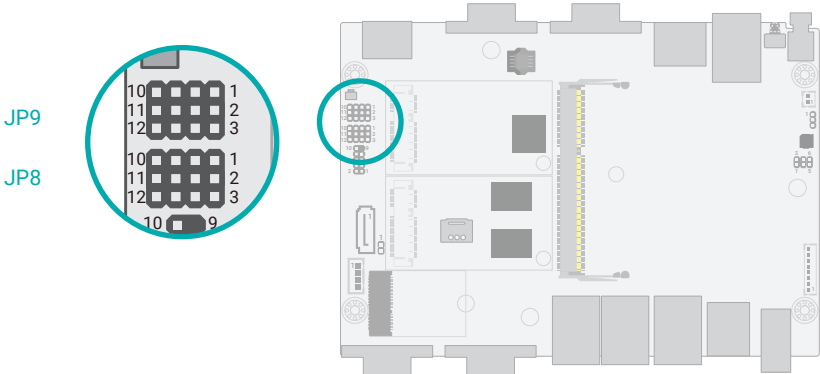

■ Serial COM Signal

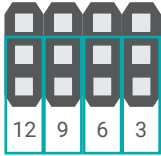

■ DIO Signal

The COM3 / DIO port is a DB9 connector and can be used as a COM Serial port or a DIO port (8-bit GPIO). Both JP8 and JP9 shall be configured concurrently when switching between the two modes.

▶ Jumper Settings

SW4

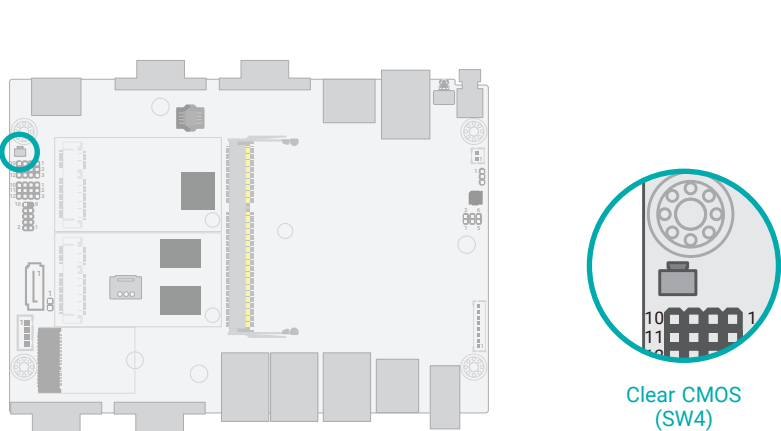

If any anomaly of the followings is encountered –

- a) CMOS data is corrupted;
- b) you forgot the supervisor or user password;
- c) failure to start the system due to BIOS mis-configuration

– it is suggested that the system be reconfigured with default values stored in the ROM BIOS. To load the default values stored in the ROM BIOS, please follow the steps below.

1. Power-off the system and unplug the power cord.
2. Press SW4 for a few seconds.
3. Plug the power cord back in and power on the system.

I/O Ports

Graphics Display

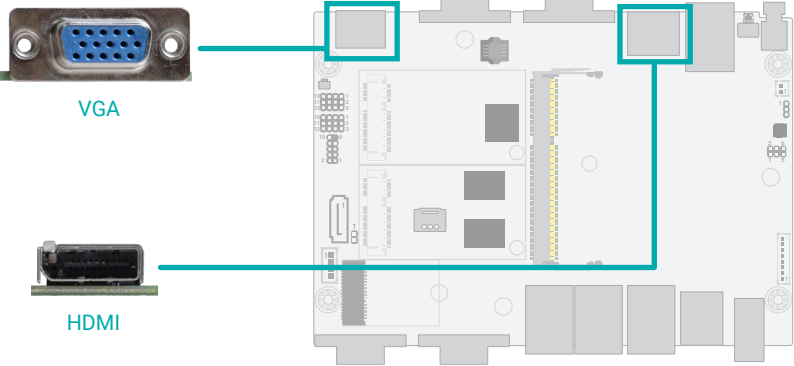

HDMI
 The HDMI port which carries both digital audio and video signals is used to connect a LCD monitor or digital TV that has the HDMI port.

DisplayPort ++
 The DisplayPort (DP) is a digital display interface used to connect a display device such as a computer monitor. It is used to transmit audio and video simultaneously. The interface, which is developed by VESA, delivers higher performance features than any other digital interface. DP++ is supported by the system board for converting to DVI and HDMI signals.

VGA
 The VGA port is used for connecting a VGA monitor. Connect the monitor's 15-pin D-shell cable connector to the VGA port. After you plug the monitor's cable connector into the VGA port, gently tighten the cable screws to hold the connector in place.

Important:
 Please be cautious when inserting an HDMI cable into the HDMI/DP port. The HDMI male connector shall align to the left of the port as illustrated here. The insertion is fairly effortless and please refrain from forcing the insertion to prevent damage.

USB Ports

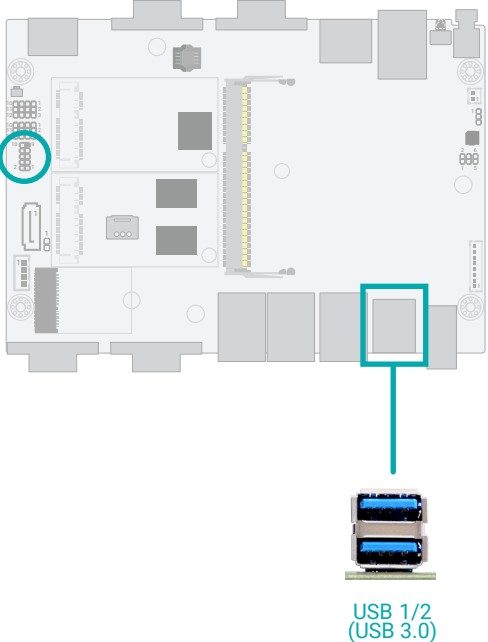

USB allows data exchange between your computer and a wide range of simultaneously accessible external Plug and Play peripherals. The system board is equipped with multiple USB Type A ports at the front panel – two USB 3.0 or four USB 3.0 ports – along with two internal USB 2.0 pin-header ports.

Wake-On-USB Keyboard/Mouse
 The Wake-On-USB Keyboard/Mouse function allows you to use a USB keyboard or USB mouse to wake up a system from the S3 (STR - Suspend To RAM) state.

BIOS Setting
 Configure USB devices in the Advanced menu ("USB Configuration" submenu) of the BIOS. Refer to Chapter 3 for more information.

Important:
 The USB 2.0 header can be optional removed in stock settings to transmit USB 7 signals through mSATA.

I/O Ports

RJ45 LAN Ports

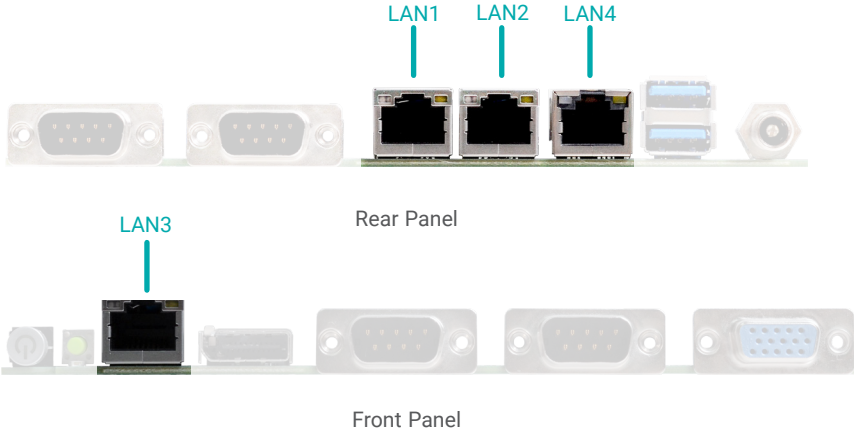

The LAN port allows the system board to connect to a local area network by means of a network hub.

BIOS Setting

Configure the onboard LAN ports in the Advanced menu ("ACPI Configuration" submenu) of the BIOS. Refer to the chapter 3 for more information.

Driver Installation

Install the LAN drivers. Refer to the chapter 4 for more information.

Features

- 2 or 4 x Intel® I210IT PCIe (10/100/1000Mbps)

I/O Ports

COM (Serial) / DIO Port (DB9)

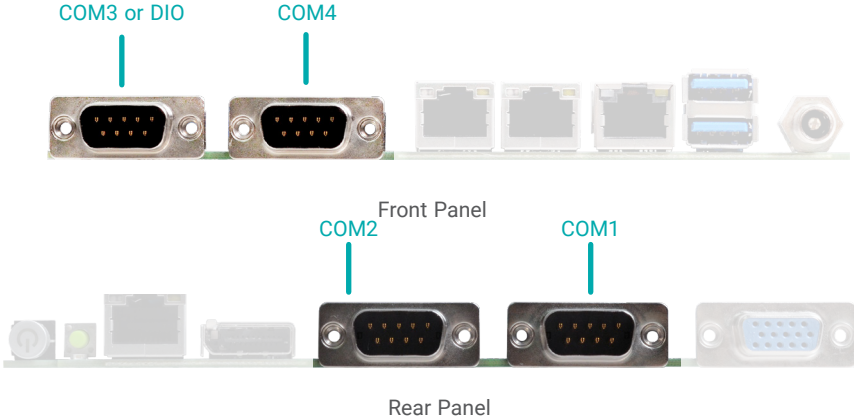

The serial ports are asynchronous communication ports with 16C550A-compatible UARTs that can be used with modems, serial printers, remote display terminals, and other serial devices.

Jumper Setting

Configure the signal of COM3 / DIO port via jumper settings of JP8 and JP9.

BIOS Setting

Configure the COM ports including its communication mode in the Advanced menu ("Super IO Configuration" submenu) of the BIOS. Refer to Chapter 3 for more information.

■ COM Pin Assignment

Pin	RS232	RS422	RS485
1	DCD-	RXD+	Data+
2	RD	RXD-	Data-
3	TD	TXD+	N.C.
4	DTR-	TXD-	N.C.
5	GND	GND	GND
6	DSR-	N.C.	N.C.
7	RTS-	N.C.	N.C.
8	CTS-	N.C.	N.C.
9	RI-	N.C.	N.C.

■ DIO Pin Assignment

Pin	Assignment	Pin	Assignment
1	DIOA0	2	DIOA1
3	DIOA2	4	DIOA3
5	GND	6	DIOA6
7	DIOA7	8	DIOA4
9	DIOA5		

I/O Ports

9~36V DC-In

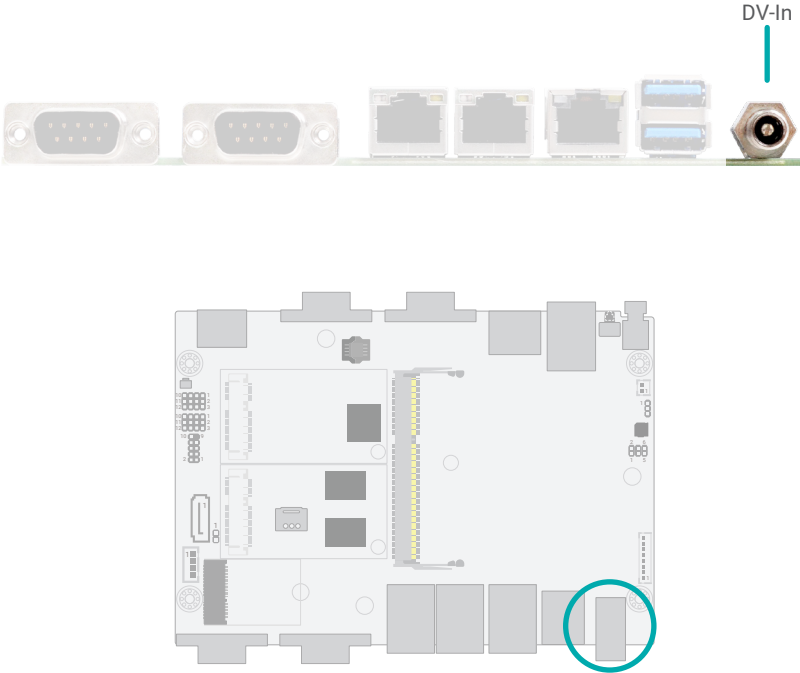

The 9~36V DC-In coaxial supports wide-range voltage power connection.



Important: Insufficient power supplied to the system may result in instability or malfunction of the add-in boards and peripherals. Calculating the system's approximate power usage is important to ensure that the power supply meets the system's consumption requirements.

I/O Ports

SATA (Serial ATA) Connectors

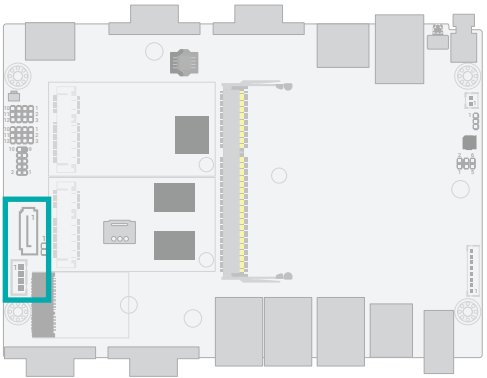

The Serial ATA (SATA) connectors are used to connect the Serial ATA device. SATA 3.0 is supported by the five SATA ports and provides data rate up to 6Gb/s. Connect one end of the Serial ATA cable to a SATA connector and the other end to your Serial ATA device.

BIOS Setting

Configure the Serial ATA drives in the Advanced menu ("SATA Configuration" submenu) of the BIOS. Refer to chapter 3 for more information.



■ SATA 3.0 Pin Assignment

■ SATA Power Pin Assignment

I/O Ports

Battery

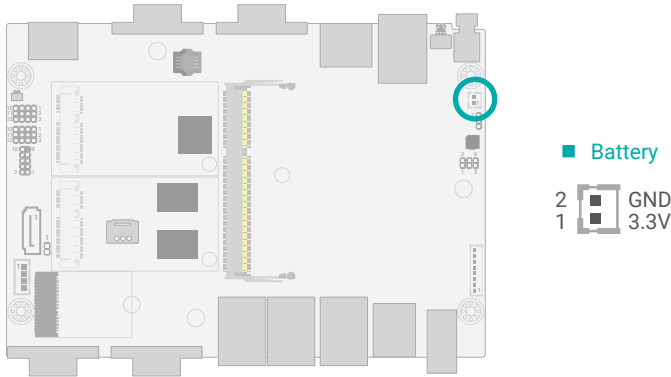

■ External Battery

The external lithium ion battery supplies power to the real-time clock and CMOS memory as an auxiliary source of power when the main power is shut off.

Safety Measures

- There exists explosion hazard if the battery is incorrectly installed.
- Replace only with the same or equivalent type recommended by the manufacturer.
- Dispose of used batteries according to local ordinances.

I/O Ports

Chassis Intrusion



■ Chassis Intrusion

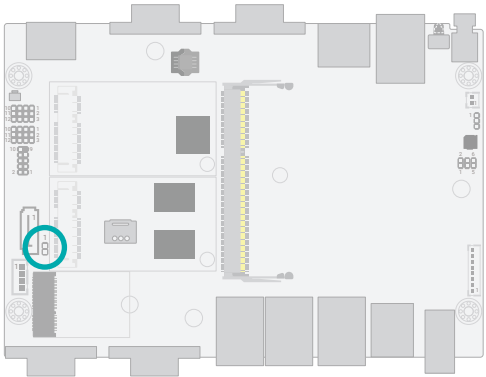

■ Chassis Intrusion Pin Assignment

Pin	Assignment	Pin	Assignment
1	Signal	2	GND

The board supports the chassis intrusion detection function. Connect the chassis intrusion sensor cable from the chassis to this connector. When the system's power is on and a chassis intrusion occurred, an alarm will sound. When the system's power is off and a chassis intrusion occurred, the alarm will sound only when the system restarts.

► I/O Ports

Expansion Slots

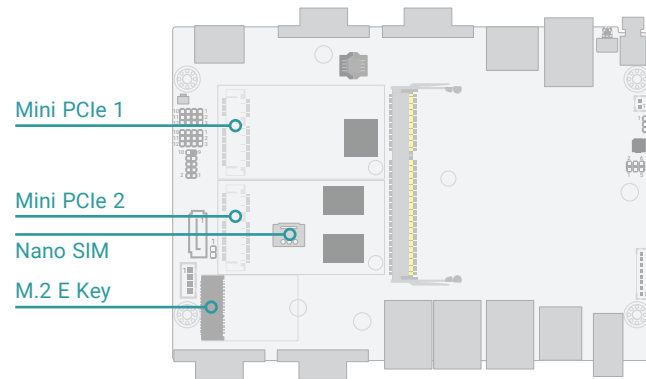

Mini PCIe

The Mini PCIe sockets allow for Mini PCIe modules that support multiple expansion modules.

Mini PCIe 1 supports full-size Mini PCIe modules for mSATA with SATA or USB 2.0 signals varies on the stock hardware settings.

Mini PCIe 2 supports full-size Mini PCIe modules for USB2.0, reset signals or nano-SIM. PCIe signals is also available in the config with 4 LANs installed.

Nano SIM

The Nano SIM socket allows the system to access a subscribed telecom service.

M.2 Socket

The M.2 socket is the Next Generation Form Factor (NGFF) which is designed to support multiple modules and make the M.2 more suitable in application for solid-state storage. The board preserves space and a standoff for the M.2 E key socket (22mm x 30mm).

Installing the Mini PCIe Module

Before installing the Mini PCIe module into the Mini PCIe socket, please make sure that the following safety cautions are well-attended.

1. Make sure the PC and all other peripheral devices connected to it has been powered down.
2. Disconnect all power cords and cables.
3. Locate the Mini PCIe socket on the system board
4. Make sure the notch on card is aligned to the key on the socket.

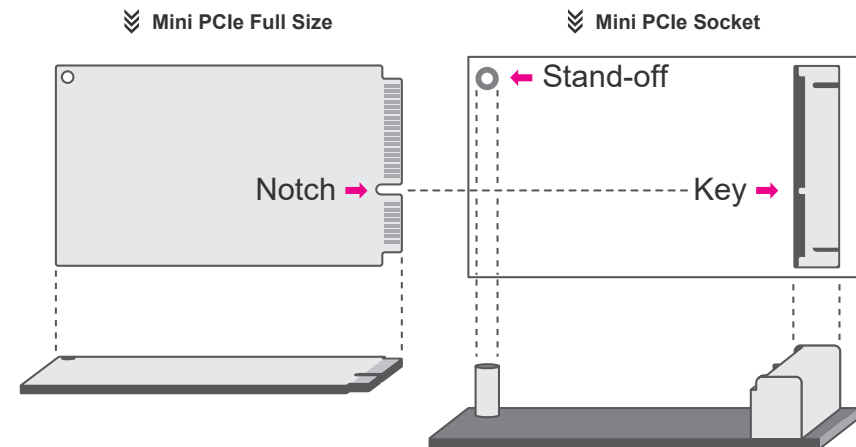

Please follow the steps below to install the card into the socket.

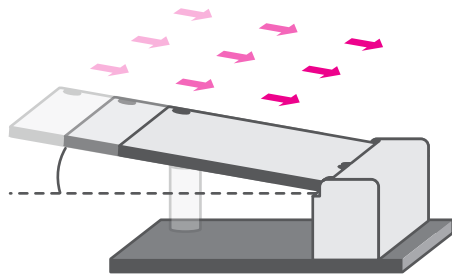

Step 1:
Insert the card into the socket at an angle while making sure the notch and key are perfectly aligned.

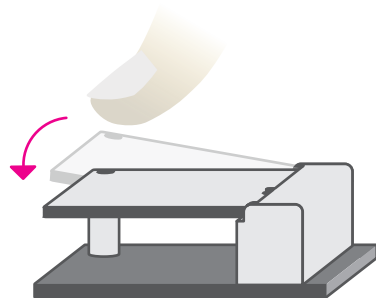

Step 2:
Press the end of the card far from the socket down until against the stand-off.

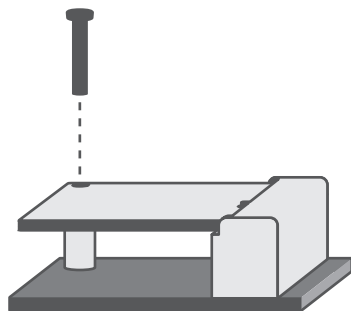

Step 3:
Screw tight the card onto the stand-off with a screw driver and a stand-off screw until the gap between the card and the stand-off closes up. The card should be lying parallel to the board when it's correctly mounted.

Installing SIM Card

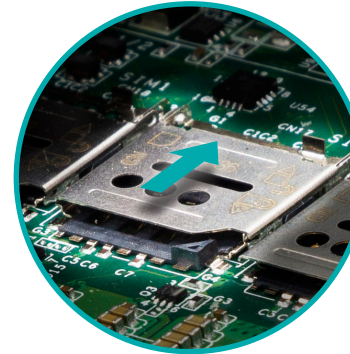

Step 1:
Slide the cover to unlock.



Step 2:
Lift the cover.

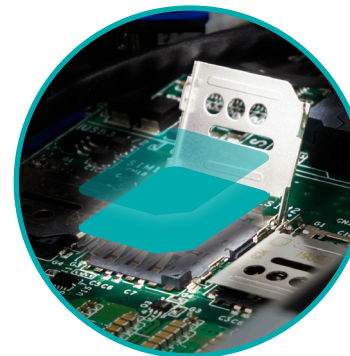

Step 3:
Orient the SIM card and place it into the socket.

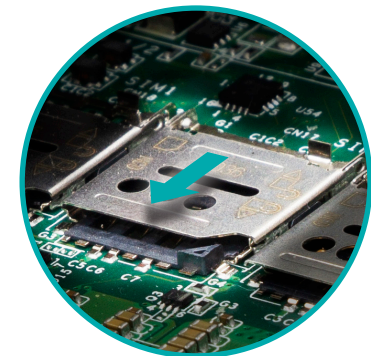

Step 4:
Close the cover and slide the cover to lock.

Chapter 3 - BIOS Settings

► Overview

The BIOS is a program that takes care of the basic level of communication between the CPU and peripherals. It contains codes for various advanced features found in this system board. The BIOS allows you to configure the system and save the configuration in a battery-backed CMOS so that the data retains even when the power is off. In general, the information stored in the CMOS RAM of the EEPROM will stay unchanged unless a configuration change has been made such as a hard drive replaced or a device added. It is possible that the CMOS battery will fail causing CMOS data loss. If this happens, you need to install a new CMOS battery and reconfigure the BIOS settings.



Note:

The BIOS is constantly updated to improve the performance of the system board; therefore the BIOS screens in this chapter may not appear the same as the actual one. These screens are for reference purpose only.

Default Configuration

Most of the configuration settings are either predefined according to the Load Optimal Defaults settings which are stored in the BIOS or are automatically detected and configured without requiring any actions. There are a few settings that you may need to change depending on your system configuration.

Entering the BIOS Setup Utility

The BIOS Setup Utility can only be operated from the keyboard and all commands are keyboard commands. The commands are available at the right side of each setup screen. The BIOS Setup Utility does not require an operating system to run. After you power up the system, the BIOS message appears on the screen and the memory count begins. After the memory test, the message "Press DEL to run setup" will appear on the screen. If the message disappears before you respond, restart the system or press the "Reset" button. You may also restart the system by pressing the <Ctrl> <Alt> and keys simultaneously.

Legends

Keys	Function
Right / Left arrow	Move the highlight left or right to select a menu
Up / Down arrow	Move the highlight up or down between submenus or fields
<Enter>	Enter the highlighted submenu
+ (plus key)/F6	Scroll forward through the values or options of the highlighted field
- (minus key)/F5	Scroll backward through the values or options of the highlighted field
<F1>	Display general help
<F2>	Display previous values
<F7>	Popup Boot Device List
<F9>	Optimized defaults
<F10>	Save and Exit
<Esc>	Return to previous menu

Scroll Bar

When a scroll bar appears to the right of the setup screen, it indicates that there are more available fields not shown on the screen. Use the up and down arrow keys to scroll through all the available fields.

Submenu

When "►" appears on the left of a particular field, it indicates that a submenu which contains additional options are available for that field. To display the submenu, move the highlight to that field and press <Enter>.

► Main

The Main menu is the first screen that you will see when you enter the BIOS Setup Utility.

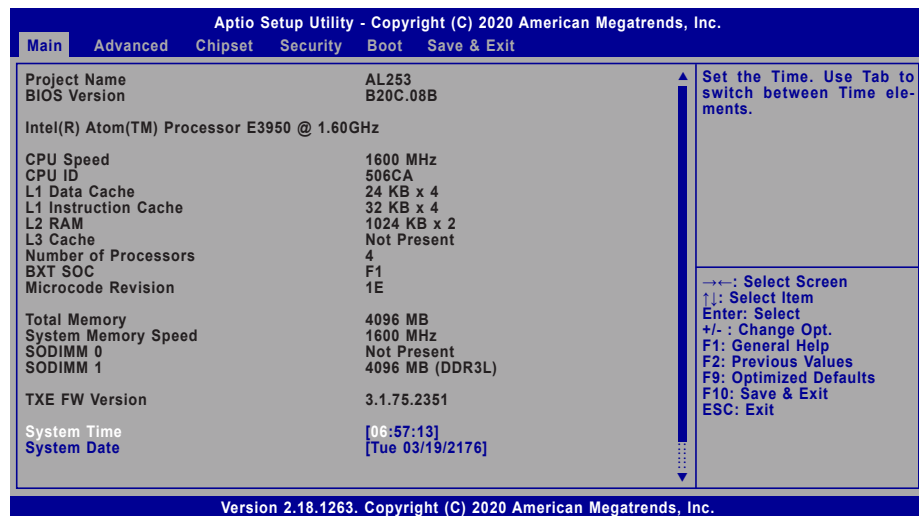

System Time

The time format is <hour>, <minute>, <second>. The time is based on the 24-hour military-time clock. For example, 1 p.m. is 13:00:00. Hour displays hours from 00 to 23. Minute displays minutes from 00 to 59. Second displays seconds from 00 to 59.

System Date

The date format is <month>, <date>, <year>. Press "Tab" to switch to the next field and press "-" or "+" to modify the value.

► Advanced

The Advanced menu allows you to configure your system for basic operation. Some entries are defaults required by the system board, while others, if enabled, will improve the performance of your system or let you set some features according to your preference.



Important:
Setting incorrect field values may cause the system to malfunction.

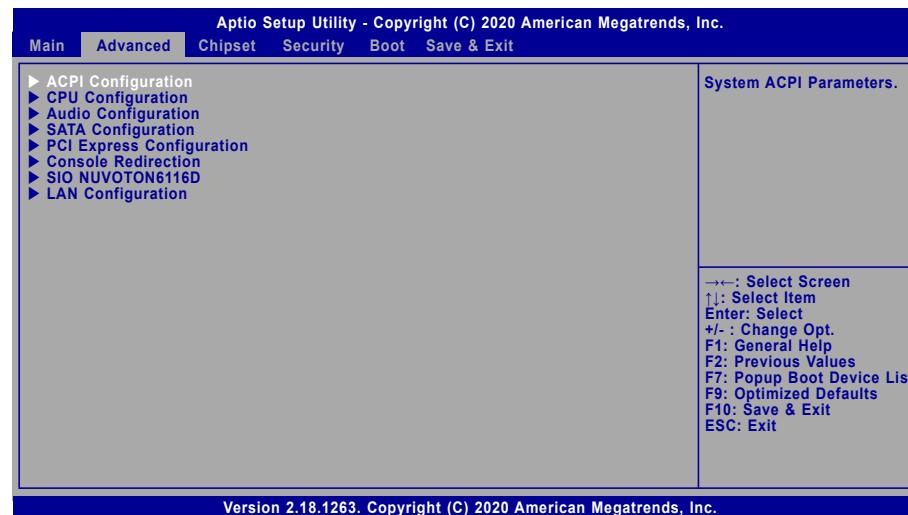

▶ Advanced

ACPI Configuration

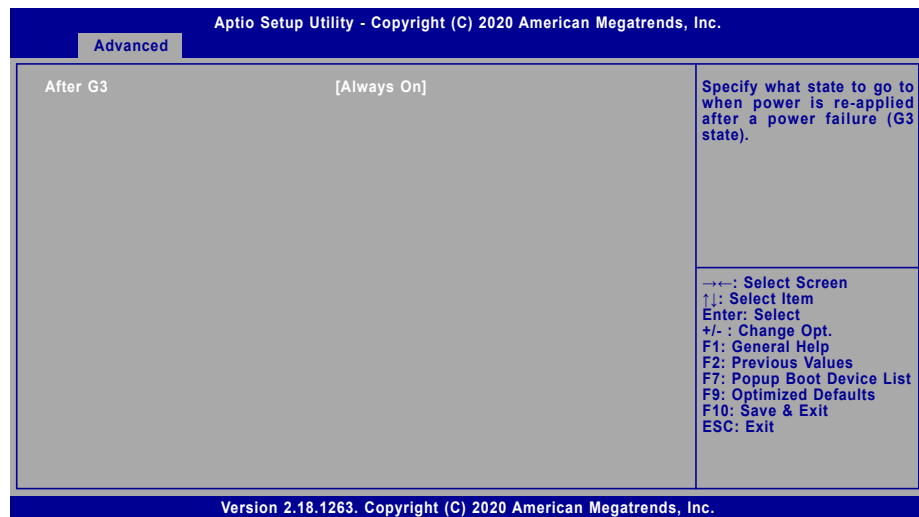

After G3

This field is to specify what state the system should be in when power is re-applied after a power failure.

- Always On** The system automatically powers on after power failure.
- Always Off** The system enter soft-off state after power failure. Power-on signal input is required to power up the system.

▶ Advanced

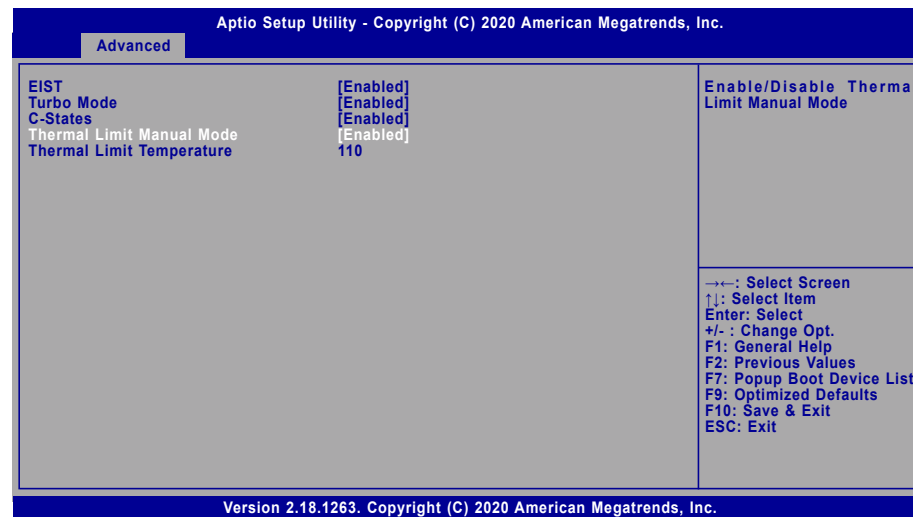

EIST

This field is used to enable or disable the Intel SpeedStep® Technology, which helps optimize the balance between system's power consumption and performance. After it is enabled in the BIOS, EIST features can then be enabled via the operating system's power management.

Turbo Mode

Enable or disable turbo mode of the processor. This field will only be displayed when EIST is enabled.

C-States

Enable or disable CPU Power Management. It allows CPU to enter "C states" when it's idle and nothing is executing.

Thermal Limit Manual Mode

Enable this field and manually set a temperature to which the CPU TDP adheres – increments from 80°C to 110°C.



Note: Some of the fields may not be available when the features are not supported by the equipped CPU.

▶ Advanced

Audio Configuration

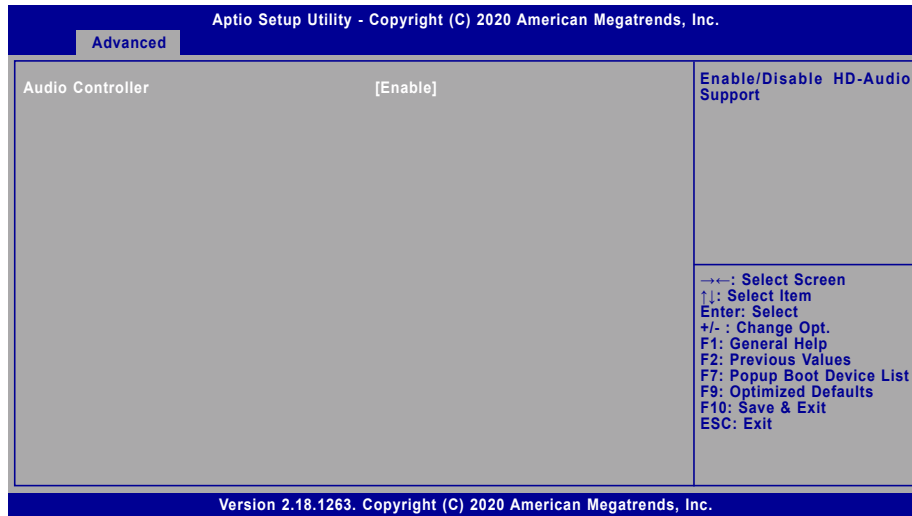

Audio Controller

Control the detection of the HD Audio device.

- Disable** HDA will be unconditionally disabled.
- Enable** HDA will be unconditionally enabled.

▶ Advanced

SATA Configuration

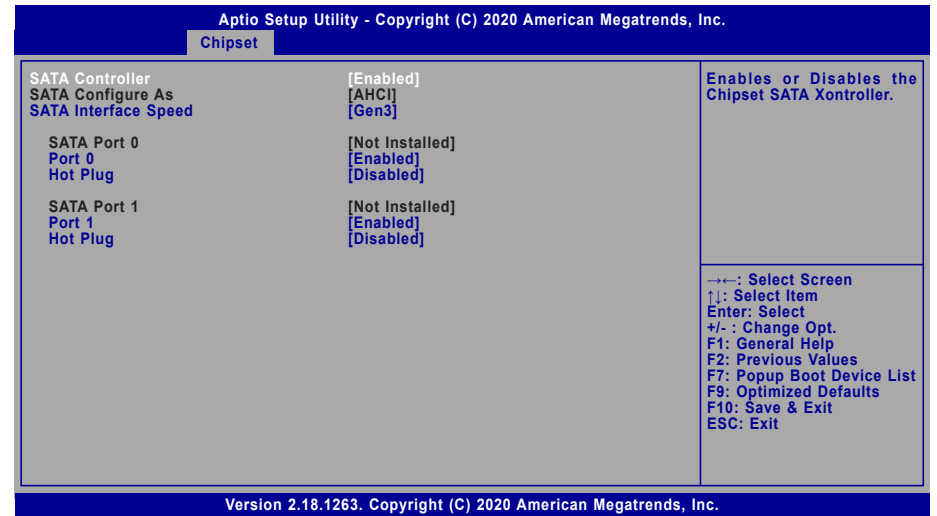

SATA Controller(s)

This field is used to enable or disable the Serial ATA controller.

SATA Speed

This field is used to select SATA speed generation limit: Gen1, Gen2 or Gen3.

SATA Port 0

Information about the mSATA (Mini PCIe 1) device.

SATA Port 1

Information about the SATA SSD Drive device.

Port 0/1 and Hot Plug

Enable or disable the Serial ATA port and its hot plug function.

► Advanced

PCI Express Configuration

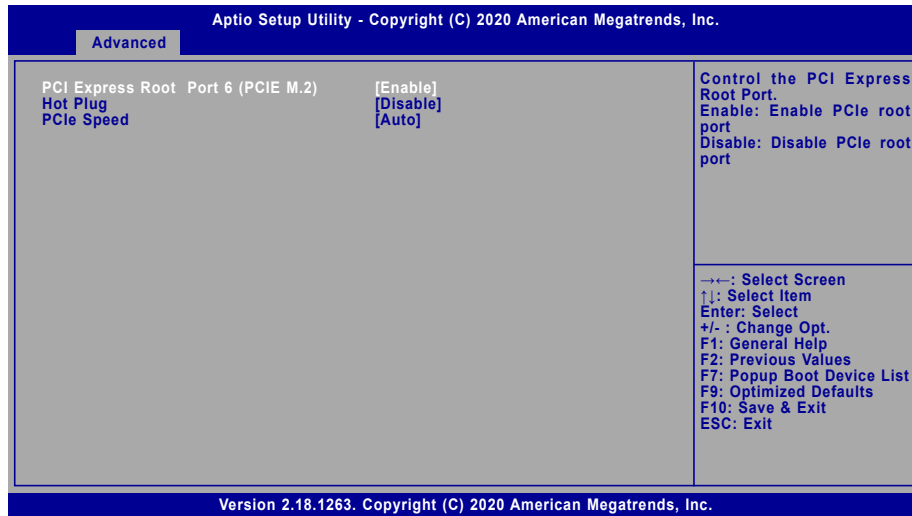

PCI Express Root Port 6 (PCIe M.2)

Enable or disable the PCI Express Root Port (M.2 E Key).

PCIe Speed

Select PCIe Speed of the current port – AUTO, Gen1, or Gen 2.

Hot Plug

Enable or disable hot plug function of the port.

► Advanced

Console Redirection

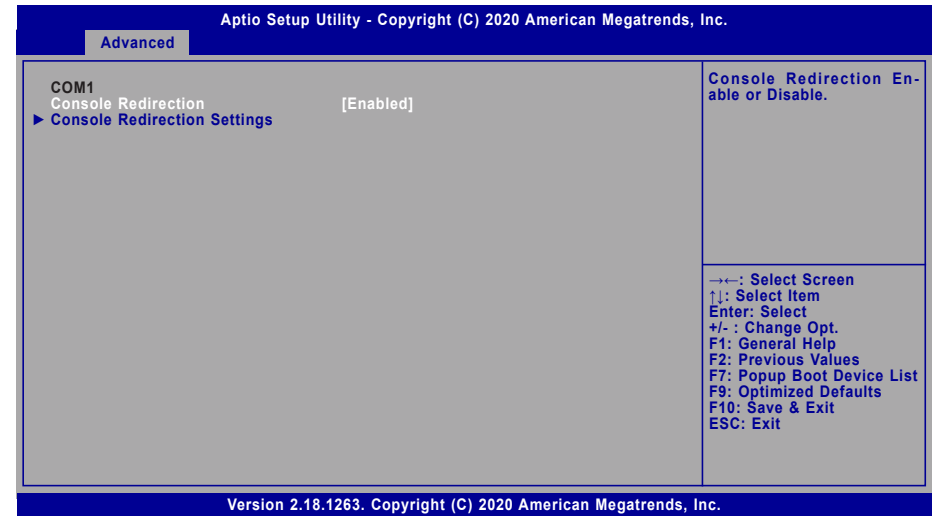

Console Redirection

By enabling Console Redirection of a COM port, the sub-menu of console redirection settings will become available for configuration as detailed in the following.

▶ **Advanced**

▶ **Console Redirection Settings**

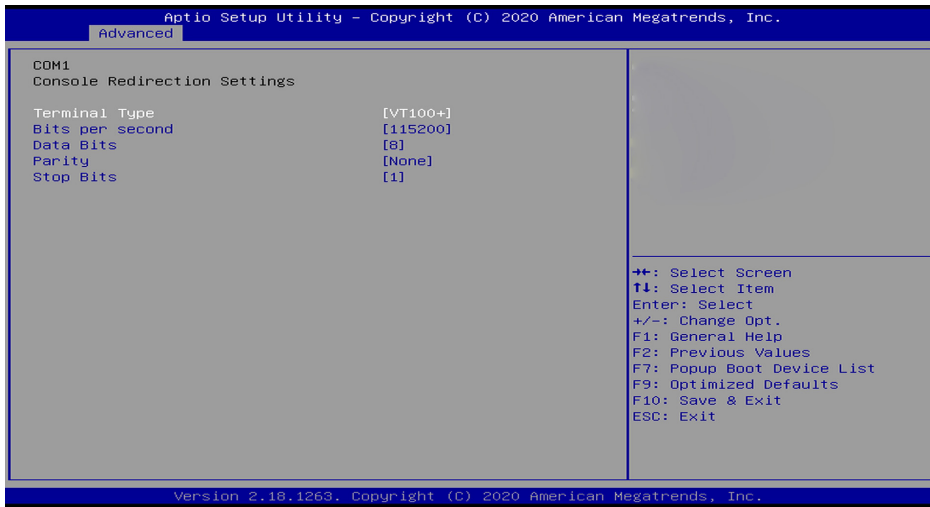

Configure the serial settings of the current COM port.

Terminal Type

Select terminal type: VT100, VT100+, VT-UTF8 or ANSI.

Bits per second

Select serial port transmission speed: 9600, 19200, 38400, 57600 or 115200.

Data Bits

Select data bits: 7 bits or 8 bits.

Parity

Select parity bits: None, Even, Odd, Mark or Space.

Stop Bits

Select stop bits: 1 bit or 2 bits.

▶ **Advanced**

SIO NUVOTON6116D

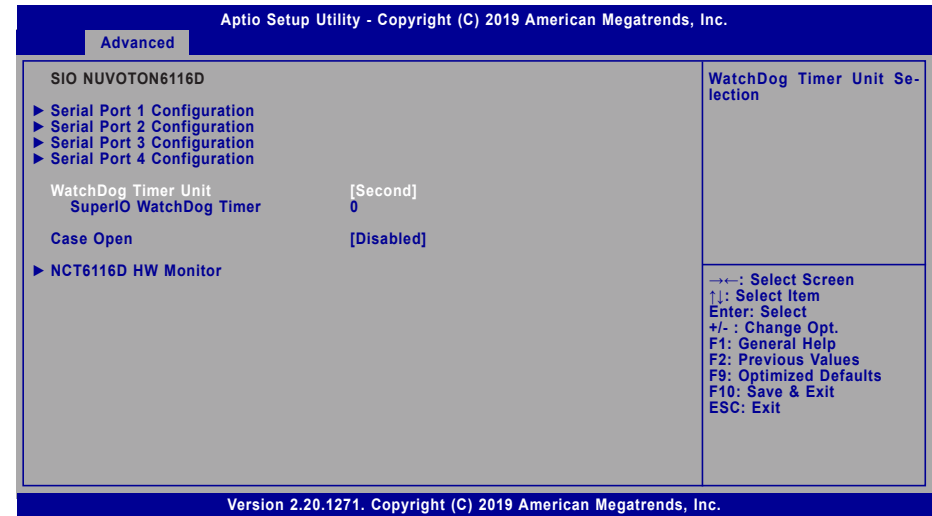

WatchDog Timer Unit

Select WatchDog Timer Unit — Second or Minute.

SuperIO WatchDog Timer

Set SuperIO WatchDog Timer Timeout value. The range is from 0 (disabled) to 255.

Case Open

Enable or disable the case open detection function.



Note:
The sub-menus are detailed in following sections.

▶ Advanced ▶ NCT6116D Super IO Configuration

▶ Serial Port 1/2/3/4 Configuration

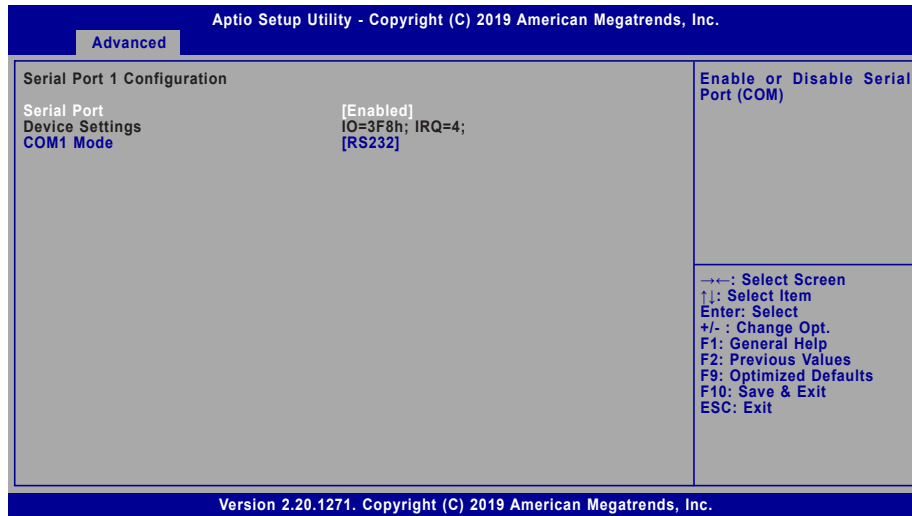

Serial Port

Enable or disable the current serial COM port.

COM1/2/3/4 Mode

Select the serial mode for the COM ports – RS232, RS422, or RS485.

▶ Advanced

NCT6116D HW Monitor

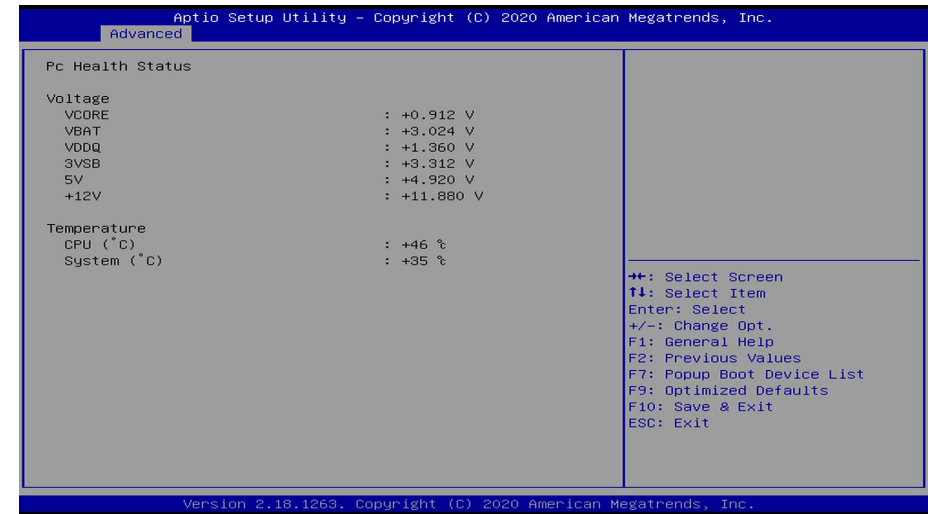

This section displays the system's health information, i.e. voltage readings, CPU and system temperature readings.

► **Advanced**

LAN Configuration

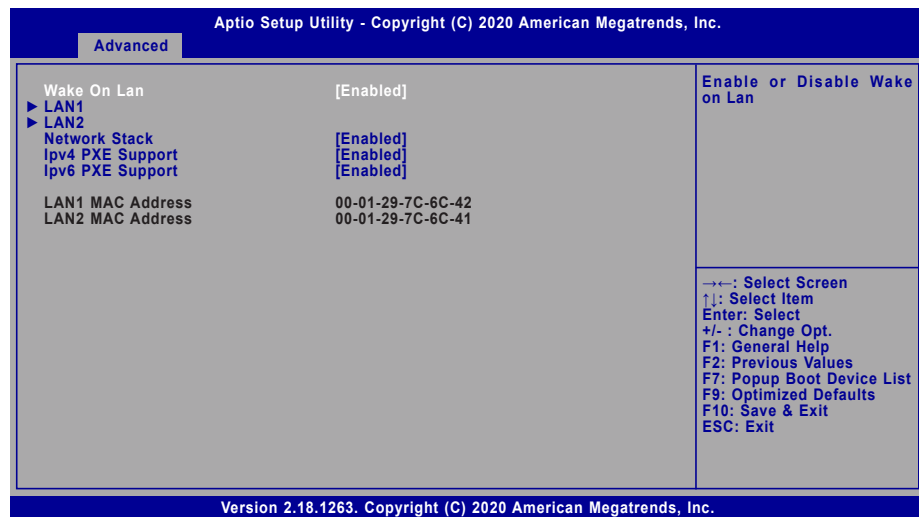

Wake On LAN

Enable or disable the function to wake the system via LAN.

► **LAN1/2**

Enable or disable a LAN port.

Network Stack

Enable or disable UEFI network stack. The following fields will appear when this field is enabled.

Ipv4 PXE Support

Enable or disable IPv4 PXE boot support.

Ipv6 PXE Support

Enable or disable IPv6 PXE boot support.



Note:
 The number of LAN ports can be 2 or 4 according to your system SKU.

► Security

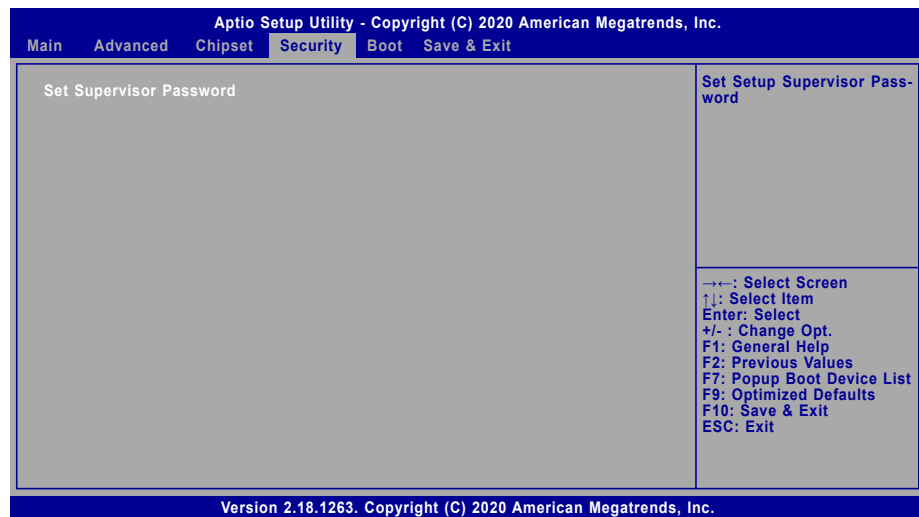

Set Supervisor Password

Set the supervisor password. To clear the password, input nothing and press enter when a new password is asked.

► Boot

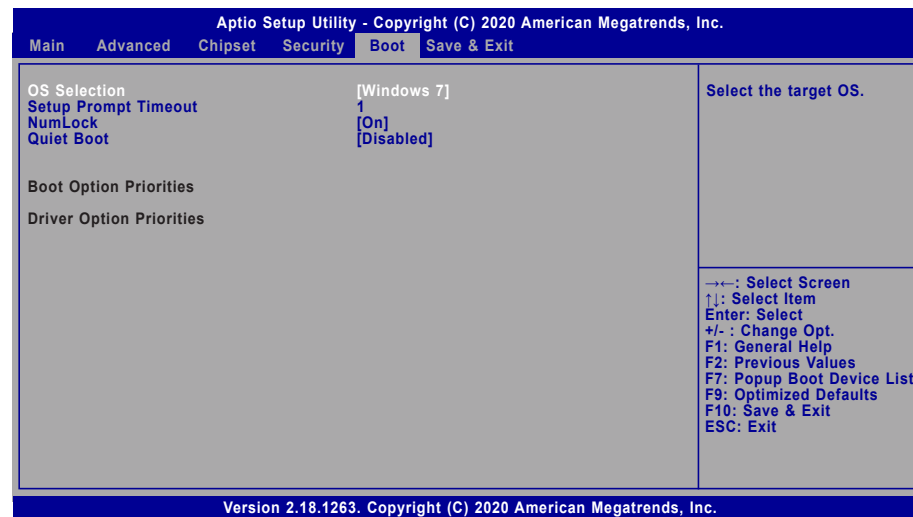

OS Selection

Select the target OS the system is to boot into – Windows 10, Windows 7, Linux.

Setup Prompt Timeout

Set the number of seconds to wait for the setup activation key – 1 to 65535, 65535 (0xFFFF) meaning indefinite waiting.

NumLock

Select the keyboard NumLock state – On or Off.

Quiet Boot

This section is used to enable or disable quiet boot option.

Boot Option Priorities

Rearrange the system boot order of available boot devices.

Driver Option Priorities

Select the driver boot order.

► Save & Exit

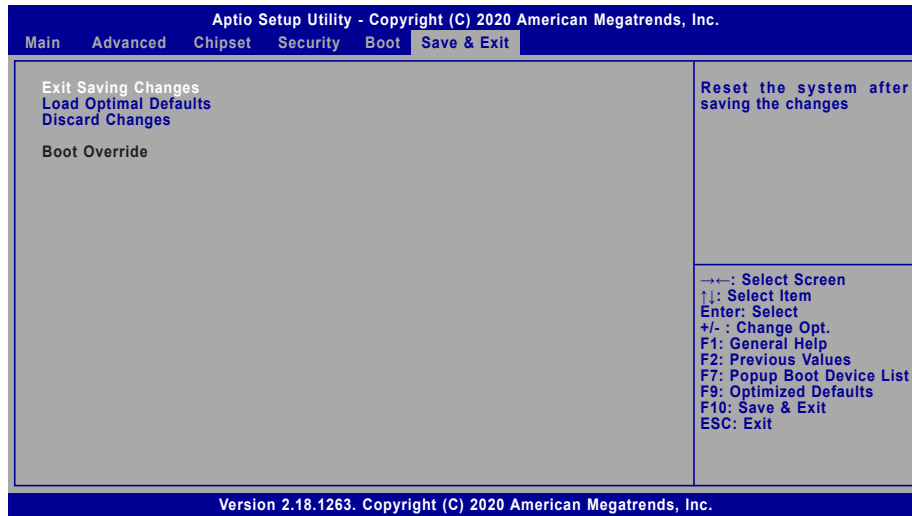

Exit Saving Changes

To save the changes, select this field and then press <Enter>. A dialog box will appear. Select Yes to reset the system after saving all changes made.

Load Optimal Defaults

To restore and load the optimized default values, select this field and then press <Enter>. A dialog box will appear. Select Yes to restore the default values of all the setup options.

Discard Changes

To discard the changes, select this field and then press <Enter>. A dialog box will appear. Select Yes to reset the system setup without saving any changes.

Boot Override

Move the cursor to an available boot device and press Enter, and then the system will immediately boot from the selected boot device. The Boot Override function will only be effective for the current boot. The “Boot Option Priorities” configured in the Boot menu will not be changed.

► Updating the BIOS

To update the BIOS, you will need the new BIOS file and a flash utility. Please contact technical support or your sales representative for the files and specific instructions about how to update BIOS with the flash utility. For updating AMI BIOS in UEFI mode, you may refer to the how-to video at <https://www.dfi.com/Knowledge/Video/5>.

► Notice: BIOS SPI ROM

1. The Intel® Management Engine has already been integrated into this system board. Due to the safety concerns, the BIOS (SPI ROM) chip cannot be removed from this system board and used on another system board of the same model.
2. The BIOS (SPI ROM) on this system board must be the original equipment from the factory and cannot be used to replace one which has been utilized on other system boards.
3. If you do not follow the methods above, the Intel® Management Engine will not be updated and will cease to be effective.



Note:

- a. You can take advantage of flash tools to update the default configuration of the BIOS (SPI ROM) to the latest version anytime.
- b. When the BIOS IC needs to be replaced, you have to populate it properly onto the system board after the EEPROM programmer has been burned and follow the technical person's instructions to confirm that the MAC address should be burned or not.