

## EHL556

3.5" SBC Industrial Motherboard  
User's Manual

---

## Copyright

This publication contains information that is protected by copyright. No part of it may be reproduced in any form or by any means or used to make any transformation/adaptation without the prior written permission from the copyright holders.

This publication is provided for informational purposes only. The manufacturer makes no representations or warranties with respect to the contents or use of this manual and specifically disclaims any express or implied warranties of merchantability or fitness for any particular purpose. The user will assume the entire risk of the use or the results of the use of this document. Further, the manufacturer reserves the right to revise this publication and make changes to its contents at any time, without obligation to notify any person or entity of such revisions or changes.

Changes after the publication's first release will be based on the product's revision. The website will always provide the most updated information.

© 2022. All Rights Reserved.

## Trademarks

Product names or trademarks appearing in this manual are for identification purpose only and are the properties of the respective owners.

## FCC and DOC Statement on Class B

This equipment has been tested and found to comply with the limits for a Class B digital device, pursuant to Part 15 of the FCC rules. These limits are designed to provide reasonable protection against harmful interference when the equipment is operated in a residential installation. This equipment generates, uses and can radiate radio frequency energy and, if not installed and used in accordance with the instruction manual, may cause harmful interference to radio communications. However, there is no guarantee that interference will not occur in a particular installation. If this equipment does cause harmful interference to radio or television reception, which can be determined by turning the equipment off and on, the user is encouraged to try to correct the interference by one or more of the following measures:

- Reorient or relocate the receiving antenna.
- Increase the separation between the equipment and the receiver.
- Connect the equipment into an outlet on a circuit different from that to which the receiver is connected.
- Consult the dealer or an experienced radio TV technician for help.

## Notice:

- The changes or modifications not expressly approved by the party responsible for compliance could void the user's authority to operate the equipment.
- Shielded interface cables must be used in order to comply with the emission limits.

# Table of Contents

Chapter 1 - Introduction.....	6
Specifications .....	6
Features .....	8
Block Diagram .....	9
Chapter 2 - Hardware Installation.....	10
Board Layout.....	10
System Memory .....	11
Installing the SODIMM Module.....	11
Removing the SODIMM Module.....	12
Panel Backlight Voltage (DPJP1).....	13
Panel Inverter Power Selection (DPJP2) .....	13
Panel Power .....	14
Rear I/O Ports.....	15
USB Ports .....	15
Graphics Interfaces .....	16
DC-In .....	17
Internal I/O Connectors .....	17
Audio .....	17
SATA (Serial ATA) .....	18
SATA Power .....	18
COM (Serial) ports.....	19
Cooling Fan Connectors.....	20
Front Panel.....	21
USB 2.0.....	21
Expansion Slots .....	22
Installing the M.2 Module .....	22
Battery Header.....	23
LVDS Backlight.....	24
eDP .....	25
Chapter 3 - BIOS Settings.....	26
Overview .....	26
Main.....	27
Advanced .....	27
RC ACPI Configuration.....	28
CPU Configuration .....	28
Power & Performance.....	29
PCH-FW Configuration .....	29
Trusted Computing.....	30
PTN3460 Configuration .....	30
NCT5525D Super IO Configuration .....	31
NCT5525D HW Monitor .....	32
Serial Port Console Redirection .....	33
USB Configuration .....	34
Network Stack Configuration.....	35
USB Power Control.....	35
Chipset .....	36
Memory Configuration .....	36
Graphics Configuration .....	37
PCH-IO Configuration .....	38
PCI Express Configuration .....	38
SATA And RST Configuration .....	39
HD Audio Configuration .....	39
Security .....	40

Secure Boot.....	40
Boot .....	42
Save & Exit .....	42
Updating the BIOS.....	43
Notice: BIOS SPI ROM.....	43

## About this Manual

This manual can be downloaded from the website.

The manual is subject to change and update without notice, and may be based on editions that do not resemble your actual products. Please visit our website or contact our sales representatives for the latest editions.

## Warranty

- Warranty does not cover damages or failures that occur from misuse of the product, inability to use the product, unauthorized replacement or alteration of components and product specifications.
- The warranty is void if the product has been subjected to physical abuse, improper installation, modification, accidents or unauthorized repair of the product.
- Unless otherwise instructed in this user's manual, the user may not, under any circumstances, attempt to perform service, adjustments or repairs on the product, whether in or out of warranty. It must be returned to the purchase point, factory or authorized service agency for all such work.
- We will not be liable for any indirect, special, incidental or consequential damages to the product that has been modified or altered.

## Static Electricity Precautions

It is quite easy to inadvertently damage your PC, system board, components or devices even before installing them in your system unit. Static electrical discharge can damage computer components without causing any signs of physical damage. You must take extra care in handling them to ensure against electrostatic build-up.

- To prevent electrostatic build-up, leave the system board in its anti-static bag until you are ready to install it.
- Wear an antistatic wrist strap.
- Do all preparation work on a static-free surface.
- Hold the device only by its edges. Be careful not to touch any of the components, contacts or connections.
- Avoid touching the pins or contacts on all modules and connectors. Hold modules or connectors by their ends.



**Important:**

Electrostatic discharge (ESD) can damage your processor, disk drive and other components. Perform the upgrade instruction procedures described at an ESD workstation only. If such a station is not available, you can provide some ESD protection by wearing an antistatic wrist strap and attaching it to a metal part of the system chassis. If a wrist strap is unavailable, establish and maintain contact with the system chassis throughout any procedures requiring ESD protection.

## Safety Measures

- To avoid damage to the system, use the correct AC input voltage range.
- To reduce the risk of electric shock, unplug the power cord before removing the system chassis cover for installation or servicing. After installation or servicing, cover the system chassis before plugging the power cord.

## About the Package

The package contains the following items. If any of these items are missing or damaged, please contact your dealer or sales representative for assistance.

- 1 EHL556 motherboard

The board and accessories in the package may not come similar to the information listed above. This may differ in accordance with the sales region or models in which it was sold. For more information about the standard package in your region, please contact your dealer or sales representative.

## Optional Items

The board and accessories in the package may not come similar to the information listed above. This may differ in accordance with the sales region or models in which it was sold. For more information about the standard package in your region, please contact your dealer or sales representative.

Items	Part Number	Description
Power adapter	671-106012-000G	60W, 12V, DC Jack, 0~40°C
	671-106013-000G	60W, 12V, DC Jack, -30 to 70°C
USB 2.0 cable	A81-001032-016G	Length: 200mm
Heat spreader	A71-808363-010G	HEATSPREADER, AL1050 146*102*7.5mm, FOR EHL556 BAREDIE CPU (J6413, J6412, J646, N621, N6210, N6415)
	A71-808363-000G	HEATSPREADER, AL1050 146*102*7.5mm, FOR EHL556 IHS CPU (x6211E, x6413E, x6425E, x6414RE, x6425RE)

## Before Using the System Board

When installing the system board in a new system, you will need at least the following internal components.

- Memory module
- Storage device such as a hard disk drive.
- Power supply

External system peripherals may also be required for navigation and display, including at least a keyboard, a mouse and a video display monitor.

## Chapter 1 - Introduction

### ► Specifications

SYSTEM	Processor	Intel Atom Elkhart Lake <b>Industrial</b> Atom, x6425RE, 4C, 1.9GHz,12W Atom, x6414RE, 4C, 1.5GHz,9W <b>Embedded</b> Atom, x6425E, 4C, 2.0GHz(3.0GHz),12W Atom, x6413E, 4C, 1.5GHz(3.0GHz),9W <b>PC Client</b> Celeron N6210, 2C 1.2GHz(2.6GHz), 6.5W	
	Memory	Single DDR4-3200 SODIMM Up to 32GB	
	BIOS	AMI SPI 256Mbit	
	GRAPHICS	Controller	Intel® HD Graphics
GRAPHICS	Feature	OpenGL 5.0, DirectX 12, OpenCL 2.1 HW Decode: AVC/H.264, MPEG2, VC1, WMV9, JPEG/MJPEG, HEVC/H.265, VP8, VP9, MVC HW Encode: AVC/H.264, JPEG/MJPEG, HEVC/H.265, VP8, VP9, MVC	
	Display	1 x VGA (or BOM option change to HDMI 2.0)	HDMI: resolution up to 1920x1080 @60Hz
		1 x DP++	DP++: resolution up to 4096x2304 @60Hz
		1 x LVDS or eDP + Backlight	LVDS: resolution up to 1920x1200 @60Hz
Triple Display	VGA + DP++ + LVDS/eDP		
EXPANSION	Interface	1 x M.2 2230 E key (USB/PCIe) (Support WiFi 5 & WiFi 6) 1 x mini-PCIe (USB/PCIe) I2C	
AUDIO	Audio Codec	Realtek ALC888	
ETHERNET	Controller	2 x Intel® I225-IT PCIe	
REAR I/O	Ethernet	2 x GbE (RJ-45)	
	USB	2 x USB 3.1 Gen2 10Gbps	
	Display	1 x DP++ 1 x VGA	
INTERNAL I/O	Serial	1 x RS232/422/485 + 1 x RS232, or 1 x RS232/422/485 + 8bit DIO (BIOS select)	
	USB	4 x USB 2.0	
	Display	1 x LVDS or eDP + Backlight	
	Audio	1 x Audio (Line-out/Mic-in)	
	SATA	1 x SATA 3.0 1 x 5V SATA Power (support SATA HDD LED via front panel)	
	Front Panel	1 x front panel (power button/reset button, power LED, HDD act LED)	

<b>WATCHDOG TIMER</b>	<b>Output &amp; Interval</b>	System Reset, Programmable via Software from 1 to 255 Seconds	
<b>SECURITY</b>	<b>TPM</b>	TPM 2.0	
<b>POWER</b>	<b>Type</b>	Wide Range 9~36VDC	
	<b>Connector</b>	DC Jack (or vertical type 4pin connector)	
	<b>Consumption</b>	TBD	
	<b>RTC Battery</b>	CR2032 Coin Cell	
<b>OS SUPPORT</b>	<b>Microsoft</b>	Windows 10 IoT 2019 LTSC Windows 10 IoT 2021 LTSC Linux	
	<b>Linux</b>	Linux	
<b>ENVIRONMENT</b>	<b>Temperature</b>	Operating: -40°C ~ 85°C	Storage: -40°C ~ 85°C
	<b>Humidity</b>	Operating: 5% ~ 90% RH	Storage: 5% ~ 90% RH
	<b>MTBF</b>	TBD	
<b>MECHANISM</b>	<b>Dimensions</b>	3.5" SBC Form Factor	146mm (5.75") x 102mm (4.02")
<b>STANDARDS AND CERTIFICATIONS</b>	<b>Certifications</b>	CE, FCC Class B (TBD in later stage), RoHS, UKCA	

## ► Features

### Watchdog Timer

The Watchdog Timer function allows your application to regularly “clear” the system at the set time interval. If the system hangs or fails to function, it will reset at the set time interval so that your system will continue to operate.

### DDR4

DDR4 delivers increased system bandwidth and improves performance. The advantages of DDR4 provide an extended battery life and improve the performance at a lower power than DDR3/DDR2.

### Serial ATA

Serial ATA is a storage interface that is compliant with SATA 1.0a specification. With speed of up to 6Gb/s (SATA 3.0), it improves hard drive performance faster than the standard parallel ATA whose data transfer rate is 100MB/s.

### Gigabit LAN

Two Intel® Ethernet Controller I225 support up to 2.5GbE data transmission.

### Wake-On-LAN

This feature allows the network to remotely wake up a Soft Power Down (Soft-Off) PC. It is supported via the onboard LAN port or via a PCI LAN card that uses the PCI PME (Power Management Event) signal. However, if your system is in the Suspend mode, you can power-on the system only through an IRQ or DMA interrupt.

### Wake-On-USB

This function allows you to use a USB keyboard or USB mouse to wake up a system from the S3 (STR - Suspend To RAM) state.

### PCI Express

PCI Express is a high bandwidth I/O infrastructure that possesses the ability to scale speeds by forming multiple lanes. The x4 PCI Express lane supports transfer rate of 4 Gigabyte per second (2 directions). The PCI Express architecture also supports high performance graphics infrastructure by enhancing the capability of a PCIe x16 Gen 3 at 16GB/s bandwidth (8GB/s in each direction).

### ACPI STR

The system board is designed to meet the ACPI (Advanced Configuration and Power Interface) specification. ACPI has energy saving features that enables PCs to implement Power Management and Plug-and-Play with operating systems that support OS Direct Power Management. ACPI when enabled in the Power Management Setup will allow you to use the Suspend to RAM function.

With the Suspend to RAM function enabled, you can power-off the system at once by pressing the power button or selecting “Standby” when you shut down Windows® without having to go through the sometimes tiresome process of closing files, applications and operating system. This is because the system is capable of storing all programs and data files during the entire operating session into RAM (Random Access Memory) when it powers-off. The operating session will resume exactly where you left off the next time you power-on the system.

### Power Failure Recovery

When power returns after an AC power failure, you may choose to either power-on the system manually or let the system power-on automatically.

### USB

The system board supports the new USB 3.1 Gen 2. It is capable of running at a maximum transmission speed of up to 10 Gbit/s (1250 MB/s), and is faster than USB 2.0 (480 Mbit/s, or 60 MB/s) and USB 1.1 (12Mb/s). USB 3.1 reduces the time required for data transmission, reduces power consumption, and is backward compatible with USB 2.0. It is a marked improvement in device transfer speeds between your computer and a wide range of simultaneously accessible external Plug and Play peripherals.

### RTC Timer

The Real Time Clock (RTC) installed on the system board allows your system to automatically power-on on the set date and time.



► Block Diagram

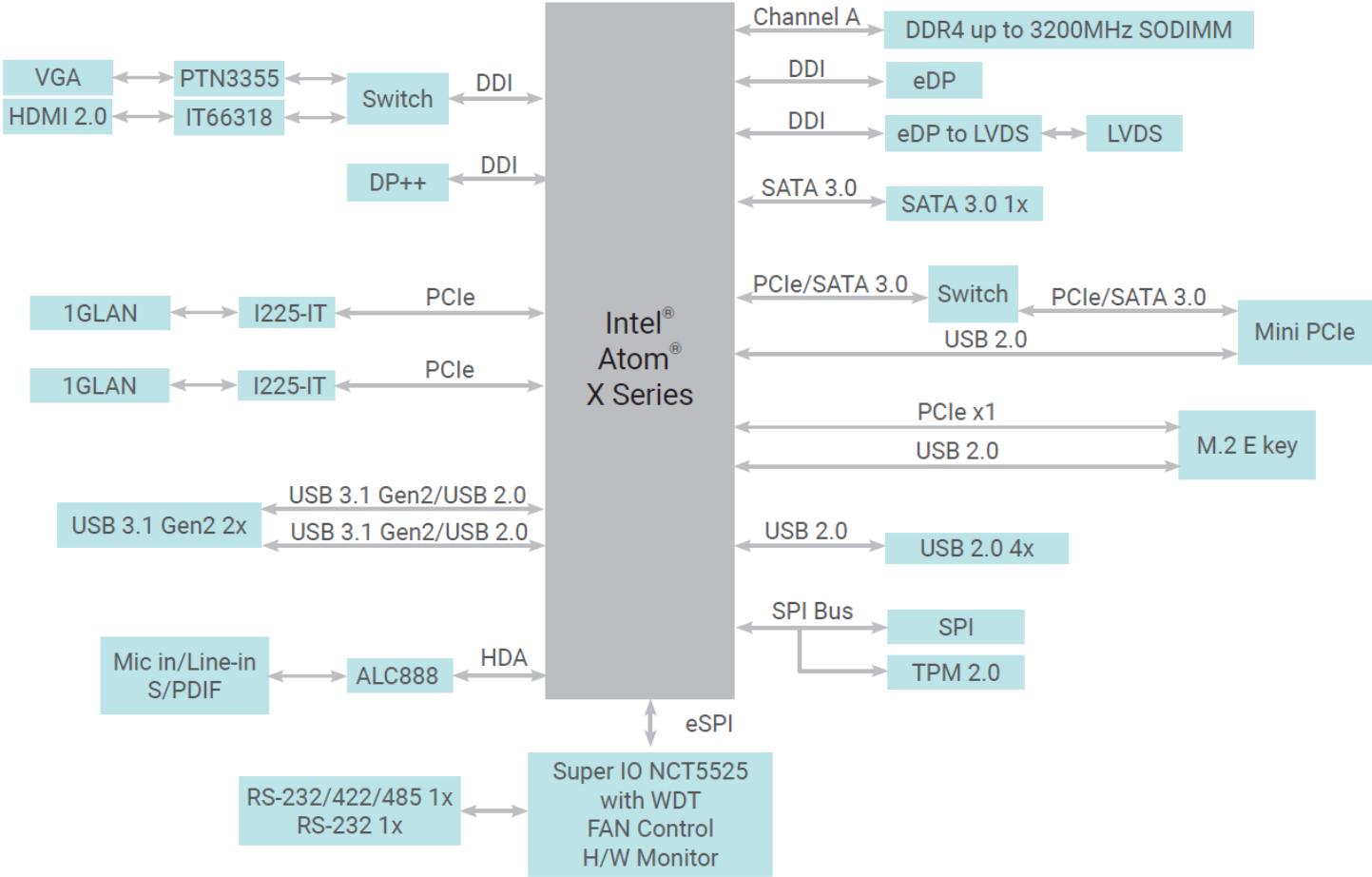

# Chapter 2 - Hardware Installation

## ► Board Layout

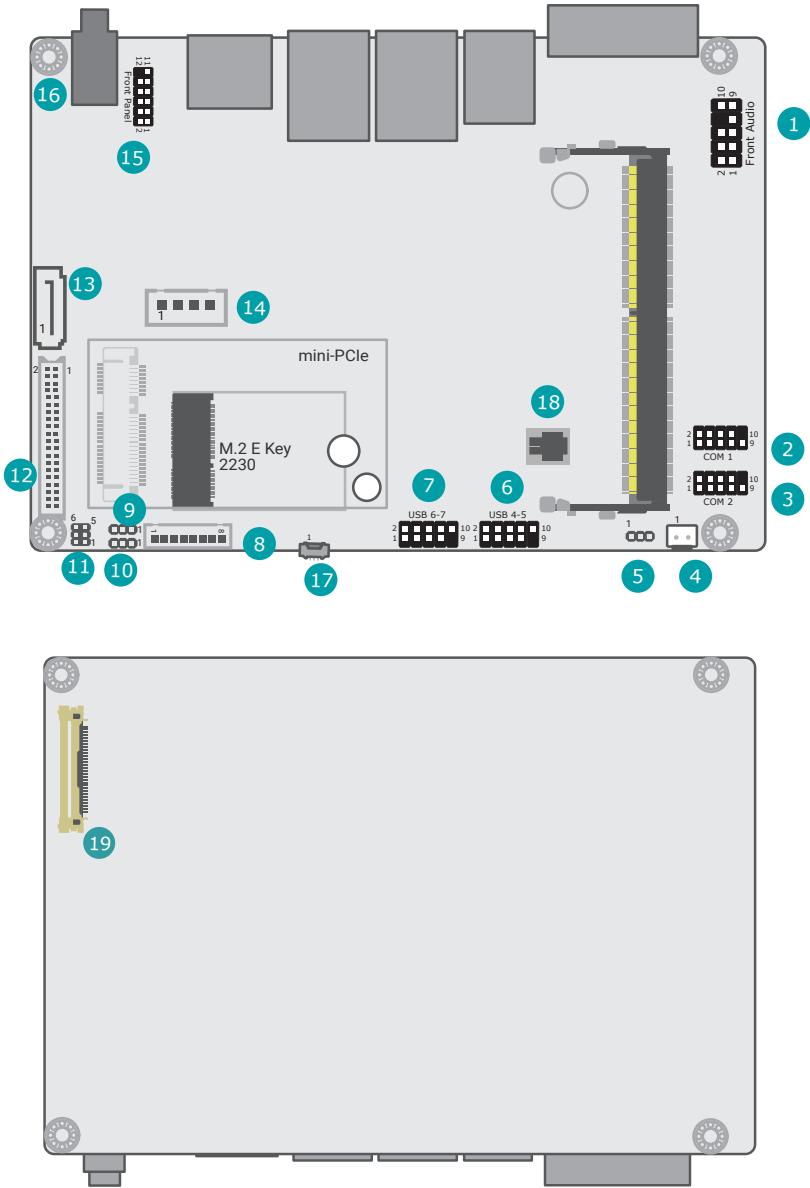

**Note:** Some components are optional and only available upon request.

**Important:** Electrostatic discharge (ESD) can damage your board, processor, disk drives, add-in boards, and other components. Perform installation procedures at an ESD workstation only. If such a station is not available, you can provide some ESD protection by wearing an antistatic wrist strap and attaching it to a metal part of the system chassis. If a wrist strap is unavailable, establish and maintain contact with the system chassis throughout any procedures requiring ESD protection.

- 1 Front Audio
- 2 COM 1
- 3 COM 2 or 8bit GPIO
- 4 Battery
- 5 UART
- 6 USB2\_4/5
- 7 USB2\_6/7
- 8 Backlight Control
- 9 Panel Backlight
- 10 Panel Inverter Power
- 11 Panel Power
- 12 LVDS
- 13 SATA1
- 14 SATA Power
- 15 Front Panel
- 16 9~36VDC-In 2x2 Pin DC Input (Opt.)
- 17 System Fan
- 18 eSPI
- 19 eDP

► **System Memory**

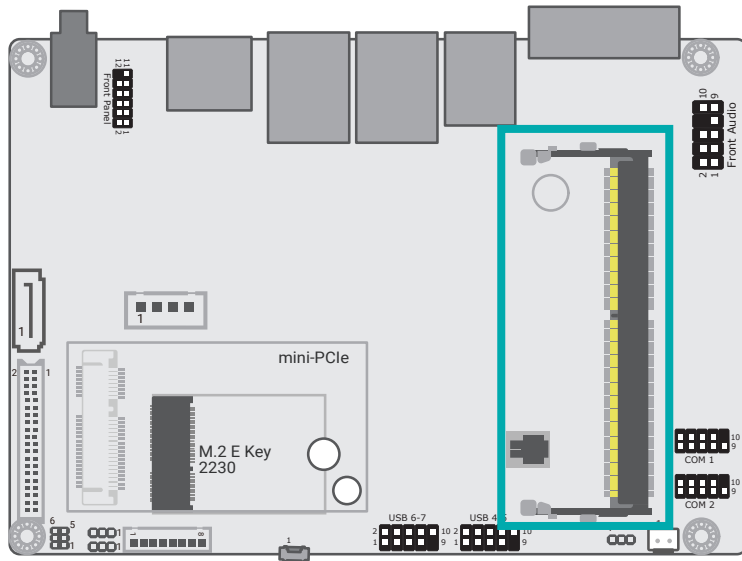

The system board supports the following memory interface.

**Single Channel (SC)**

Data will be accessed in chunks of 64 bits from the memory channels. DIMMs are on the same channel. DIMMs in a channel can be identical or completely different. However, we highly recommend using identical DIMMs. Not all slots need to be populated.

**Features**

- 1 x 260-pin SODIMM up to 32GB
- Single channel DDR4 up to 3200MHz (in-band ECC support in embedded/industrial SKU)

► **System Memory**

**Installing the SODIMM Module**

Before installing the memory module, please make sure that the following safety cautions are well-attended.

- Make sure the PC and all other peripheral devices connected to it has been powered down.
- Disconnect all power cords and cables.
- Locate the SODIMM socket on the system board
- Make sure the notch on memory card is aligned to the key on the socket.

► System Memory ► Installing the SODIMM Module

Please follow the steps below to install the memory card into the socket.

**Step 1:**  
Grasping the module by its edges, align the module into the socket at an approximately 30 degrees angle. Apply firm even pressure to each end of the module until it slips down into the socket. The contact fingers on the edge of the module will almost completely disappear inside the socket.

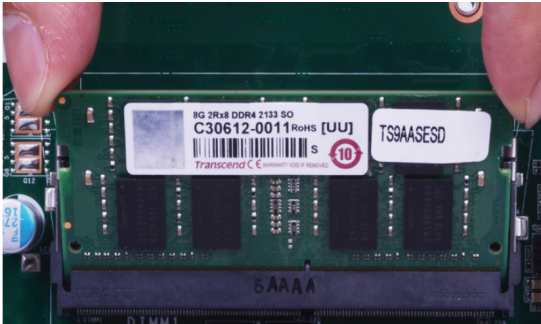

**Step 2:**  
Push down the module until the clips at each end of the socket lock into position. You will hear a distinctive “click”, indicating the module is correctly locked into position.



► System Memory

Removing the SODIMM Module

Please follow the steps below to remove the memory card from the socket.

**Step 1:**  
Press the eject tabs at both ends of the socket outward and downward to release them from the locked position.

**Step 2:**  
The memory card ejects from the slot automatically.

**Step 3:**  
Hold the card by its edges and remove it from the slot.



► **Jumper Settings**

**Panel Backlight Voltage (DPJP1)**

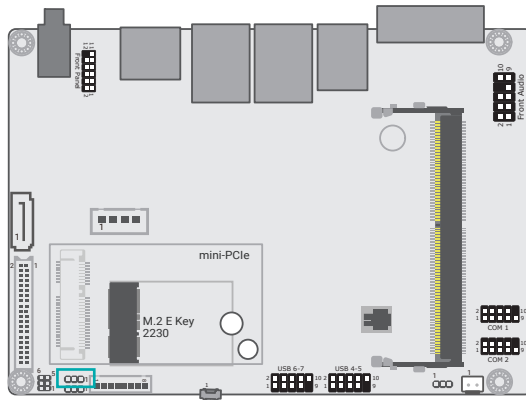

This jumper is to determine the power of panel backlight.

<b>Panel Backlight Voltage</b>	<b>DPJP1</b>
3.3V(default)	1-2 On
5V	2-3 On

**Panel Inverter Power Selection (DPJP2)**

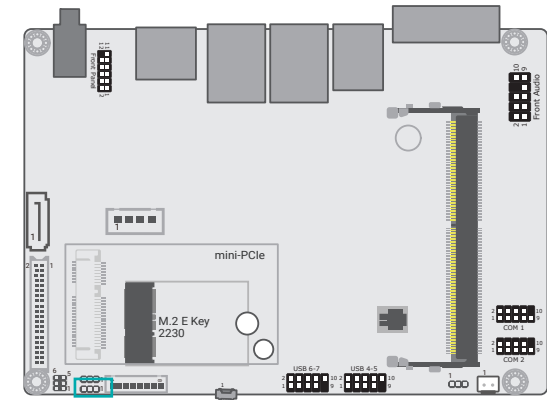

This jumper is to determine the power of panel inverter.

<b>Panel Inverter Power Selection</b>	<b>DPJP2</b>
12V(default)	1-2 On
5V	2-3 On

► Jumper Settings

Panel Power

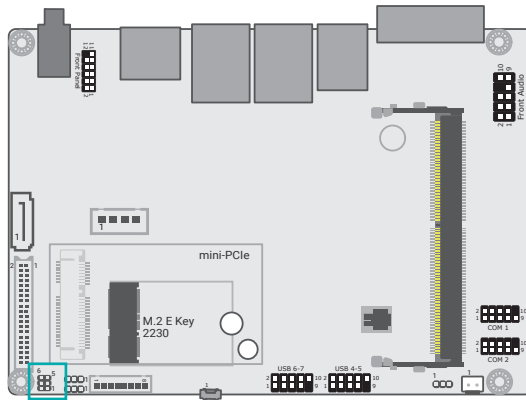

This jumper is to determine the dimming of panel backlight.

Panel Power Jumper	DPJP3
12V	1-2 On
5V	3-4 On
3.3V(default)	5-6 On

► **Rear I/O Ports**

USB Ports

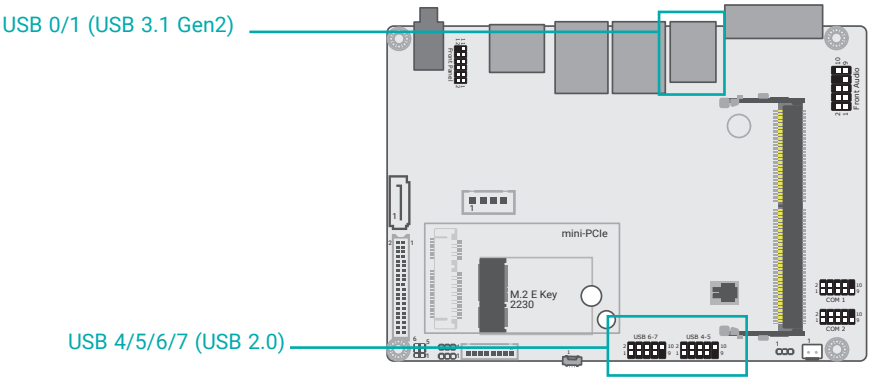

■ USB 2.0 Headers (USB 4/5/6/7) : Pitch 2.0mm

Pin	Function	Pin	Function
1	5V_USB45(67)	2	5V_USB45(67)
3	USB2_4(6)_C_N	4	USB2_5(7)_C_N
5	USB2_4(6)_C_P	6	USB2_5(7)_C_P
7	GND	8	GND
9	---	10	N.C.

The USB device allows data exchange between your computer and a wide range of simultaneously accessible external Plug and Play peripherals. The system board is equipped with multiple USB ports as listed below:

- 2 x USB 3.1 Gen 2 rear ports (USB 0/1)
- 4 x USB 2.0 internal ports, box headers (USB 4/5/6/7)

The internal USB ports may be mounted on a card-edge bracket. Install the card-edge bracket to an available slot at the rear of the system chassis and then insert the USB port cables to a connector.

**Wake-On-USB Keyboard/Mouse**

The Wake-On-USB Keyboard/Mouse function allows you to use a USB keyboard or USB mouse to wake up a system from the S3 (STR - Suspend To RAM) state.

► **Rear I/O Ports**

**Graphics Interfaces**

The display ports consist of the following:

- 1 DP++ Port
- 1 VGA port

**DP++ Port**

The DP++ port which carries both digital audio and video signals is used to connect a LCD monitor or a digital TV that has the DP++ port.

**VGA Port**

The VGA port which carries video signals is used to connect a LCD monitor that has the VGA port.

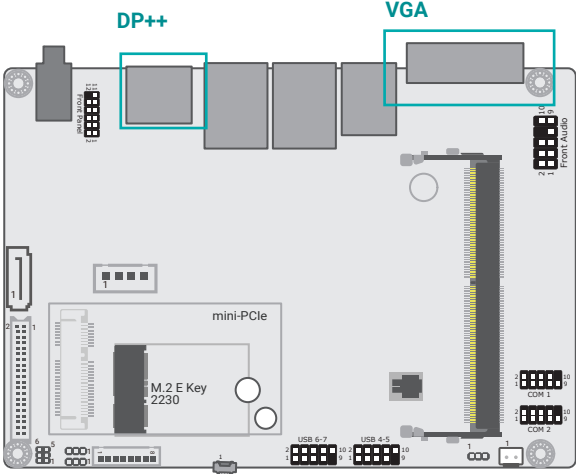



► Rear I/O Ports

DC-In

9~36VDC-In or 2x2 pin DC input (Opt.)

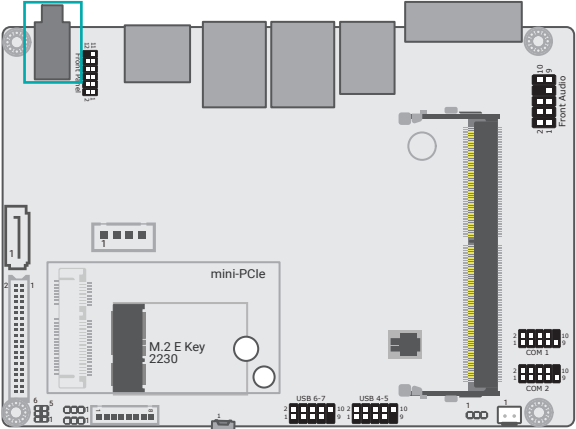

Pin	Function
1	GND-1
2	GND-2
3	12V-1
4	12V-2

2x2 Pin DC Input (Opt.) :



9~36VDC-In :



► Internal I/O Connectors

Audio

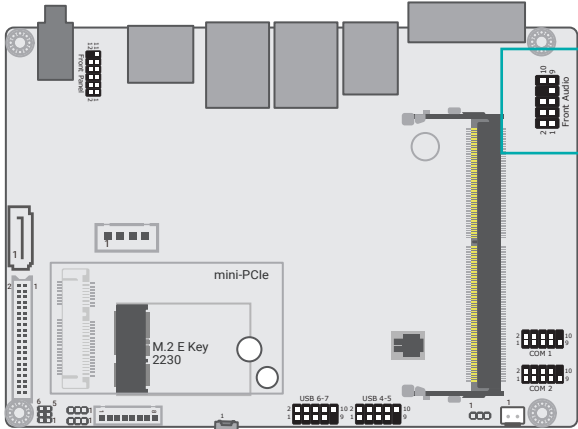

Front Audio

The front audio connector allows you to connect to the second line-out and mic-in jacks that are at the front panel of your system.

Pin	Function	Pin	Function
1	MIC2-L	2	AGND_AUDIO
3	MIC2-R	4	N.C.
5	LINE2-R	6	MIC2-JD
7	AGND_AUDIO	8	--
9	LINE2-L	10	LINE2-JD

► Internal I/O Connectors

SATA (Serial ATA)

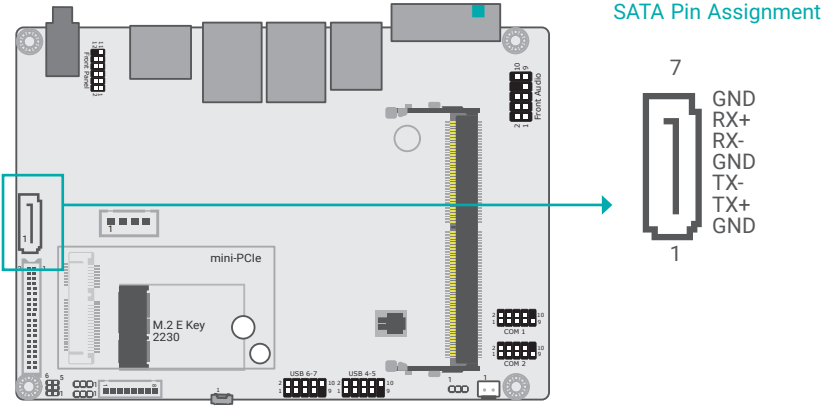

SATA Power

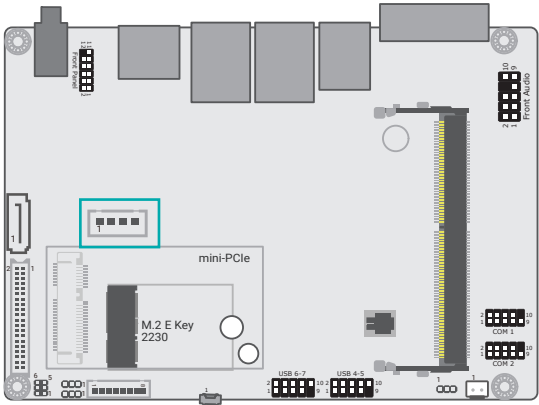

The Serial ATA (SATA) connectors are used to connect the Serial ATA device. SATA 3.0 is supported by the 2 SATA ports and provides data rate up to 6Gb/s. Connect one end of the Serial ATA cable to a SATA connector and the other end to your Serial ATA device.

The SATA power provides power to the SATA HDD.

Features

- 1 Serial ATA 3.0 ports with data transfer rate up to 6Gb/s
- Integrated Advanced Host Controller Interface (AHCI) controller

Internal I/O Connectors

COM (Serial) ports

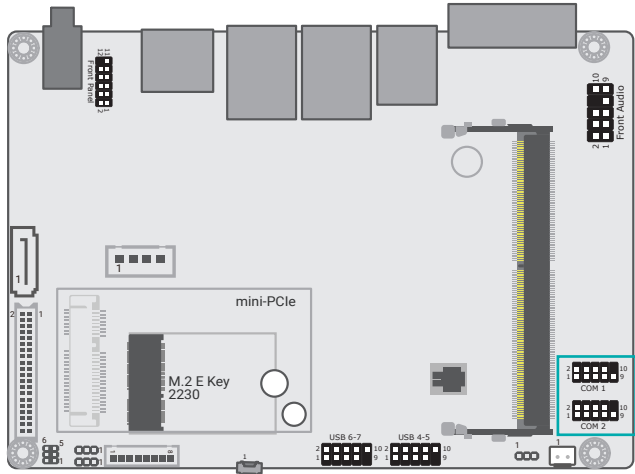

Connecting External Serial Ports

Your COM port may come mounted on a card-edge bracket. Install the card-edge bracket to an available slot at the rear of the system chassis then insert the serial port cable to the COM connector. Make sure the colored stripe on the ribbon cable is aligned with pin 1 of the COM connector.

COM1 (RS232/RS422/RS485)

Pin	Function	Pin	Function
1	MDCD1#	2	MSIN1
3	MSOUT1	4	MDTR1#
5	GND	6	MDSR1#
7	MRTS1#	8	MCTS1#
9	MRI1#	10	N.C.

COM2 (RS232)

Pin	Function	Pin	Function
1	MDCD2-	2	MSIN2-
3	MSO2-	4	MDTR2-
5	GND	6	MDSR2-
7	MRTS2-	8	MCTS2-
9	MRI2-	10	N.C.

COM2 (8bit GPIO Pinout)

(8bit GPIO Pinout)

Pin	Function	Pin	Function
1	DIO6	2	DIO4
3	DIO5	4	DIO3
5	GND	6	DIO1
7	DIO2	8	DIO0
9	DIO7	10	---

\*Change COM2 to 8bit GPIO is available in different part number.

► **Internal I/O Connectors**

Cooling Fan Connectors

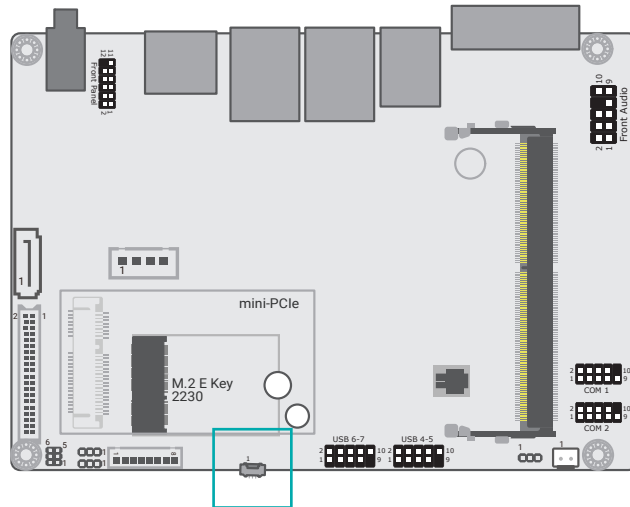

These fan connectors are used to connect cooling fans. The cooling fans will provide adequate airflow throughout the chassis to prevent overheating the CPU and system board components.

Pin	Function
1	SYSFANIN
2	SYSFANOUT
3	GND

► **Internal I/O Connectors**

**Front Panel**

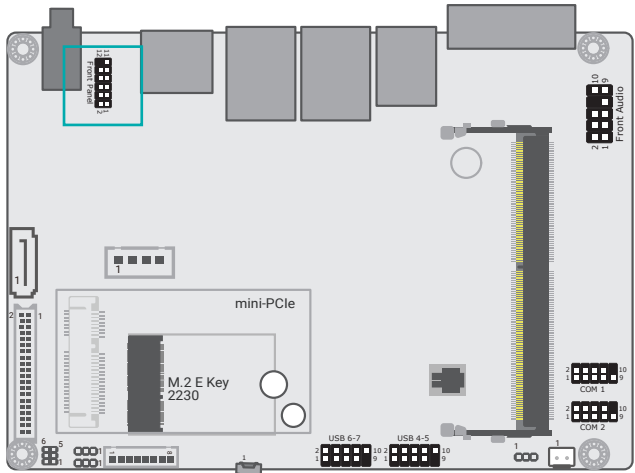

Pin	Function	Pin	Function
1	N.C	2	SUSLED_PWR
3	SATA LED	4	POWER LED
5	HD_LED#	6	SUS_LED#
7	RESET SWITCH	8	POWER BUTTON
9	SYSRST#	10	PWSIN#
11	N.C	12	N.C

**HDD LED - Hard Disk Drive LED**

Lighting of the LED indicates that the hard drive is being accessed.

**RESET - Reset Switch**

This switch allows you to reboot without having to power off the system.

**Power/Standby LED**

When the system's power is on, this LED will light up. When the system is in the S1 (POS - Power On Suspend) state, it will blink at 1-second intervals. When the system is in the S3 (STR - Suspend To RAM) state, it will blink at 4-second intervals.

**Power Button**

This button is used to switch the system's power on or off .

► **Internal I/O Connectors**

**USB 2.0**

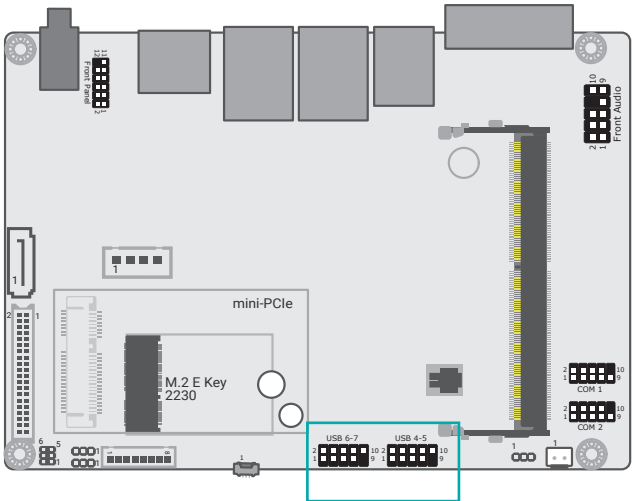

**USB 4/5**

Pin	Function	Pin	Function
1	5V_USB45	2	5V_USB45
3	USB2_4_C_N	4	USB2_5_C_N
5	USB2_4_C_P	6	USB2_5_C_P
7	GND	8	GND
9	N.C	10	N.C

**USB 6/7**

Pin	Function	Pin	Function
1	5V_USB67	2	5V_USB45
3	USB2_6_C_N	4	USB2_7_C_N
5	USB2_6_C_P	6	USB2_7_C_P
7	GND	8	GND
9	N.C	10	N.C

► **Internal I/O Connectors**

**Expansion Slots**

- A Mini-PCIe
- B M.2 B KEY (Optional)
- C M.2 E KEY

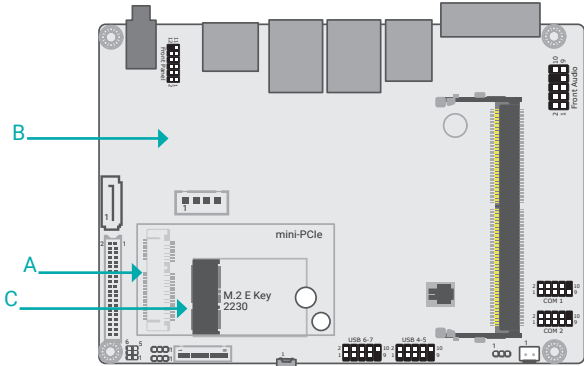

**Mini-PCIe**

Install Mini-PCIe cards such as network cards or other expansion cards.

**M.2 Socket**

The M.2 socket is the Next Generation Form Factor (NGFF) which is designed to support multiple modules and make the M.2 more suitable in application for solid-state storage.

► **Internal I/O Connectors** ► **Expansion Slots**

**Installing the M.2 Module**

Before installing the M.2 module into the M.2 socket, please make sure that the following safety cautions are well-attended.

1. Make sure the PC and all other peripheral devices connected to it has been powered down.
2. Disconnect all power cords and cables.
3. Locate the M.2 socket on the system board
4. Make sure the notch on card is aligned to the key on the socket.
5. Make sure the standoff screw is removed from the standoff.

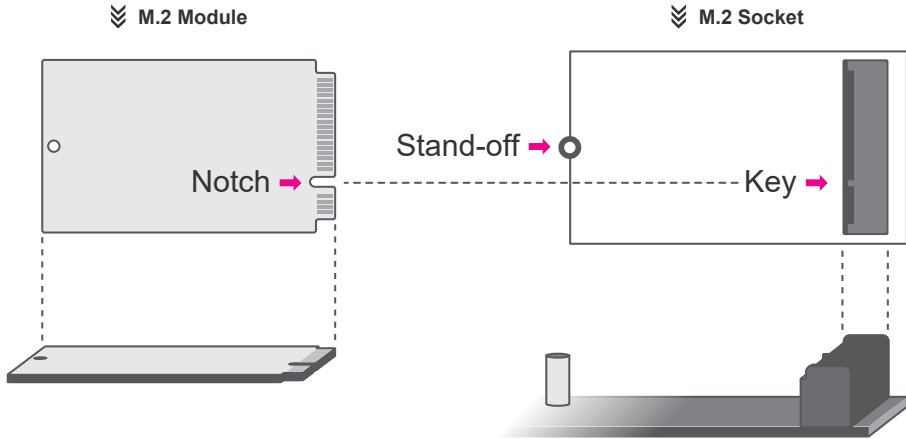

Internal I/O Connectors ▶ Expansion Slots

Please follow the steps below to install the card into the socket.

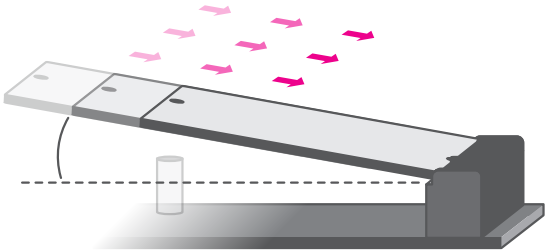

**Step 1:**  
Insert the card into the socket at an angle while making sure the notch and key are perfectly aligned.

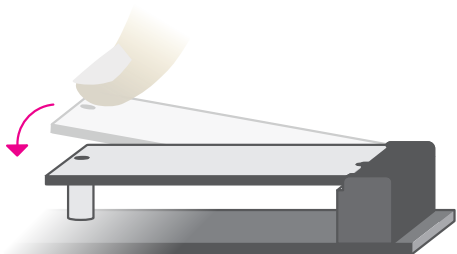

**Step 2:**  
Press the end of the card far from the socket down until against the stand-off.



**Step 3:**  
Screw tight the card onto the stand-off with a screw driver and a stand-off screw until the gap between the card and the stand-off closes up. The card should be lying parallel to the board when it's correctly mounted.

Internal I/O Connectors

Battery Header

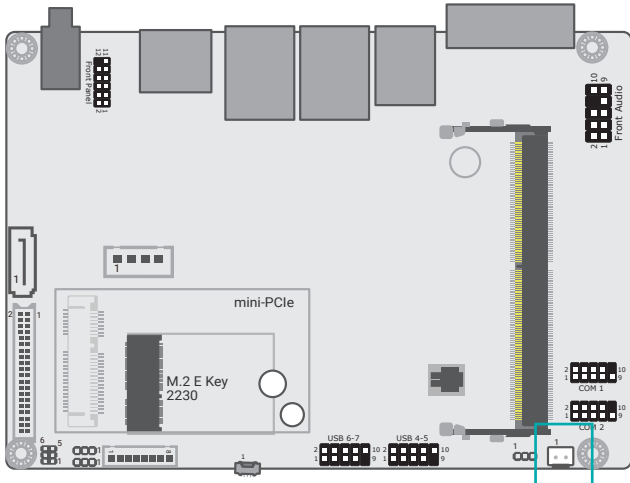

The lithium ion battery addendum supplies power to the real-time clock and CMOS memory as an auxiliary source of power when the main power is shut off. Plug the battery cable into the header.

Pin	Function	Pin	Function
1	V_BAT	2	GND

Safety Measures

- There exists explosion hazard if the battery is incorrectly installed.
- Replace only with the same or equivalent type recommended by the manufacturer.
- Dispose of used batteries according to local ordinances.

► **Internal I/O Connectors**

**LVDS Backlight**

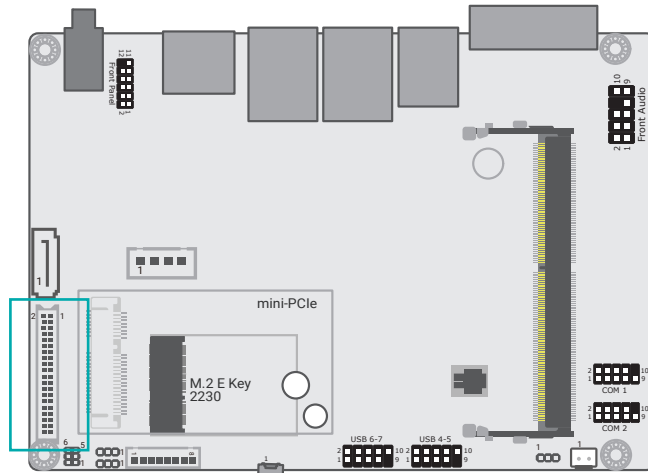

Pin	Function	Pin	Function
1	GND	2	GND
3	LVDSA_LANE3_P	4	LVDSB_LANE3_P
5	LVDSA_LANE3_N	6	LVDSB_LANE3_N
7	GND	8	GND
9	LVDSA_LANE2_P	10	LVDSB_LANE2_P
11	LVDSA_LANE2_N	12	LVDSB_LANE2_N
13	GND	14	GND
15	LVDSA_LANE1_P	16	LVDSB_LANE1_P
17	LVDSA_LANE1_N	18	LVDSB_LANE1_N
19	GND	20	GND
21	LVDSA_LANE0_P	22	LVDSB_LANE0_P
23	LVDSA_LANE0_N	24	LVDSB_LANE0_N
25	GND	26	GND
27	LVDSA_CLK_P	27	LVDSB_CLK_P
29	LVDSA_CLK_N	30	LVDSB_CLK_N
31	GND	32	GND
33	LVDS_DDC_CLK	34	N.C
35	LVDS_DDC_DATA	36	LVDS_3V3
37	GND	38	GND
39	LVDS_PANEL_PWR	40	LVDS_PANEL_PWR



► **Internal I/O Connectors**

eDP

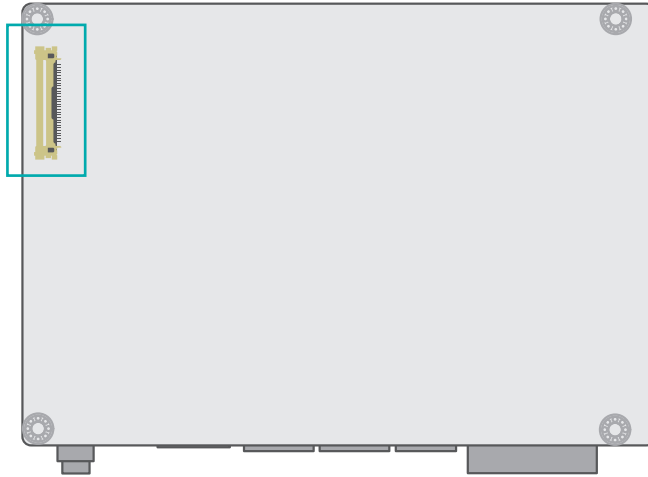

Pin	Function
1	--
2	INV_P WR
3	INV_P WR
4	INV_P WR
5	INV_P WR
6	--
7	--
8	DIMMING_1
9	BLONOFF_1
10	GND
11	GND
12	GND
13	GND
14	eDP_HPDCN
15	GND
16	GND
17	LCD_BIST
18	LVDS_PANEL_PWR
19	LVDS_PANEL_PWR
20	GND
21	eDPB_AUXN
22	eDPB_AUXP
23	GND
24	eDPB_LANE0_C_P
25	eDPB_LANE0_C_N
26	GND
27	eDPB_LANE1_C_P
28	eDPB_LANE1_C_N
29	GND
30	LCD_CABC

## Chapter 3 - BIOS Settings

### ► Overview

The BIOS is a program that takes care of the basic level of communication between the CPU and peripherals. It contains codes for various advanced features found in this system board.

The BIOS allows you to configure the system and save the configuration in a battery-backed CMOS so that the data retains even when the power is off. In general, the information stored in the CMOS RAM of the EEPROM will stay unchanged unless a configuration change has been made such as a hard drive replaced or a device added.

It is possible that the CMOS battery will fail causing CMOS data loss. If this happens, you need to install a new CMOS battery and reconfigure the BIOS settings.



**Note:**

The BIOS is constantly updated to improve the performance of the system board; therefore the BIOS screens in this chapter may not appear the same as the actual one. These screens are for reference purpose only.

### Default Configuration

Most of the configuration settings are either predefined according to the Load Optimal Defaults settings which are stored in the BIOS or are automatically detected and configured without requiring any actions. There are a few settings that you may need to change depending on your system configuration.

### Entering the BIOS Setup Utility

The BIOS Setup Utility can only be operated from the keyboard and all commands are keyboard commands. The commands are available at the right side of each setup screen.

The BIOS Setup Utility does not require an operating system to run. After you power up the system, the BIOS message appears on the screen and the memory count begins. After the memory test, the message "Press DEL to run setup" will appear on the screen. If the message disappears before you respond, restart the system or press the "Reset" button. You may also restart the system by pressing the <Ctrl> <Alt> and <Del> keys simultaneously.

### Legends

Keys	Function
Right / Left arrow	Move the highlight left or right to select a menu
Up / Down arrow	Move the highlight up or down between submenus or fields
<Enter>	Enter the highlighted submenu
+ (plus key)/F6	Scroll forward through the values or options of the highlighted field
- (minus key)/F5	Scroll backward through the values or options of the highlighted field
<F1>	Display general help
<F2>	Display previous values
<F9>	Optimized defaults
<F10>	Save and Exit
<Esc>	Return to previous menu

### Scroll Bar

When a scroll bar appears to the right of the setup screen, it indicates that there are more available fields not shown on the screen. Use the up and down arrow keys to scroll through all the available fields.

### Submenu

When "►" appears on the left of a particular field, it indicates that a submenu which contains additional options are available for that field. To display the submenu, move the highlight to that field and press <Enter>.

► Main

The Main menu is the first screen that you will see when you enter the BIOS Setup Utility.

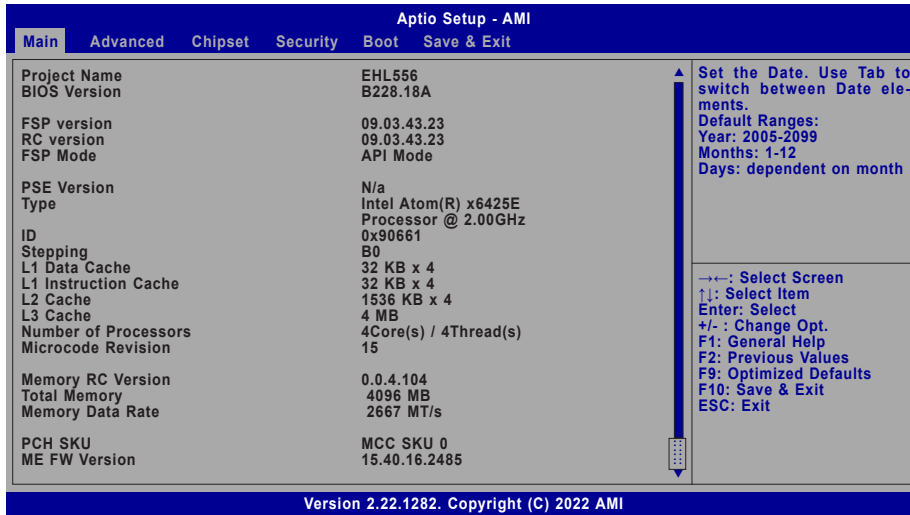

**System Date**

The date format is <month>, <date>, <year>. Press "Tab" to switch to the next field and press "-" or "+" to modify the value.

**System Time**

The time format is <hour>, <minute>, <second>. The time is based on the 24-hour military-time clock. For example, 1 p.m. is 13:00:00. Hour displays hours from 00 to 23. Minute displays minutes from 00 to 59. Second displays seconds from 00 to 59.

► Advanced

The Advanced menu allows you to configure your system for basic operation. Some entries are defaults required by the system board, while others, if enabled, will improve the performance of your system or let you set some features according to your preference.



**Important:**  
Setting incorrect field values may cause the system to malfunction.

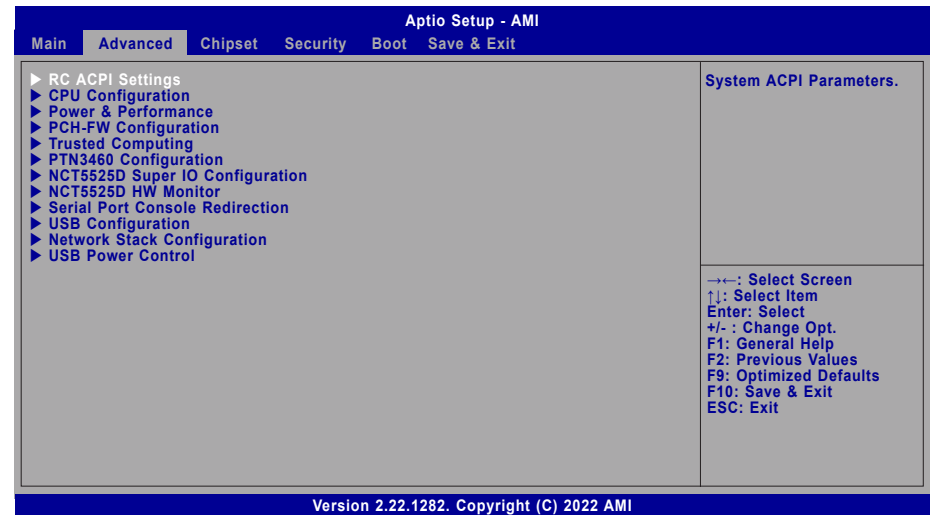

► **Advanced**

RC ACPI Configuration

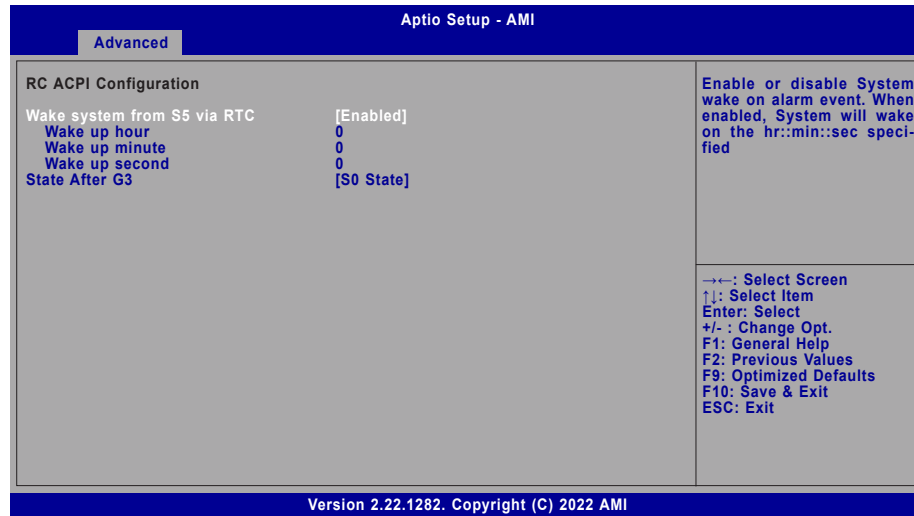

**Wake system from S5**

When Enabled, the system will automatically power up at a designated time every day. Once it's switched to [Enabled], please set up the time of day — hour, minute, and second — for the system to wake up.

**State After G3**

This field is to specify what state the system should be in when power is re-applied after a power failure (G3, the mechanical-off, state).

► **Advanced**

CPU Configuration

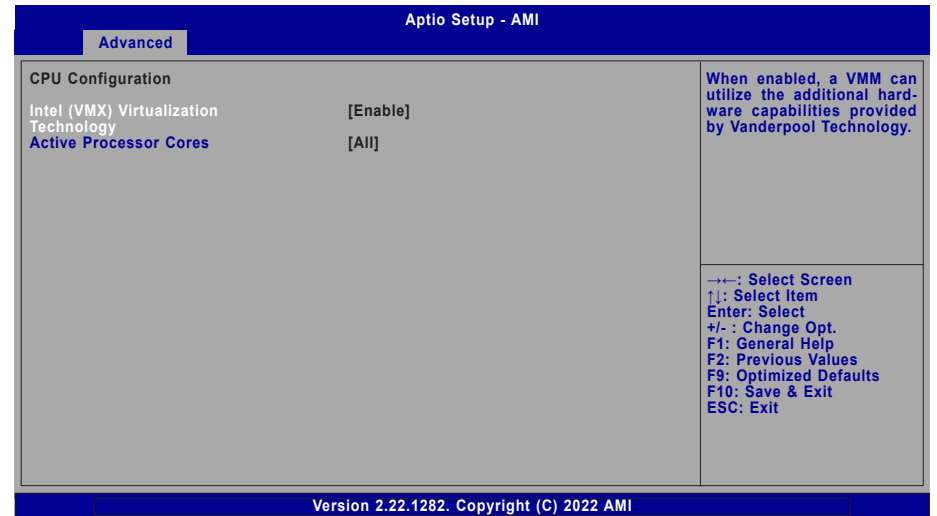

**Intel (VMX) Virtualization Technology**

When this field is set to Enabled, the VMM can utilize the additional hardware capabilities provided by Vanderpool Technology.

**Active Processor Cores**

Select number of cores to enable in each processor package.



**Note:**

Some of the fields may not be available when the features are not supported by the equipped CPU.

► **Advanced**

Power & Performance

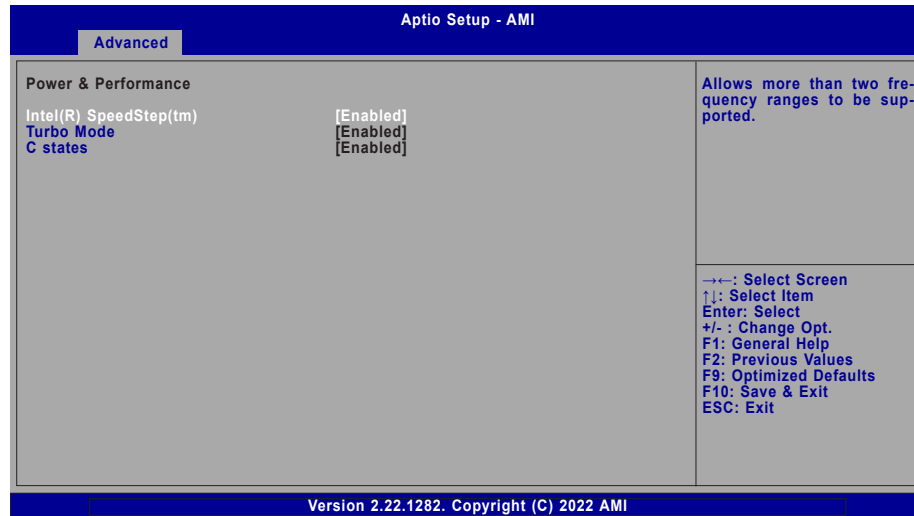

**Intel(R) SpeedStep(tm)**

This field is used to enable or disable the Intel SpeedStep® Technology, which helps optimize the balance between system's power consumption and performance. After it is enabled in the BIOS, EIST features can then be enabled via the operating system's power management.

**Turbo Mode**

Enable or disable turbo mode of the processor. This field will only be displayed when EIST is enabled.

**C states**

Enable or disable CPU Power Management. It allows CPU to enter "C states" when it's idle and nothing is executing.

► **Advanced**

PCH-FW Configuration

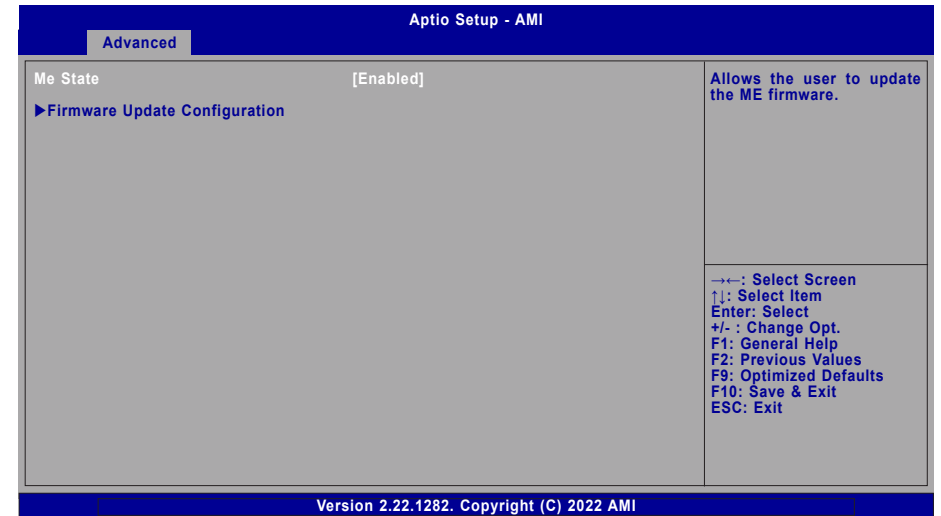

**Me State**

This field is used to enable or disable the ME FW Image Re-Flash function, which allows the user to update the ME firmware.

► **Firmware Update Configuration**

To config firmware update.

**Me FW Image Re-Flash**

This field is used to enable or disable the ME FW Image Re-Flash function, which allows the user to update the ME firmware.

► Advanced

Trusted Computing

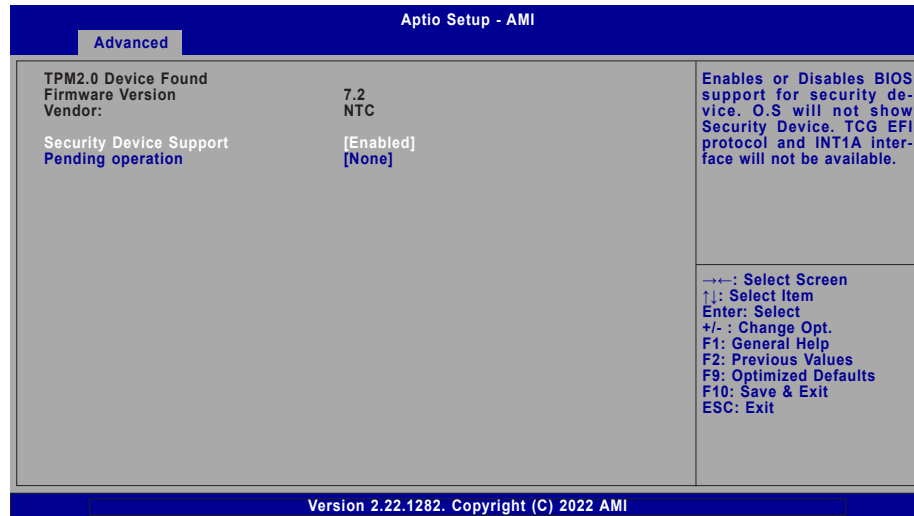

**Security Device Support**

This field is used to enable or disable BIOS support for the security device such as an TPM 2.0 to achieve hardware-level security via cryptographic keys.

**Pending operation**

To clear the existing TPM encryption, select "TPM Clear" and restart the system. This field is not available when "Security Device Support" is disabled.

► Advanced

PTN3460 Configuration

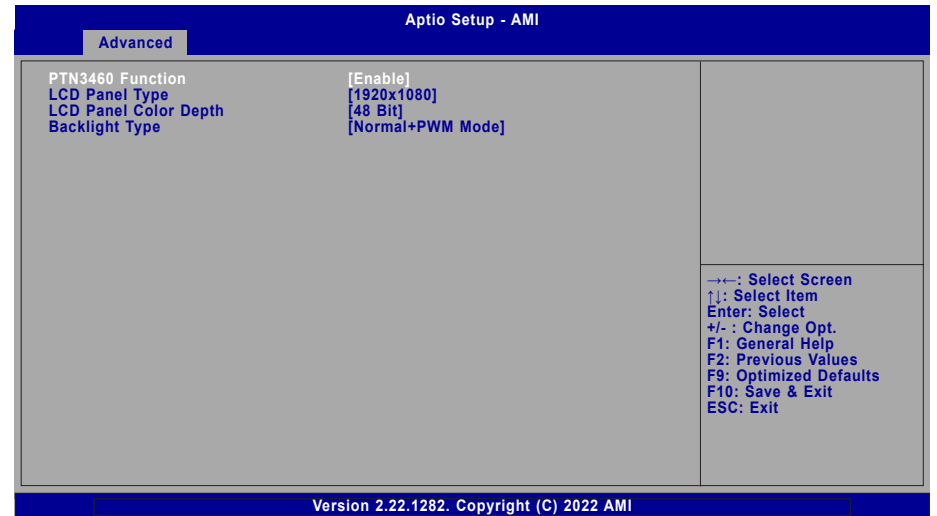

**PTN3460 Function**

Enable or Disable PTN3460 LCD Features. When this field is disabled, the following fields will remain hidden.

**LCD Panel Type**

Select the resolution of the LCD Panel – 800X480, 800X600, 1024X768, 1366X768, 1280X1024, 1920X1080, or 1920X1200.

**LCD Panel Color Depth**

Select the color depth of the LCD Panel – 18 Bit, 24 Bit, 36 Bit, 48 Bit.

**Backlight Type**

Select the backlight type of the LCD Panel –  
 Normal + PWM  
 Normal + DC



**Note:**

The configuration must match the specifications of your LCD Panel in order for the LCD Panel to display properly.

▶ **Advanced**

NCT5525D Super IO Configuration

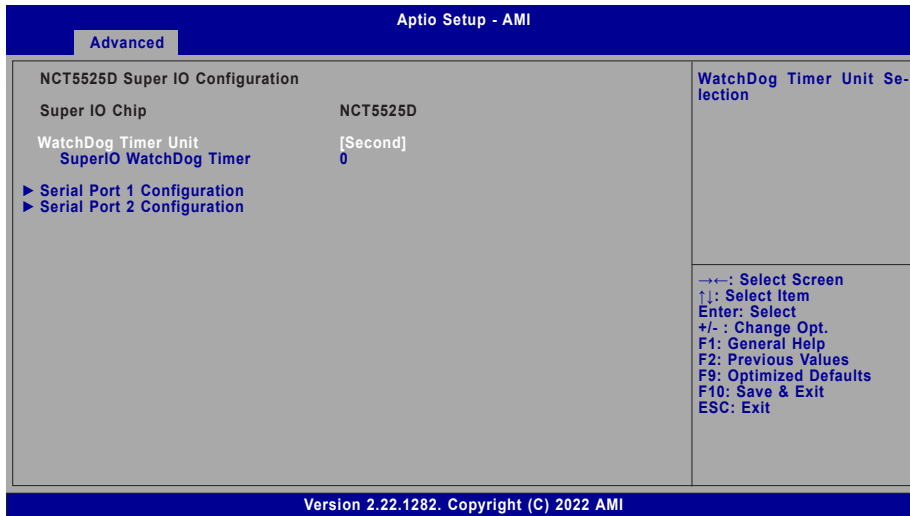

**WatchDog Timer Unit**

Select WatchDog Timer Unit – Second or Minute.

**SuperIO WatchDog Timer**

Set SuperIO WatchDog Timer Timeout value. The range is from 0 (disabled) to 255.



**Note:**

The sub-menus are detailed in following sections.

▶ **Advanced** ▶ **NCT5525D Super IO Configuration**

▶ **Serial Port Configuration**

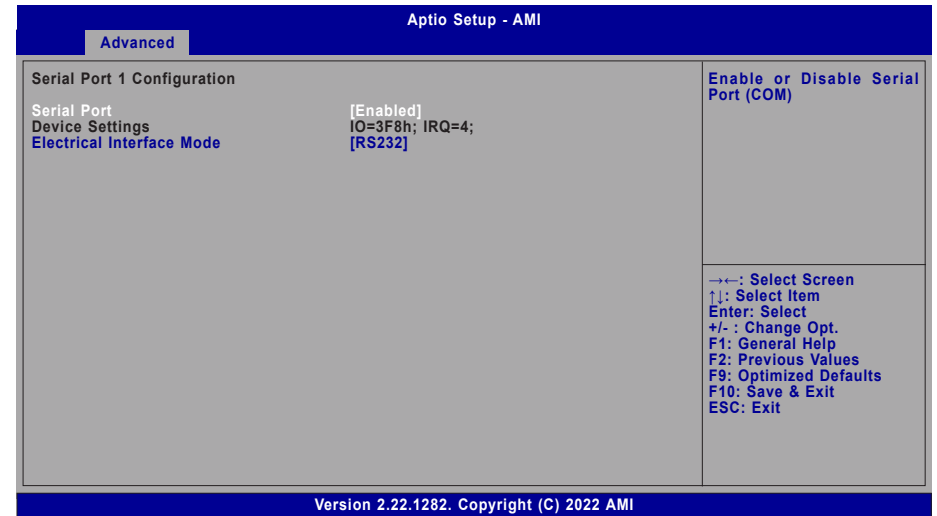

**Serial Port**

Enable or disable the current serial COM port.

**Electrical Interface Mode**

Choose mode between RS232 / RS485 / RS422

► Advanced

NCT5525D HW Monitor

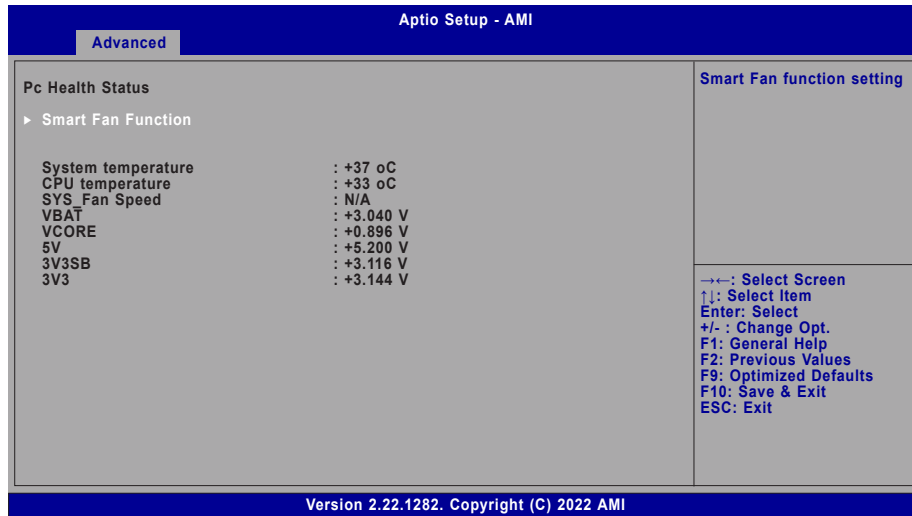

► Advanced ► NCT6126D HW Monitor

► Smart Fan Function

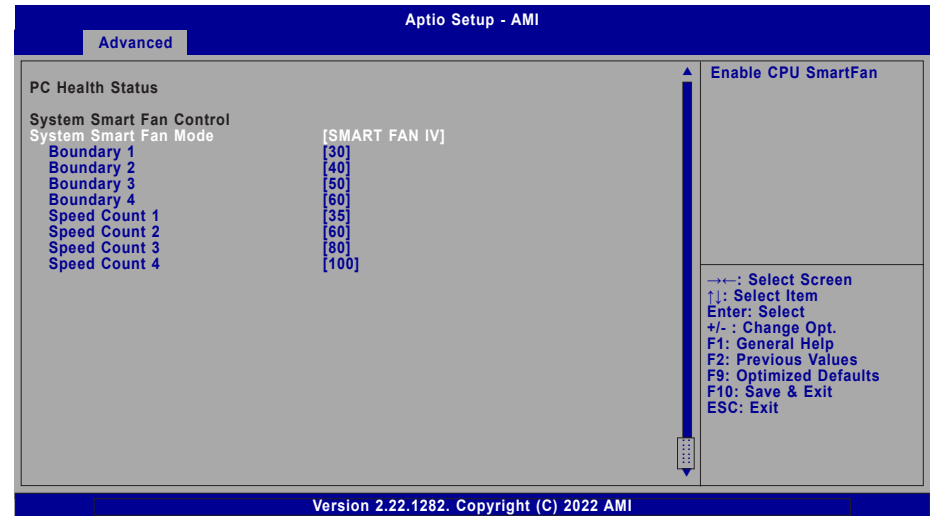

Smart Fan is a fan speed moderation strategy dependent on the current system temperature. When the system temperature goes higher than the Boundary setting, the fan speed will be turned up to the setting of the Fan Speed Count that bears the same index as the Boundary field.

▼ SYS Smart Fan Control

**Boundary 1 to Boundary 4**

Set the boundary temperatures that determine the fan speeds accordingly, the value ranging from 0-127°C. For example, when the system temperature reaches Boundary 1 setting, the fan speed will be turned up to the designated speed of the Fan Speed Count 1 field.

**Fan Speed Count 1 to Fan Speed Count 4**

Set the fan speed, the value ranging from 1-100%, 100% being full speed. The fans will operate according to the specified boundary temperatures above-mentioned.

▼ SYS Smart Fan/CPU Smart Fan Control = [Disabled]

**Fix Fan Speed Count**

Set the fan speed, the value ranging from 1-100%, 100% being full speed. The fans will always operate at the specified speed regardless of gauged temperatures.



► **Advanced**

Serial Port Console Redirection

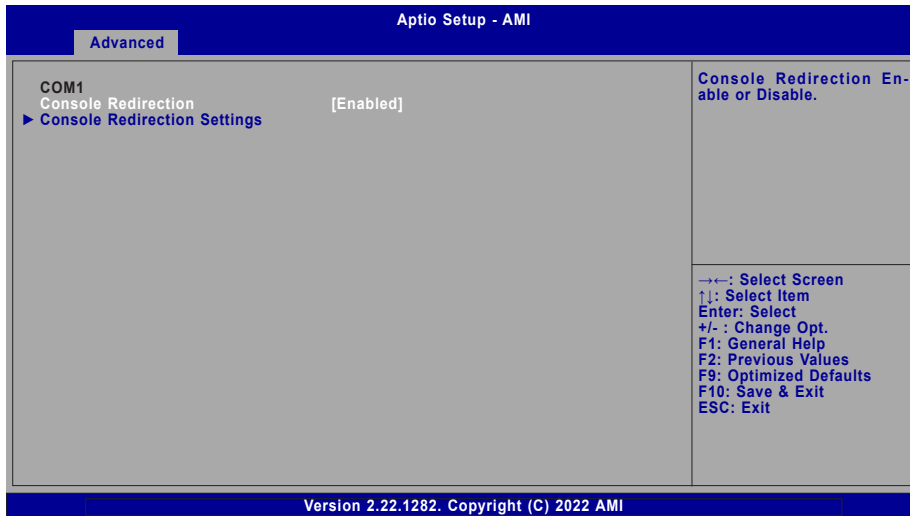

**Console Redirection**

By enabling Console Redirection of a COM port, the sub-menu of console redirection settings will become available for configuration as detailed in the following.

► **Advanced** ► **Serial Port Console Redirection**

► **Console Redirection Settings**

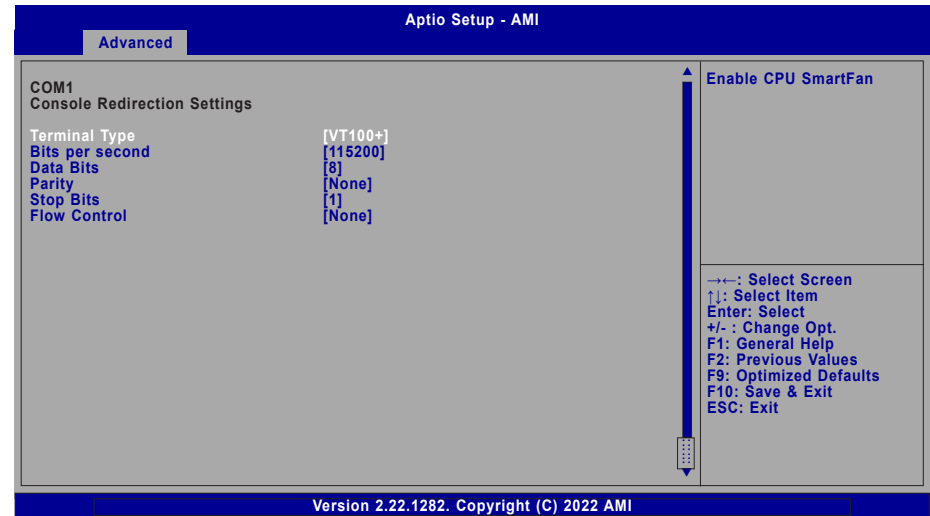

Configure the serial settings of the current COM port.

**Terminal Type**

Select terminal type: VT100, VT100+, VT-UTF8 or ANSI.

**Bits per second**

Select serial port transmission speed: 9600, 19200, 38400, 57600 or 115200.

**Data Bits**

Select data bits: 7 bits or 8 bits.

**Parity**

Select parity bits: None, Even, Odd, Mark or Space.

**Stop Bits**

Select stop bits: 1 bit or 2 bits.

**Flow Control**

Select flow control type: None or Hardware RTS/CTS.

► **Advanced**

USB Configuration

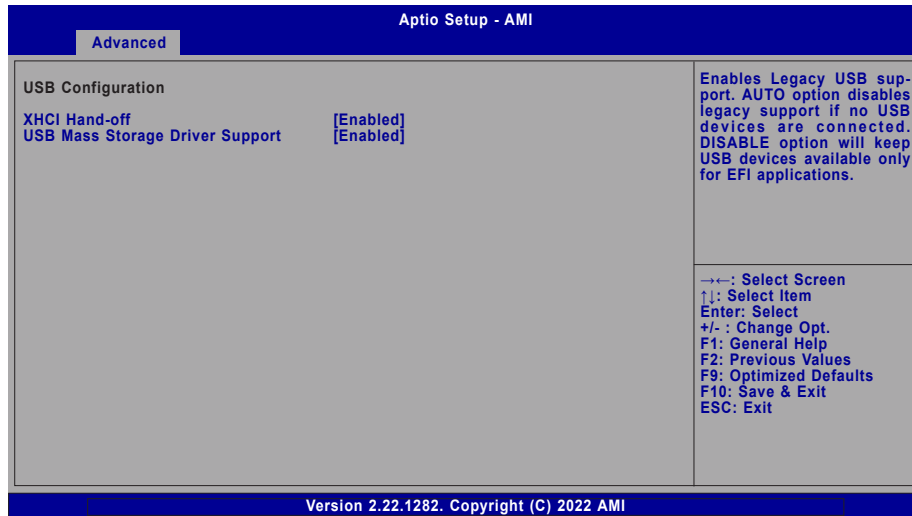

**XHCI Hand-off**

Enable or disable XHCI Hand-off.

**USB Mass Storage Driver Support**

Enable or disable USB Mass Storage Driver Support.

► **Advanced**

Network Stack Configuration

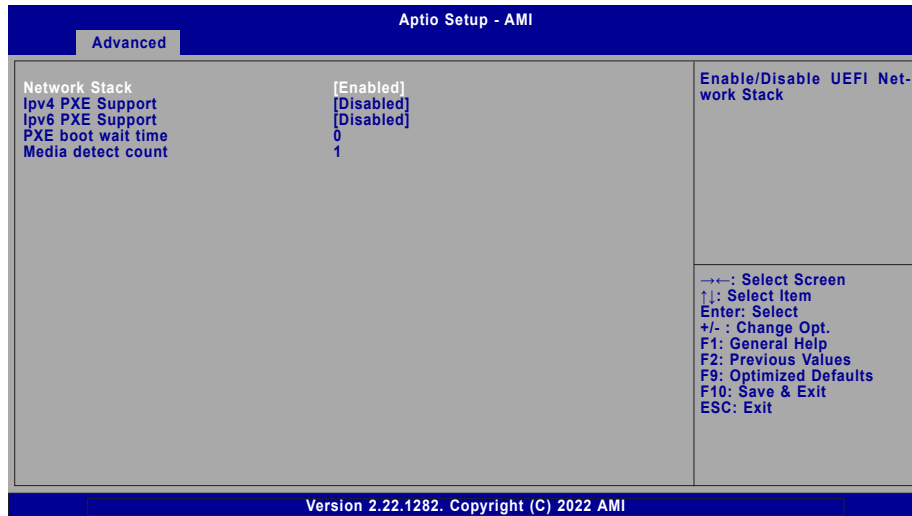

**Network Stack**

Enable or disable UEFI network stack. The following fields will appear when this field is enabled.

**Ipv4 PXE Support**

Enable or disable IPv4 PXE boot support. If disabled, IPv4 PXE boot support will not be available.

**Ipv6 PXE Support**

Enable or disable IPv6 PXE boot support. If disabled, IPv6 PXE boot support will not be available.

**PXE boot wait time**

Set the wait time in seconds to press ESC key to abort the PXE boot. Use either +/- or numeric keys to set the value.

**Media detect count**

Set the number of times the presence of media will be checked. Use either +/- or numeric keys to set the value.

► **Advanced**

USB Power Control

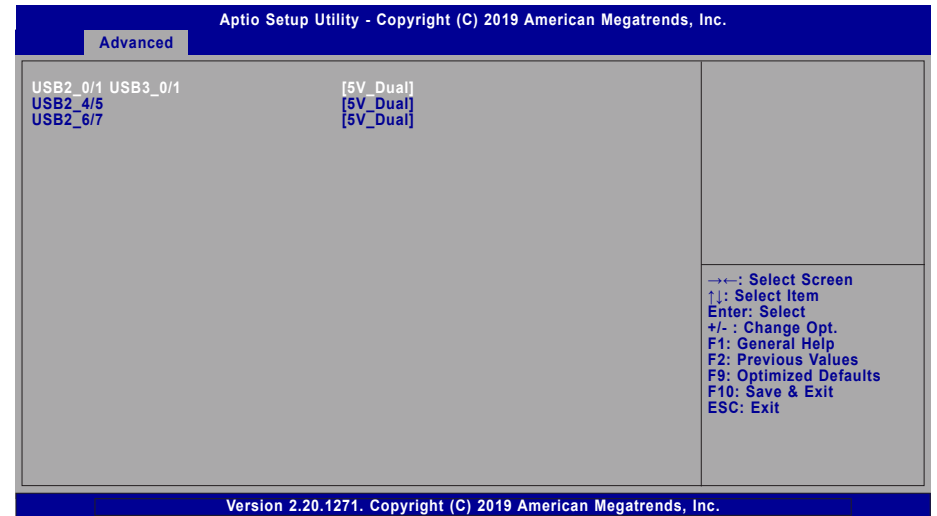

**5V / 5V\_DUAL**

5V Dual supports wake up from S3/S4 state by USB keyboard or mouse while 5V does not.

► Chipset

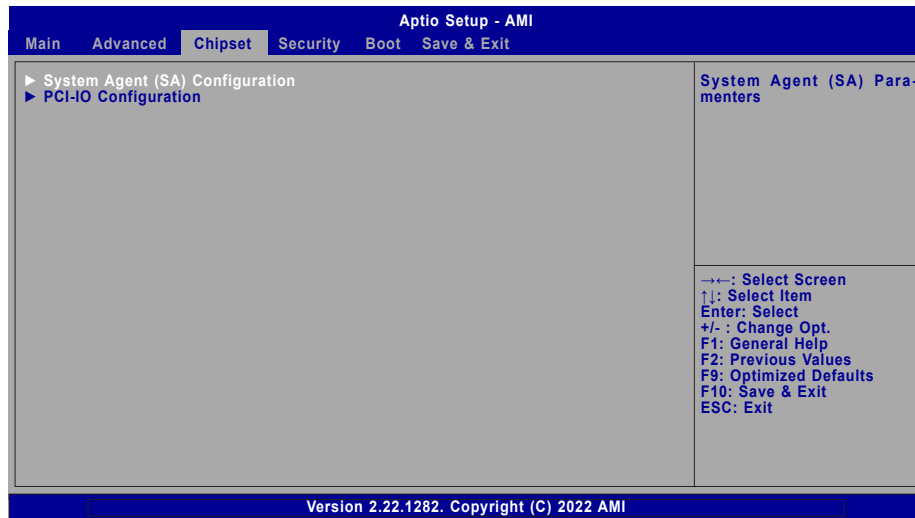

► Chipset ► System Agent(SA) Configuration ► Memory Configuration

Memory Configuration

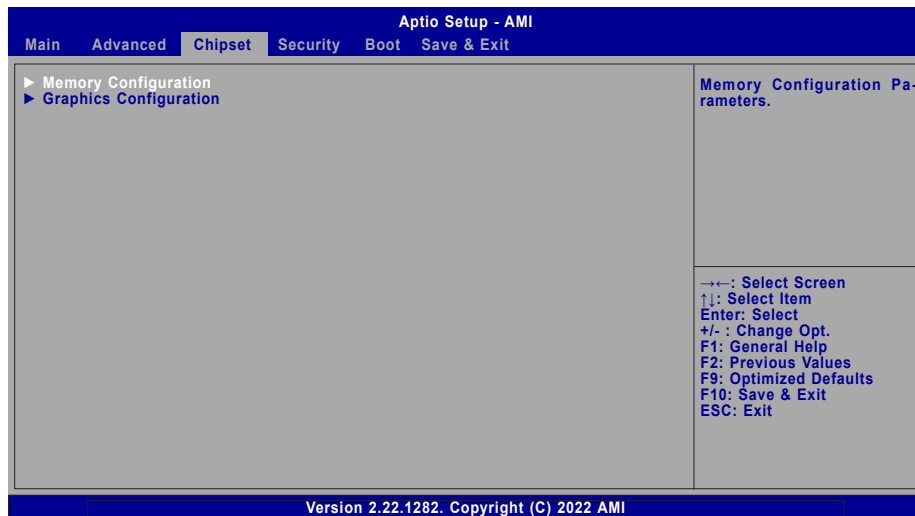
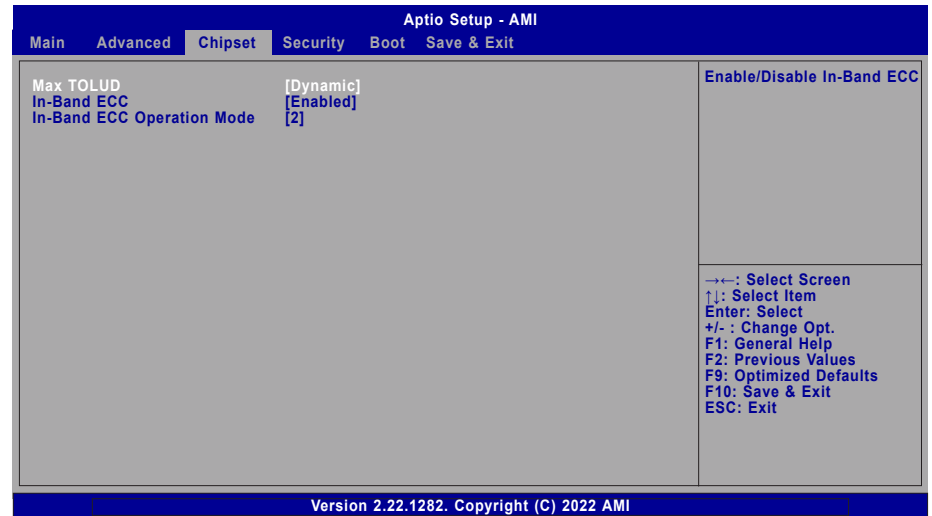

**Max TOLUD**

Maximum Value of TOLUD. Dynamic assignment would adjust TOLUD automatically based on largest MMIO length of installed graphic controller.

**In-Band ECC**

Enable or disable In-Band ECC.

**In-Band Operation Mode**

- 0: Functional Mode protects requests based on the address range.
- 1: Makes all requests none protected and ignore range checks.
- 2: Makes all requests protected and ignore range checks.

► **Chipset** ► **System Agent(SA) Configuration** ► **Graphics Configuration**

Graphics Configuration

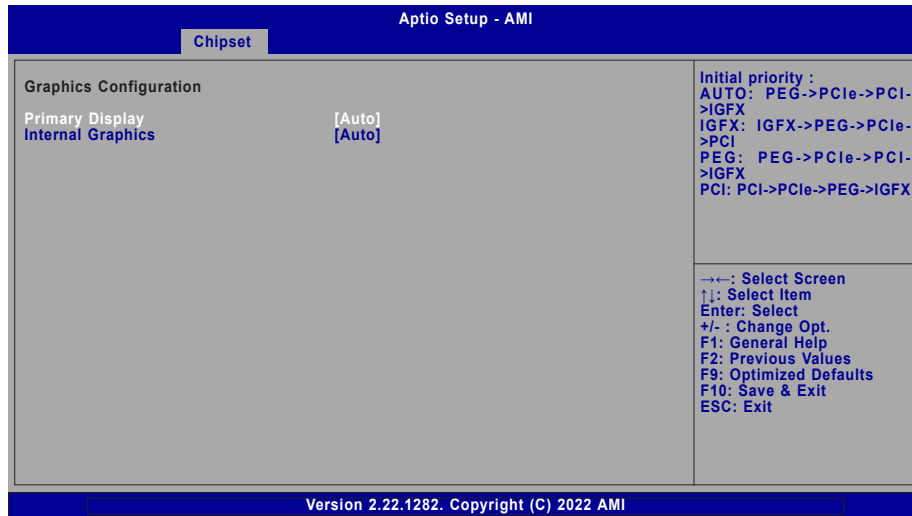

**Primary Display**

Select which of IGFX/PEG/PCI Graphics device to be the primary display.

**Internal Graphics**

Keep IGFX enabled based on the setup options.

► Chipset ► PCH-IO Configuration

PCH-IO Configuration

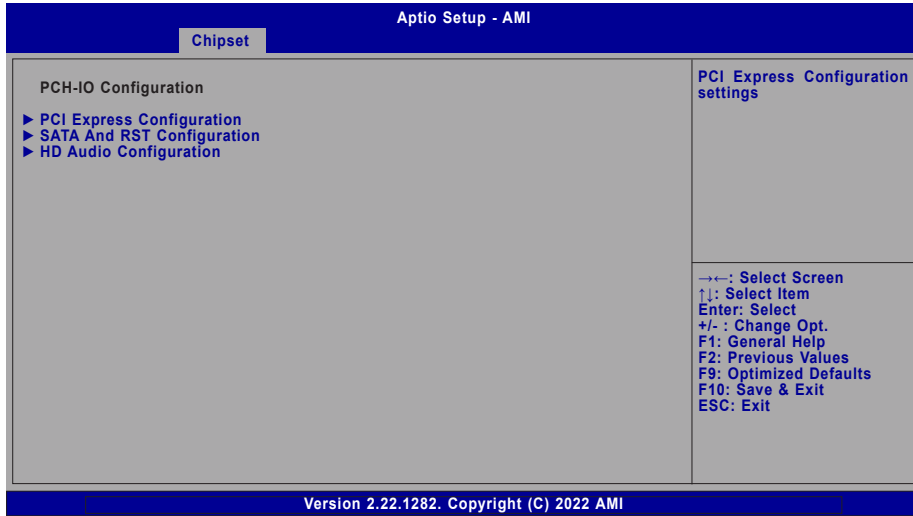

► Chipset ► PCH-IO Configuration ► PCI Express Configuration

PCI Express Configuration

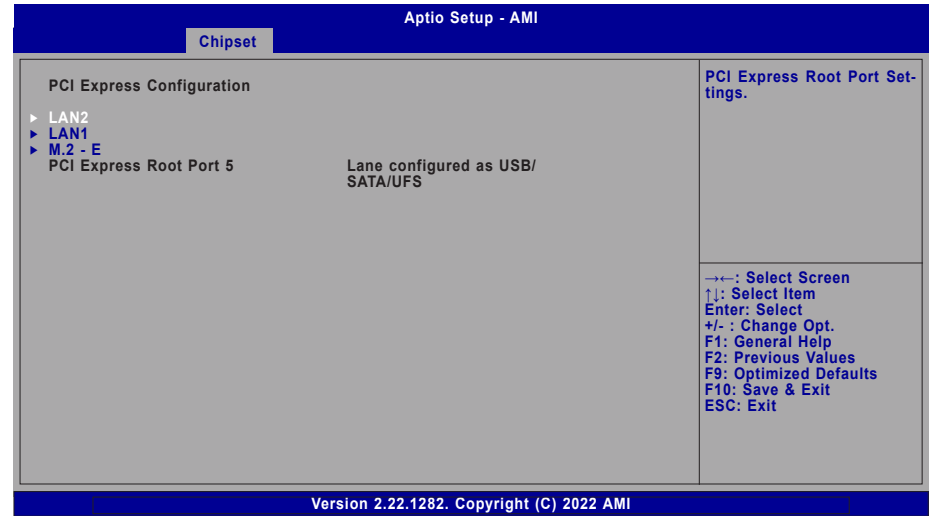

**Note:**  
 The sub-menus are detailed in following sections.

Select one of the PCI Express channels and press enter to configure the following settings.

**PCI Express Devices**

Enable or disable the PCI Express Root Port.

**PCIe Speed**

Select PCIe Speed of the current port – AUTO, Gen1, Gen 2, or Gen3. Gen 3 is only available for the PCIe1 port. This field may not appear when the speed of the port is not configurable.

► Chipset ► PCH-IO Configuration ► SATA And RST Configuration

SATA And RST Configuration

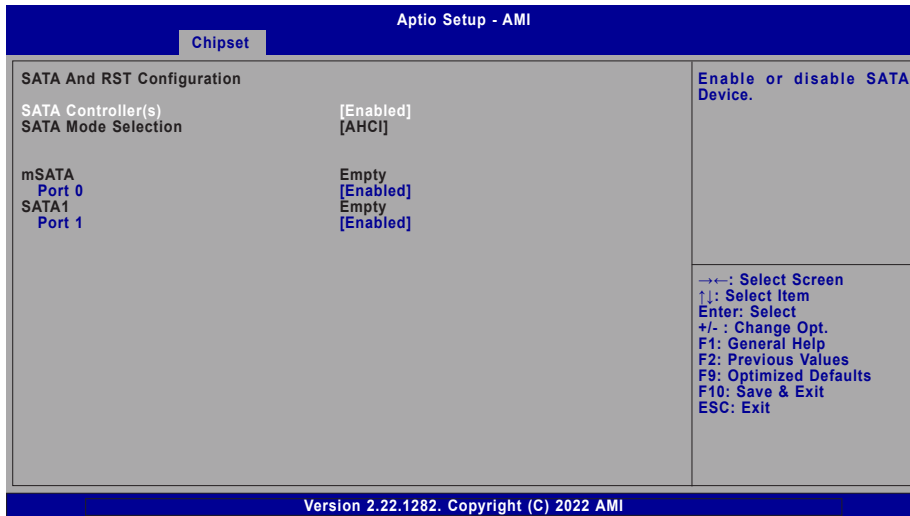

**SATA Controller(s)**

This field is used to enable or disable the Serial ATA controller.

**SATA Mode Selection**

The mode selection determines how the SATA controller(s) operates.

- **AHCI** This option allows the Serial ATA controller(s) to use AHCI (Advanced Host Controller Interface).

► Chipset ► PCH-IO Configuration ► HD Audio Configuration

HD Audio Configuration

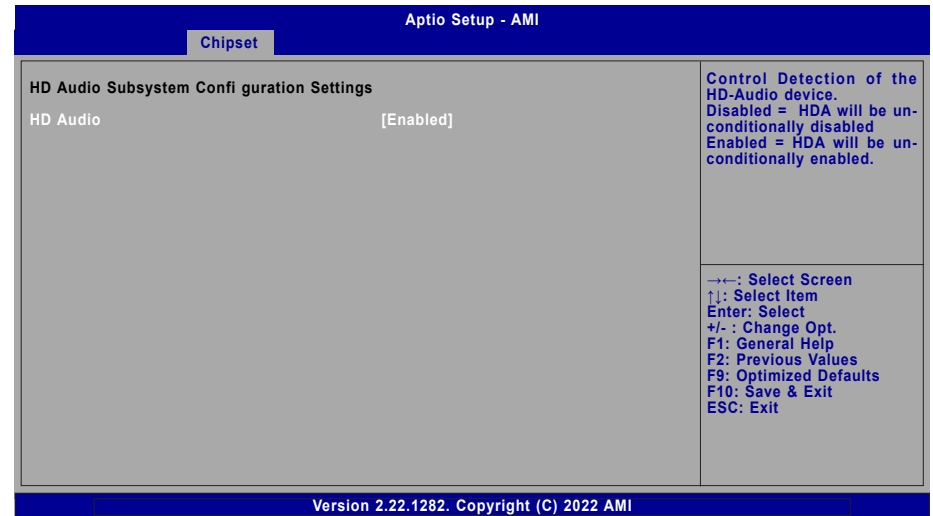

**HD Audio**

Control the detection of the HD Audio device.

- **Disabled** HDA will be unconditionally disabled.
- **Enabled** HDA will be unconditionally enabled.

► Security

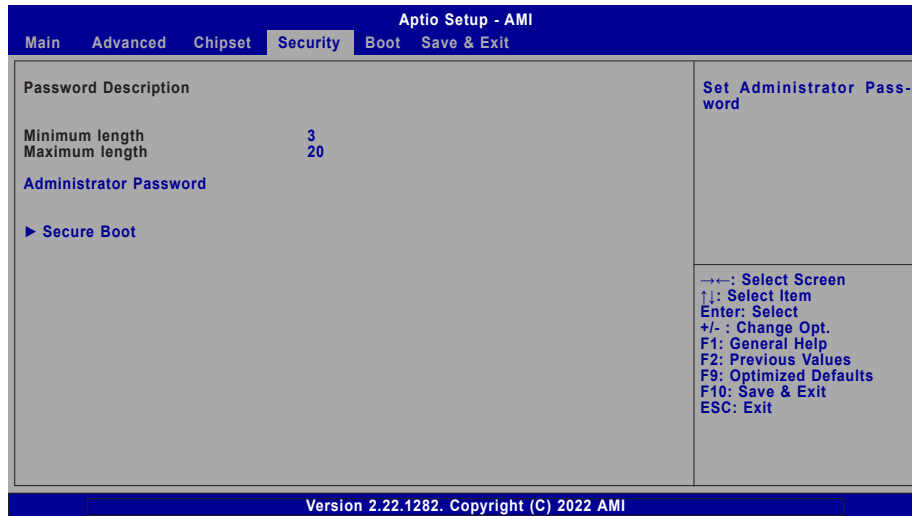

**Administrator Password**

Set the administrator password. To clear the password, input nothing and press enter when a new password is asked. Administrator Password will be required when entering the BIOS.

► Security

Secure Boot

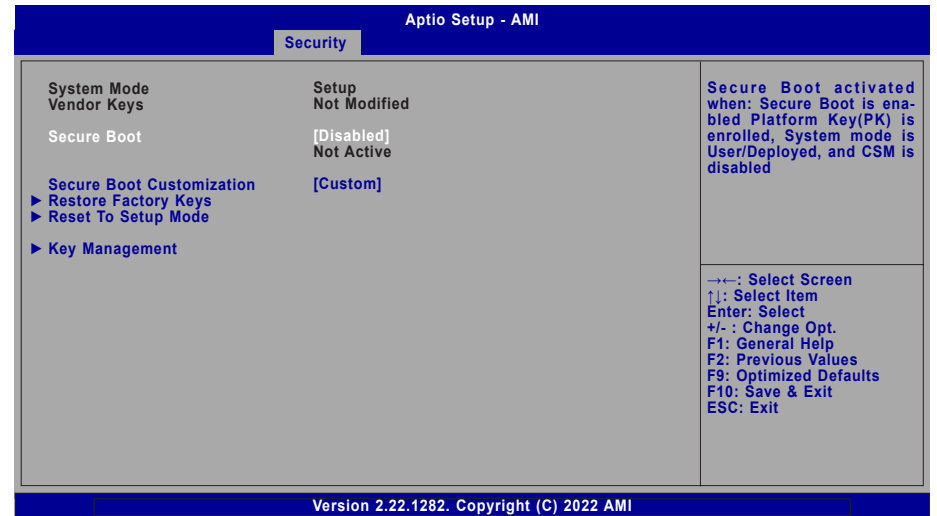

**Secure Boot**

The Secure Boot store a database of certificates in the firmware and only allows the OSeS with authorized signatures to boot on the system. To activate Secure Boot, please make sure that “Secure Boot” is “[Enabled]”, Platform Key (PK) is enrolled, “System Mode” is “User”, and CSM is disabled. After enabling/disabling Secure Boot, please save the configuration and restart the system. When configured and activated correctly, the Secure Boot status will be “Active”.

**Secure Boot Customization**

Select the secure boot mode – Standard or Custom. When set to Custom, the following fields will be configurable for the user to manually modify the key database.

**Restore Factory Keys**

Force system to User Mode. Load OEM-defined factory defaults of keys and databases onto the Secure Boot. Press Enter and a prompt will show up for you to confirm.

**Reset To Setup Mode**

Clear the database from the NVRAM, including all the keys and signatures installed in the Key Management menu. Press Enter and a prompt will show up for you to confirm.



► Security ► Secure Boot

► Key Management

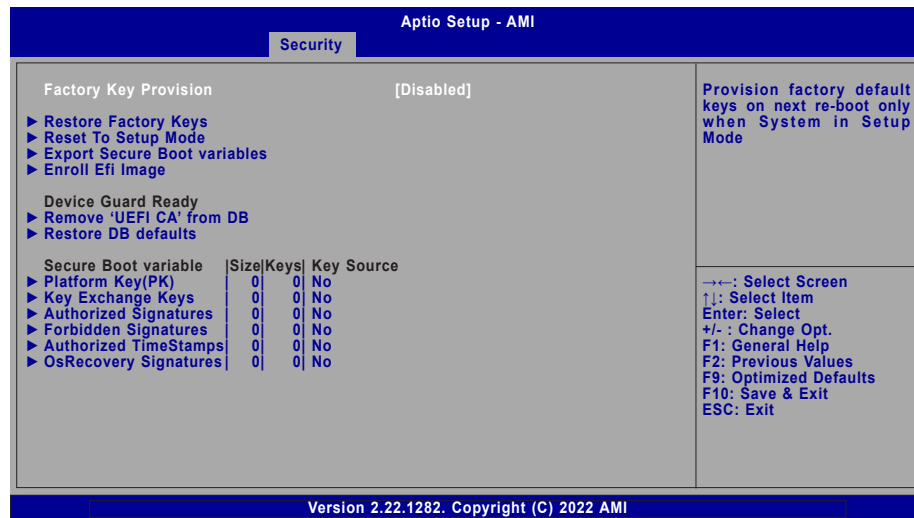

- “PK” for Platform Keys
- “KEK” for Key Exchange Keys
- “db” for Authorized Signatures
- “dbx” for Forbidden Signatures

**Enroll Efi Image**

Allow the image to run in Secure Boot mode. Enroll SHA256 Hash certificate of a PE image into Authorized Signature Database (db). Press Enter and select a storage device listed in the pop-up menu, select a directory, and then select the EFI Image document.

**Remove ‘UEFI CA’ from DB**

Remove Microsoft UEFI CA from the Authorized Signature database. For systems that support Device Guard, Microsoft UEFI CA must NOT be included in the Authorized Signature database.

**Restore DB defaults**

Press Enter to restore the database variable to factory defaults.

Manually configure the following keys and signatures. Move the cursor to the field and press Enter, and then a pop-up menu will show up.

**Platform Key(PK), Key Exchange Keys, Authorized Signatures, Forbidden Signatures, Authorized TimeStamps, OsRecovery Signatures**

- **Details** List the information of enrolled keys and signatures
- **Export** Save the key or signature as a file to the root directory of a file system. The saved files will be named automatically according to the type of key/signature as previously listed in the “Export Secure Boot Variables”.
- **Update** Load factory default database
- **Append** Enroll keys and signatures from a file system
- **Delete** Delet keys and signatures

**Factory Key Provision**

Enable or disable the provision factory default keys on next re-start. This will only take place when the “System Mode” in the previous menu is in “Setup”, which can be achieved by moving the cursor to the “Reset To Setup Mode” and press Enter.

**Restore Factory Keys**

Force system to User Mode. Configure NVRAM to contain OEM-defined factory default Secure Boot keys.

**Reset To Setup Mode**

Clear the database from the NVRAM, including all the keys and signatures installed in the Key Management menu. Press Enter and a prompt will show up for you to confirm.

**Export Secure Boot variables**

Export the Secure Boot settings (i.e. all keys and signatures) as files to the root directory of a file system device. Press Enter and select a storage device listed in the pop-up menu. The saved files will be named automatically according to the type of key/signature as listed below.

► **Boot**

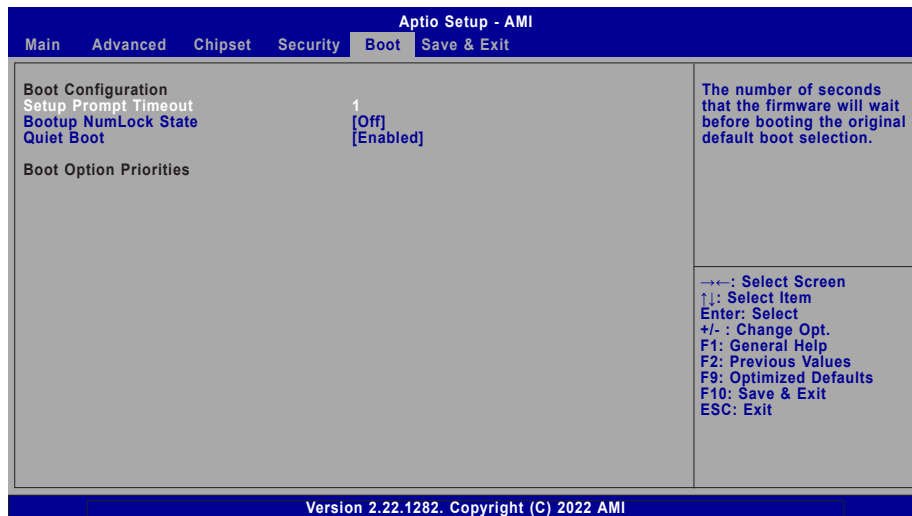

**Setup Prompt Timeout**

Set the number of seconds to wait for the setup activation key. 65535 (0xFFFF) denotes indefinite waiting.

**Bootup NumLock State**

Select the keyboard NumLock state: On or Off.

**Quiet Boot**

This section is used to enable or disable quiet boot option.

**Boot Option Priorities**

Rearrange the system boot order of available boot devices.

► **Save & Exit**

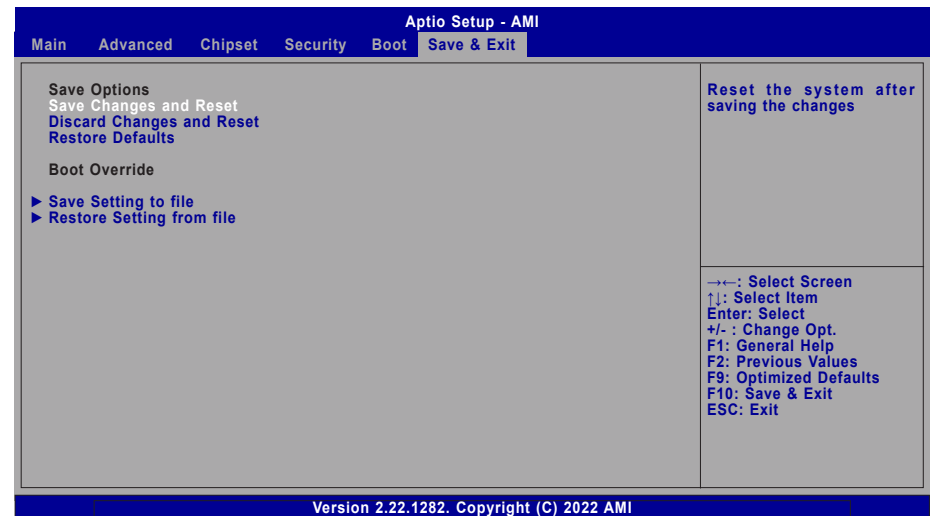

**Save Changes and Reset**

To save the changes, select this field and then press <Enter>. A dialog box will appear. Select Yes to reset the system after saving all changes made.

**Discard Changes and Reset**

To discard the changes, select this field and then press <Enter>. A dialog box will appear. Select Yes to reset the system setup without saving any changes.

**Restore Defaults**

To restore and load the optimized default values, select this field and then press <Enter>. A dialog box will appear. Select Yes to restore the default values of all the setup options.

**Boot Override**

Move the cursor to an available boot device and press Enter, and then the system will immediately boot from the selected boot device. The Boot Override function will only be effective for the current boot. The "Boot Option Priorities" configured in the Boot menu will not be changed.

► **Save Setting to file**

Select this option to save BIOS configuration settings to a USB flash device.

► **Restore Setting from file**

This field will appear only when a USB flash device is detected. Select this field to restore setting from the USB flash device.

## ► Updating the BIOS

To update the BIOS, you will need the new BIOS file and a flash utility. Please contact technical support or your sales representative for the files and specific instructions about how to update BIOS with the flash utility. For updating AMI BIOS in UEFI mode, you may refer to the how-to video at <https://www.dfi.com/Knowledge/Video/5>.

## ► Notice: BIOS SPI ROM

- 1. The Intel® Management Engine has already been integrated into this system board. Due to the safety concerns, the BIOS (SPI ROM) chip cannot be removed from this system board and used on another system board of the same model.
- 2. The BIOS (SPI ROM) on this system board must be the original equipment from the factory and cannot be used to replace one which has been utilized on other system boards.
- 3. If you do not follow the methods above, the Intel® Management Engine will not be updated and will cease to be effective.



**Note:**

- a. You can take advantage of flash tools to update the default configuration of the BIOS (SPI ROM) to the latest version anytime.
- b. When the BIOS IC needs to be replaced, you have to populate it properly onto the system board after the EEPROM programmer has been burned and follow the technical person's instructions to confirm that the MAC address should be burned or not.