

# **AL9A8**

## **COM Express Mini Module User's Manual**

## Copyright

This publication contains information that is protected by copyright. No part of it may be reproduced in any form or by any means or used to make any transformation/adaptation without the prior written permission from the copyright holders.

This publication is provided for informational purposes only. The manufacturer makes no representations or warranties with respect to the contents or use of this manual and specifically disclaims any express or implied warranties of merchantability or fitness for any particular purpose. The user will assume the entire risk of the use or the results of the use of this document. Further, the manufacturer reserves the right to revise this publication and make changes to its contents at any time, without obligation to notify any person or entity of such revisions or changes.

Changes after the publication's first release will be based on the product's revision. The website will always provide the most updated information.

© 2021. All Rights Reserved.

## Trademarks

Product names or trademarks appearing in this manual are for identification purpose only and are the properties of the respective owners.

## COM Express Specification Reference

PICMG® COM Express® Module Base Specification.

<http://www.picmg.org/>

## FCC and DOC Statement on Class B

This equipment has been tested and found to comply with the limits for a Class B digital device, pursuant to Part 15 of the FCC rules. These limits are designed to provide reasonable protection against harmful interference when the equipment is operated in a residential installation. This equipment generates, uses and can radiate radio frequency energy and, if not installed and used in accordance with the instruction manual, may cause harmful interference to radio communications. However, there is no guarantee that interference will not occur in a particular installation. If this equipment does cause harmful interference to radio or television reception, which can be determined by turning the equipment off and on, the user is encouraged to try to correct the interference by one or more of the following measures:

- Reorient or relocate the receiving antenna.
- Increase the separation between the equipment and the receiver.
- Connect the equipment into an outlet on a circuit different from that to which the receiver is connected.
- Consult the dealer or an experienced radio TV technician for help.

### Notice:

1. The changes or modifications not expressly approved by the party responsible for compliance could void the user's authority to operate the equipment.
2. Shielded interface cables must be used in order to comply with the emission limits.

## Table of Contents

Copyright.....	2
Trademarks .....	2
COM Express Specification Reference.....	2
FCC and DOC Statement on Class B.....	2
Warranty.....	4
Static Electricity Precautions.....	4
Safety Measures .....	4
About the Package.....	5
Optional Items.....	5
Before Using the System Board.....	5
Chapter 1 - Introduction .....	6
Specifications .....	6
Features.....	7
Chapter 2 - Concept.....	8
COM Express Module Standards.....	8
Specification Comparison Table .....	9
Chapter 3 - Hardware Installation.....	10
Board Layout.....	10
Block Diagram.....	10
System Memory.....	11
Connectors.....	12
COM Express Connector.....	12
COM Express Connector Signal Discription .....	15
Cooling Option.....	21
Heat Sink .....	21
Installing AL9A8 onto a Carrier Board.....	21
Installing the COM Express Debug Card.....	22

Chapter 4 - BIOS Setup.....	25
Overview.....	25
AMI BIOS Setup Utility.....	26
Main .....	26
Advanced .....	26
Security.....	33
Boot.....	34
Save & Exit .....	35
Updating the BIOS .....	36
Notice: BIOS SPI ROM .....	36
Chapter 5 - Supported Software .....	37
Chapter 6 - GPIO Programming Code .....	44
Appendix A - Watchdog Sample Code.....	45
Appendix B - System Error Message.....	46
Appendix C - Troubleshooting .....	48

## Warranty

1. Warranty does not cover damages or failures that arised from misuse of the product, inability to use the product, unauthorized replacement or alteration of components and product specifications.
2. The warranty is void if the product has been subjected to physical abuse, improper installation, modification, accidents or unauthorized repair of the product.
3. Unless otherwise instructed in this user's manual, the user may not, under any circumstances, attempt to perform service, adjustments or repairs on the product, whether in or out of warranty. It must be returned to the purchase point, factory or authorized service agency for all such work.
4. We will not be liable for any indirect, special, incidental or consequential damages to the product that has been modified or altered.

## Static Electricity Precautions

It is quite easy to inadvertently damage your PC, system board, components or devices even before installing them in your system unit. Static electrical discharge can damage computer components without causing any signs of physical damage. You must take extra care in handling them to ensure against electrostatic build-up.

1. To prevent electrostatic build-up, leave the system board in its anti-static bag until you are ready to install it.
2. Wear an antistatic wrist strap.
3. Do all preparation work on a static-free surface.
4. Hold the device only by its edges. Be careful not to touch any of the components, contacts or connections.
5. Avoid touching the pins or contacts on all modules and connectors. Hold modules or connectors by their ends.



### Important:

Electrostatic discharge (ESD) can damage your processor, disk drive and other components. Perform the upgrade instruction procedures described at an ESD workstation only. If such a station is not available, you can provide some ESD protection by wearing an antistatic wrist strap and attaching it to a metal part of the system chassis. If a wrist strap is unavailable, establish and maintain contact with the system chassis throughout any procedures requiring ESD protection.

## Safety Measures

To avoid damage to the system:

- Use the correct AC input voltage range.

To reduce the risk of electric shock:

- Unplug the power cord before removing the system chassis cover for installation or servicing. After installation or servicing, cover the system chassis before plugging the power cord.

## About the Package

The package contains the following items. If any of these items are missing or damaged, please contact your dealer or sales representative for assistance.

- 1 AL9A8 board

## Optional Items

The board and accessories in the package may not come similar to the information listed above. This may differ in accordance with the sales region or models in which it was sold. For more information about the standard package in your region, please contact your dealer or sales representative.

## Before Using the System Board

Before using the system board, prepare basic system components.

If you are installing the system board in a new system, you will need at least the following internal components.

- Storage devices such as hard disk drive, etc.

You will also need external system peripherals you intend to use which will normally include at least a keyboard, a mouse and a video display monitor.

## Chapter 1 - Introduction

### Specifications

<b>SYSTEM</b>	<b>Processor</b>	Intel® Atom™ Processor E3900 Series, BGA 1296 Intel® Atom™, Dual/Quad Core, 2M Cache, 1.8~2.0GHz, 5.5~12W Intel® Pentium® Processor N4200, Quad Core, 2M Cache, 2.5GHz, 6W Intel® Celeron® Processor N3350, Dual Core, 2M Cache, 2.2GHz, 6W	
	<b>Memory</b>	4GB/8GB Memory Down Dual Channel LPDDR4 2400MHz	
	<b>BIOS</b>	AMI SPI 128Mbit (supports UEFI boot only)	
<b>GRAPHICS</b>	<b>Controller</b>	Intel® HD Graphics	
	<b>Feature</b>	OpenGL 5.0, DirectX 12, OpenCL 2.1 HW Decode: AVC/H.264, MPEG2, VC1, WMV9, JPEG/MJPEG, HEVC/H.265, VP8, VP9, MVC HW Encode: AVC/H.264, JPEG/MJPEG, HEVC/H.265, VP8, VP9, MVC	
	<b>Display</b>	1 x DDI (HDMI/DP++) 1 x LVDS/eDP LVDS: single channel 24-bit, resolution up to 1366x768 @ 60Hz HDMI: resolution up to 4096x2160 @ 30 Hz DP++: resolution up to 4096x2304 @ 60Hz / 3840x2160 @ 60Hz eDP: resolution up to 4096x2304 @ 60Hz	
	<b>Dual Display</b>	DDI + LVDS	DDI + eDP
<b>EXPANSION</b>	<b>Interface</b>	4 x PCIe x1 (Gen 2) 1 x SDIO (available upon request) 1 x LPC 1 x I <sup>2</sup> C 1 x SMBus 1 x SPI 2 x UART (TX/RX)	
<b>AUDIO</b>	<b>Interface</b>	HD Audio	
<b>ETHERNET</b>	<b>Controller</b>	1 x Intel® I210AT (10/100/1000Mbps) (0°C to 60°C) 1 x Intel® I210IT (10/100/1000Mbps) (-40°C to 85°C)	
<b>I/O</b>	<b>USB</b>	2 x USB 3.0 8 x USB 2.0	
	<b>SATA</b>	2 x SATA 3.0 (up to 6Gb/s)	
	<b>eMMC</b>	1 x eMMC up to 128 GByte	
	<b>GPIO</b>	1 x 6-bit GPIO	
<b>WATCHDOG TIMER</b>	<b>Output &amp; Interval</b>	System Reset, Programmable via Software from 1 to 255 Seconds	
<b>POWER</b>	<b>Type</b>	4.75V~20V, 5VSB, VCC_RTC (ATX mode)	4.75V~20V, VCC_RTC (AT mode)
	<b>Consumption</b>	Typical: E3940: 12V @ 0.34A (4.08W) Max.: E3940:12V @ 1.62A (19.44W)	
<b>OS SUPPORT (UEFI ONLY)</b>		Windows 10 IoT Enterprise 64-bit	Linux
<b>ENVIRONMENT</b>	<b>Temperature</b>	Operating: -5 to 65°C -40 to 85°C	Storage: -40 to 85°C
	<b>Humidity</b>	Operating: 5 to 90% RH	Storage: 5 to 90% RH
	<b>MTBF</b>	TBD	
<b>MECHANICAL</b>	<b>Dimensions</b>	COM Express® Mini	84mm (3.30") x 55mm (2.16")
	<b>Compliance</b>	PICMG COM Express® R2.1, Type 10	
<b>CERTIFICATIONS</b>	<b>Certifications</b>	CE, FCC, RoHS, UKCA	

## Chapter 2 - Concept

### COM Express Module Standards

The figure below shows the dimensions of the different types of COM Express modules.

AL9A8 is a COM Express Mini. The dimension is 84mm x 55mm.

- Common for all Form Factors
- Extended only
- Basic only
- Compact only
- Compact and Basic only
- Mini only

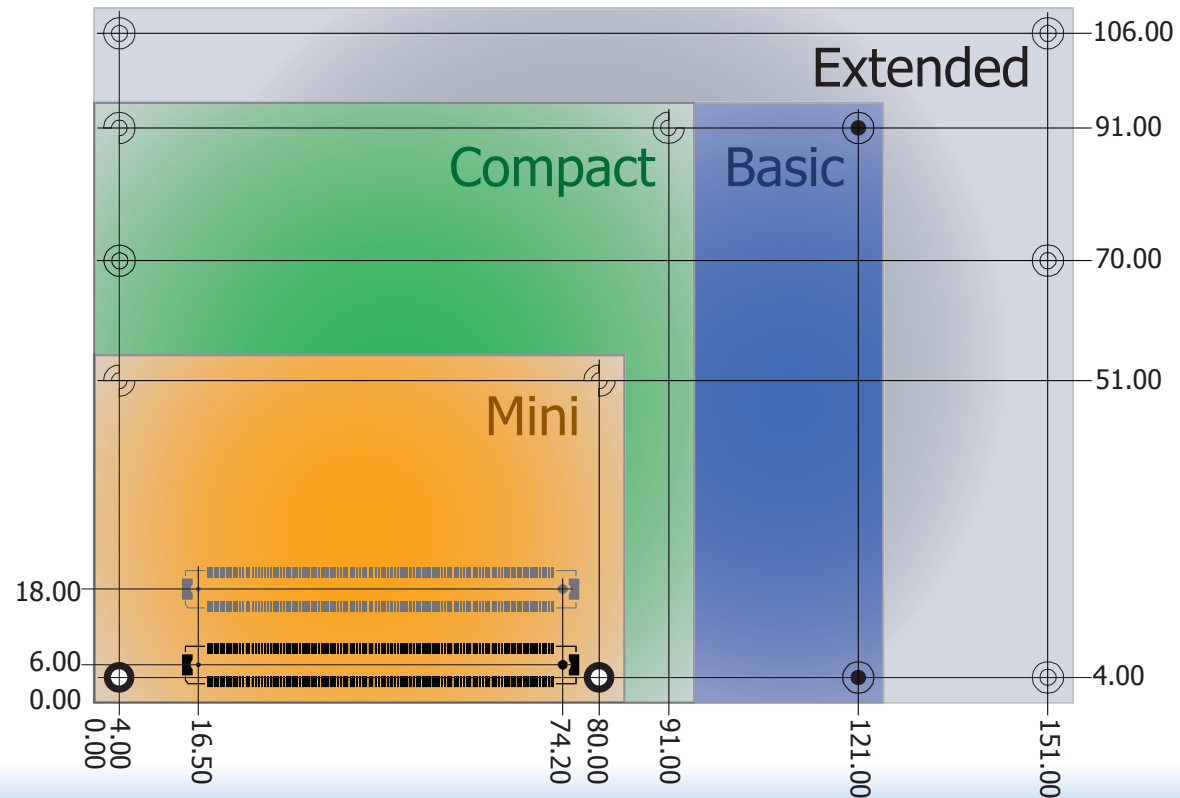

## Specification Comparison Table

The table below shows the COM Express standard specifications and the corresponding specifications supported on the AL9A8 module.

Connector	Feature	COM Express Module Base Specification Type 10 (Single Connector) Min / Max	DFI AL9A8 Type 10
<b>System I/O</b>			
A-B	PCI Express Lanes 0 - 5	1 / 4	4
A-B	LVDS Channel A	0 / 1	1
A-B	LVDS Channel B	NA	NA
A-B	eDP on LVDS CH A pins	0 / 1	1(option)
A-B	VGA Port	NA	NA
A-B	TV-Out	NA	NA
A-B	DDI 0	0 / 1	1
A-B <sup>5</sup>	Serial Ports 1 - 2	0 / 2	2
A-B	CAN interface on SER1	0 / 1	1
A-B	SATA / SAS Ports	1 / 2	2
A-B	AC'97 / HDA Digital Interface	0 / 1	1
A-B	USB 2.0 Ports	4 / 8	8
A-B	USB Client	0 / 1	0
A-B	USB 3.0 Ports	0 / 2	2
A-B	LAN Port 0	1 / 1	1
A-B	Express Card Support	0 / 2	2
A-B	LPC Bus	1 / 1	1
A-B	SPI	1 / 2	1
<b>System Management</b>			
A-B <sup>6</sup>	SDIO (muxed on GPIO)	0 / 1	1(option)
A-B <sup>6</sup>	General Purpose I/O	8 / 8	8
A-B	SMBus	1 / 1	1
A-B	I2C	1 / 1	1
A-B	Watchdog Timer	0 / 1	1
A-B	Speaker Out	1 / 1	1
A-B	External BIOS ROM Support	0 / 2	1
A-B	Reset Functions	1 / 1	1



### Note:

- 5 Indicates 12V-tolerant features on former VCC\_12V signals.
- 6 Cells in the connected columns spanning rows provide a rough approximation of features sharing connector pins.

Connector	Feature	COM Express Module Base Specification Type 10 (Single Connector) Min / Max	DFI AL9A8 Type 10
<b>Power Management</b>			
A-B	Thermal Protection	0 / 1	1
A-B	Battery Low Alarm	0 / 1	1
A-B	Suspend/Wake Signals	0 / 3	3
A-B	Power Button Support	1 / 1	1
A-B	Power Good	1 / 1	1
A-B	VCC_5V_SBY Contacts	4 / 4	4
A-B <sup>5</sup>	Sleep Input	0 / 1	1
A-B <sup>5</sup>	Lid Input	0 / 1	1
A-B <sup>5</sup>	Fan Control Signals	0 / 2	2
A-B	Trusted Platform Modules	0 / 1	0
<b>Power</b>			
A-B	VCC_12V Contacts	12 / 12	12

Module Pin-out - Required and Optional Features C-D Connector. PICMG® COM Express® Revision 2.1

Connector	Feature	COM Express Module Base Specification Type 10 (Single Connector) Min / Max	DFI AL9A8 Type 10
<b>System I/O</b>			
C-D	PCI Express Lanes 16 - 31	NA	NA
C-D	PCI Express Graphics (PEG)	NA	NA
C-D <sup>6</sup>	Muxed SDVO Channels 1 - 2	NA	NA
C-D <sup>6</sup>	PCI Express Lanes 6 - 15	NA	NA
C-D <sup>6</sup>	PCI Bus - 32 Bit	NA	NA
C-D <sup>6</sup>	PATA Port	NA	NA
C-D <sup>6</sup>	LAN Ports 1 - 2	NA	NA
C-D <sup>6</sup>	DDIs 1 - 3	NA	NA
C-D <sup>6</sup>	USB 3.0 Ports	NA	NA
<b>Power</b>			
C-D	VCC_12V Contacts	NA	NA



# Chapter 3 - Hardware Installation

## Board Layout

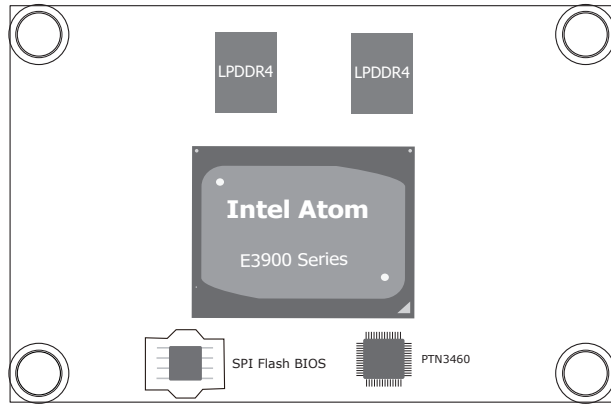

TOP

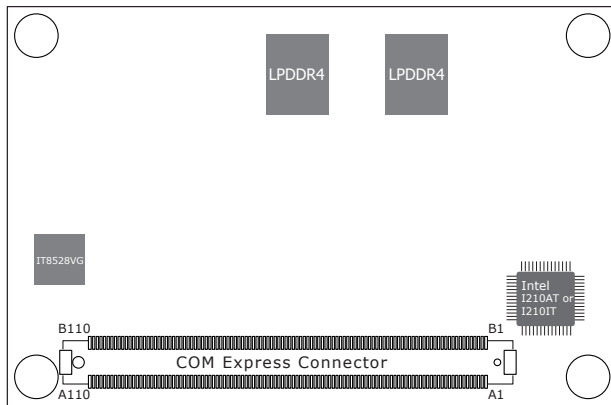

BOTTOM

## Block Diagram

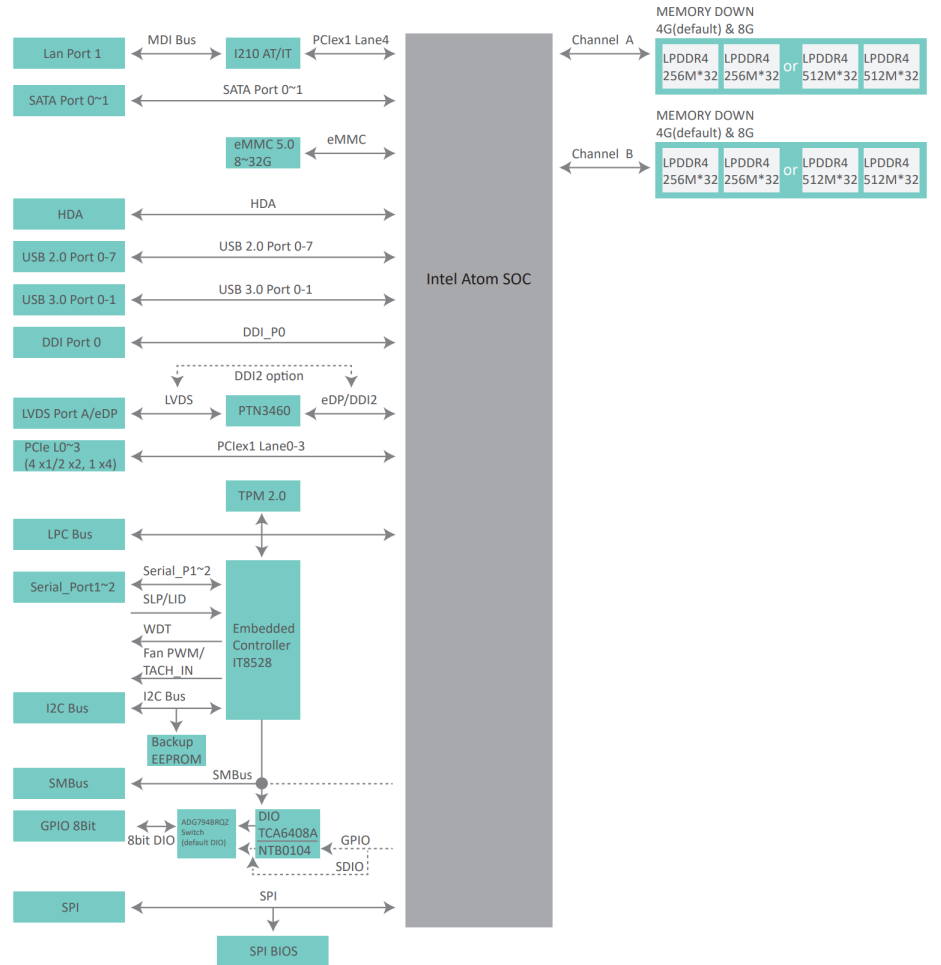

## Connectors

### COM Express Connector

The COM Express connector is used to interface the AL9A8 COM Express board to a carrier board. Connect the COM Express connector (located on the solder side of the board) to the COM Express connector on the carrier board.

Refer to the "Installing AL9A8 onto a Carrier Board" section for more information.

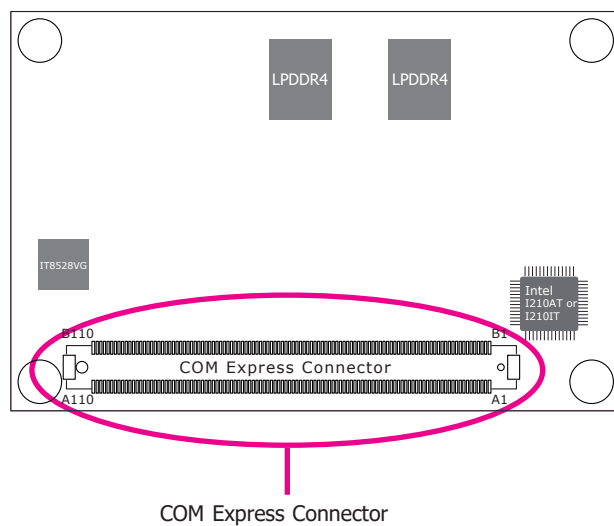

Refer to the following pages for the pin functions of the connector.

## COM Express Connector

Row A		Row B	
A1	GND	B1	GND
A2	GBE_MDI3-	B2	GBE_ACT# / 3.3V Suspend
A3	GBE_MDI3+	B3	LPC_FRAME#
A4	GBE_LED_100- / 3.3V Suspend	B4	LPC_AD0
A5	GBE_LED_1000- / 3.3V Suspend	B5	LPC_AD1
A6	GBE_MDI2-	B6	LPC_AD2
A7	GBE_MDI2+	B7	LPC_AD3
A8	GBE_LED_LINK- / 3.3V Suspend	B8	LPC_DRQ0#
A9	GBE_MDI1-	B9	LPC_DRQ1#
A10	GBE_MDI1+	B10	LPC_CLK
A11	GND	B11	GND
A12	GBE_MDI0-	B12	PWRBTN# / 3.3V Suspend
A13	GBE_MDI0+	B13	SMB_CK / 3.3V Suspend
A14	NA	B14	SMB_DAT / 3.3V Suspend
A15	SUS_S3#	B15	SMB_ALERT# / 3.3V Suspend
A16	SATA0_TX+	B16	SATA1_TX+
A17	SATA0_TX-	B17	SATA1_TX-
A18	SUS_S4#	B18	SUS_STAT#
A19	SATA0_RX+	B19	SATA1_RX+
A20	SATA0_RX-	B20	SATA1_RX-
A21	GND	B21	GND
A22	USB_SSRX0-	B22	USB_SSTX0-
A23	USB_SSRX0+	B23	USB_SSTX0+
A24	SUS_S5#	B24	PWR_OK
A25	USB_SSRX1-	B25	USB_SSTX1-
A26	USB_SSRX1+	B26	USB_SSTX1+
A27	BATLOW# / Pull up 4.7kohm to 3.3V Suspend	B27	WDT / Pull up 10k ohm to 3.3V
A28	ATA_ACT# / Pull up 10kohm to 3.3V Suspend	B28	NA
A29	AC/HDA_SYNC / 3.3V Suspend	B29	NA
A30	AC/HDA_RST# / 3.3V Suspend	B30	AC/HDA_SDINO

Row A		Row B	
A31	GND	B31	GND
A32	AC/HDA_BITCLK / 3.3V Suspend	B32	SPKR
A33	AC/HDA_SDOUT / 3.3V Suspend	B33	I2C_CK / 3.3V Suspend
A34	BIOS_DIS0#	B34	I2C_DAT / 3.3V Suspend
A35	THRMTRIP# / 3.3V Suspend	B35	THRM#
A36	USB6-	B36	USB7-
A37	USB6+	B37	USB7+
A38	USB_6_7_OC# / 3.3V Suspend	B38	USB_4_5_OC# / 3.3V Suspend
A39	USB4-	B39	USB5-
A40	USB4+	B40	USB5+
A41	GND	B41	GND
A42	USB2-	B42	USB3-
A43	USB2+	B43	USB3+
A44	USB_2_3_OC# / 3.3V Suspend	B44	USB_0_1_OC# / 3.3V Suspend
A45	USB0-	B45	USB1-
A46	USB0+	B46	USB1+
A47	VCC_RTC	B47	EXCD1_PERST#
A48	EXCD0_PERST#	B48	EXCD1_CPPE#
A49	EXCD0_CPPE#	B49	SYS_RESET# / Pull up to 3.3V Suspend
A50	LPC_SERIRQ	B50	CB_RESET# / Pull up to 3.3V Suspend
A51	GND	B51	GND
A52	NC (Option I2C_CLK_EC)	B52	NC (Option COMe_GPI5)
A53	NC (Option I2C_DATA_EC)	B53	NC (Option COMe_GPO5)
A54	GPI0	B54	GPO1
A55	NC (Option COMe_GPI4)	B55	NC (Option COMe_GPI6)
A56	NC (Option COMe_GPO4)	B56	NC (Option COMe_GPO6)
A57	GND	B57	GPO2
A58	PCIE_TX3+	B58	PCIE_RX3+
A59	PCIE_TX3-	B59	PCIE_RX3-
A60	GND	B60	GND

Row A		Row B	
A61	PCIE_TX2+	B61	PCIE_RX2+
A62	PCIE_TX2-	B62	PCIE_RX2-
A63	GPI1	B63	GPO3
A64	PCIE_TX1+	B64	PCIE_RX1+
A65	PCIE_TX1-	B65	PCIE_RX1-
A66	GND	B66	WAKE0#
A67	GPI2	B67	WAKE1#
A68	PCIE_TX0+	B68	PCIE_RX0+
A69	PCIE_TX0-	B69	PCIE_RX0-
A70	GND	B70	GND
A71	LVDS_A0+ / eDP_TX2+ (option)	B71	DDIO_PAIR0+
A72	LVDS_A0- / eDP_TX2- (option)	B72	DDIO_PAIR0-
A73	LVDS_A1+ / eDP_TX1+ (option)	B73	DDIO_PAIR1+
A74	LVDS_A1- / eDP_TX1- (option)	B74	DDIO_PAIR1-
A75	LVDS_A2+ / eDP_TX0+ (option)	B75	DDIO_PAIR2+
A76	LVDS_A2- / eDP_TX0- (option)	B76	DDIO_PAIR2-
A77	LVDS_VDD_EN / eDP_VDD_EN (option)	B77	NA
A78	LVDS_A3+	B78	NA
A79	LVDS_A3-	B79	LVDS_BKLT_EN / eDP_BKLT_EN (option)
A80	GND	B80	GND
A81	LVDS_A_CK+ / eDP_TX3+ (option)	B81	DDIO_PAIR3+
A82	LVDS_A_CK- / eDP_TX3- (option)	B82	DDIO_PAIR3-
A83	LVDS_I2C_CK / eDP_AUX+ (option)	B83	LVDS_BKLT_CTRL / eDP_BKLT_CTRL (option)
A84	LVDS_I2C_DAT / eDP_AUX- (option)	B84	VCC_5V_SBY
A85	GPI3	B85	VCC_5V_SBY
A86	NA	B86	VCC_5V_SBY
A87	eDP_HPD	B87	VCC_5V_SBY
A88	PCIE0_CLK_REF+	B88	BIOS_DIS1#
A89	PCIE0_CLK_REF-	B89	DD0_HPD
A90	GND	B90	GND

Row A		Row B	
A91	SPI_POWER / 3.3V Suspend	B91	NA
A92	SPI_MISO / 3.3V Suspend	B92	NA
A93	GPO0	B93	NA
A94	SPI_CLK / 3.3V Suspend	B94	NA
A95	SPI_MOSI / 3.3V Suspend	B95	DDIO_DDC_AUX_SEL
A96	NA	B96	NC / USB_HOST_PRSNT 3.3V (option)
A97	TYPE10# / Pull down 47k ohm to GND	B97	SPI_CS# / 3.3V Suspend
A98	SER0_TX	B98	DDIO_CTRLCLK_AUX+
A99	SER0_RX	B99	DDIO_CTRLDATA_AUX-
A100	GND	B100	GND
A101	SER1_TX	B101	FAN_PWMOUT
A102	SER1_RX	B102	FAN_TACHIN
A103	LID#	B103	SLEEP#
A104	VCC	B104	VCC
A105	VCC	B105	VCC
A106	VCC	B106	VCC
A107	VCC	B107	VCC
A108	VCC	B108	VCC
A109	VCC	B109	VCC
A110	GND	B110	GND

## COM Express Connector Signal Description

Pin Types  
 I Input to the Module  
 O Output from the Module  
 I/O Bi-directional input / output signal  
 OD Open drain output

### AC97/HDA Signals Descriptions

Signal	Pin#	Pin Type	Pwr Rail /Tolerance	AL9A8	Carrier Board	Description
AC/HDA_RST#	A30	O CMOS	3.3V Suspend/3.3V		Connect to CODEC pin 11 RESET#	Reset output to CODEC, active low.
AC/HDA_SYNC	A29	O CMOS	3.3V/3.3V		Connect to CODEC pin 10 SYNC	Sample-synchronization signal to the CODEC(s).
AC/HDA_BITCLK	A32	I/O CMOS	3.3V/3.3V		Connect to CODEC pin 6 BIT_CLK	Serial data clock generated by the external CODEC(s).
AC/HDA_SDOOUT	A33	O CMOS	3.3V/3.3V		Connect to CODEC pin 5 SDATA_OUT	Serial TDM data output to the CODEC.
AC/HDA_SDIN2	B28	I/O CMOS	3.3V Suspend/3.3V		Connect 33 $\Omega$ in series to CODEC2 pin 8 SDATA_IN	Serial TDM data inputs from up to 3 CODECs.
AC/HDA_SDIN1	B29	I/O CMOS	3.3V Suspend/3.3V		Connect 33 $\Omega$ in series to CODEC1 pin 8 SDATA_IN	
AC/HDA_SDIN0	B30	I/O CMOS	3.3V Suspend/3.3V		Connect 33 $\Omega$ in series to CODEC0 pin 8 SDATA_IN	

### Gigabit Ethernet Signals Descriptions

Signal	Pin#	Pin Type	Pwr Rail /Tolerance	AL9A8	Carrier Board	Description
GBE0_MDI0+	A13	I/O Analog	3.3V max Suspend		Connect to Magnetics Module MDI0+/-	Gigabit Ethernet Controller 0: Media Dependent Interface Differential Pairs 0,1,2,3. The MDI can operate in 1000, 100 and 10 Mbit / sec modes. Some pairs are unused in some modes, per the following: 1000BASE-T    100BASE-TX    10BASE-T MDI[0]+/-    B1_DA+/-    TX+/-    TX+/- MDI[1]+/-    B1_DB+/-    RX+/-    RX+/- MDI[2]+/-    B1_DC+/- MDI[3]+/-    B1_DD+/-
GBE0_MDI0-	A12	I/O Analog	3.3V max Suspend		Connect to Magnetics Module MDI0+/-	
GBE0_MDI1+	A10	I/O Analog	3.3V max Suspend		Connect to Magnetics Module MDI1+/-	
GBE0_MDI1-	A9	I/O Analog	3.3V max Suspend		Connect to Magnetics Module MDI1+/-	
GBE0_MDI2+	A7	I/O Analog	3.3V max Suspend		Connect to Magnetics Module MDI2+/-	
GBE0_MDI2-	A6	I/O Analog	3.3V max Suspend		Connect to Magnetics Module MDI2+/-	
GBE0_MDI3+	A3	I/O Analog	3.3V max Suspend	Connect to Magnetics Module MDI3+/-		
GBE0_MDI3-	A2	I/O Analog	3.3V max Suspend			
GBE0_ACT#	B2	OD CMOS	3.3V Suspend/3.3V		Connect to LED and <b>recommend</b> current limit resistor 150 $\Omega$ to 3.3VSB	Gigabit Ethernet Controller 0 activity indicator, active low.
GBE0_LINK#	A8	OD CMOS	3.3V Suspend/3.3V		NC	Gigabit Ethernet Controller 0 link indicator, active low.
GBE0_LINK100#	A4	OD CMOS	3.3V Suspend/3.3V		Connect to LED and <b>recommend</b> current limit resistor 150 $\Omega$ to 3.3VSB	Gigabit Ethernet Controller 0 100 Mbit / sec link indicator, active low.
GBE0_LINK1000#	A5	OD CMOS	3.3V Suspend/3.3V		Connect to LED and <b>recommend</b> current limit resistor 150 $\Omega$ to 3.3VSB	Gigabit Ethernet Controller 0 1000 Mbit / sec link indicator, active low.

### SATA Signals Descriptions

Signal	Pin#	Pin Type	Pwr Rail /Tolerance	AL9A8	Carrier Board	Description
SATA0_TX+	A16	O SATA	AC coupled on Module	AC Coupling capacitor	Connect to SATA0 Conn TX pin	Serial ATA or SAS Channel 0 transmit differential pair.
SATA0_TX-	A17	O SATA	AC coupled on Module	AC Coupling capacitor		
SATA0_RX+	A19	I SATA	AC coupled on Module	AC Coupling capacitor	Connect to SATA0 Conn RX pin	Serial ATA or SAS Channel 0 receive differential pair.
SATA0_RX-	A20	I SATA	AC coupled on Module	AC Coupling capacitor		
SATA1_TX+	B16	O SATA	AC coupled on Module	AC Coupling capacitor	Connect to SATA1 Conn TX pin	Serial ATA or SAS Channel 1 transmit differential pair.
SATA1_TX-	B17	O SATA	AC coupled on Module	AC Coupling capacitor		
SATA1_RX+	B19	I SATA	AC coupled on Module	AC Coupling capacitor	Connect to SATA1 Conn RX pin	Serial ATA or SAS Channel 1 receive differential pair.
SATA1_RX-	B20	I SATA	AC coupled on Module	AC Coupling capacitor		
ATA_ACT#	A28	I/O CMOS	3.3V / 3.3V	PU 4.7K to 3.3V Suspend	Connect to LED and <b>recommend</b> current limit resistor 220 $\Omega$ to 3.3V	ATA (parallel and serial) or SAS activity indicator, active low.

### PCI Express Lanes Signals Descriptions

Signal	Pin#	Pin Type	Pwr Rail /Tolerance	AL9A8	Carrier Board	Description
PCIE_TX0+	A68	O PCIE	AC coupled on Module	AC Coupling capacitor	Connect to PCIE device or slot	PCI Express Differential Transmit Pairs 0
PCIE_TX0-	A69			AC Coupling capacitor		
PCIE_RX0+	B68	I PCIE	AC coupled off Module		<b>Device</b> - Connect AC Coupling cap 0.1uF <b>Slot</b> - Connect to PCIE Conn pin	PCI Express Differential Receive Pairs 0
PCIE_RX0-	B69					
PCIE_TX1+	A64	O PCIE	AC coupled on Module	AC Coupling capacitor	Connect to PCIE device or slot	PCI Express Differential Transmit Pairs 1
PCIE_TX1-	A65			AC Coupling capacitor		
PCIE_RX1+	B64	I PCIE	AC coupled off Module		<b>Device</b> - Connect AC Coupling cap 0.1uF <b>Slot</b> - Connect to PCIE Conn pin	PCI Express Differential Receive Pairs 1
PCIE_RX1-	B65					
PCIE_TX2+	A61	O PCIE	AC coupled on Module	AC Coupling capacitor	Connect to PCIE device or slot	PCI Express Differential Transmit Pairs 2
PCIE_TX2-	A62			AC Coupling capacitor		
PCIE_RX2+	B61	I PCIE	AC coupled off Module		<b>Device</b> - Connect AC Coupling cap 0.1uF <b>Slot</b> - Connect to PCIE Conn pin	PCI Express Differential Receive Pairs 2
PCIE_RX2-	B62					
PCIE_TX3+	A58	O PCIE	AC coupled on Module	AC Coupling capacitor	Connect to PCIE device or slot	PCI Express Differential Transmit Pairs 3
PCIE_TX3-	A59			AC Coupling capacitor		
PCIE_RX3+	B58	I PCIE	AC coupled off Module		<b>Device</b> - Connect AC Coupling cap 0.1uF <b>Slot</b> - Connect to PCIE Conn pin	PCI Express Differential Receive Pairs 3
PCIE_RX3-	B59					
PCIE_CLK_REF+	A88	O PCIE	PCIE		Connect to PCIE device, <b>PCIE CLK Buffer</b> or slot	Reference clock output for all PCI Express and PCI Express Graphics lanes.
PCIE_CLK_REF-	A89					

### ExpressCard Signals Descriptions

Signal	Pin#	Pin Type	Pwr Rail /Tolerance	AL9A8	Carrier Board	Description
EXCD0_CPPE#	A49	I CMOS	3.3V /3.3V			PCI ExpressCard: PCI Express capable card request, active low, one per card
EXCD1_CPPE#	B48					
EXCD0_PERST#	A48	O CMOS	3.3V /3.3V			PCI ExpressCard: reset, active low, one per card
EXCD1_PERST#	B47					

### DDI Signals Descriptions

Signal	Pin#	Pin Type	Pwr Rail /Tolerance	AL9A8	Carrier Board	Description
DDIO_PAIR0+/DPO_LANE0+	B71	O PCIE	AC coupled off Module		Connect AC Coupling Capacitors 0.1uF to Device	DDI 0 Pair 0 differential pairs/Serial Digital Video B red output differential pair
DDIO_PAIR0-/DPO_LANE0-	B72			Connect AC Coupling Capacitors 0.1uF to Device		
DDIO_PAIR1+/DPO_LANE1+	B73	O PCIE	AC coupled off Module		Connect AC Coupling Capacitors 0.1uF to Device	DDI 0 Pair 1 differential pairs/Serial Digital Video B green output differential pair
DDIO_PAIR1-/DPO_LANE1-	B74			Connect AC Coupling Capacitors 0.1uF to Device		
DDIO_PAIR2+/DPO_LANE2+	B75	O PCIE	AC coupled off Module		Connect AC Coupling Capacitors 0.1uF to Device	DDI 0 Pair 2 differential pairs/Serial Digital Video B blue output differential pair
DDIO_PAIR2-/DPO_LANE2-	B76			Connect AC Coupling Capacitors 0.1uF to Device		
DDIO_PAIR3+/DPO_LANE3+	B81	O PCIE	AC coupled off Module		Connect AC Coupling Capacitors 0.1uF to Device	DDI 0 Pair 3 differential pairs/Serial Digital Video B clock output differential pair.
DDIO_PAIR3-/DPO_LANE3-	B82			Connect AC Coupling Capacitors 0.1uF to Device		
DDIO_PAIR4+	B77			NA	NA	NA for AL9A2
DDIO_PAIR4-	B78			NA	NA	NA for AL9A2
DDIO_PAIR5+	B91			NA	NA	NA for AL9A2
DDIO_PAIR5-	B92			NA	NA	NA for AL9A2
DDIO_PAIR6+	B93			NA	NA	NA for AL9A2
DDIO_PAIR6-	B94			NA	NA	NA for AL9A2
DDIO_CTRLCLK_AUX+/DPO_AUX+	B98	I/O PCIE	AC coupled on Module	PD 100K to GND <b>(S/W IC between Rpu/PCH)</b>	Connect to DP AUX+	DP AUX+ function if DDIO_DDC_AUX_SEL is no connect
		I/O OD CMOS	3.3V / 3.3V	PU 10K to 3.3V, PD 100K to GND <b>(S/W IC between Rpu/Rpd)</b>	Connect to HDMI/DVI I2C CTRLCLK	HDMI/DVI I2C CTRLCLK if DDIO_DDC_AUX_SEL is pulled high
DDIO_CTRLDATA_AUX-/DPO_AUX-	B99	I/O PCIE	AC coupled on Module	PU 100K to 3.3V	Connect to DP AUX-	DP AUX- function if DDIO_DDC_AUX_SEL is no connect
		I/O OD CMOS	3.3V / 3.3V	PU 2.2K to 3.3V/PU 100K to 3.3V	Connect to HDMI/DVI I2C CTRLDATA	HDMI/DVI I2C CTRLDATA if DDIO_DDC_AUX_SEL is pulled high
DDIO_HPD/DPO_HPD	B89	I CMOS	3.3V / 3.3V	PD 100K to GND	PD 1M and Connect to device Hot Plug Detect	DDI Hot-Plug Detect

DDIO_DDC_AUX_SEL	B95	I CMOS	3.3V / 3.3V	PD 1M to GND	PU 100k to 3.3V for DDC(HDMI/DVI)	<p>Selects the function of DDIO_CTRLCLK_AUX+ and DDIO_CTRLDATA_AUX-. This pin shall have a 1M pull-down to logic ground on the Module. If this input is floating the AUX pair is used for the DP AUX+/- signals. If pulled-high the AUX pair contains the CTRLCLK and CTRLDATA signals</p> <p>*****</p> <p>DDI[n]_DDC_AUX_SEL shall be pulled to 3.3V on the Carrier with a 100K Ohm resistor to configure the DDI[n]_AUX pair as the DDC channel.</p> <p>Carrier DDI[n]_DDC_AUX_SEL should be connected to pin 13 of the DisplayPort</p>
------------------	-----	--------	-------------	--------------	-----------------------------------	---

### USB Signals Descriptions

Signal	Pin#	Pin Type	Pwr Rail /Tolerance	AL9A8	Carrier Board	Description
USB0+	A46	I/O USB	3.3V Suspend/3.3V		Connect 90Ω @100MHz Common Choke in series and ESD suppressors to GND to USB connector	USB differential pairs 0
USB0-	A45					
USB1+	B46	I/O USB	3.3V Suspend/3.3V		Connect 90Ω @100MHz Common Choke in series and ESD suppressors to GND to USB connector	USB differential pairs 1
USB1-	B45					
USB2+	A43	I/O USB	3.3V Suspend/3.3V		Connect 90Ω @100MHz Common Choke in series and ESD suppressors to GND to USB connector	USB differential pairs 2
USB2-	A42					
USB3+	B43	I/O USB	3.3V Suspend/3.3V		Connect 90Ω @100MHz Common Choke in series and ESD suppressors to GND to USB connector	USB differential pairs 3
USB3-	B42					
USB4+	A40	I/O USB	3.3V Suspend/3.3V		Connect 90Ω @100MHz Common Choke in series and ESD suppressors to GND to USB connector	USB differential pairs 4
USB4-	A39					
USB5+	B40	I/O USB	3.3V Suspend/3.3V		Connect 90Ω @100MHz Common Choke in series and ESD suppressors to GND to USB connector	USB differential pairs 5
USB5-	B39					
USB6+	A37	I/O USB	3.3V Suspend/3.3V		Connect 90Ω @100MHz Common Choke in series and ESD suppressors to GND to USB connector	USB differential pairs 6
USB6-	A36					
USB7+	B37	I/O USB	3.3V Suspend/3.3V		Connect 90Ω @100MHz Common Choke in series and ESD suppressors to GND to USB connector	USB differential pairs 7
USB7-	B36					
USB_0_1_OC#	B44	I CMOS	3.3V Suspend/3.3V	PU 10k to 3.3VSB	Connect to Overcurrent of USB Power Switch	USB over-current sense, USB channels 0 and 1. A pull-up for this line shall be present on the Module. An open drain driver from a USB current monitor on the Carrier Board may drive this line low. Do not pull this line high on the Carrier Board.
USB_2_3_OC#	A44	I CMOS	3.3V Suspend/3.3V	PU 10k to 3.3VSB	Connect to Overcurrent of USB Power Switch	USB over-current sense, USB channels 2 and 3. A pull-up for this line shall be present on the Module. An open drain driver from a USB current monitor on the Carrier Board may drive this line low. Do not pull this line high on the Carrier Board.
USB_4_5_OC#	B38	I CMOS	3.3V Suspend/3.3V	PU 10k to 3.3VSB	Connect to Overcurrent of USB Power Switch	USB over-current sense, USB channels 4 and 5. A pull-up for this line shall be present on the Module. An open drain driver from a USB current monitor on the Carrier Board may drive this line low. Do not pull this line high on the Carrier Board.
USB_6_7_OC#	A38	I CMOS	3.3V Suspend/3.3V	PU 10k to 3.3VSB	Connect to Overcurrent of USB Power Switch	USB over-current sense, USB channels 6 and 7. A pull-up for this line shall be present on the Module. An open drain driver from a USB current monitor on the Carrier Board may drive this line low. Do not pull this line high on the Carrier Board.

USB_SSTX0+	B23	O PCIE	AC coupled on Module	AC Coupling capacitor	Connect 90Ω @100MHz Common Choke in series and ESD suppressors to GND to USB connector	Additional transmit signal differential pairs for the SuperSpeed USB data path.
USB_SSTX0-	B22			AC Coupling capacitor		
USB_SSRX0+	A23	I PCIE	AC coupled off Modul		Connect 90Ω @100MHz Common Choke in series and ESD suppressors to GND to USB connector	Additional receive signal differential pairs for the SuperSpeed USB data path.
USB_SSRX0-	A22					
USB_SSTX1+	B26	O PCIE	AC coupled on Module	AC Coupling capacitor	Connect 90Ω @100MHz Common Choke in series and ESD suppressors to GND to USB connector	Additional transmit signal differential pairs for the SuperSpeed USB data path.
USB_SSTX1-	B25			AC Coupling capacitor		
USB_SSRX1+	A26	I PCIE	AC coupled off Modul		Connect 90Ω @100MHz Common Choke in series and ESD suppressors to GND to USB connector	Additional receive signal differential pairs for the SuperSpeed USB data path.
USB_SSRX1-	A25					
USB_HOST_PRSNT	B96	I CMOS	3.3V Suspend/3.3V	NA	NA	Module USB client may detect the presence of a USB host. A high value (NA for AL9A2) indicates that a host is present.

### LVDS Signals Descriptions

Signal	Pin#	Pin Type	Pwr Rail /Tolerance	AL9A8	Carrier Board	Description
LVDS_A0+	A71	O LVDS	LVDS		Connect to LVDS connector	LVDS Channel A differential pairs
LVDS_A0-	A72					
LVDS_A1+	A73	O LVDS	LVDS		Connect to LVDS connector	
LVDS_A1-	A74					
LVDS_A2+	A75	O LVDS	LVDS		Connect to LVDS connector	
LVDS_A2-	A76					
LVDS_A3+	A78	O LVDS	LVDS		Connect to LVDS connector	
LVDS_A3-	A79					
LVDS_A_CK+	A81	O LVDS	LVDS		Connect to LVDS connector	LVDS Channel A differential clock
LVDS_A_CK-	A82					
LVDS_VDD_EN	A77	O CMOS	3.3V / 3.3V		Connect to enable control of LVDS panel power circuit	LVDS panel power enable
LVDS_BKLT_EN	B79	O CMOS	3.3V / 3.3V		Connect to enable control of LVDS panel backlight power circuit.	LVDS panel backlight enable
LVDS_BKLT_CTRL	B83	O CMOS	3.3V / 3.3V		Connect to brightness control of LVDS panel backlight power circuit.	LVDS panel backlight brightness control
LVDS_I2C_CK	A83	I/O OD CMOS	3.3V / 3.3V	PU 4.7K to 3.3V	Connect to DDC clock of LVDS panel	I2C clock output for LVDS display use
LVDS_I2C_DAT	A84	I/O OD CMOS	3.3V / 3.3V	PU 4.7K to 3.3V	Connect to DDC data of LVDS panel	I2C data line for LVDS display use

### LPC Signals Descriptions

Signal	Pin#	Pin Type	Pwr Rail /Tolerance	AL9A8	Carrier Board	Description
LPC_AD0	B4	I/O CMOS	3.3V / 3.3V		Connect to LPC device	LPC multiplexed address, command and data bus
LPC_AD1	B5					
LPC_AD2	B6					
LPC_AD3	B7					
LPC_FRAME#	B3	O CMOS	3.3V / 3.3V			LPC frame indicates the start of an LPC cycle
LPC_DRQ0#	B8	I CMOS	3.3V / 3.3V			LPC serial DMA request
LPC_DRQ1#	B9					
LPC_SERIRQ	A50	I/O CMOS	3.3V / 3.3V			LPC serial interrupt
LPC_CLK	B10	O CMOS	3.3V / 3.3V			LPC clock output - 33MHz nominal

### SPI Signals Descriptions

Signal	Pin#	Pin Type	Pwr Rail /Tolerance	AL9A8	Carrier Board	Description
SPI_CS#	B97	O CMOS	3.3V Suspend/3.3V	Connect a series resistor 33Ω	Connect a series resistor 33Ω to Carrier Board SPI Device CS# pin	Chip select for Carrier Board SPI - may be sourced from chipset SPI0 or SPI1
SPI_MISO	A92	I CMOS	3.3V Suspend/3.3V	Connect a series resistor 33Ω	Connect a series resistor 33Ω to Carrier Board SPI Device SO pin	Data in to Module from Carrier SPI
SPI_MOSI	A95	O CMOS	3.3V Suspend/3.3V	Connect a series resistor 33Ω	Connect a series resistor 33Ω to Carrier Board SPI Device SI pin	Data out from Module to Carrier SPI
SPI_CLK	A94	O CMOS	3.3V Suspend/3.3V	Connect a series resistor 33Ω	Connect a series resistor 33Ω to Carrier Board SPI Device SCK pin	Clock from Module to Carrier SPI
SPI_POWER	A91	O	3.3V Suspend/3.3V			Power supply for Carrier Board SPI – sourced from Module – nominally 3.3V. The Module shall provide a minimum of 100mA on SPI_POWER. Carriers shall use less than 100mA of SPI_POWER. SPI_POWER shall only be used to power SPI devices on the Carrier
BIOS_DIS0#	A34	I CMOS	NA	PU 10K to 3.3V		Selection straps to determine the BIOS boot device.
BIOS_DIS1#	B88					The Carrier should only float these or pull them low, please refer to COM Express Module Base Specification Revision 2.1 for strapping options of BIOS disable signals.



### Serial Interface Signals Descriptions

Signal	Pin#	Pin Type	Pwr Rail /Tolerance	AL9A8	Carrier Board	Description
SER0_TX	A98	O CMOS	5V / 12V(design 3.3v~5V tolerant)		PD 4.7K	General purpose serial port 0 transmitter
SER0_RX	A99	I CMOS	5V / 12V(design 3.3v~5V tolerant)			General purpose serial port 0 receiver
SER1_TX	A101	O CMOS	5V / 12V(design 3.3v~5V tolerant)		PD 4.7K	General purpose serial port 1 transmitter
SER1_RX	A102	I CMOS	5V / 12V(design 3.3v~5V tolerant)			General purpose serial port 1 receiver

### Miscellaneous Signal Descriptions

Signal	Pin#	Pin Type	Pwr Rail /Tolerance	AL9A8	Carrier Board	Description
I2C_CLK	B33	I/O OD CMOS	3.3V Suspend/3.3V	PU 2.2K to 3V3SB		General purpose I2C port clock output
I2C_DAT	B34	I/O OD CMOS	3.3V Suspend/3.3V	PU 2.2K to 3V3SB		General purpose I2C port data I/O line
SPKR	B32	O CMOS	3.3V / 3.3V	PU 10K to 3V3SB		Output for audio enunciator - the "speaker" in PC-AT systems. This port provides the PC beep signal and is mostly intended for debugging purposes.
WDT	B27	O CMOS	3.3V / 3.3V			Output indicating that a watchdog time-out event has occurred.
FAN_PWMOUT	B101	O OD CMOS	3.3V / 12V			Fan speed control. Uses the Pulse Width Modulation (PWM) technique to control the fan's RPM.
FAN_TACHIN	B102	I OD CMOS	3.3V / 12V			Fan tachometer input for a fan with a two pulse output.
TPM_PP	A96	I CMOS	3.3V / 3.3V	NC		Trusted Platform Module (TPM) Physical Presence pin. Active high. TPM chip has an internal pull down. This signal is used to indicate Physical Presence to the TPM. (NC for AL9A2)

### Power and System Management Signals Descriptions

Signal	Pin#	Pin Type	Pwr Rail /Tolerance	AL9A8	Carrier Board	Description
PWRBTN#	B12	I CMOS	3.3V Suspend/3.3V	PU 10K to 3V3SB		A falling edge creates a power button event. Power button events can be used to bring a system out of S5 soft off and other suspend states, as well as powering the system down.
SYS_RESET#	B49	I CMOS	3.3V Suspend/3.3V	PU 4.7K to 3V3SB		Reset button input. Active low request for Module to reset and reboot. May be falling edge sensitive. For situations when SYS_RESET# is not able to reestablish control of the system, PWR_OK or a power cycle may be used.
CB_RESET#	B50	O CMOS	3.3V Suspend/3.3V			Reset output from Module to Carrier Board. Active low. Issued by Module chipset and may result from a low SYS_RESET# input, a low PWR_OK input, a VCC_12V power input that falls below the minimum specification, a watchdog timeout, or may be initiated by the Module software.
PWR_OK	B24	I CMOS	3.3V / 3.3V	PU 10K to 3.3VSB		Power OK from main power supply. A high value indicates that the power is good. This signal can be used to hold off Module startup to allow Carrier based FPGAs or other configurable devices time to be programmed.
SUS_STAT#	B18	O CMOS	3.3V Suspend/3.3V			Indicates imminent suspend operation; used to notify LPC devices.
SUS_S3#	A15	O CMOS	3.3V Suspend/3.3V			Indicates system is in Suspend to RAM state. Active low output. An inverted copy of SUS_S3# on the Carrier Board may be used to enable the non-standby power on a typical ATX supply.
SUS_S4#	A18	O CMOS	3.3V Suspend/3.3V			Indicates system is in Suspend to Disk state. Active low output.
SUS_S5#	A24	O CMOS	3.3V Suspend/3.3V			Indicates system is in Soft Off state.
WAKE0#	B66	I CMOS	3.3V Suspend/3.3V	PU 1K to 3.3VSB		PCI Express wake up signal.
WAKE1#	B67	I CMOS	3.3V Suspend/3.3V	PU 1K to 3.3VSB		General purpose wake up signal. May be used to implement wake-up on PS2 keyboard or mouse activity.
BATLOW#	A27	I CMOS	3.3V Suspend/ 3.3V	PU 4.7K to 3.3VSB		Indicates that external battery is low. This port provides a battery-low signal to the Module for orderly transitioning to power saving or power cut-off ACPI modes.

LID#	A103	I OD CMOS	3.3V Suspend/12V	PU 47K to 3.3VSB	LID switch. Low active signal used by the ACPI operating system for a LID switch.
SLEEP#	B103	I OD CMOS	3.3V Suspend/12V	PU 10K to 3.3VSB	Sleep button. Low active signal used by the ACPI operating system to bring the system to sleep state or to wake it up again.
THRM#	B35	I CMOS	3.3V / 3.3V	PU 10K to 3.3VSB	Input from off-Module temp sensor indicating an over-temp situation.
THRMTRIP#	A35	O CMOS	3.3V / 3.3V	PU 10K to 3.3VSB	Active low output indicating that the CPU has entered thermal shutdown.
SMB CK	B13	I/O OD CMOS	3.3V Suspend/3.3V	PU 2.2K to 3.3VSB	System Management Bus bidirectional clock line.
SMB DAT	B14	I/O OD CMOS	3.3V Suspend/3.3V	PU 2.2K to 3.3VSB	System Management Bus bidirectional data line.
SMB_ALERT#	B15	I CMOS	3.3V Suspend/3.3V	PU 10K to 3.3VSB	System Management Bus Alert – active low input can be used to generate an SMI# (System Management Interrupt) or to wake the system.

### GPIO Signals Descriptions

Signal	Pin#	Pin Type	Pwr Rail /Tolerance	AL9A8	Carrier Board	Description
GPO0	A93	O CMOS	3.3V / 3.3V			General purpose output pins.
GPO1	B54					
GPO2	B57					
GPO3	B63					
GPI0	A54	I CMOS	PU 100K to 3V3	PU 47K to 3.3V		General purpose input pins.
GPI1	A63			PU 47K to 3.3V		
GPI2	A67			PU 47K to 3.3V		
GPI3	A85			PU 47K to 3.3V		

### Power and GND Signal Descriptions

Signal	Pin#	Pin Type	Pwr Rail /Tolerance	AL9A8	Carrier Board	Description
VCC_12V	A104~A109 B104~B109	Power	4.75V – 20.0V	4.75V – 20.0V		Primary power input: +12V nominal. All available VCC_12V pins on the connector(s) shall be used. The module supplies a wide range of power from 4.75V to 20.0V.
VCC_5V_SBY	B84~B87	Power	4.75V - 5.25V	4.75V - 5.25V		Standby power input: +5.0V nominal. If VCC5_SBY is used, all available VCC_5V_SBY pins on the connector(s) shall be used. Only used for standby and suspend functions. May be left unconnected if these functions are not used in the system design.
VCC_RTC	A47	Power	2.0V - 3.3V	2.0V - 3.3V		Real-time clock circuit-power input. Nominally +3.0V.
GND	A1, A11, A21, A31, A41, A51, A57, A60, A66, A70, A80, A90, A100, A110, B1, B11, B21, B31, B41, B51, B60, B70, B80, B90, B100, B110	Power				Ground - DC power and signal and AC signal return path. All available GND connector pins shall be used and tied to Carrier Board GND plane.

## Cooling Option

### Heat Sink

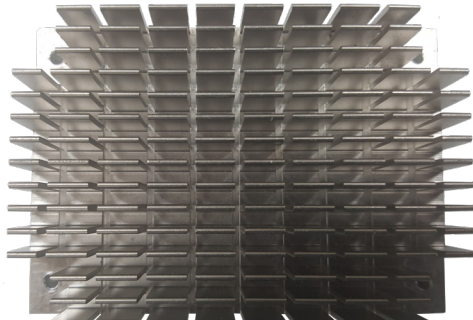

Top View of the Heat Sink

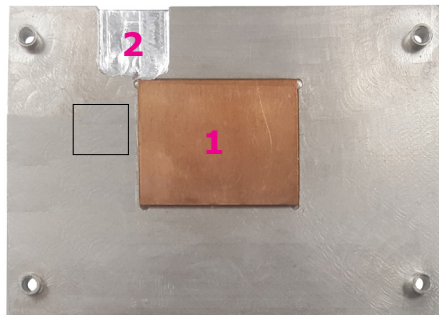

Bottom View of the Heat Sink

- "1" denotes the location of the thermal pad designed to contact the corresponding component that is on AL9A8. "2" denotes the location reserved for AL9A8 BIOS ROM socket.



#### Important:

Remove the plastic covering from the thermal pads prior to mounting the heat sink onto AL9A8.

## Installing AL9A8 onto a Carrier Board



#### Important:

The carrier board (COM100-B) used in this section is for reference purpose only and may not resemble your carrier board. These illustrations are mainly to guide you on how to install AL9A8 onto the carrier board of your choice.

1. Grasp AL9A8 by its edges and position it on top of the carrier board with its COM Express connector aligned with the COM Express connector on the carrier board. This will also help align the mountings holes of AL9A8 with the standoffs on the carrier board.

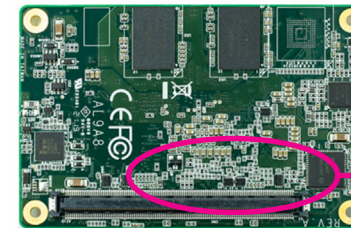

COM Express connector on AL9A8

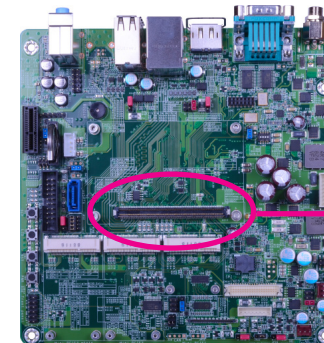

COM Express connector on the carrier board

2. Apply firm even pressure to the side with the COM Express connector first and push down the entire module. Be careful when pressing the module to avoid damaging it. You will hear a distinctive "click", indicating the module is correctly locked into position.

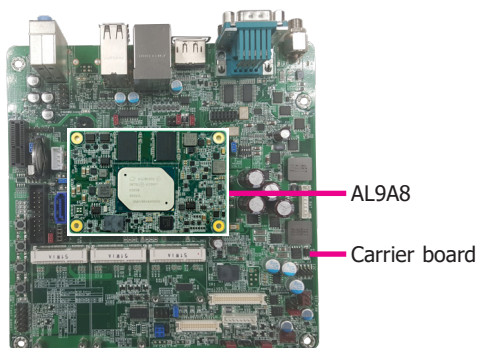

3. Align the mounting holes of the heatsink with the mounting holes of the module. Use the provided mounting screws to install the heat sink onto the module.

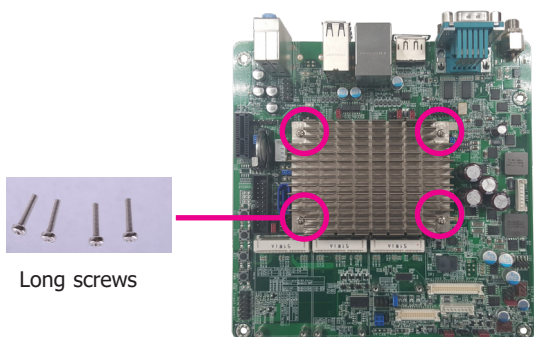

## Installing the COM Express Debug Card



### Note:

The system board used in the following illustrations may not resemble the actual board. These illustrations are for reference only.

1. COMe-LINK2 is the COM Express debug platform installed into COM Express Mini modules for the application of debugging and displaying signals and codes.

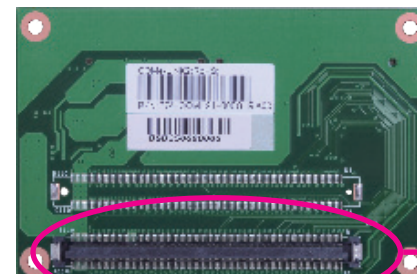
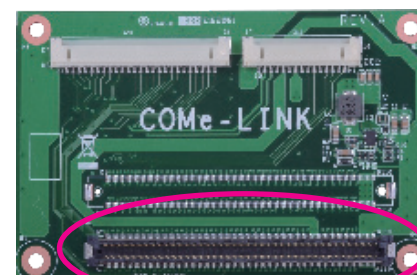

2. Connect the COMe-DEBUG card to COMe-LINK2 via a cable.

### COMe-DEBUG

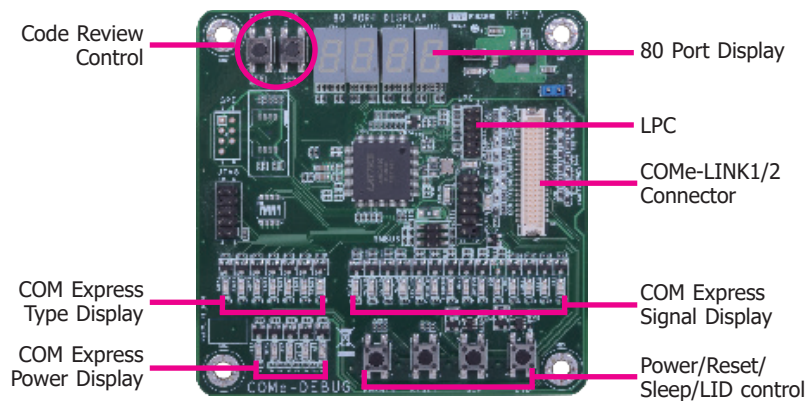

3. Fasten bolts with mounting screws through mounting holes to be fixed in place.

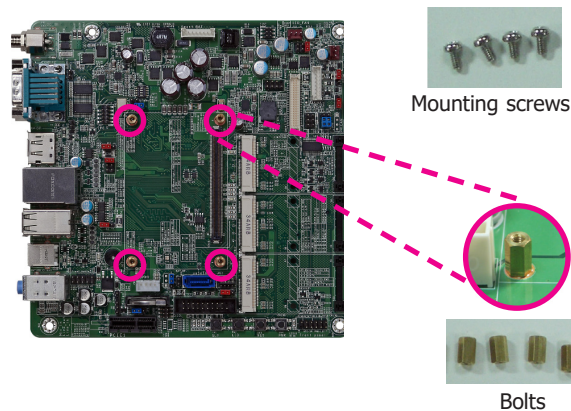

4. Use the provided bolts to fix the COMe-LINK2 debug card onto the carrier board.

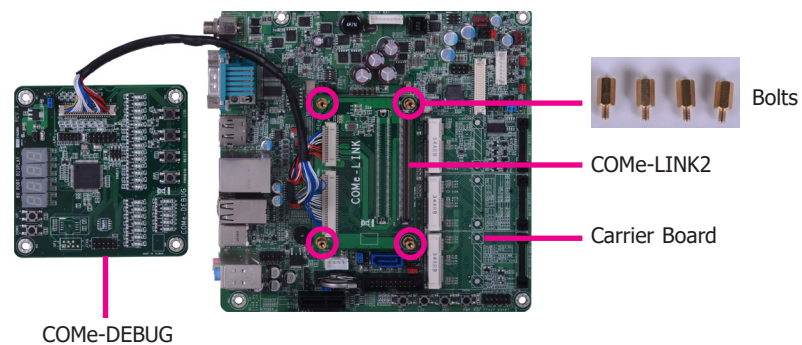
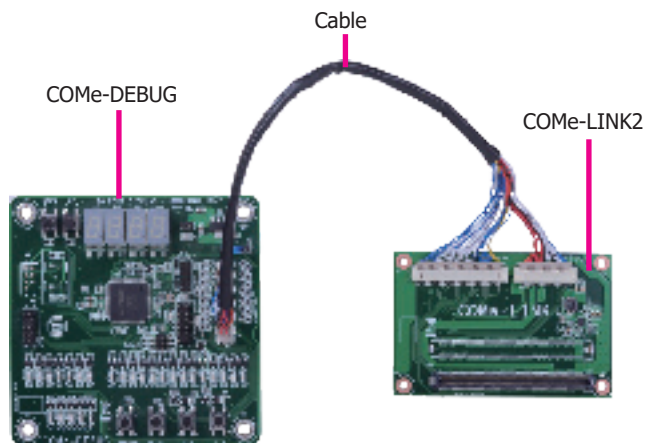



- Grasp the COM Express Mini module by its edges to press it down on the top of the COMe-LINK2 debug card.

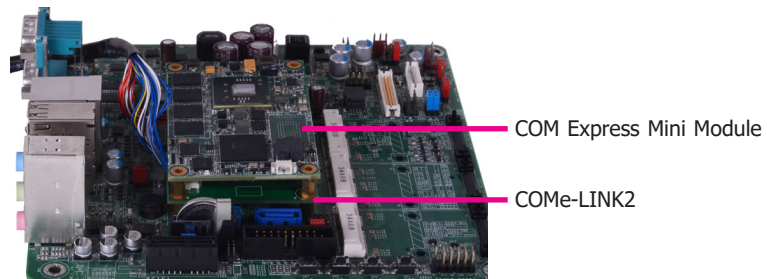

- Use the long mounting screws to secure the heat sink on the top of the COM Express Mini module and the COMe-LINK2 debug card and connect the cooling fan's cable to the fan connector on the COM Express Mini module. The photo below shows the locations of long mounting screws.

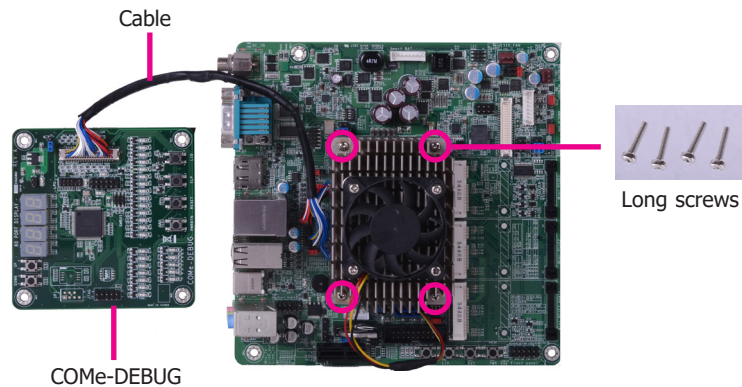

- Then, grasp the heat sink by its edges and position it down firmly on the top of the COM Express Mini module.

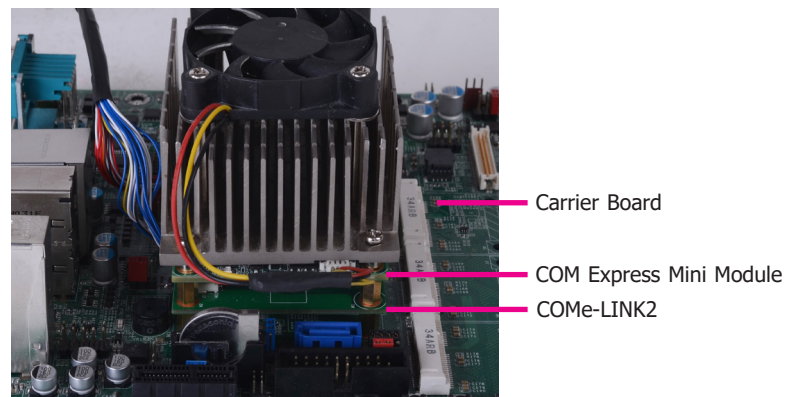
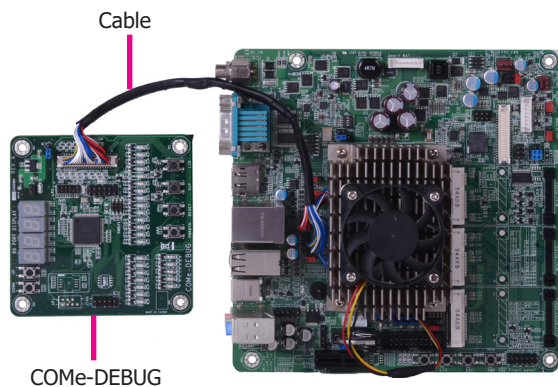

**Side View of the Module, Debug Card and Carrier Board**

## Chapter 4 - BIOS Setup

### Overview

The BIOS is a program that takes care of the basic level of communication between the CPU and peripherals. It contains codes for various advanced features found in this system board. The BIOS allows you to configure the system and save the configuration in a battery-backed CMOS so that the data retains even when the power is off. In general, the information stored in the CMOS RAM of the EEPROM will stay unchanged unless a configuration change has been made such as a hard drive replaced or a device added.

It is possible that the CMOS battery will fail causing CMOS data loss. If this happens, you need to install a new CMOS battery and reconfigure the BIOS settings.



**Note:**

The BIOS is constantly updated to improve the performance of the system board; therefore the BIOS screens in this chapter may not appear the same as the actual one. These screens are for reference purpose only.

### Default Configuration

Most of the configuration settings are either predefined according to the Load Optimal Defaults settings which are stored in the BIOS or are automatically detected and configured without requiring any actions. There are a few settings that you may need to change depending on your system configuration.

### Entering the BIOS Setup Utility

The BIOS Setup Utility can only be operated from the keyboard and all commands are keyboard commands. The commands are available at the right side of each setup screen.

The BIOS Setup Utility does not require an operating system to run. After you power up the system, the BIOS message appears on the screen and the memory count begins. After the memory test, the message "Press DEL to run setup" will appear on the screen. If the message disappears before you respond, restart the system or press the "Reset" button. You may also restart the system by pressing the <Ctrl> <Alt> and <Del> keys simultaneously.

### Legends

KEYs	Function
Right and Left Arrows	Moves the highlight left or right to select a menu.
Up and Down Arrows	Moves the highlight up or down between submenus or fields.
<Esc>	Exits to the BIOS setup utility
+ (plus key)	Scrolls forward through the values or options of the highlighted field.
- (minus key)	Scrolls backward through the values or options of the highlighted field.
<F1>	Displays general help
<F2>	Displays previous values
<F9>	Optimized defaults
<F10>	Saves and reset the setup program.
<Enter>	Press <Enter> to enter the highlighted submenu

### Scroll Bar

When a scroll bar appears to the right of the setup screen, it indicates that there are more available fields not shown on the screen. Use the up and down arrow keys to scroll through all the available fields.

### Submenu

When "►" appears on the left of a particular field, it indicates that a submenu which contains additional options are available for that field. To display the submenu, move the highlight to that field and press <Enter>.

## AMI BIOS Setup Utility

### Main

The Main menu is the first screen that you will see when you enter the BIOS Setup Utility.

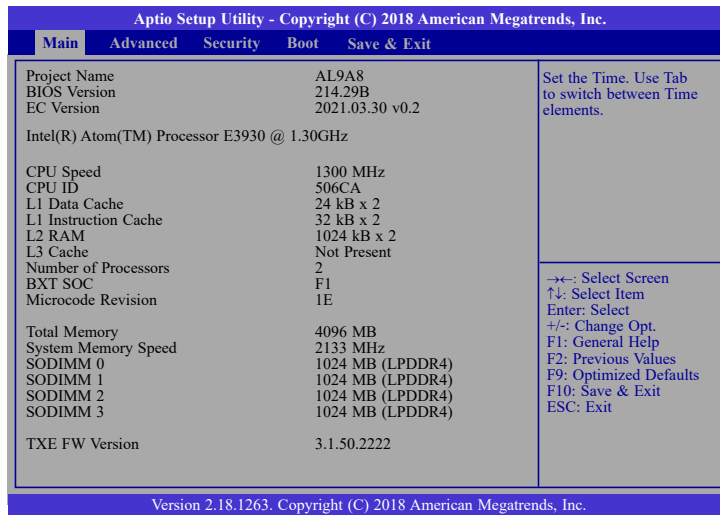

### System Time

The time format is <hour>, <minute>, <second>. The time is based on the 24-hour military-time clock. For example, 1 p.m. is 13:00:00. Hour displays hours from 00 to 23. Minute displays minutes from 00 to 59. Second displays seconds from 00 to 59.

### System Date

The date format is <day>, <month>, <date>, <year>. Day displays a day, from Sunday to Saturday. Month displays the month, from 01 to 12. Date displays the date, from 01 to 31. Year displays the year, from 2005 to 2099.

## Advanced

The Advanced menu allows you to configure your system for basic operation. Some entries are defaults required by the system board, while others, if enabled, will improve the performance of your system or let you set some features according to your preference.



### Important:

Setting incorrect field values may cause the system to malfunction.

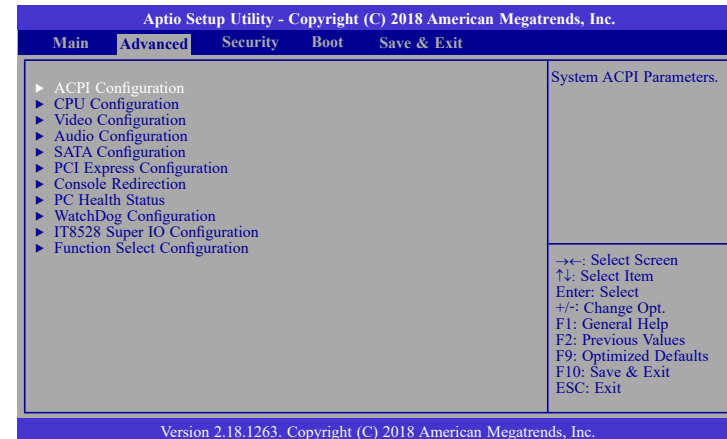



## ACPI Configuration

This section is used to configure ACPI settings.

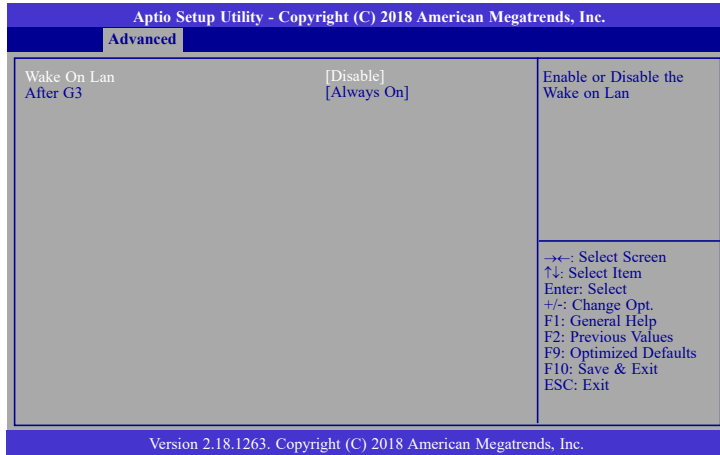

### Wake On Lan

Enable or Disable this field to use the LAN signal to wake up the system.

### After G3

This field is to specify what state the system should be in when power is re-applied after a power failure (G3, the mechanical-off, state).

**Always On** The system is in working state.

**Always Off** The system is in soft-off state, except for trickle current to devices such as the power button.



### Note:

If Quiet Boot is set to enabled, BGRT Logo field will appear for configuration. Refer to the Boot menu for more information.

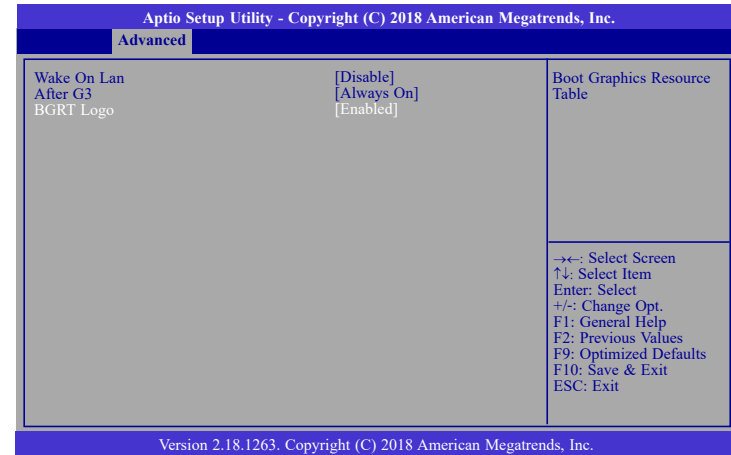

### BGRT Logo

This field is used to enable or disable to support display logo with ACPI Boot Graphics Resource Table.

## CPU Configuration

This section is used to configure the CPU.

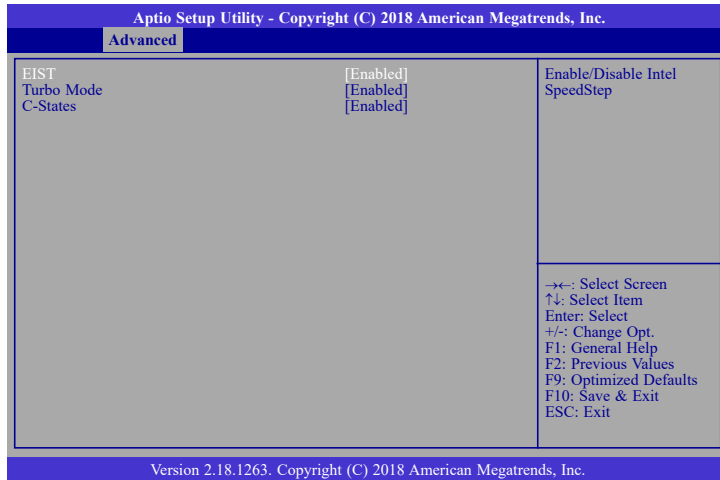

### EIST

This field is used to enable or disable the Enhanced Intel SpeedStep® Technology, which helps optimize the balance between system's power consumption and performance. After it is enabled in the BIOS, you can enable the EIST feature using the operating system's power management.

### Turbo Mode

This field is used to enable or disable processor turbo mode (required that EIST is enabled too), which allows the processor core to automatically run faster than the base frequency when the processor's power, temperature, and specification are within the limits of TDP.

### C-States

Enable or disable CPU Power Management. It allows CPU to go to C States when it's not 100% utilized.

## Video Configuration

This section configures the video settings.

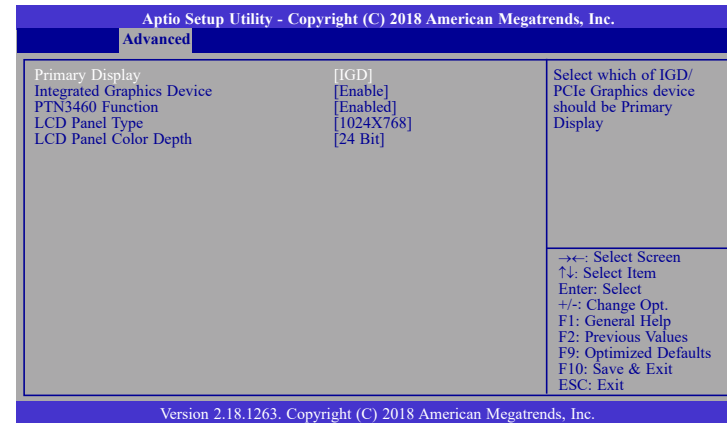

### Primary Display

Select either IGD or PCIe Graphics device to be the primary display.

### Integrated Graphics Device

Enable or disable the integrated graphics device (IGD). When enabled, the integrated graphics device is selected as the primary video adaptor.

### PTN3460 Function

Enable or disable PTN3460 LCD features.

### LCD Panel Type

Please check the specifications of your LCD monitor. Select the type of LCD panel connected to the system's LCD connector: 800X480, 800X600, 1024X768, 1366X768, 1280X1024 or 1920X1080.

### LCD Panel Color Depth

Select the LCD panel color depth: 18 Bit, 24 Bit, 36 Bit or 48 Bit.

## Audio Configuration

This section configures the audio settings.

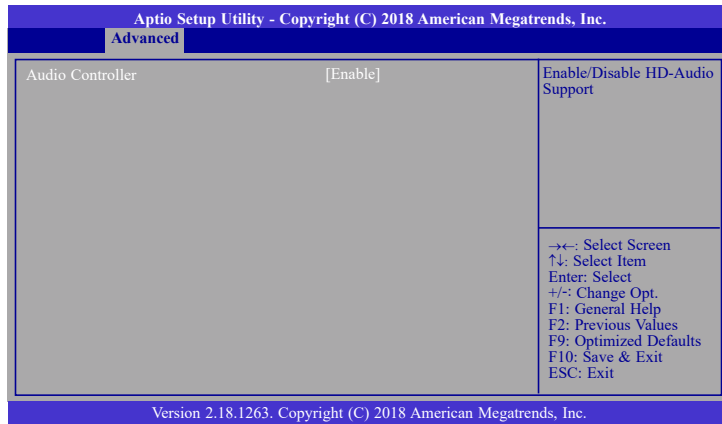

### Audio Controller

Control the detection of the high-definition audio device.

#### Disable

HD Audio will be disabled.

#### Enable

HD Audio will be enabled.

## SATA Configuration

This section configures the SATA controller.

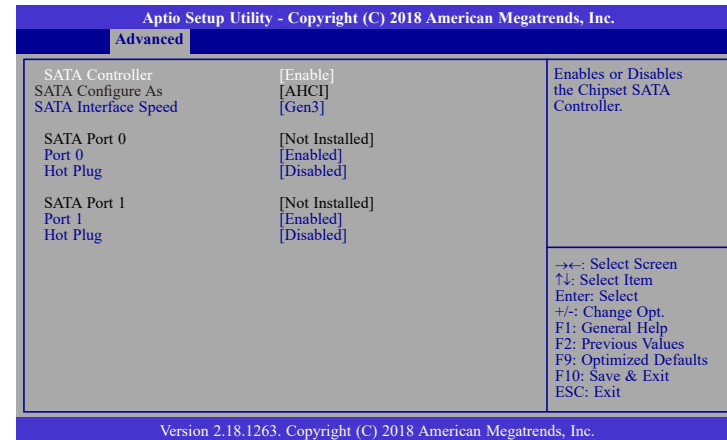

### SATA Controller

This field is used to enable or disable the Serial ATA controller.

### SATA Configure As

The mode selection determines how the SATA controller(s) operates.

#### AHCI

This option allows the Serial ATA controller(s) to use AHCI (Advanced Host Controller Interface).

### SATA Interface Speed

Select Serial ATA controller(s) speed from Gen1 (1.5 Gbit/s), Gen2 (3 Gbit/s) or Gen 3 (6 Gbit/s).

### SATA Port 0 and 1/Hot Plug

Enable or disable the Serial ATA port and its hot plug function.

## PCI Express Configuration

This section configures settings relevant to PCI Express devices.

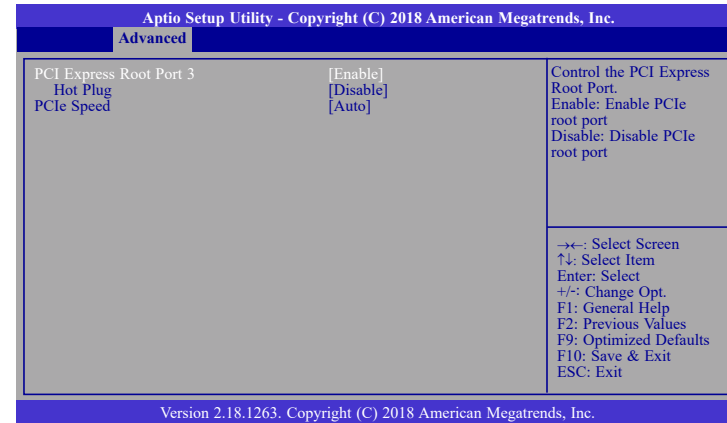
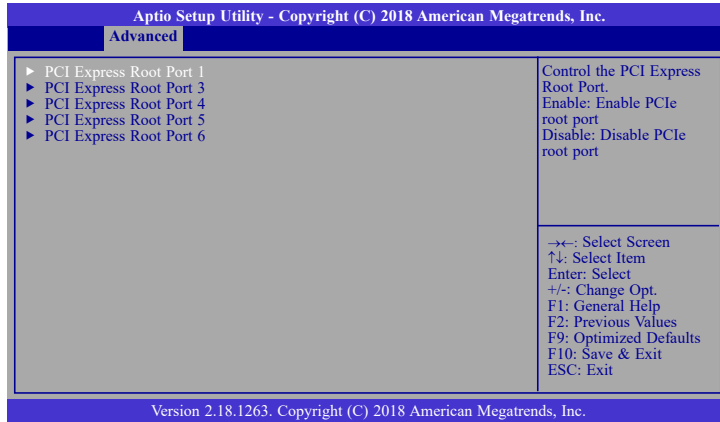

### PCI Express Root Port

This field is used to enable or disable the PCI express root port.

### Hot Plug

Enable or disable the hot plug function of the PCI Express root port.

### PCIe Speed

Select the speed of the PCI Express root port: Auto, Gen1 or Gen2.

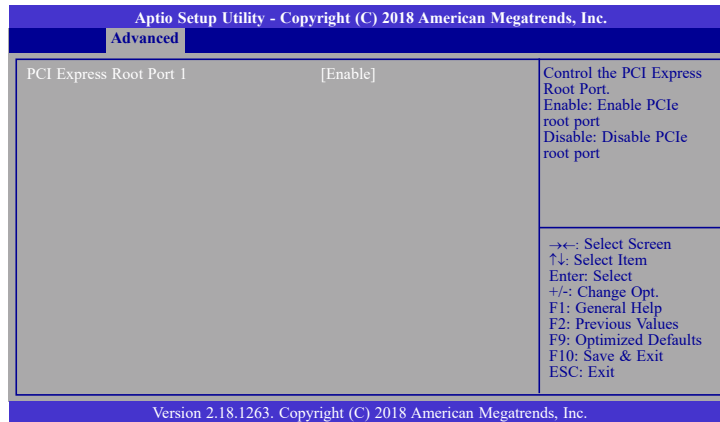

## Console Redirection

This section configures settings relevant to console redirection.

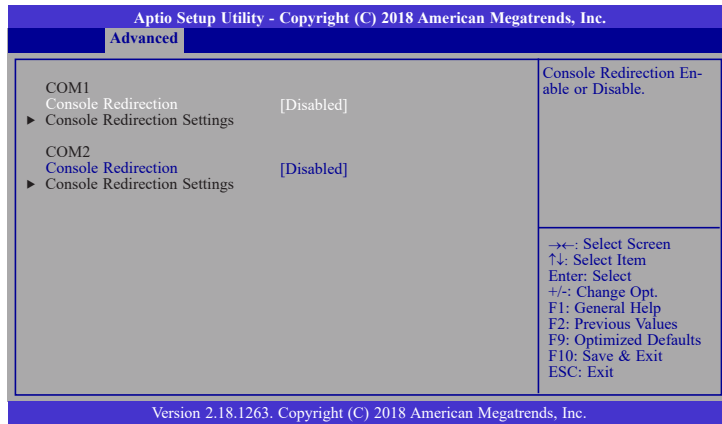

## Console Redirection

This field is used to enable or disable the console redirection function. When console redirection is set to enabled, console redirection settings are available like below screen.

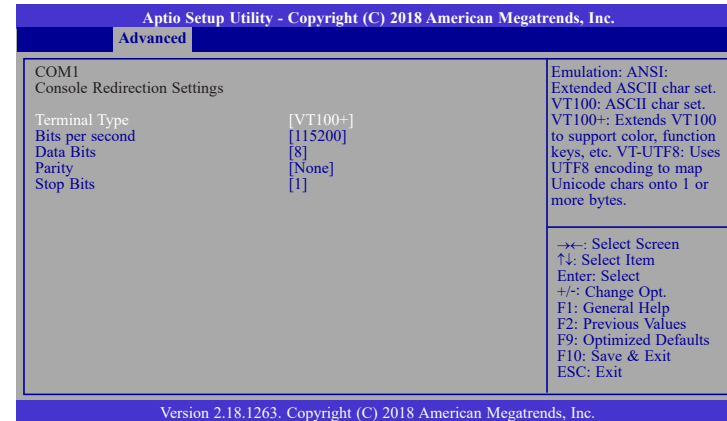
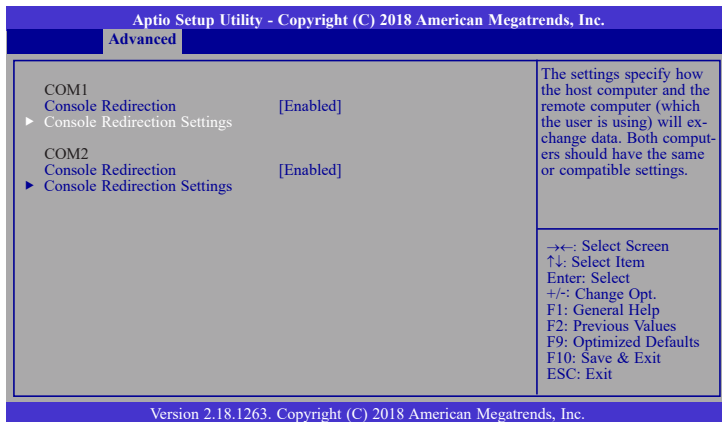

## Terminal Type

Select terminal type: VT100, VT100+, VT-UTF8 or ANSI.

## Bits per second

Select serial port transmission speed: 9600, 19200, 38400, 57600 or 115200.

## Data Bits

Select data bits: 7 bits or 8 bits.

## Parity

Select parity bits: none, even or odd.

## Stop Bits

Select stop bits: 1 bit or 2 bits.

## PC Health Status

This section only displays the hardware health monitor.

Aptio Setup Utility - Copyright (C) 2018 American Megatrends, Inc.		
Advanced		
Voltage		
VCORE	:	+0.909 V
VBAT	:	+3.243 V
VDDQ	:	+1.331 V
VGFX	:	+0.926 V
1.0v	:	+1.046 V
Temperature		
CPU (C/F)	:	+45 C / +113 F
FAN Speed		
SYS FAN	:	0 RPM
		→←: Select Screen ↑↓: Select Item Enter: Select +/-: Change Opt. F1: General Help F2: Previous Values F9: Optimized Defaults F10: Save & Exit ESC: Exit

Version 2.18.1263. Copyright (C) 2018 American Megatrends, Inc.

## WatchDog Configuration

This section is used to configure WatchDog parameters.

Aptio Setup Utility - Copyright (C) 2018 American Megatrends, Inc.		
Advanced		
WatchDog Configuration		Enable/Disable Watch-Dog Timer.
WatchDog Timer	[Disabled]	
		→←: Select Screen ↑↓: Select Item Enter: Select +/-: Change Opt. F1: General Help F2: Previous Values F9: Optimized Defaults F10: Save & Exit ESC: Exit

Version 2.18.1263. Copyright (C) 2018 American Megatrends, Inc.

## Watchdog Timer

Enable or disable watchdog timer.

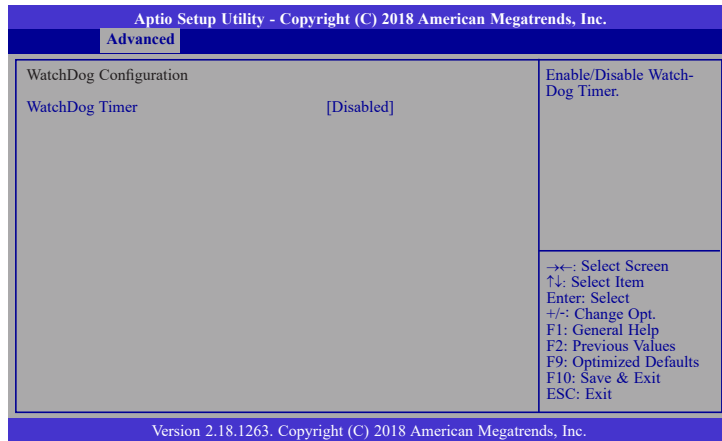

### Output Options

Select the Output Options.

Mode1 (System Reset) = A Watchdog Timeout causes the system to be reset.

Mode2 (Output Only) = WDT pin goes high upon timeout of the watchdog timer.

### Enable Delay

The enable delay allows time for the OS to boot and the application to load and initialize. The unit is 1 sec.

### Timeout Delay

The timeout delay allows time for period of the watchdog timer. The unit is 0.1 sec.

## Function Select Configuration

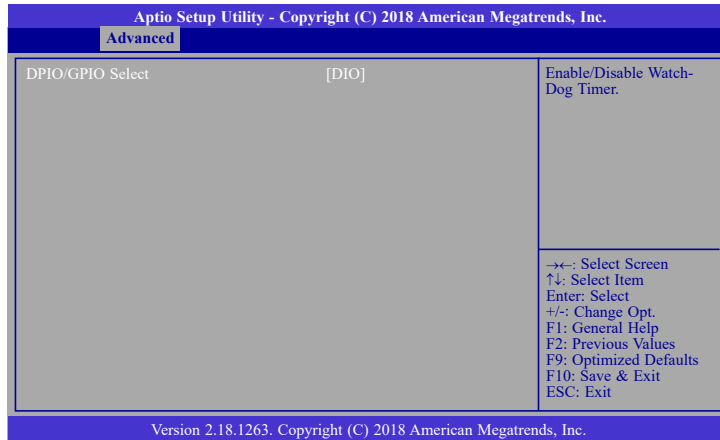

### DPIO/GPIO Select

Select DIO or GPIO funtion.



## IT8528 Super IO Configuration

This section configures the system super I/O chip parameters.

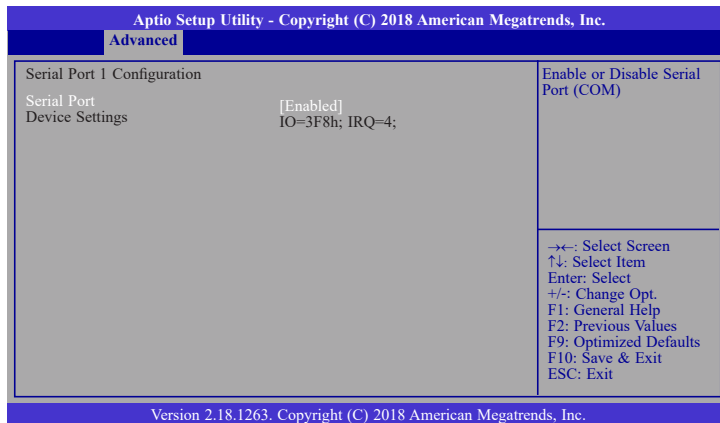
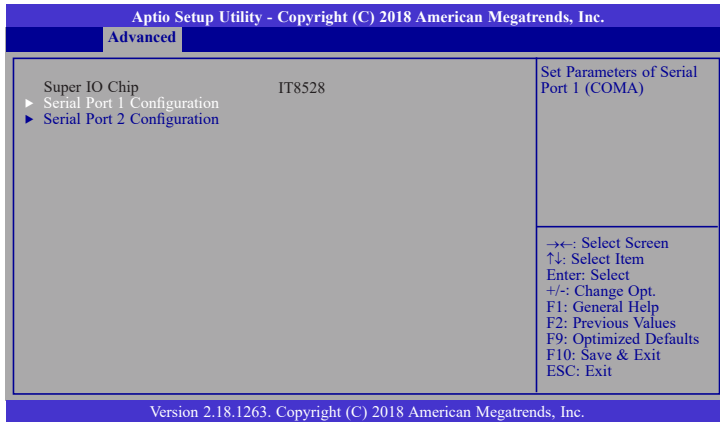

### Serial Port 1 and 2

This field is used to enable or disable the serial port (COM).

## Security

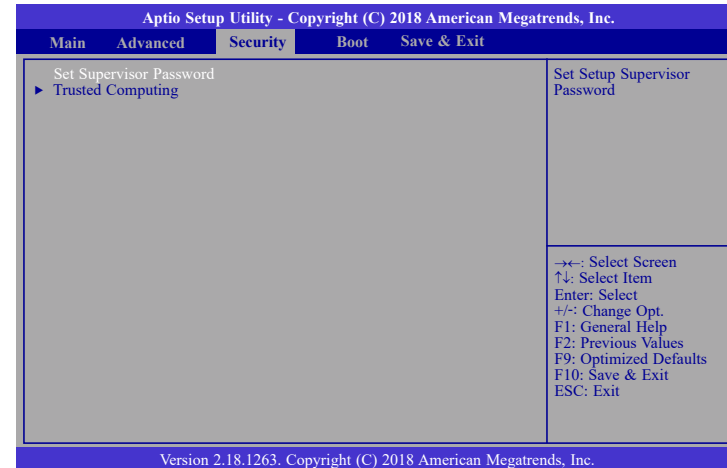

### Set Supervisor Password

Set the supervisor password.

### Trusted Computing

This section configures settings relevant to Trusted Computing innovations.

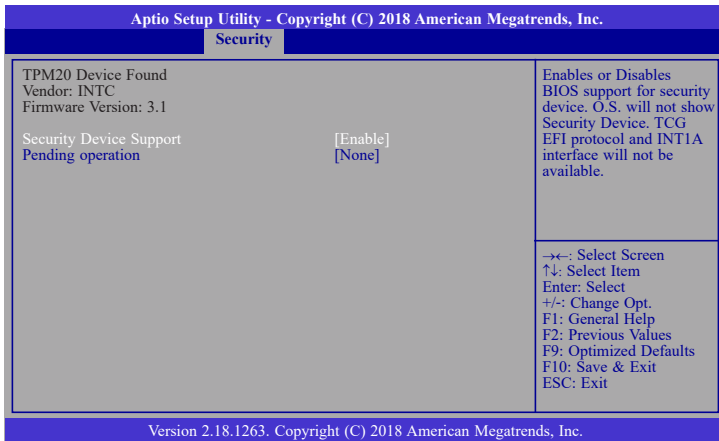

### Security Device Support

Enables or Disables the BIOS support for the security device. O.S. will not show the security device. TCG EFI protocol and TNT1A interface will not be available.

### Pending operation

Schedule an operation for the security device.



**Note:**

Your computer will reboot during restarting in order to change the security device state.

## Boot

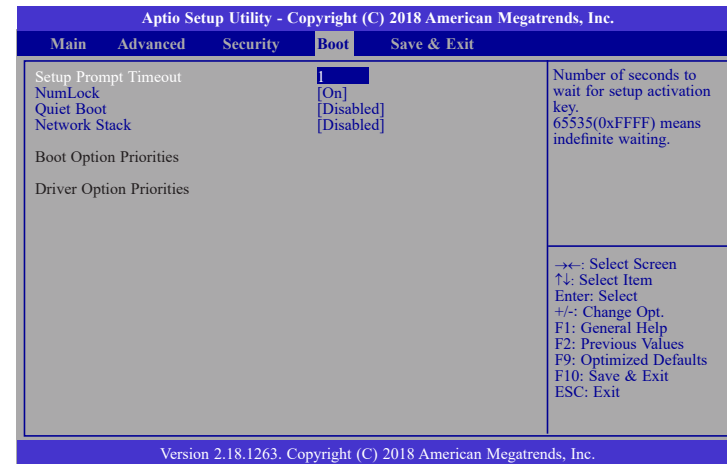

### Setup Prompt Timeout

Select the number of seconds to wait for the setup activation key. 65535 (0xFFFF) denotes indefinite waiting.

### NumLock

This allows you to determine the default state of the numeric keypad. By default, the system boots up with NumLock on wherein the function of the numeric keypad is the number keys. When set to Off, the function of the numeric keypad is the arrow keys.

### Quiet Boot

This section is used to enable or disable quiet boot option.

### Network Stack

This section is used to enable or disable UEFI network stack. When Network Stack is set to enabled, it will display Ipv4 PXE Support and Ipv6 PXE Support.

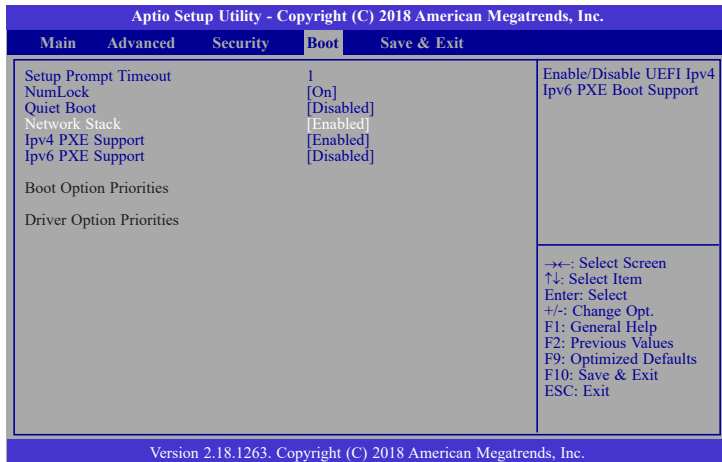

### Ipv4 PXE Support

When enabled, Ipv4 PXE boot supports. When disabled, Ipv4 PXE boot option will not be created.

### Ipv6 PXE Support

When enabled, Ipv6 PXE boot supports. When disabled, Ipv6 PXE boot option will not be created.

### Boot Option Priorities

Sets the system boot order.

### Driver Option Priorities

Sets the driver boot order.



**Note:**

AL9A8 only supports UEFI boot, no Legacy boot.

## Save & Exit

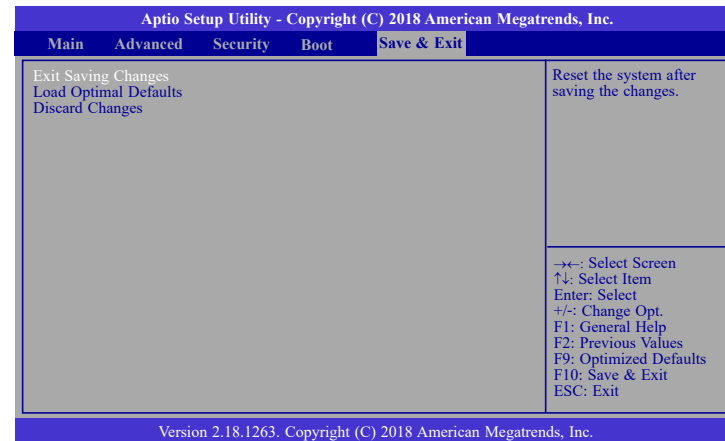

### Exit Saving Changes

Select Yes and then press <Enter> to exit the system setup and save your changes.

### Load Optimal Defaults

Select Yes and then press <Enter> to load optimal defaults.

### Discard Changes

Select Yes and then press <Enter> to exit the system setup without saving your changes.

## Updating the BIOS

To update the BIOS, you will need the new BIOS file and a flash utility. Please contact technical support or your sales representative for the files. For updating AMI BIOS in UEFI mode, you may refer to the how-to-video at <https://www.dfi.com/Knowledge/Video/5> .

## Notice: BIOS SPI ROM

1. The Intel® Trusted Execution Engine has already been integrated into this system board. Due to the safety concerns, the BIOS (SPI ROM) chip cannot be removed from this system board and used on another system board of the same model.
2. The BIOS (SPI ROM) on this system board must be the original equipment from the factory and cannot be used to replace one which has been utilized on other system boards.
3. If you do not follow the methods above, the Intel® Trusted Execution Engine will not be updated and will cease to be effective.



### Note:

- a. You can take advantage of flash tools to update the default configuration of the BIOS (SPI ROM) to the latest version anytime.
- b. When the BIOS IC needs to be replaced, you have to populate it properly onto the system board after the EEPROM programmer has been burned and follow the technical person's instructions to confirm that the MAC address should be burned or not.

## Chapter 5 - Supported Software

Please download drivers, utilities and software applications required to enhance the performance of the system board at <https://www.dfi.com/product/index/148#download>.

### Intel Chipset Software Installation Utility

The Intel Chipset Software Installation Utility is used for updating Windows® INF files so that the Intel chipset can be recognized and configured properly in the system.

To install the utility, download "AL9A8 Chipset Driver" zip file at our website.

1. Setup is ready to install the utility. Click "Next".

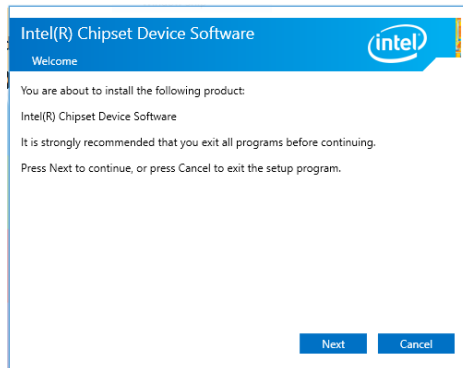

2. Read the license agreement then click "Accept".

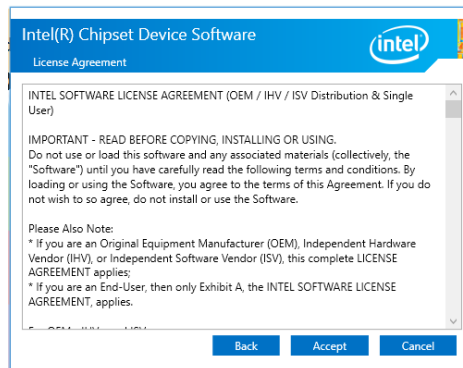

3. Go through the readme document for more installation tips then click "Install".

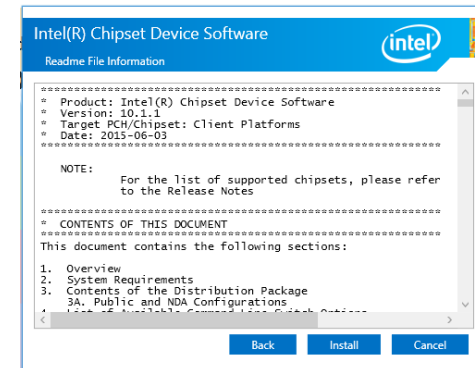

4. The step displays the installing status in the progress.

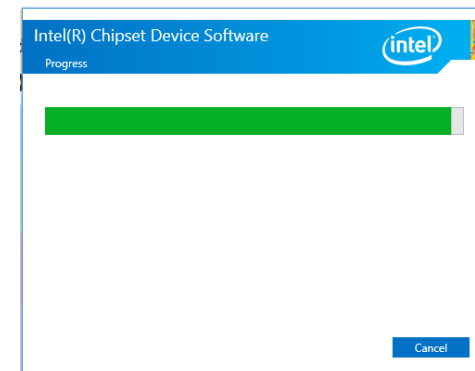

5. After completing installation, click "Restart Now" to exit setup.

Restarting the system will allow the new software installation to take effect.

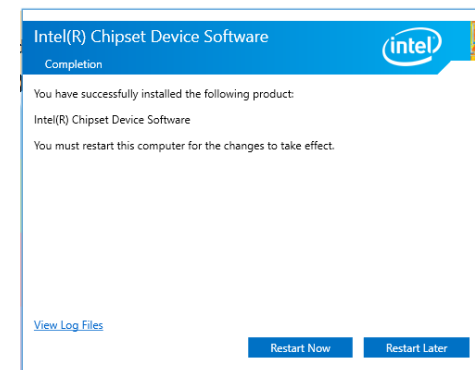

## Intel Graphics Driver

To install the driver, download "AL9A8 Graphics Driver" zip file at our website.

1. Setup is now ready to install the graphics driver. Click "Next".

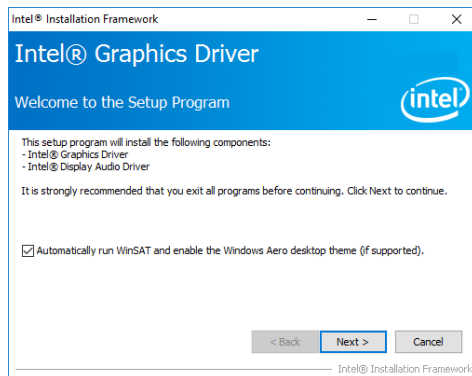

By default, the "Automatically run WinSAT and enable the Windows Aero desktop theme" is enabled. With this enabled, after installing the graphics driver and the system rebooted, the screen will turn blank for 1 to 2 minutes (while WinSAT is running) before the Windows 10 desktop appears. The "blank screen" period is the time Windows is testing the graphics performance.

We recommend that you skip this process by disabling this function then click "Next".

2. Read the license agreement then click "Yes".

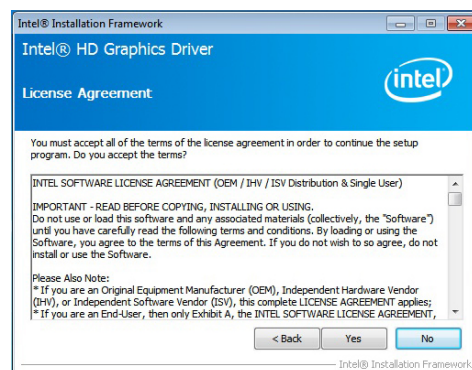

3. Go through the readme document for system requirements and installation tips then click "Next".

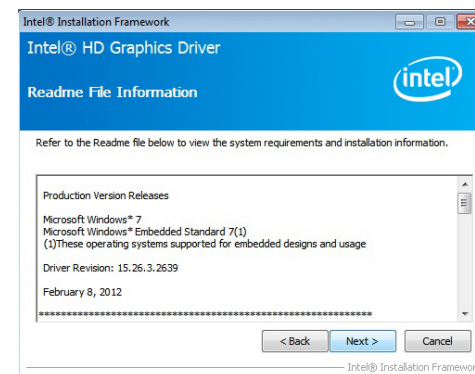

4. Setup is now installing the driver. Click "Next" to continue.

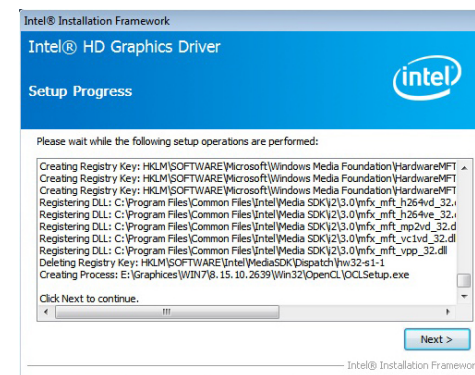

5. Click "Yes, I want to restart this computer now" then click "Finish".

Restarting the system will allow the new software installation to take effect.

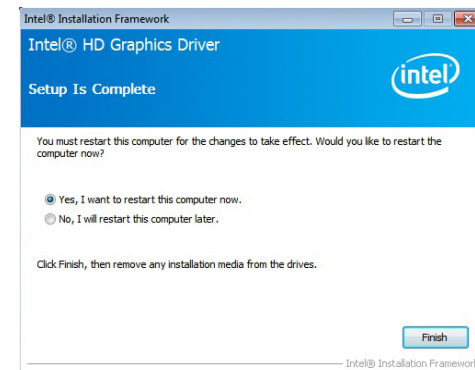

## Audio Drivers

To install the driver, download "AL9A8 Audio Driver" zip file at our website.

1. Setup is ready to install the driver. Click "Next".

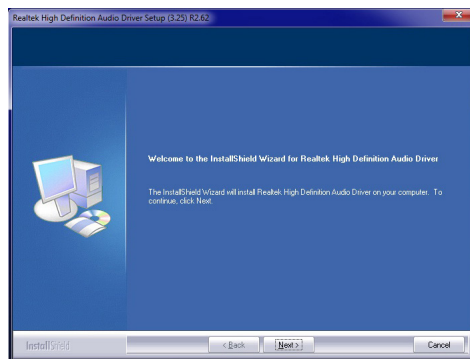

2. Click "Yes, I want to restart my computer now" then click "Finish".

Restarting the system will allow the new software installation to take effect.

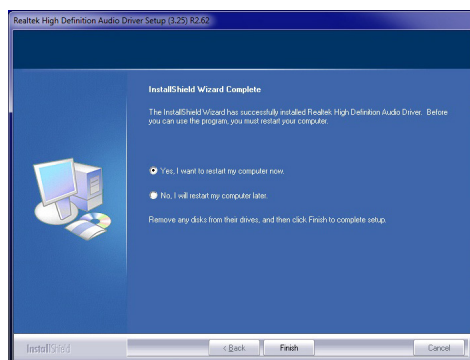

## Intel LAN Driver

To install the driver, download "AL9A8 LAN Driver" zip file at our website.

1. Setup is ready to install the driver. Click "Next".

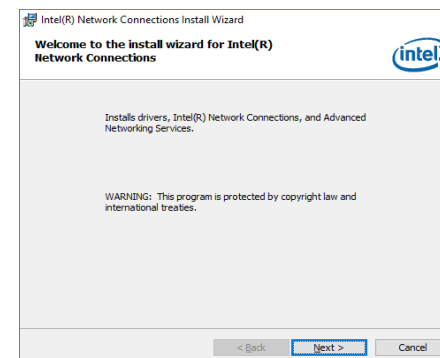

2. Click "I accept the terms in the license agreement" then click "Next".

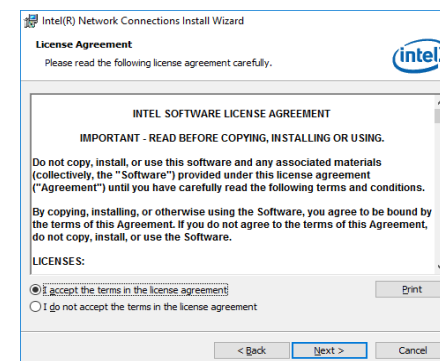

3. Select the program features you want installed then click "Next".

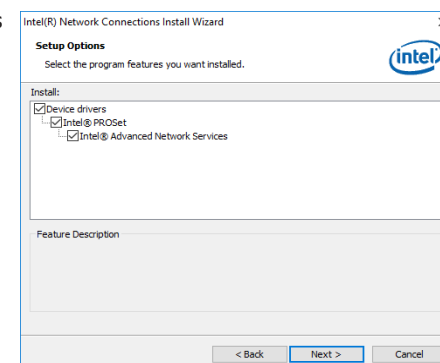

4. Click "Install" to begin the installation.

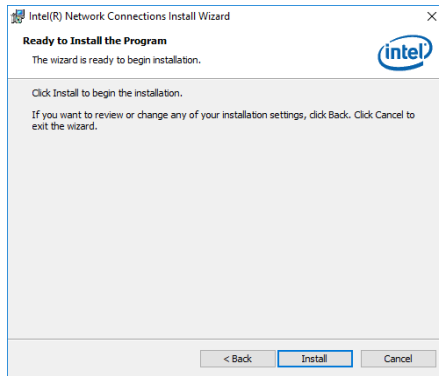

6. After completing installation, click "Finish".

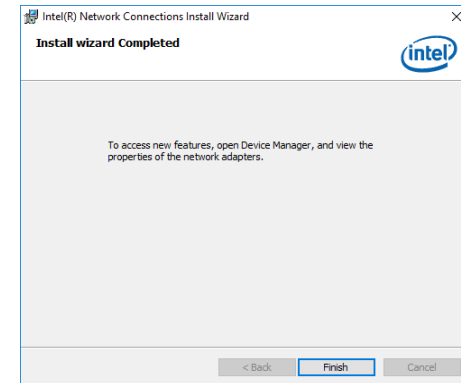

5. The step displays the installing status in the progress.

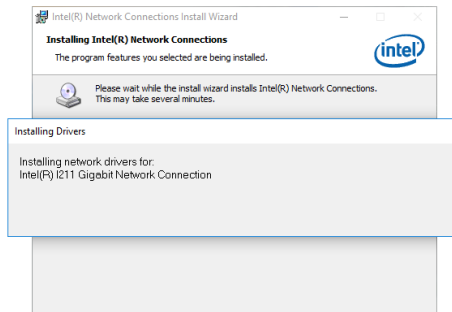



## Intel Trusted Execution Engine Driver

To install the driver, download "AL9A8 TXE Driver" zip file at our website.

1. Tick "I accept the terms in the License Agreement" and then click "Next".

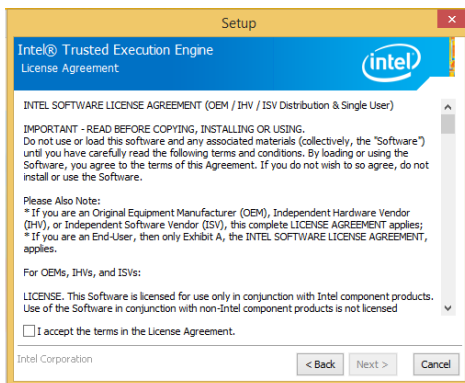

2. The step shows the components which will be installed. Then, Click "Next".

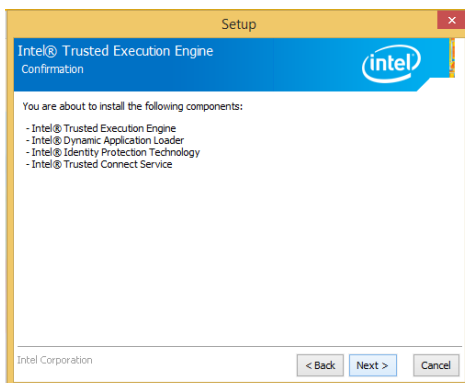

3. The step displays the installing status in the progress.

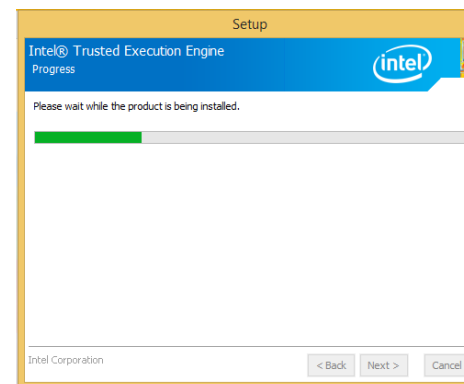

4. Click "Finish" when the installation is complete.

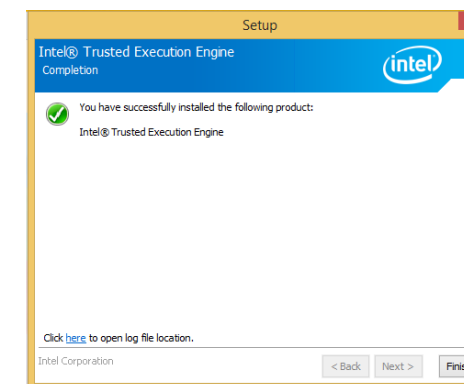

## SIO Driver

To install the driver, download "AL9A8 SIO Driver" zip file at our website.

1. Setup is ready to install the driver.  
Click "Next".

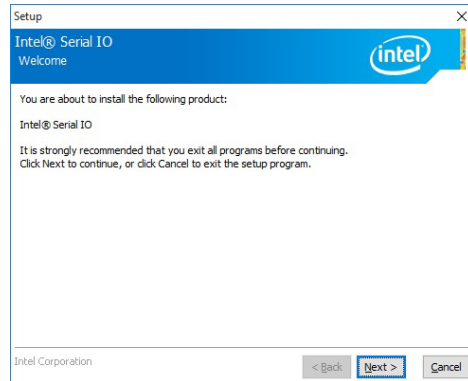

3. Read the file information then click "Next".

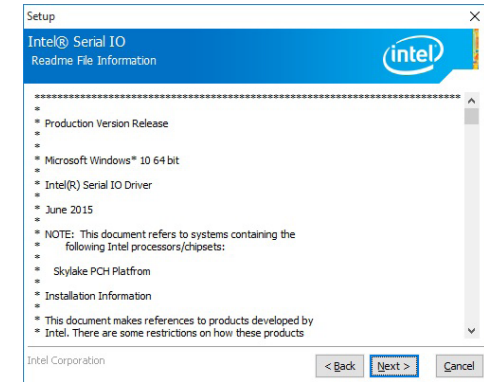

2. Read the license agreement carefully.  
Click "I accept the terms in the License Agreement" then click "Next".

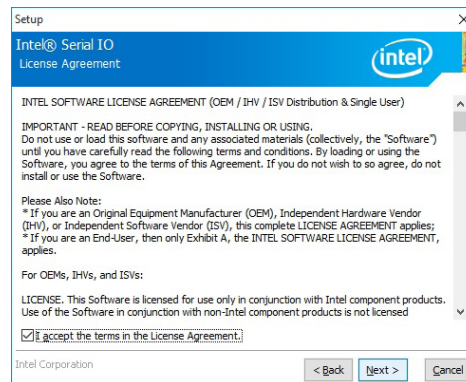

4. Setup is ready to install the driver.  
Click "Next".

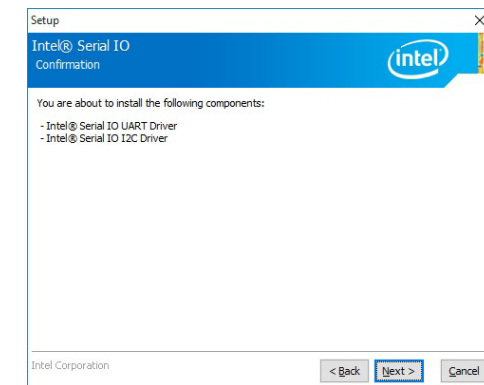

5. Setup is now installing the driver.

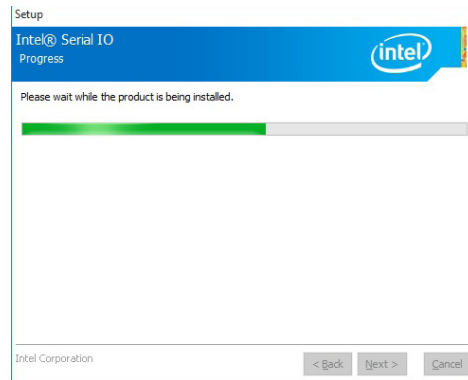

6. Click "Finish".

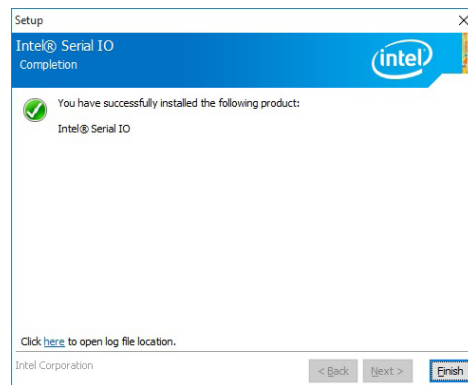

## Chapter 6 - GPIO Programming Guide

### Function Description

Get\_EC\_Data (unsigned char ucData): Read a Byte data from EC.

Write\_EC\_Data (unsigned char ucData, unsigned char Data): Write a Byte data to EC.

### Sample Code

#### GPIO Input Process

```
EC_DIO_Read_Input()
{
    BYTE Data;

    //Pin0-3 Input Mode
    Data = Get_EC_Data(0xBA);
    Data |= 0x80;
    Write_EC_Data(0xBA, Data);
    while(((Get_EC_Data(0xBA) >> 7)&0x01))
    {
        Data = Get_EC_Data(0xBA);
    }

    Return Data ;
}
```

#### GPIO Output Process

```
EC_DIO_Write_Output(unsigned char udata)
{
    //Pin4-7 Output Mode
    udata <<= 4;
    udata |= 0x01;
    Write_EC_Data(0xBB, udata);

    return 0;
}

EC_DIO_Read_Output()
{
    BYTE Data;

    //Pin4-7 Output Mode
    Write_EC_Data(0xBB, 0x02);
    Delay;
    Data = Get_EC_Data(0xBB);
    Data >>= 4;
    Return Data ;
}
```

## Appendix A - Watchdog Sample Code

```
#include <stdio.h>
//-----
#define EC_EnablePort 0x66
#define EC_DataPort 0x62
//-----
void WriteEC(char,int);
void SetWdTime(int,int);
int GetWdTime(void);
//-----
main()
{
    unsigned int countdown;
    unsigned int input,count_h,count_l;

    printf("Input WD Time: ");
    scanf("%d",&input);
    printf("\n");
    count_h=input>>8;
    count_l=input&0x00FF;
    SetWdTime(count_h,count_l);

    while(1)
    {
        countdown = GetWdTime();
        delay(100);
        printf("\rTime Remaining: %d ",countdown);
    }
}
//-----
void SetWdTime(int count_H,int count_L)
{
    //Set Count
    WriteEC(0xB5,count_H); //High Byte
    WriteEC(0xB6,count_L); //Low Byte
    //Enable Watch Dog Timer
    WriteEC(0xB4,0x01);
}
//-----
```

```
int GetWdTime(void)
{
    int sum,data_h,data_l;
    //Select EC Read Type
    outportb(EC_EnablePort,0x80);
    delay(5);
    //Get Remaining Count High Byte
    outportb(EC_DataPort,0xF4);
    delay(5);
    data_h=inportb(EC_DataPort);
    delay(5);
    //Select EC Read Type
    outportb(EC_EnablePort,0x80);
    delay(5);
    //Get Remaining Count Low Byte
    outportb(EC_DataPort,0xF5);
    delay(5);
    data_l=inportb(EC_DataPort);
    delay(5);

    data_h<=8;
    data_h&=0xFF00;
    sum=data_h|data_l;
    return sum;
}
//-----
void WriteEC(char EC_Addr, int data)
{
    //Select EC Write Type
    outportb(EC_EnablePort,0x81);
    delay(5);
    outportb(EC_DataPort,EC_Addr);
    delay(5);
    outportb(EC_DataPort,data);
    delay(5);
}
//-----
```

## Appendix B - System Error Message

### Standard Status Codes

#### PEI Status Codes

0x11	Pre-memory CPU initialization is started
0x15	Pre-memory North Bridge initialization is started
0x19	Pre-memory South Bridge initialization is started
0x2A	OEM pre-memory initialization codes
0x2B	Memory initialization. Serial Presence Detect (SPD) data reading
0x2C	Memory initialization. Memory presence detection
0x2D	Memory initialization. Programming memory timing information
0x2E	Memory initialization. Configuring memory
0x2F	Memory initialization (other).

#### PEI Error Codes

0x50	Memory initialization error. Invalid memory type or incompatible memory speed
0x51	Memory initialization error. SPD reading has failed
0x52	Memory initialization error. Invalid memory size or memory modules do not match.
0x53	Memory initialization error. No usable memory detected

#### DXE Phase Codes

0x92	PCI Bus initialization is started
0x93	PCI Bus Hot Plug Controller Initialization
0x94	PCI Bus Enumeration
0x95	PCI Bus Request Resources
0x96	PCI Bus Assign Resources
0x99	Super IO Initialization
0x9A	USB initialization is started
0x9B	USB Reset
0x9C	USB Detect
0x9D	USB Enable
0xA0	IDE initialization is started
0xA1	IDE Reset
0xA2	IDE Detect
0xA3	IDE Enable
0xAE	Legacy Boot event
0xB4	USB hot plug
0xB6	Clean-up of NVRAM
0xB7	Configuration Reset (reset of NVRAM settings)

#### DXE Error Codes

0xD6	No Console Output Devices are found
0xD7	No Console Input Devices are found
0xD8	Invalid password

### ACPI Checkpoints

0x03	System is entering S3 sleep state
0x04	System is entering S4 sleep state
0x05	System is entering S5 sleep state
0x30	System is waking up from the S3 sleep state
0x40	System is waking up from the S4 sleep state
0xAC	System has transitioned into ACPI mode. Interrupt controller is in PIC mode.
0xAA	System has transitioned into ACPI mode. Interrupt controller is in APIC mode.

### Beep Code

6 beeps	Flash update is failed
---------	------------------------

## Appendix C - Troubleshooting

### Troubleshooting Checklist

This chapter of the manual is designed to help you with problems that you may encounter with your personal computer. To efficiently troubleshoot your system, treat each problem individually. This is to ensure an accurate diagnosis of the problem in case a problem has multiple causes.

Some of the most common things to check when you encounter problems while using your system are listed below.

1. The power switch of each peripheral device is turned on.
2. All cables and power cords are tightly connected.
3. The electrical outlet to which your peripheral devices connected is working. Test the outlet by plugging in a lamp or other electrical device.
4. The monitor is turned on.
5. The display's brightness and contrast controls are adjusted properly.
6. All add-in boards in the expansion slots are seated securely.
7. Any add-in board you have installed is designed for your system and is set up correctly.

### Monitor/Display

#### If the display screen remains dark after the system is turned on:

1. Make sure that the monitor's power switch is on.
2. Check that one end of the monitor's power cord is properly attached to the monitor and the other end is plugged into a working AC outlet. If necessary, try another outlet.
3. Check that the video input cable is properly attached to the monitor and the system's display adapter.
4. Adjust the brightness of the display by turning the monitor's brightness control knob.

#### The picture seems to be constantly moving.

1. The monitor has lost its vertical sync. Adjust the monitor's vertical sync.
2. Move away any objects, such as another monitor or fan, that may be creating a magnetic field around the display.
3. Make sure your video card's output frequencies are supported by this monitor.

#### The screen seems to be constantly wavering.

1. If the monitor is close to another monitor, the adjacent monitor may need to be turned off. Fluorescent lights adjacent to the monitor may also cause screen wavering.

### Power Supply

#### When the computer is turned on, nothing happens.

1. Check that one end of the AC power cord is plugged into a live outlet and the other end properly plugged into the back of the system.
2. Make sure that the voltage selection switch on the back panel is set for the correct type of voltage you are using.
3. The power cord may have a "short" or "open". Inspect the cord and install a new one if necessary.



## Hard Drive

### Hard disk failure.

1. Make sure the correct drive type for the hard disk drive has been entered in the BIOS.
2. If the system is configured with two hard drives, make sure the bootable (first) hard drive is configured as Master and the second hard drive is configured as Slave. The master hard drive must have an active/bootable partition.

### Excessively long formatting period.

If your hard drive takes an excessively long period of time to format, it is likely a cable connection problem. However, if your hard drive has a large capacity, it will take a longer time to format.

## Serial Port

### The serial device (modem, printer) doesn't output anything or is outputting garbled characters.

1. Make sure that the serial device's power is turned on and that the device is on-line.
2. Verify that the device is plugged into the correct serial port on the rear of the computer.
3. Verify that the attached serial device works by attaching it to a serial port that is working and configured correctly. If the serial device does not work, either the cable or the serial device has a problem. If the serial device works, the problem may be due to the onboard I/O or the address setting.
4. Make sure the COM settings and I/O address are configured correctly.

## Keyboard

### Nothing happens when a key on the keyboard was pressed.

1. Make sure the keyboard is properly connected.
2. Make sure there are no objects resting on the keyboard and that no keys are pressed during the booting process.

## System Board

1. Make sure the add-in card is seated securely in the expansion slot. If the add-in card is loose, power off the system, re-install the card and power up the system.
2. Check the jumper settings to ensure that the jumpers are properly set.
3. Verify that all memory modules are seated securely into the memory sockets.
4. Make sure the memory modules are in the correct locations.
5. If the board fails to function, place the board on a flat surface and seat all socketed components. Gently press each component into the socket.
6. If you made changes to the BIOS settings, re-enter setup and load the BIOS defaults.