



SD106

Mini-ITX Industrial Motherboard User's Manual

Copyright

This publication contains information that is protected by copyright. No part of it may be reproduced in any form or by any means or used to make any transformation/adaptation without the prior written permission from the copyright holders.

This publication is provided for informational purposes only. The manufacturer makes no representations or warranties with respect to the contents or use of this manual and specifically disclaims any express or implied warranties of merchantability or fitness for any particular purpose. The user will assume the entire risk of the use or the results of the use of this document. Further, the manufacturer reserves the right to revise this publication and make changes to its contents at any time, without obligation to notify any person or entity of such revisions or changes.

Changes after the publication's first release will be based on the product's revision. The website will always provide the most updated information.

© 2019. All Rights Reserved.

Trademarks

Product names or trademarks appearing in this manual are for identification purpose only and are the properties of the respective owners.

FCC and DOC Statement on Class B

This equipment has been tested and found to comply with the limits for a Class B digital device, pursuant to Part 15 of the FCC rules. These limits are designed to provide reasonable protection against harmful interference when the equipment is operated in a residential installation. This equipment generates, uses and can radiate radio frequency energy and, if not installed and used in accordance with the instruction manual, may cause harmful interference to radio communications. However, there is no guarantee that interference will not occur in a particular installation. If this equipment does cause harmful interference to radio or television reception, which can be determined by turning the equipment off and on, the user is encouraged to try to correct the interference by one or more of the following measures:

- Reorient or relocate the receiving antenna.
- Increase the separation between the equipment and the receiver.
- Connect the equipment into an outlet on a circuit different from that to which the receiver is connected.
- Consult the dealer or an experienced radio TV technician for help.

Notice:

1. The changes or modifications not expressly approved by the party responsible for compliance could void the user's authority to operate the equipment.
2. Shielded interface cables must be used in order to comply with the emission limits.

Table of Contents

Copyright.....	2	SATA (Serial ATA) Power Connectors.....	22
Trademarks.....	2	Digital I/O.....	23
FCC and DOC Statement on Class B.....	2	Cooling Fan Connectors.....	23
Warranty.....	4	Chassis Intrusion Connector.....	24
Static Electricity Precautions.....	4	Front Panel Connector.....	24
Safety Measures.....	4	Expansion Slots.....	25
About the Package.....	5	Standby Power LED.....	26
Optional Items.....	5	LVDS Panel.....	27
Before Using the System Board.....	5	SMBus Connector.....	28
Chapter 1 - Introduction.....	6	Speaker Connector.....	28
Specifications.....	6	COM (Serial) Ports.....	29
Features.....	7	Front Audio Connector.....	29
Chapter 2 - Hardware Installation.....	8	Power ATX Mode.....	30
Board Layout.....	8	15~36V DC-in.....	30
System LED.....	8	EDP Connector.....	31
System Memory.....	9	Battery.....	32
Installing the DIMM Module.....	9	Chapter 3 - BIOS Setup.....	33
CPU.....	10	Overview.....	33
Installing the CPU.....	11	Main.....	34
Installing the Fan and Heat Sink.....	13	Advanced.....	34
Jumper Settings.....	14	ACPI Configuration.....	35
Clear CMOS Data.....	14	CPU Configuration.....	36
Auto Power-on Select.....	14	Video Configuration.....	36
LVDS Panel Power Select.....	15	Audio Configuration.....	37
PCIe1 Signal Select.....	15	SATA Configuration.....	38
LCD/Inverter Power Select.....	16	USB Configuration.....	38
LVDS Backlight Power Select.....	16	PCI Express Configuration.....	39
Mini PCIe 1 Signal Select.....	17	ME Configuration.....	40
Mini PCIe 2 Signal Select.....	17	Active Management Technology Support.....	40
eDP Panel Power Select.....	18	MEBX Configuration.....	41
eDP Inverter Power Select.....	18	Debug Configuration.....	41
eDP Backlight Power Select.....	19	Device Manager.....	42
Rear Panel I/O Ports.....	20	SIO NUVOTON6106D.....	43
Graphics Interfaces.....	20	Console Redirection.....	45
RJ45 LAN Ports.....	21	Security.....	47
USB Ports.....	21	Boot.....	47
I/O Connectors.....	22	Exit.....	48
SATA (Serial ATA) Connectors.....	22	Updating the BIOS.....	49
		Notice: BIOS SPI ROM.....	49
		Chapter 4 - Supported Software.....	50
		Chapter 5 - RAID.....	67
		Chapter 6 - Intel AMT Settings.....	71

Warranty

1. Warranty does not cover damages or failures that arise from misuse of the product, inability to use the product, unauthorized replacement or alteration of components and product specifications.
2. The warranty is void if the product has been subjected to physical abuse, improper installation, modification, accidents or unauthorized repair of the product.
3. Unless otherwise instructed in this user's manual, the user may not, under any circumstances, attempt to perform service, adjustments or repairs on the product, whether in or out of warranty. It must be returned to the purchase point, factory or authorized service agency for all such work.
4. We will not be liable for any indirect, special, incidental or consequential damages to the product that has been modified or altered.

Static Electricity Precautions

It is quite easy to inadvertently damage your PC, system board, components or devices even before installing them in your system unit. Static electrical discharge can damage computer components without causing any signs of physical damage. You must take extra care in handling them to ensure against electrostatic build-up.

1. To prevent electrostatic build-up, leave the system board in its anti-static bag until you are ready to install it.
2. Wear an antistatic wrist strap.
3. Do all preparation work on a static-free surface.
4. Hold the device only by its edges. Be careful not to touch any of the components, contacts or connections.
5. Avoid touching the pins or contacts on all modules and connectors. Hold modules or connectors by their ends.



Important:

Electrostatic discharge (ESD) can damage your processor, disk drive and other components. Perform the upgrade instruction procedures described at an ESD workstation only. If such a station is not available, you can provide some ESD protection by wearing an antistatic wrist strap and attaching it to a metal part of the system chassis. If a wrist strap is unavailable, establish and maintain contact with the system chassis throughout any procedures requiring ESD protection.

Safety Measures

To avoid damage to the system:

- Use the correct AC input voltage range.

To reduce the risk of electric shock:

- Unplug the power cord before removing the system chassis cover for installation or servicing. After installation or servicing, cover the system chassis before plugging the power cord.

About the Package

The package contains the following items. If any of these items are missing or damaged, please contact your dealer or sales representative for assistance.

- 1 SD106-Q170 motherboard
- 1 Battery Addendum

The board and accessories in the package may not come similar to the information listed above. This may differ in accordance to the sales region or models in which it was sold. For more information about the standard package in your region, please contact your dealer or sales representative.

Before Using the System Board

Before using the system board, prepare basic system components.

If you are installing the system board in a new system, you will need at least the following internal components.

- A CPU
- Memory module
- Storage devices such as hard disk drive, etc.

You will also need external system peripherals you intend to use which will normally include at least a keyboard, a mouse and a video display monitor.

Chapter 1 - Introduction

Specifications

SYSTEM	Processor	6th Generation Intel® Core™ Processors, LGA 1151 Socket Intel® Pentium® G4400, Dual Core, 3M Cache, 3.3GHz, 47W
	Chipset	Intel® Q170 Chipset
	Memory	Two 260-pin SODIMM up to 32GB Dual Channel DDR4 1866/2133MHz
	BIOS	Insyde SPI 128Mbit
GRAPHICS	Controller	Intel® HD Gen 9 Graphics
	Feature	OpenGL 5.0, DirectX 12, OpenCL 2.1 HW Decode: AVC/H.264, MPEG2, VC1/WMV9, JPEG/MJPEG, HEVC/H265, VP8, VP9 HW Encode: MPEG2, AVC/H.264, JPEG, HEVC/H265, VP8, VP9
	Display	1 x eDP eDP: resolution up to 4096x2304 @ 60Hz 1 x LVDS LVDS: resolution up to 1920x1200 @ 60Hz 1 x DP++ DP++: resolution up to 4096x2304 @ 60Hz
	Triple Displays	eDP + LVDS + DP++
EXPANSION	Interface	1 x Full-size Mini PCIe (USB/PCIe/mSATA, mSATA by default) 1 x Half-size Mini PCIe (Mini PCIe by default) 1 x PCIe x16 (Max. 75W)
AUDIO	Audio Codec	Realtek ALC888S-VD2-GR
ETHERNET	Controller	1 x Intel® I211AT PCIe (10/100/1000Mbps) 1 x Intel® I219LM PCIe with iAMT 11.0 (10/100/1000Mbps) (only Core i7/i5 supports iAMT)
REAR I/O	Ethernet	2 x GbE (RJ-45)
	USB	4 x USB 3.0
	Display	1 x DP++

INTERNAL I/O	Serial	2 x RS-232 (2.54mm pitch)
	USB	4 x USB 2.0 (2.00mm pitch)
	Display	1 x eDP 1 x LVDS LCD Panel Connector
	Audio	1 x Front Audio (Line-out/Mic-in) 1 x Speaker (3W amplifier)
	SATA	2 x SATA 3.0 (up to 6Gb/s) RAID 0/1
	DIO	1 x 4-bit DIO
	SMBus	1 x SMBus
WATCHDOG TIMER	Output & Interval	System Reset, Programmable via Software from 1 to 255 Seconds
SECURITY	TPM	TPM2.0
POWER	Type	15~36V DC
	Connector	Vertical Type Connector (4-pin)
	RTC Battery	CR2032 Coin Cell
OS SUPPORT		Windows 7 Windows 8.1 Windows 10
ENVIRONMENT	Temperature	Operating: 0 to 60°C Storage: -40 to 85°C
	Humidity	Operating: 5 to 90% RH Storage: 5 to 90% RH
MECHANICAL	Dimensions	Mini-ITX Form Factor 170mm (6.7") x 170mm (6.7")

Features

● Watchdog Timer

The Watchdog Timer function allows your application to regularly “clear” the system at the set time interval. If the system hangs or fails to function, it will reset at the set time interval so that your system will continue to operate.

● DDR4

DDR4 delivers increased system bandwidth and improves performance. The advantages of DDR4 provide an extended battery life and improve the performance at a lower power than DDR3/DDR2.

● Graphics

The integrated Intel® HD graphics engine delivers an excellent blend of graphics performance and features to meet business needs. It provides excellent video and 3D graphics with outstanding graphics responsiveness. These enhancements deliver the performance and compatibility needed for today's and tomorrow's business applications. Supports 1 eDP, 1 LVDS and 1 DP++ interfaces for display outputs.

● PCI Express

PCI Express is a high bandwidth I/O infrastructure that possesses the ability to scale speeds by forming multiple lanes. The PCI Express architecture also supports high performance graphics infrastructure by enhancing the capability of a PCIe x16 Gen 3 at 16GB/s bandwidth.

● Serial ATA

Serial ATA is a storage interface that is compliant with SATA 1.0a specification. With speed of up to 6Gb/s (SATA 3.0), it improves hard drive performance faster than the standard parallel ATA whose data transfer rate is 100MB/s.

● Gigabit LAN

Intel® I211AT PCIe Gigabit Ethernet and Intel® I219LM PCIe with iAMT11.0 Gigabit Ethernet Phy controllers support up to 1Gbps data transmission.

● Audio

The Realtek ALC888S-VD2-GR audio codec provides 5.1-channel High Definition audio output.

● Wake-On-LAN

This feature allows the network to remotely wake up a Soft Power Down (Soft-Off) PC. It is supported via the onboard LAN port or via a PCIe LAN card that uses the PCIe PME (Power Management Event) signal. However, if your system is in the Suspend mode, you can power-on the system only through an IRQ or DMA interrupt.

● Wake-On-USB

This function allows you to use a USB keyboard or USB mouse to wake up a system from the S3 (STR - Suspend To RAM) state.

● RTC Timer

The RTC installed on the system board allows your system to automatically power-on on the set date and time.

● ACPI STR

The system board is designed to meet the ACPI (Advanced Configuration and Power Interface) specification. ACPI has energy saving features that enables PCs to implement Power Management and Plug-and-Play with operating systems that support OS Direct Power Management. ACPI when enabled in the Power Management Setup will allow you to use the Suspend to RAM function.

With the Suspend to RAM function enabled, you can power-off the system at once by pressing the power button or selecting “Standby” when you shut down Windows® without having to go through the sometimes tiresome process of closing files, applications and operating system. This is because the system is capable of storing all programs and data files during the entire operating session into RAM (Random Access Memory) when it powers-off. The operating session will resume exactly where you left off the next time you power-on the system.

● Power Failure Recovery

When power returns after an AC power failure, you may choose to either power-on the system manually or let the system power-on automatically.

● USB

The system board supports the new USB 3.0. It is capable of running at a maximum transmission speed of up to 5 Gbit/s (625 MB/s) and is faster than USB 2.0 (480 Mbit/s, or 60 MB/s) and USB 1.1 (12Mb/s). USB 3.0 reduces the time required for data transmission, reduces power consumption, and is backward compatible with USB 2.0. It is a marked improvement in device transfer speeds between your computer and a wide range of simultaneously accessible external Plug and Play peripherals.

Chapter 2 - Hardware Installation

► Board Layout

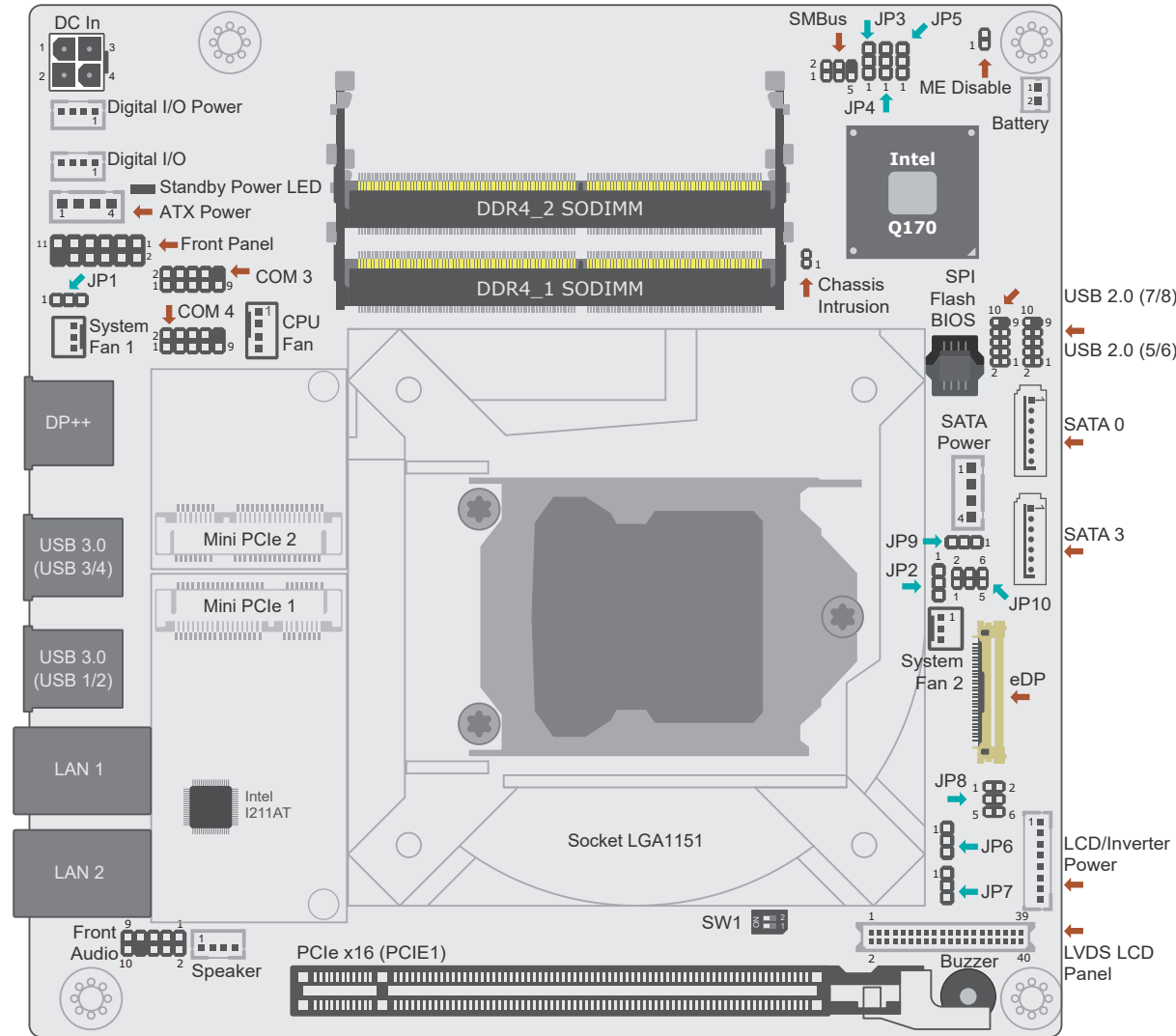

Important:

Electrostatic discharge (ESD) can damage your board, processor, disk drives, add-in boards, and other components. Perform installation procedures at an ESD workstation only. If such a station is not available, you can provide some ESD protection by wearing an antistatic wrist strap and attaching it to a metal part of the system chassis. If a wrist strap is unavailable, establish and maintain contact with the system chassis throughout any procedures requiring ESD protection.

► Standby Power LED



Important:

When the Standby Power LED lit red, it indicates that there is power on the system board. Power-off the PC then unplug the power cord prior to installing any devices. Failure to do so will cause severe damage to the motherboard and components.

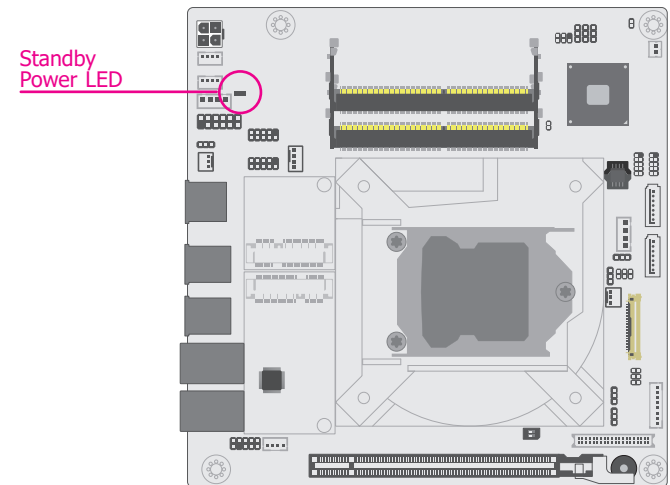

This LED lights red when the system is in the standby mode. It indicates that is supplied to the system board. Power-off the PC and then unplug the power cord prior to installing any devices. Failure to do so will cause severe damage to the motherboard and components.

► System Memory

The system board supports the following memory interface.

Single Channel (SC)

Data will be accessed in chunks of 64 bits from the memory channels.

Dual Channel (DC)

Data will be accessed in chunks of 128 bits from the memory channels. Dual channel provides better system performance because it doubles the data transfer rate.

Single Channel	DIMMs are on the same channel. DIMMs in a channel can be identical or completely different. However, we highly recommend using identical DIMMs. Not all slots need to be populated.
Dual Channel	DIMMs of the same memory configuration are on different channels.

BIOS Setting

Enable or disable ECC in the "Advanced" menu of the BIOS. Refer to Chapter 3 for more information.

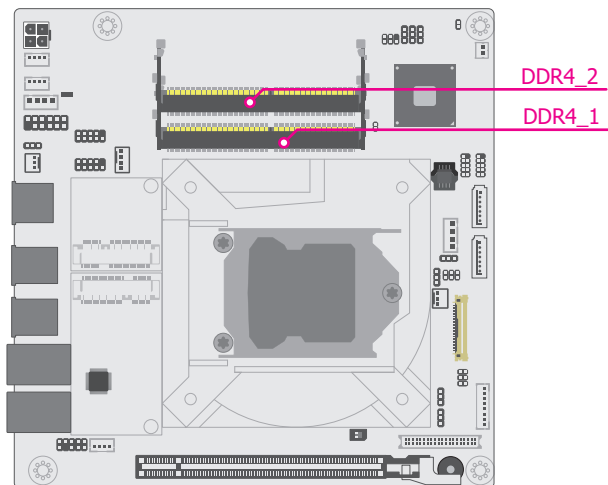

► System Memory

Installing the SO-DIMM Module

Before installing the memory module, please make sure that the following safety cautions are well-attended.

1. Make sure the PC and all other peripheral devices connected to it has been powered down.
2. Disconnect all power cords and cables.
3. Locate the SO-DIMM socket on the system board
4. Make sure the notch on memory card is aligned to the key on the socket.

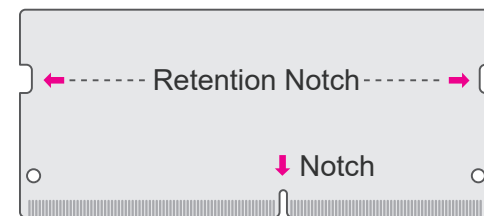

◀◀◀ **DDR4 SO-DIMM**

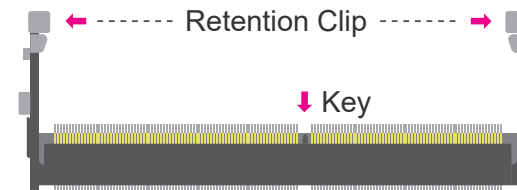

◀◀◀ **Socket Top View**

Features

- Two 260-pin SODIMM up to 32GB
- Dual Channel DDR4 1866/2133MHz

► System Memory ► Installing the SO-DIMM Module

Please follow the steps below to install the memory card into the socket.

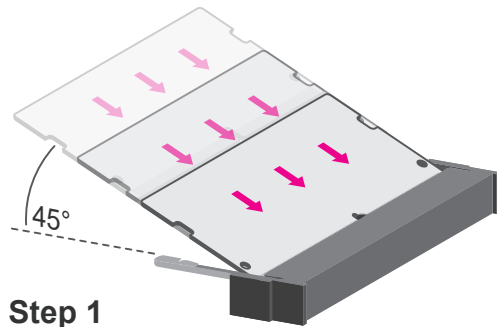

Step 1

Step 1:

Insert the memory card into the slot while making sure 1) the notch and the key are aligned, and 2) the non-connector end rises approximately 45 degrees horizontally. Press the card firmly into the socket while applying and maintaining even pressure on both ends.

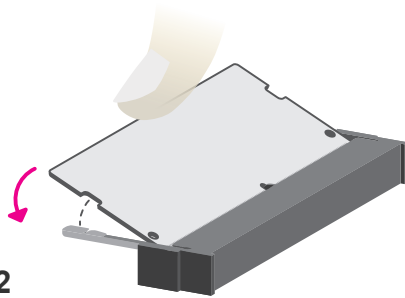

Step 2

Step 2:

Press the end of the card far from the socket down while making sure the retention notch and the clip align as indicated by the dotted line in the illustration. If the retention notch and the clip do not align, please remove the card and re-insert it. Press the card all the way down.

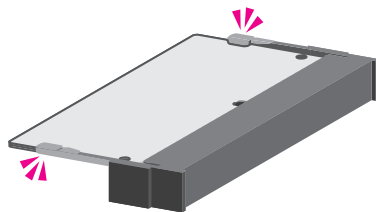

Step 3

Step 3:

The clips snap automatically and abruptly to the retention notches of the card sounding a distinctive click, and lock the card in place. Inspect that the clip sits in the notch. If not, please pull the clips outward, release and remove the card, and mount it again.

► CPU

The system board is equipped with a surface mount LGA 1151 socket. This socket is exclusively designed for installing a LGA 1151 packaged Intel CPU.



Important:

1. Before you proceed, make sure (1) the LGA 1151 socket comes with a protective cap, (2) the cap is not damaged and (3) the socket's contact pins are not bent. If the cap is missing or the cap and/or contact pins are damaged, contact your dealer immediately.
2. Make sure to keep the protective cap. RMA requests will be accepted and processed only if the LGA 1151 socket comes with the protective cap.

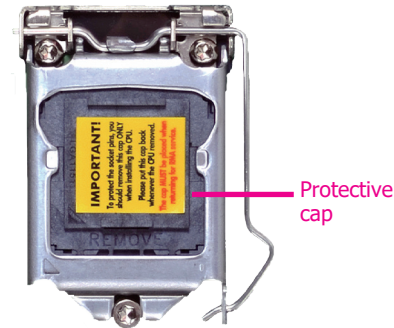

Note:

The system board used in the following illustrations may not resemble the actual board. These illustrations are for reference only.

► CPU

Installing the CPU

1. Make sure the PC and all other peripheral devices connected to it have been powered down.
2. Disconnect all power cords and cables.
3. Locate the LGA 1151 CPU socket on the system board.

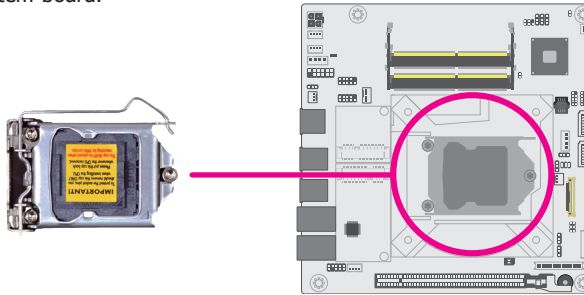
**Important:**

The CPU socket must not come in contact with anything other than the CPU. Avoid unnecessary exposure. Remove the protective cap only when you are about to install the CPU.

4. Unlock the socket by pressing the load lever down, moving it sideways until to escape the retention tab. Lift the load lever up when it's released.

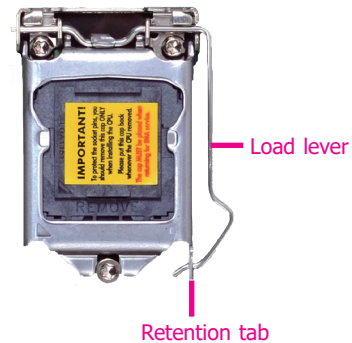

► CPU ► Installing the CPU

5. Lift the load lever and the load plate all the way up as shown in the photo.

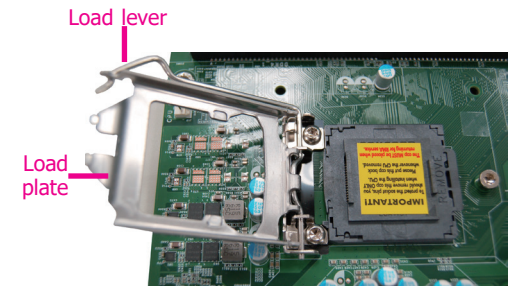

6. Remove the protective cap from the CPU socket. The cap is used to protect the CPU socket against dust and harmful particles. Remove the protective cap only when you are about to install the CPU.

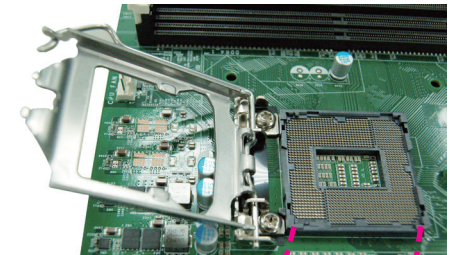

Protective cap



- 7.1. Insert the CPU into the socket. The gold triangular mark on the CPU must align with the chamfer corner of the CPU socket shown in the photo.



Golden triangular mark

► CPU ► Installing the CPU

7.2. Two keys on the socket and notches on the CPU also facilitate alignment.

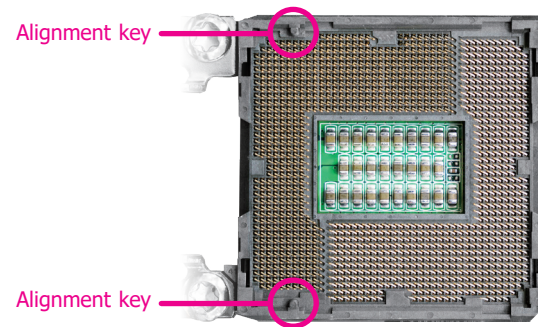
**Important:**

The CPU will fit in only one orientation and can easily be seated without exerting any force.

7.3. The CPU's notch will fit into the socket's alignment key when it's seated in the correct orientation.

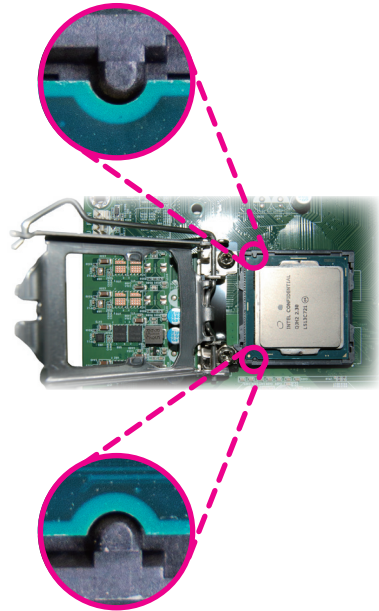

► CPU ► Installing the CPU

8. Close the load plate then push the load lever down.

While closing the load plate, make sure the front edge of the load plate slides under the retention knob.

9. Press down the load lever and hook it under the retention tab.

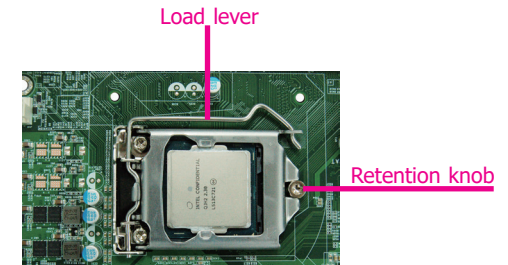

► CPU

Installing the Fan and Heat Sink

The CPU must be kept cool by using a CPU fan with heat sink. Without sufficient air circulation across the CPU and heat sink, the CPU will overheat damaging both the CPU and system board.

**Note:**

A boxed Intel® processor already includes the CPU fan and heat sink assembly. If your CPU was purchased separately, make sure to only use Intel®-certified fan and heat sink.

1. Before you install the fan / heat sink, you must apply a thermal paste onto the top of the CPU. The thermal paste is usually supplied when you purchase the fan / heat sink assembly. Do not spread the paste all over the surface. When you later place the heat sink on top of the CPU, the compound will disperse evenly.

Some heat sinks come with a patch of pre-applied thermal paste. Do not apply thermal paste if the fan / heat sink already has a patch of thermal paste on its underside. Peel the strip that covers the paste before you place the fan / heat sink on top of the CPU.

2. Place the heat sink on top of the CPU. The 4 spring screws around the heat sink, which are used to secure the heat sink onto the system board, must match the 4 mounting holes around the socket.

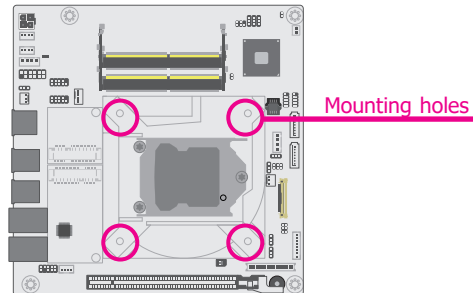

3. Orient the heat sink so that the CPU fan's cable is nearest the CPU fan connector.

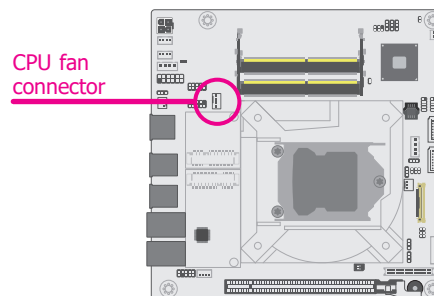
► CPU ► **Installing the Fan and Heat Sink**

4. Screw tight two of the spring screws at opposite corners into the mounting holes. And then proceed with the other two spring screws.

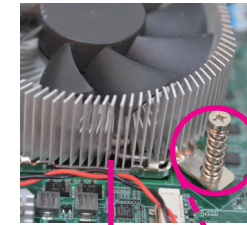

Heat sink

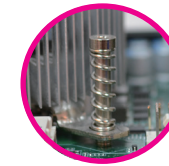

"Locked" position of push-pin

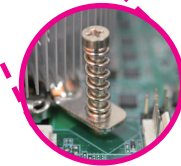

"Unlocked" position of push-pin

5. Connect the CPU fan's cable to the CPU fan connector on the system board.

► Jumper Settings

Clear CMOS Data

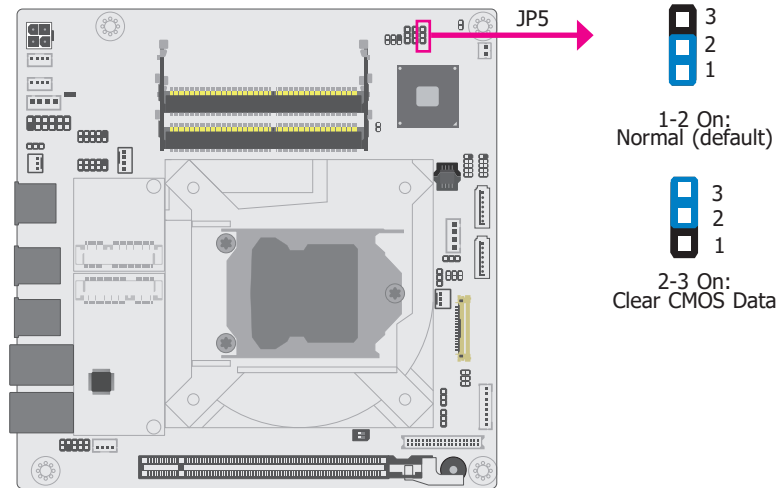

► Jumper Settings

Auto Power-on Select

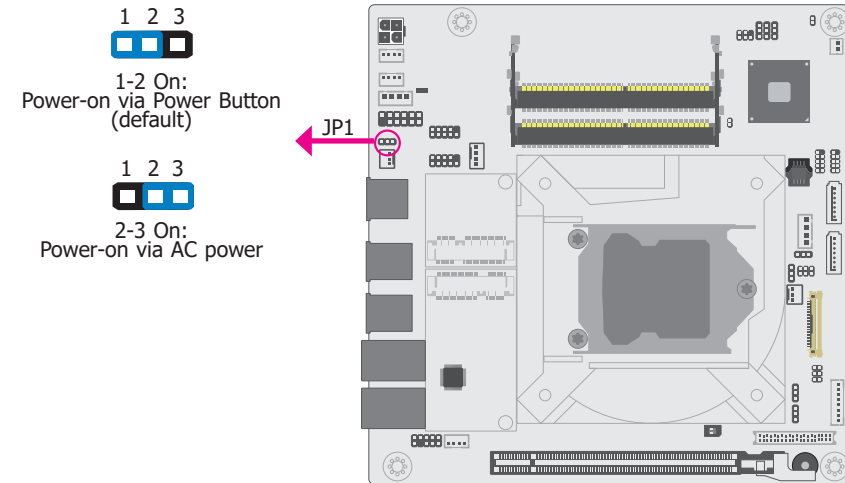

If any anomaly of the followings is encountered —

- CMOS data is corrupted;
- you forgot the supervisor or user password;
- failure to start the system due to BIOS mis-configuration

— it is suggested that the system be reconfigured with default values stored in the ROM BIOS. To load the default values stored in the ROM BIOS, please follow the steps below.

- Power-off the system and unplug the power cord.
- Put a jumper cap on JP5's pin 2 and pin 3. Wait for a few seconds and set JP5 back to its default setting, i.e. jumper cap on pin 1 and pin 2.
- Plug the power cord and power-on the system.

JP1 is used to select the method of powering on the system. If you want the system to power-on whenever AC power comes in, set JP1 pins 2 and 3 to On. If you want to use the power button, set pins 1 and 2 to On.

When using the JP1 "Power On" feature to power the system back on after a power failure occurs, the system may not power on if the power lost is resumed within 5 seconds (power flicker).

► Jumper Settings

LVDS Panel Power Select

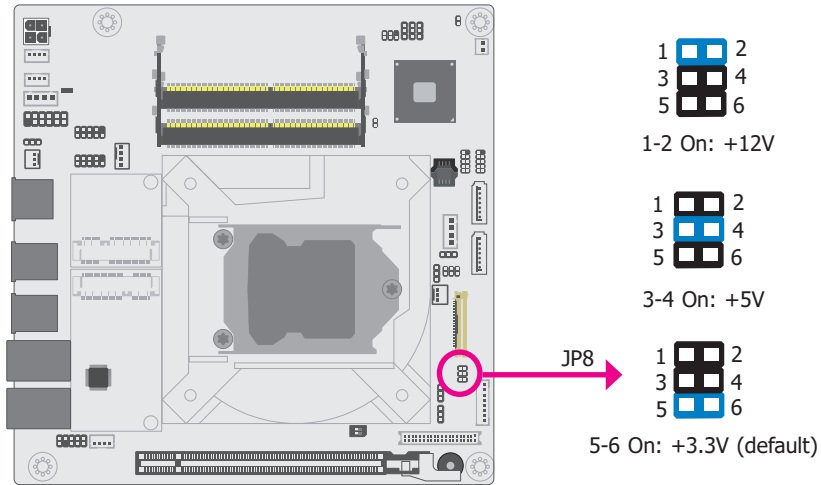

JP8 is used to select the power supplied with the LCD panel.



Important:

Before powering-on the system, make sure that the power settings of JP8 match the LCD panel's specification. Selecting the incorrect voltage will seriously damage the LCD panel.

► Jumper Settings

PCIe1 Signal Select

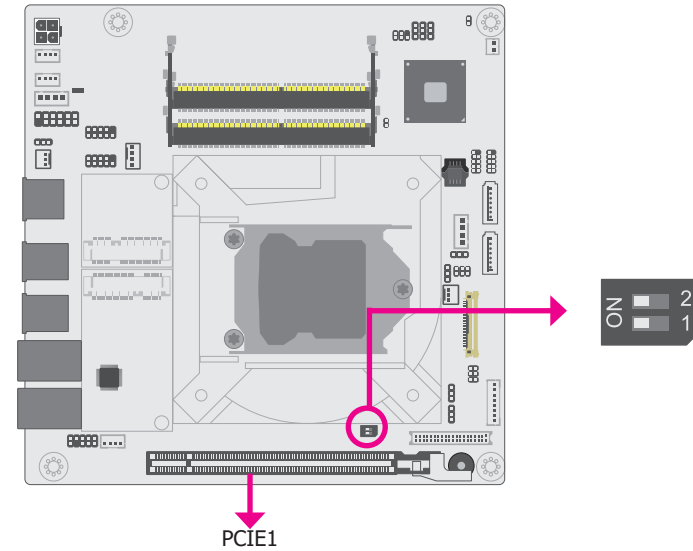

SW1 is used to select the signal of the PCIe1 slot, a PCIe x16 socket that can be configured to multiple signal lane settings as listed below.

PCIe1 Signal Select	SW1	
PCIe x16 (default)	1 Off, 2 Off	
Two PCIe x8	1 On, 2 Off	
One PCIe x8 + Two PCIe x4	1 On, 2 On	

► Jumper Settings

LCD/Inverter Power Select

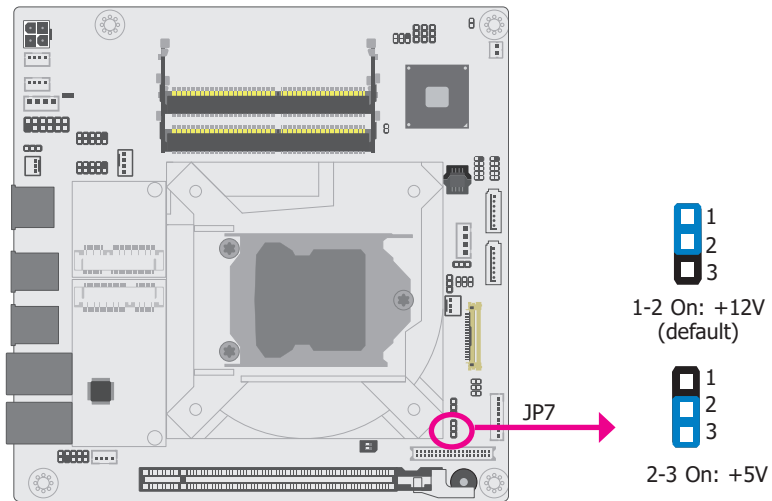

JP7 is used to select the power level of the LCD inverter power connector.

► Jumper Settings

LVDS Backlight Power Select

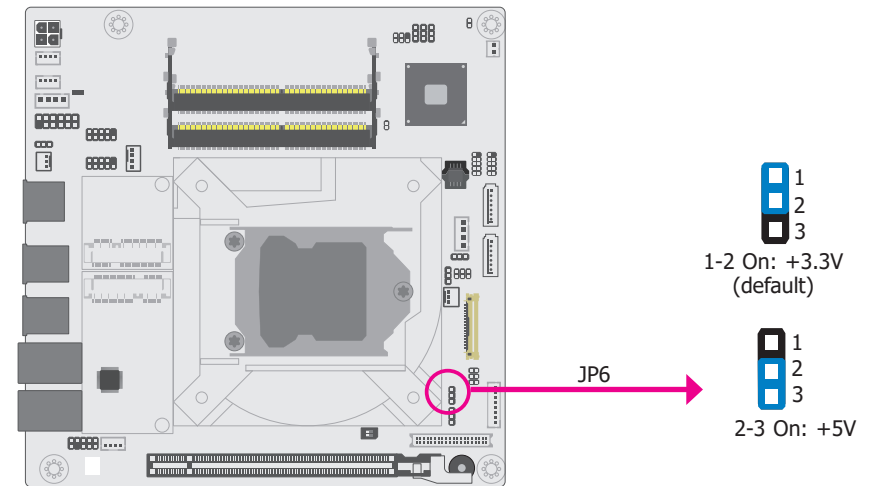

JP6 is used to select the power level of backlight brightness control of the LVDS port: +3.3V or +5V.

**Important:**

Before powering-on the system, make sure that the power settings of JP6 match the power specification of backlight control. Selecting the incorrect voltage will seriously damage the backlight.

► Jumper Settings

Mini PCIe 1 Signal Select

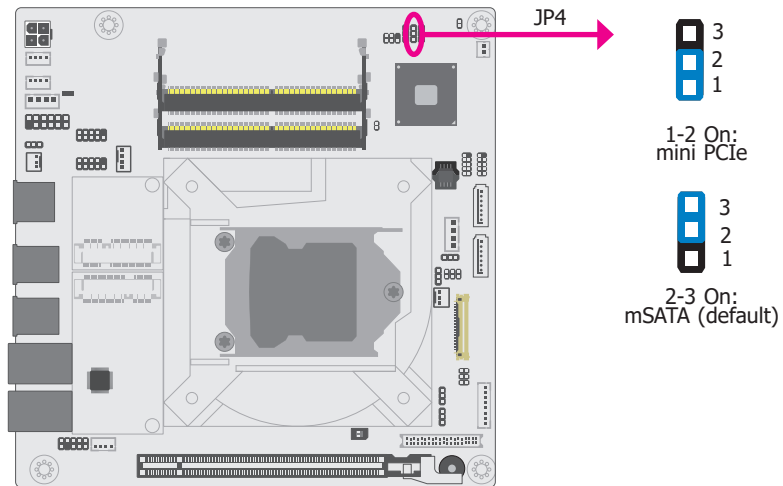

JP4 is used to select the Mini PCIe 1 (full-size) signal: mini PCIe or mSATA (default).

► Jumper Settings

Mini PCIe 2 Signal Select

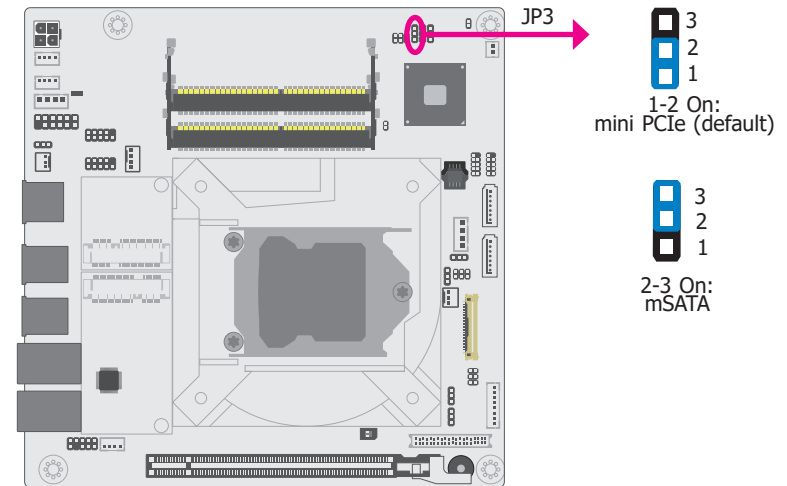

JP3 is used to select the Mini PCIe 2 (half-size) signal: mini PCIe (default) or mSATA.

▶ Jumper Settings

eDP Panel Power Select

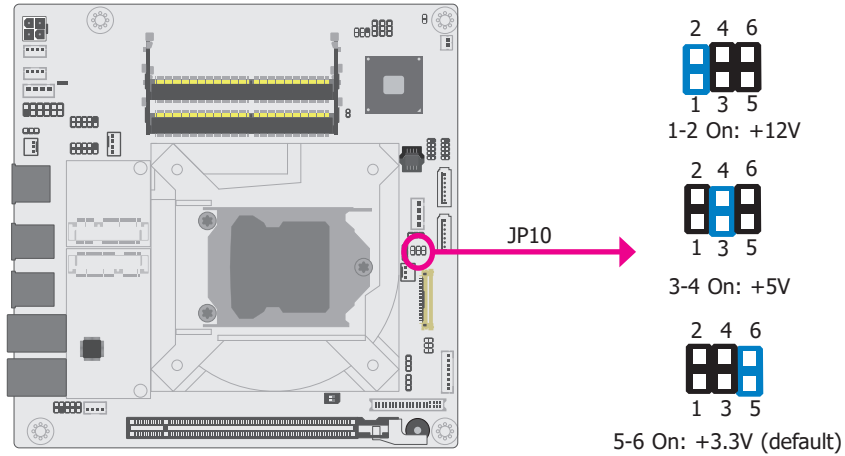

JP10 is used to select the power supplied with the panel connected via the eDP port.

**Important:**

Before powering-on the system, make sure that the power settings of JP10 match the panel's specification. Selecting the incorrect voltage will seriously damage the LCD panel.

▶ Jumper Settings

eDP Inverter Power Select

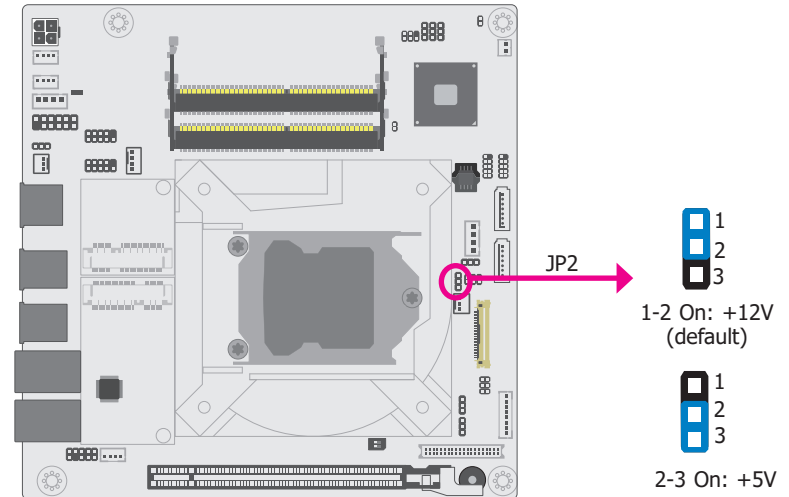

JP2 is used to select the power level of the eDP inverter power connector.

► Jumper Settings

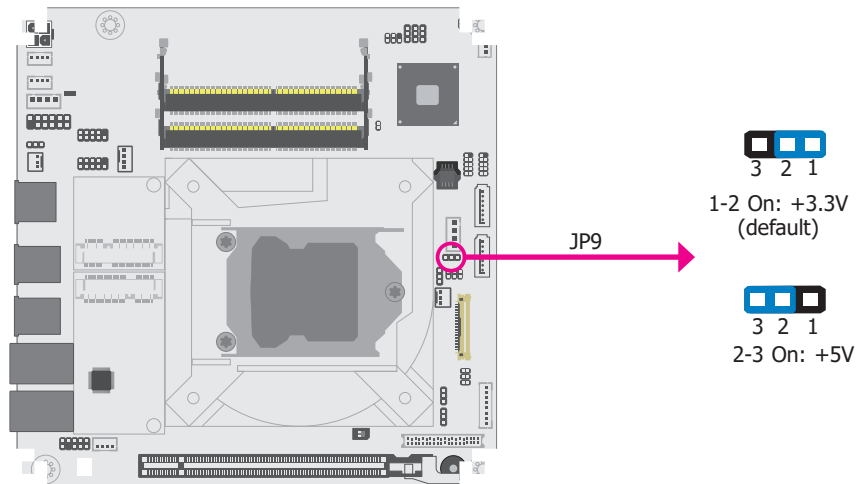
eDP Backlight Power Select

JP9 is used to select the power level of backlight brightness control of the eDP port: +3.3V or +5V.

**Important:**

Before powering-on the system, make sure that the power settings of JP9 match the power specification of backlight control. Selecting the incorrect voltage will seriously damage the backlight.

▶ Rear Panel I/O Ports



The rear panel I/O ports consist of the following:

- 1 DP++
- 4 USB 3.0 ports
- 2 RJ45 LAN ports

▶ Rear Panel I/O Ports Graphics Interface

The display ports consist of the following:

- 1 DP++ port

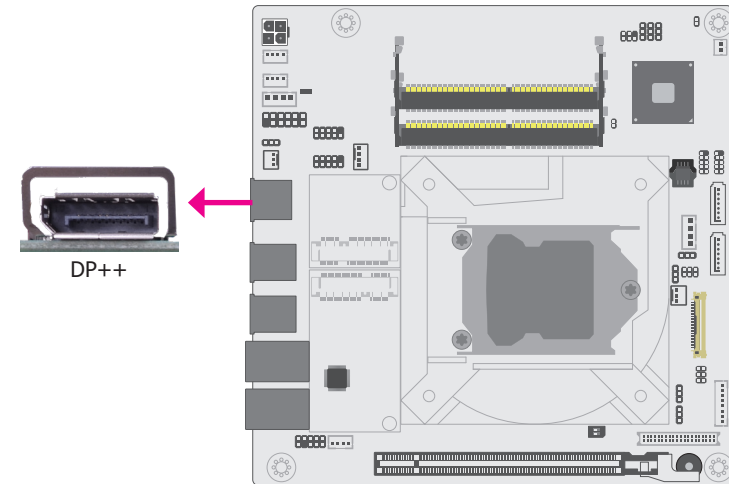

DP++ Port

The DP port is a digital display interface used to connect a display device such as a computer monitor. It is used to transmit audio and video simultaneously. The interface, which is developed by VESA, delivers higher performance features than any other digital interface.

► Rear Panel I/O Ports RJ45 LAN Ports

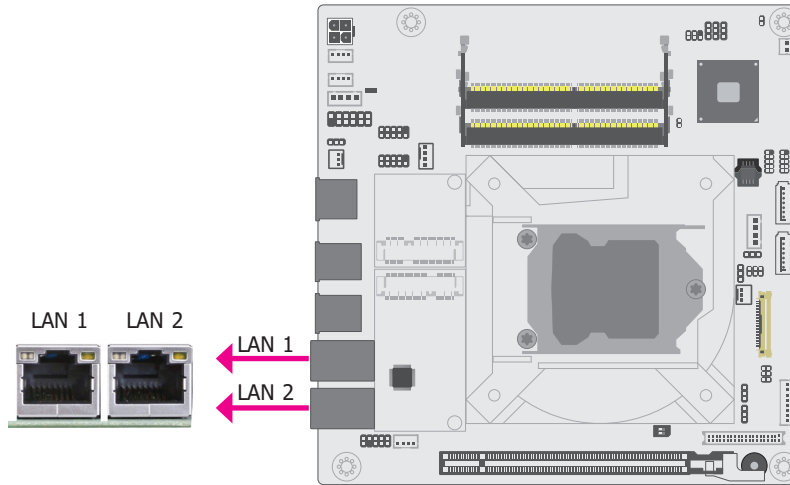

The two LAN ports allow the system board to connect to a local area network by means of a network hub.

BIOS Setting

Configure the onboard LAN ports in the Advanced menu (“ACPI Configuration” submenu) of the BIOS. Refer to the chapter 3 for more information.

Driver Installation

Install the LAN drivers. Refer to the chapter 4 for more information.

Features

- Intel® I211AT PCI Express Gigabit Ethernet controller
- Intel® I219LM PCIe with iAMT11.0 Gigabit Ethernet Phy

► Rear Panel I/O Ports USB Ports

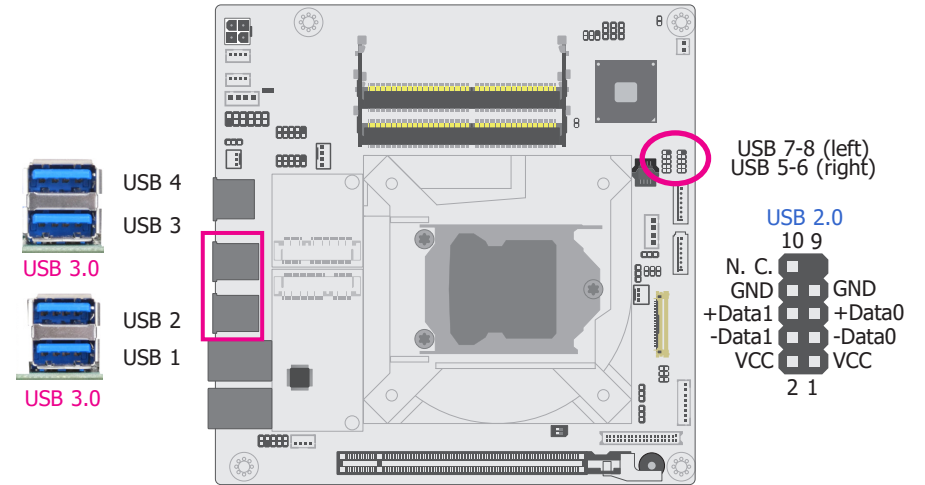

The USB device allows data exchange between your computer and a wide range of simultaneously accessible external Plug and Play peripherals. The system board is equipped with four onboard USB 3.0 ports (USB3_1-2/USB3_3-4). The 10-pin connectors allow you to connect 4 additional USB 2.0 ports (USB2_5-6/USB2_7-8). The additional USB ports may be mounted on a card-edge bracket. Install the card-edge bracket to an available slot at the rear of the system chassis and then insert the USB port cables to a connector.

Wake-On-USB Keyboard/Mouse

The Wake-On-USB Keyboard/Mouse function allows you to use a USB keyboard or USB mouse to wake up a system from the S3 (STR - Suspend To RAM) state.

BIOS Setting

Configure these onboard USB devices in the Advanced menu (“USB Configuration” submenu) of the BIOS. Refer to the chapter 3 for more information.

Driver Installation

You may need to install the proper drivers in your system operation to use the USB device. Refer to your operating system’s manual or documentation for more information.

► Internal I/O Connectors

SATA (Serial ATA) Connectors

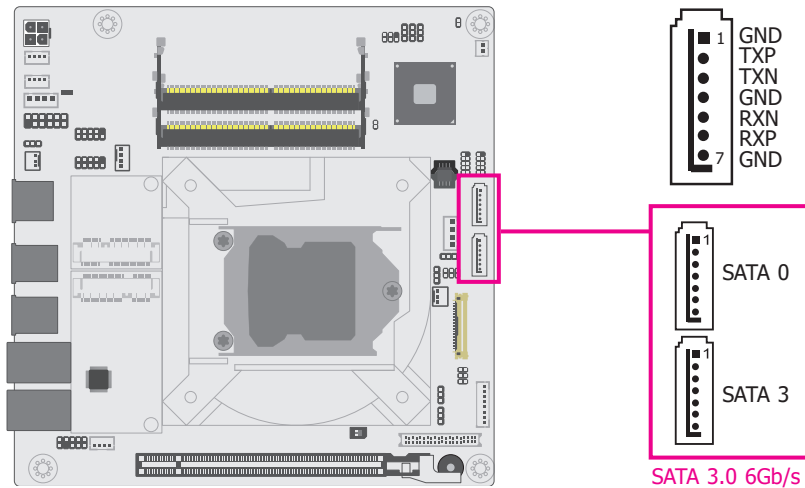

The Serial ATA connectors are used to connect Serial ATA devices. Connect one end of the Serial ATA data cable to a SATA connector and the other end to your Serial ATA device.

BIOS Setting

Configure the Serial ATA drives in the Advanced menu ("SATA Configuration" submenu) of the BIOS. Refer to the chapter 3 for more information.

Features

2 x Serial ATA 3.0 ports with data transfer rate up to 6Gb/s (SATA 0 and SATA 3)

► Internal I/O Connectors

SATA (Serial ATA) Power Connector

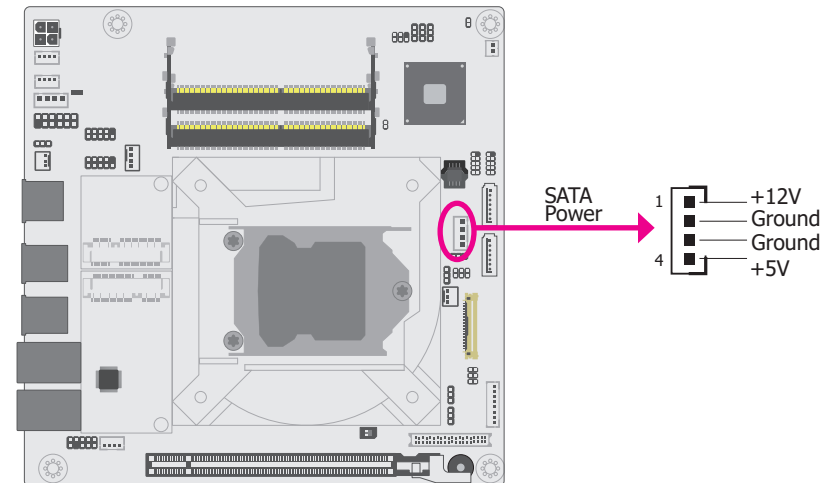

The SATA power connector supplies power to the SATA drive. Connect one end of the provided power cable to the SATA power connector and the other end to your storage device.

► Internal I/O Connectors
Digital I/O

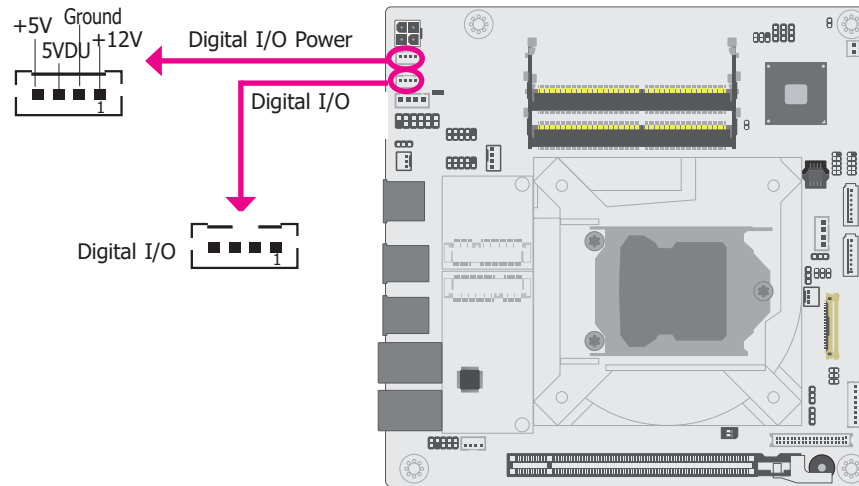

The 4-bit Digital I/O connector provides powering-on function to external devices that are connected to these connectors.

▼ Digital I/O Connector Pin assignment

Pin	Function
1	DIO0
2	DIO1
3	DIO2
4	DIO3

► Internal I/O Connectors
Cooling Fan Connectors

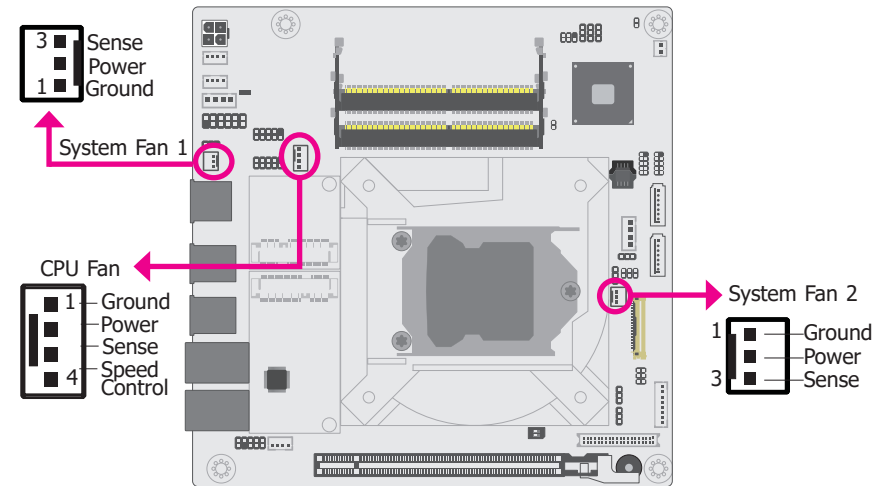

The fan connectors are used to connect cooling fans. The cooling fans will provide adequate airflow throughout the chassis to prevent overheating the CPU and system board components.

BIOS Setting

The Advanced menu ("SIO NUVOTON6106D" submenu) of the BIOS will display the current speed of the cooling fans. Refer to the chapter 3 for more information.

Internal I/O Connectors

Chassis Intrusion Connector

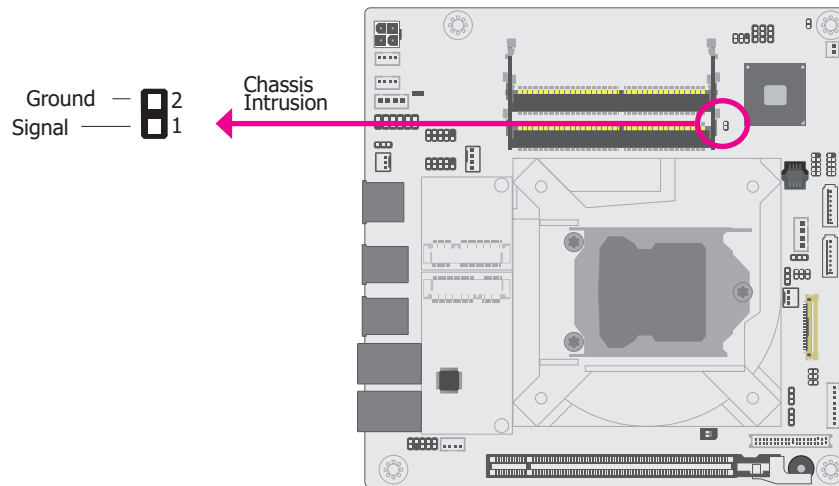

The board supports the chassis intrusion detection function. Connect the chassis intrusion sensor cable from the chassis to this connector. When the system's power is on and a chassis intrusion occurred, an alarm will sound. When the system's power is off and a chassis intrusion occurred, the alarm will sound only when the system restarts.

Internal I/O Connectors

Front Panel Connector

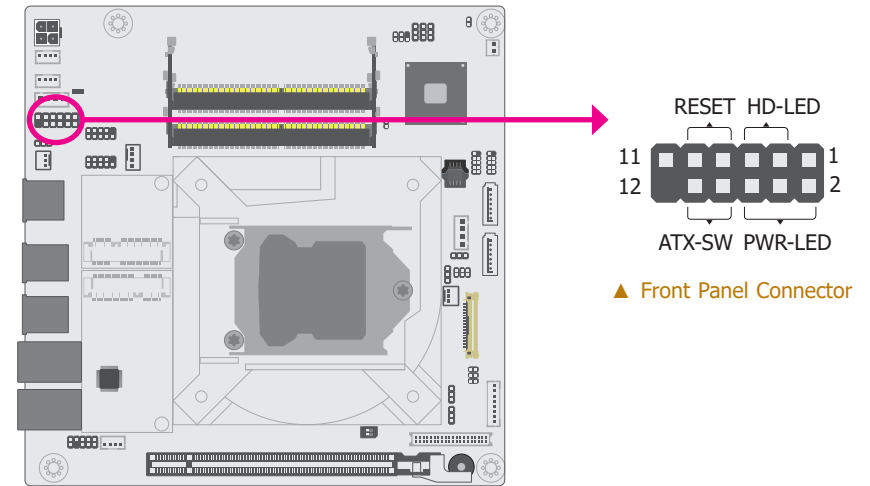

HDD-LED - Hard Disk Drive LED

Lighting of the LED indicates that the hard drive is being accessed.

RESET - Reset Switch

This switch allows you to reboot without having to power off the system.

PWR-LED - Power/Standby LED

When the system's power is on, this LED will light up. When the system is in the S1 (POS - Power On Suspend) state, it will blink at 1-second intervals. When the system is in the S3 (STR - Suspend To RAM) state, it will blink at 4-second intervals.

ATX-SW - ATX Power Switch

This switch is used to power on or off the system.

Front Panel Pin Assignment

Pin	Assignment	Pin	Assignment
1	N.C.	2	LED Power
3	HDD Power	4	LED Power
5	Signal	6	Signal
7	Ground	8	Ground
9	Signal	10	Signal
11	N.C.	12	---

► Internal I/O Connectors

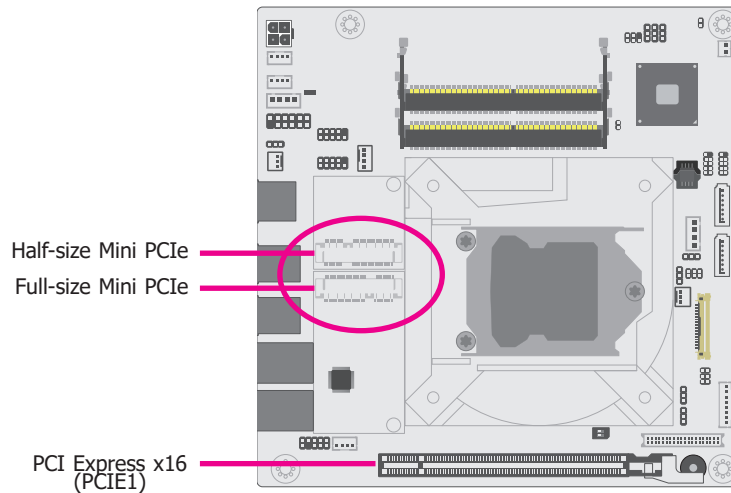
Expansion Slots**PCI Express x16 Slot**

Install a PCI Express x16 graphics card that complies to the PCI Express specifications into the PCI Express x16 slot. To install a graphics card into the x16 slot, align the graphics card to the socket and perpendicularly to the board, be cautious in aligning the locations of notch and key, and then press the card down firmly until it is completely seated. The retaining clip of the slot will close up automatically to hold the graphics card in place.

Mini PCIe Socket

The Mini PCIe socket is used to install a 52-pin Mini PCIe card. Mini PCIe card is a small form factor PCIe card with the same signal protocol, electrical definitions, and configuration definitions as the conventional PCIe. The board is layed out for one half-size and one full-size Mini PCIe slots with pre-installed standoffs.

Jumper Settings

The PCIe x16 slot can be switched between riser card and x16 signal, and the two Mini PCIe slots can be switched between PCIe signal and m-SATA signal. The settings are configured via jumpers as previously instructed in Chapter 2.

► Internal I/O Connectors ► Expansion Slots

Installing the Mini PCIe card

Before installing the Mini PCIe module into the Mini PCIe socket, please make sure that the following safety cautions are well-attended.

1. Make sure the PC and all other peripheral devices connected to it has been powered down.
2. Disconnect all power cords and cables.
3. Locate the Mini PCIe socket on the system board
4. Make sure the notch on card is aligned to the key on the socket.

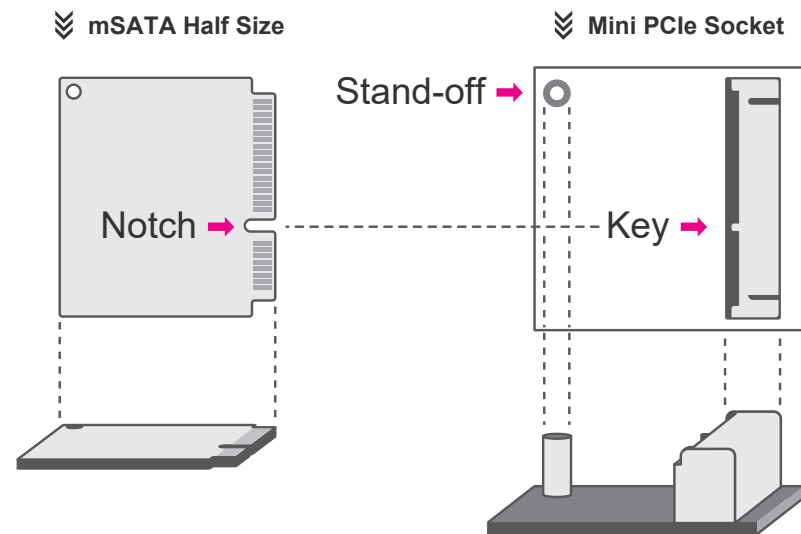

► Internal I/O Connectors ► Expansion Slots ► Installing the Mini PCIe card

Please follow the steps below to install the card into the socket.

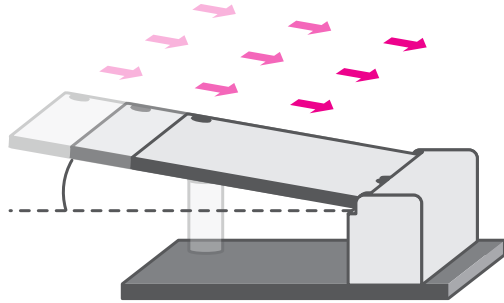

Step 1:
Insert the card into the socket at an angle while making sure the notch and key are perfectly aligned.

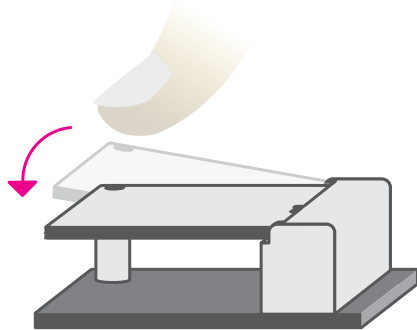

Step 2:
Press the end of the card far from the socket down until against the stand-off.

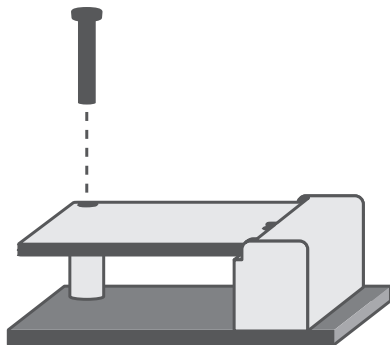

Step 3:
Screw tight the card onto the stand-off with a screw driver and a stand-off screw until the gap between the card and the stand-off closes up. The card should be lying parallel to the board when it's correctly mounted.

► Internal I/O Connectors
Standby Power LED

Standby Power LED

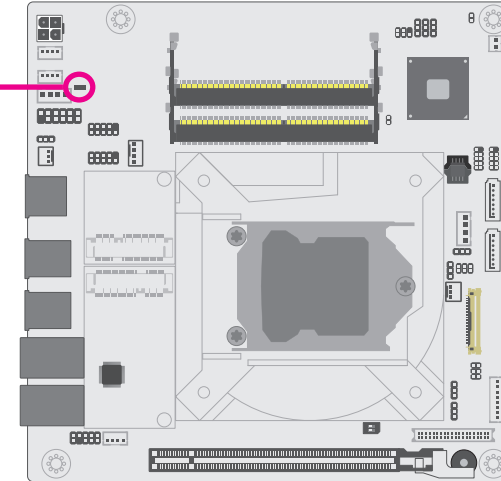

This LED will light red when the system is in the standby mode. It indicates that there is power on the system board. Power-off the PC and then unplug the power cord prior to installing any devices. Failure to do so will cause severe damage to the motherboard and components.

Internal I/O Connectors

LVDS Panel

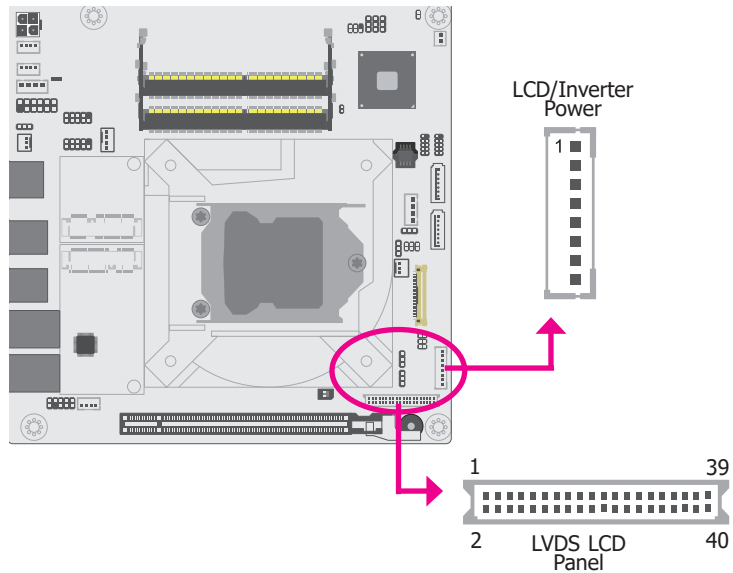

The system board allows you to connect a LCD Display Panel by means of the LVDS LCD panel connector and the LCD/Inverter power connector. These connectors transmit video signals and power from the system board to the LCD Display Panel. Refer to the right side for the pin functions of these connectors.

BIOS Setting

Configure the LCD panel in the Advanced Features submenu of the BIOS. Refer to the chapter 3 for more information.



Note:

DFI board's LVDS connector: Hirose DF13-40DP-1.25V(91)/40P/1.25mm; cable side connector: Hirose DF13-40DS-1.25C.

LVDS LCD Panel Pin Assignment

Pin	Function	Pin	Function
1	GND	2	GND
3	LVDS_Out3+ (Odd_3+)	4	LVDS_Out7+ (Even_3+)
5	LVDS_Out3- (Odd_3-)	6	LVDS_Out7- (Even_3-)
7	GND	8	GND
9	LVDS_Out2+ (Odd_2+)	10	LVDS_Out6+ (Even_2+)
11	LVDS_Out2- (Odd_2-)	12	LVDS_Out6- (Even_2-)
13	GND	14	GND
15	LVDS_Out1+ (Odd_1+)	16	LVDS_Out5+ (Even_1+)
17	LVDS_Out1- (Odd_1-)	18	LVDS_Out5- (Even_1-)
19	GND	20	GND
21	LVDS_Out0+ (Odd_0+)	22	LVDS_Out4+(Even_0+)
23	LVDS_Out0- (Odd_0-)	24	LVDS_Out4- (Even_0-)
25	GND	26	GND
27	LVDS_CLK1+ (Odd_CLK+)	28	LVDS_CLK2+ (Even_CLK+)
29	LVDS_CLK1- (Odd_CLK-)	30	LVDS_CLK2- (Even_CLK-)
31	GND	32	GND
33	LVDS_DDC_CLK	34	NC
35	LVDS_DDC_DATA	36	+3.3V
37	Panel Power	38	Panel Power
39	Panel Power	40	Panel Power

LCD/Inverter Power Pin Assignment

Pin	Function	Pin	Function
1	GND	5	+3.3V
2	GND	6	Panel Backlight On/Off Control
3	Panel Inverter Brightness Voltage Control	7	12V (default)/5V
4	Panel Power	8	12V (default)/5V

Internal I/O Connectors

SMBus Connector

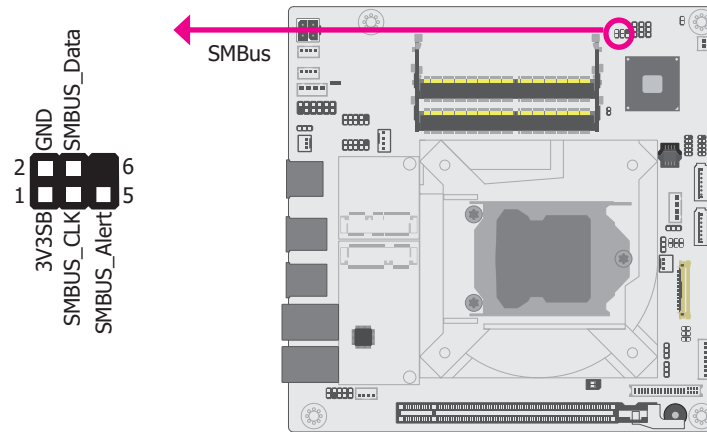

The SMBus (System Management Bus) connector is used to connect SMBus devices. It is a multiple device bus that allows multiple chips to connect to the same bus and enable each one to act as a master by initiating data transfer.

Internal I/O Connectors

Speaker Connector

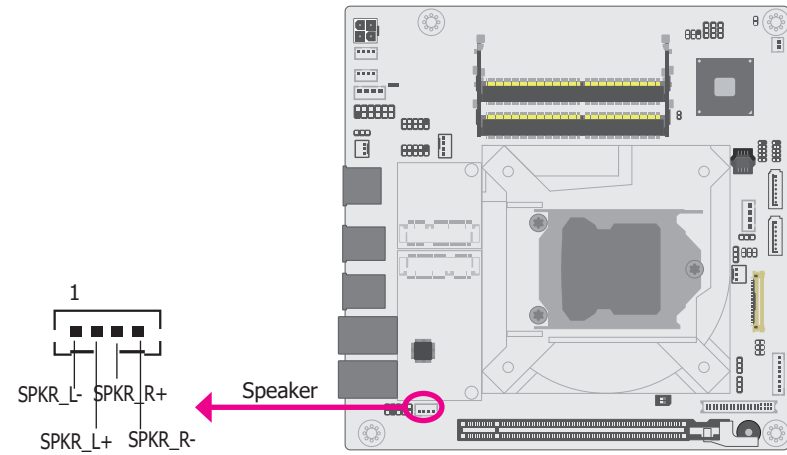

The speaker connector is used to connect external speakers.

► Internal I/O Connectors

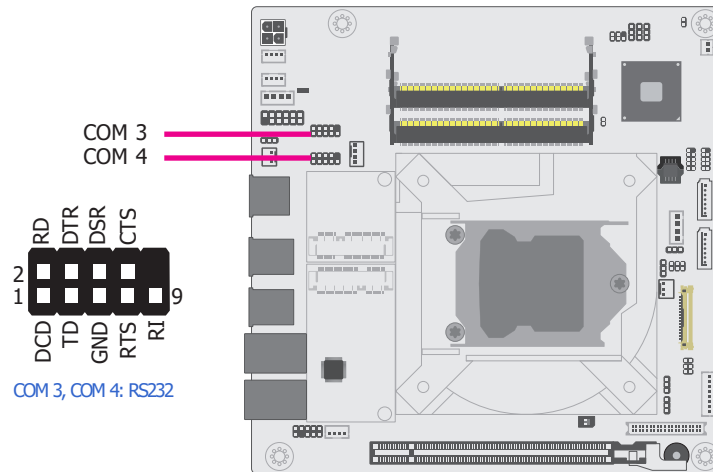
COM (Serial) Ports

COM 3 and COM 4 are RS232 serial ports.

The serial ports are asynchronous communication ports with 16C550A-compatible UARTs that can be used with modems, serial printers, remote display terminals, and other serial devices.

Connecting External Serial Ports

Your COM port may come mounted on a card-edge bracket. Install the card-edge bracket to an available slot at the rear of the system chassis then insert the serial port cable to the COM connector. Make sure the colored stripe on the ribbon cable is aligned with pin 1 of the COM connector.

BIOS Setting

Configure the serial COM ports in the Advanced menu ("SIO NUVOTON6106D" submenu) of the BIOS. Refer to the chapter 3 for more information.

► Internal I/O Connectors

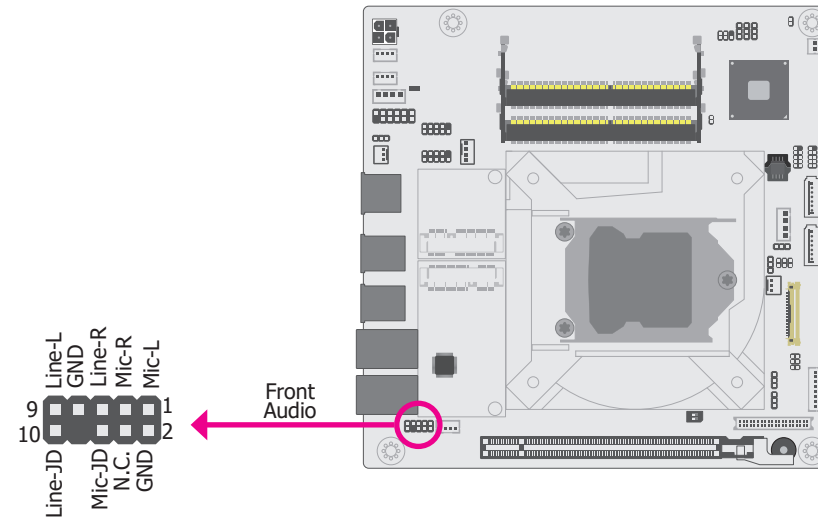
Front Audio Connector**Front Audio**

The front audio connector allows you to connect to the line-out and mic-in jacks that are at the front panel of your system.

Driver Installation

Install the audio driver. Refer to the chapter 4 for more information.

► Internal I/O Connectors
Power ATX Mode

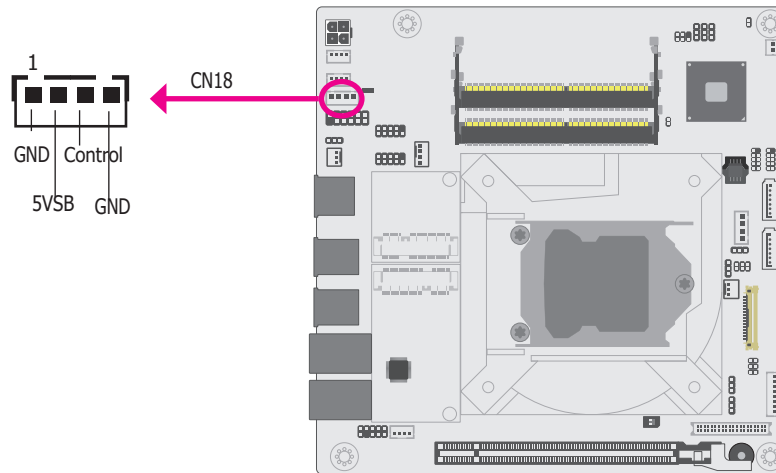

Depending on customer's power supply requirement and application, both CN18 and CN2 (DC-in) have to be connected to supply power to the system.

► Internal I/O Connectors
15~36V DC-in

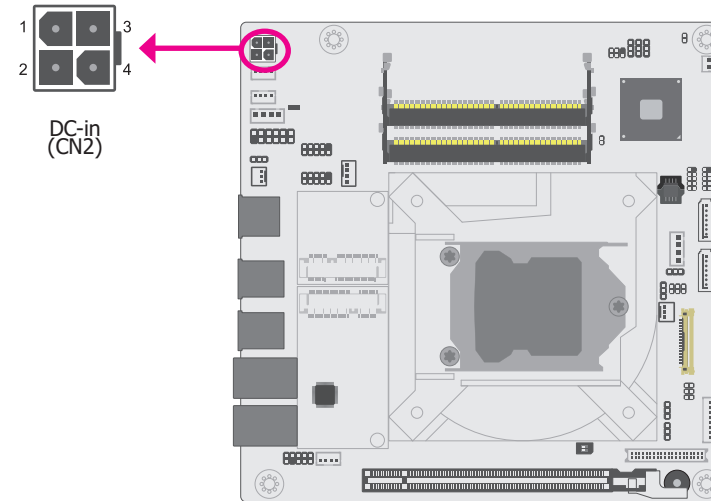

This DC-in connector is a 4-pin vertical connector and is considered as a low power solution. Connect a DC power cord to this connector. Using a voltage more than the recommended range may fail to boot the system or cause damage to the system board.

► Internal I/O Connectors

eDP Connector

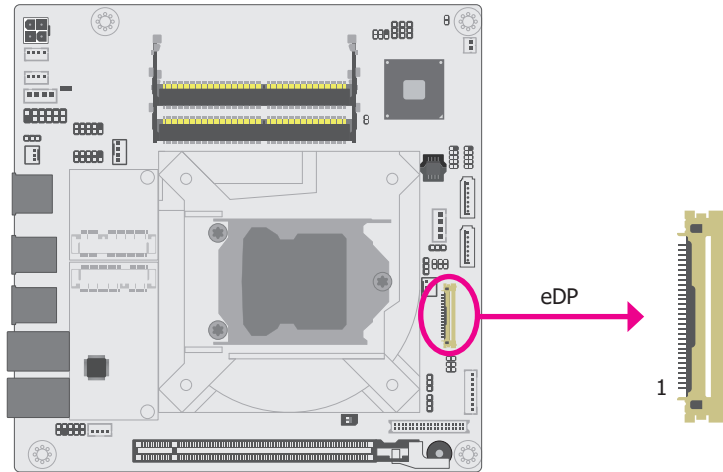

The eDP connector is an embedded display port which has advanced power-saving features to connect a display device to transmit digital communication of audio and video signals. The table on the right side indicates the pin definitions of the eDP connector.

**Note:**

DFI board's eDP connector: I-PEX 20455-040E-76 (40 Pin, 90D, 0.5mm).

▼ eDP Pin Assignment

Pin	Function	Pin	Function
1	NA	21	eDP Panel Power
2	GND	22	NA
3	eDP_LANE3-	23	GND
4	eDP_LANE3+	24	GND
5	GND	25	GND
6	eDP_LANE2-	26	GND
7	eDP_LANE2+	27	eDP_HPDP
8	GND	28	GND
9	eDP_LANE1-	29	GND
10	eDP_LANE1+	30	GND
11	GND	31	GND
12	eDP_LANE0-	32	eDP_Backlight On/Off Control
13	eDP_LANE0+	33	eDP Inverter Brightness Voltage Control
14	GND	34	NA
15	eDP_AUX+	35	NA
16	eDP_AUX-	36	Inverter Power
17	GND	37	Inverter Power
18	eDP Panel Power	38	Inverter Power
19	eDP Panel Power	39	Inverter Power
20	eDP Panel Power	40	NA

► Internal I/O Connectors

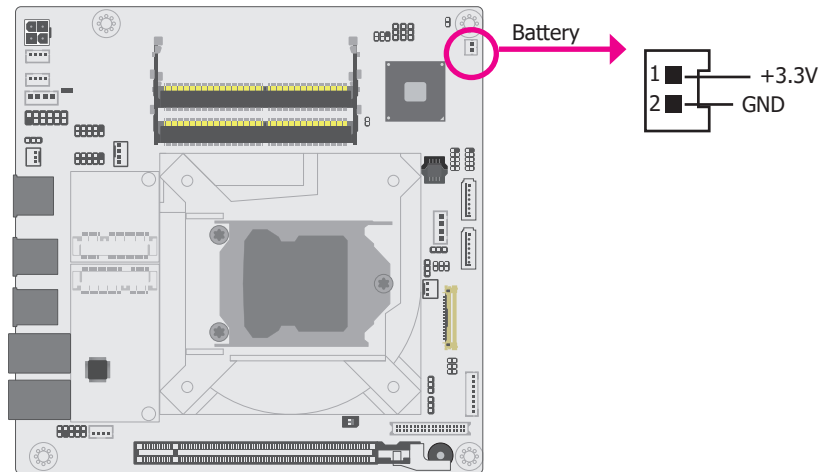
Battery

The lithium ion battery powers the real-time clock and CMOS memory. It serves as an auxiliary source of power when the main power source is lost.

Safety Measures

- There exists explosion hazard if the battery is incorrectly installed.
- Replace only with the same or equivalent type recommended by the manufacturer.
- Dispose of used batteries according to local ordinances.

Chapter 3 - BIOS Setup

► Overview

The BIOS is a program that takes care of the basic level of communication between the CPU and peripherals. It contains codes for various advanced features found in this system board. The BIOS allows you to configure the system and save the configuration in a battery-backed CMOS so that the data retains even when the power is off. In general, the information stored in the CMOS RAM of the EEPROM will stay unchanged unless a configuration change has been made such as a hard drive replaced or a device added.

It is possible that the CMOS battery will fail causing CMOS data loss. If this happens, you need to install a new CMOS battery and reconfigure the BIOS settings.



Note:

The BIOS is constantly updated to improve the performance of the system board; therefore the BIOS screens in this chapter may not appear the same as the actual one. These screens are for reference purpose only.

Default Configuration

Most of the configuration settings are either predefined according to the Load Optimal Defaults settings which are stored in the BIOS or are automatically detected and configured without requiring any actions. There are a few settings that you may need to change depending on your system configuration.

Entering the BIOS Setup Utility

The BIOS Setup Utility can only be operated from the keyboard and all commands are keyboard commands. The commands are available at the right side of each setup screen.

The BIOS Setup Utility does not require an operating system to run. After you power up the system, the system logo appears on the screen and the memory count begins. After the memory test, the message "Press DEL to run setup" will appear on the screen. If the message disappears before you respond, restart the system or press the "Reset" button. You may also restart the system by pressing the <Ctrl> <Alt> and keys simultaneously.

Legends

Keys	Function
Right and Left arrows	Move the cursor left or right to select a menu.
Up and Down arrows	Moves the cursor up or down between submenu or fields.
<Esc>	Exit to the BIOS Setup Utility.
<F5>	Next value/option of the highlighted field
<F6>	Previous value/option of the highlighted fieldfield.
<F1>	Display general help
<F9>	Optimized defaults
<F10>	Save and Exit
<Enter>	Enter the highlighted submenu

Scroll Bar

When a scroll bar appears to the right of the setup screen, it indicates that there are more available fields not shown on the screen. Use the up and down arrow keys to scroll through all the available fields.

Submenu

When "►" appears on the left of a particular field, it indicates that a submenu which contains additional options are available for that field. To display the submenu, move the highlight to that field and press <Enter>.

► Main

The Main menu is the first screen that you will see when you enter the BIOS Setup Utility.

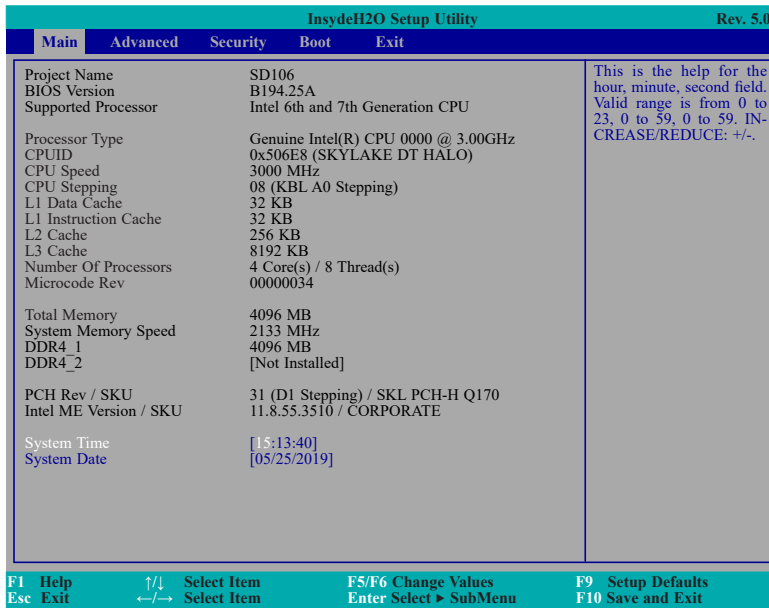

System Time

The time format is <hour>, <minute>, <second>. The time is based on the 24-hour military-time clock. For example, 1 p.m. is 13:00:00. Hour displays hours from 00 to 23. Minute displays minutes from 00 to 59. Second displays seconds from 00 to 59.

System Date

The date format is <month>, <date>, <year>. Month displays the month, from 01 to 12. Date displays the date, from 01 to 31. Year displays the year, from 2000 to 2099.

► Advanced

The Advanced menu allows you to configure your system for basic operation. Some entries are defaults required by the system board, while others, if enabled, will improve the performance of your system or let you set some features according to your preference.



Important:

Setting incorrect field values may cause the system to malfunction.

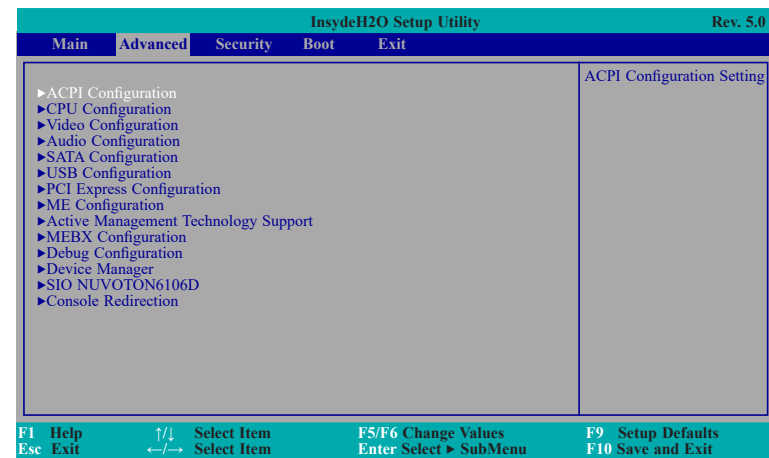

► Advanced

ACPI Configuration

This section is used to configure the system ACPI parameters.

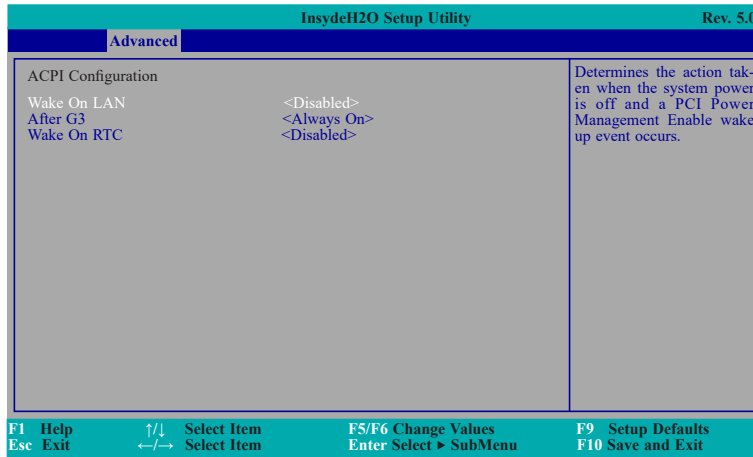
**Wake On LAN**

This field is used to enable or disable the LAN signal to wake up the system.

After G3

This field is to specify what state to go when power is re-applied after a power failure (G3 state).

Always On The system working state.

Always Off Off, except for trickle current to devices such as the power button.

Wake On RTC

Automatically power the system on at a particular time every day from the Real-time clock battery.

Wake up time

When Wake On RTC is set to enabled, specify the wake up time of the day: <hour> (00~23), <minute> (00~59), <second> (00~59).

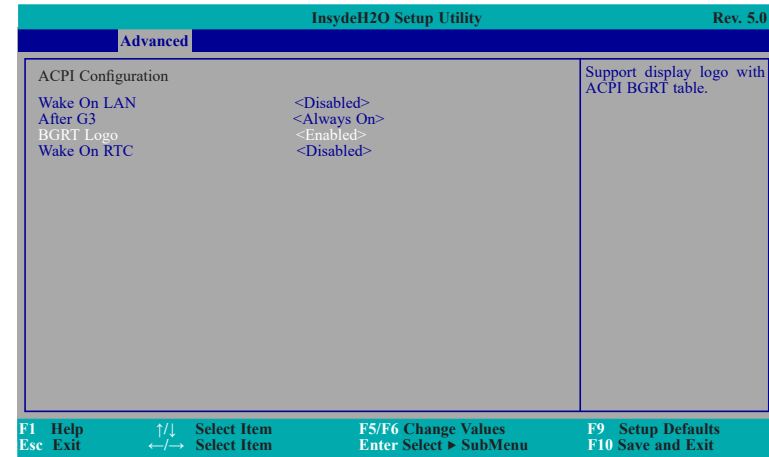
**BGRT Logo**

This field is used to enable or disable to support display logo with ACPI BGRT table.

**Note:**

Under Dual Boot Type or UEFI Boot Type mode, if Quiet Boot is set to enabled, BGRT Logo field will appear for configuration. Refer to the Boot menu for more information.

► Advanced

CPU Configuration

This section is used to configure the CPU.

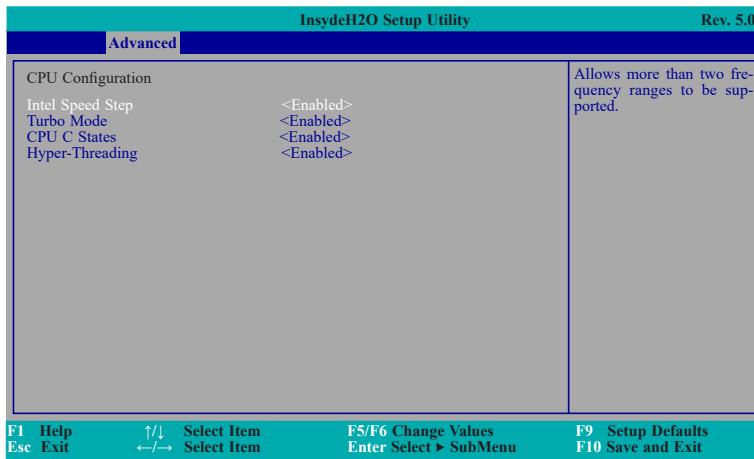
**Intel Speed Step**

This field is used to enable or disable the Intel Enhanced SpeedStep Technology. If enabled, Turbo Mode will appear for configuration.

Turbo Mode

Enable or disable the turbo mode.

CPU C States

Enable or disable the CPU Power Management.

Hyper-Threading

Enables this field for Windows XP and Linux which are optimized for Hyper-Threading technology. Select disabled for other OSes not optimized for Hyper-Threading technology. When disabled, only one thread per enabled core is enabled.

► Advanced

Video Configuration

This section configures the video settings.

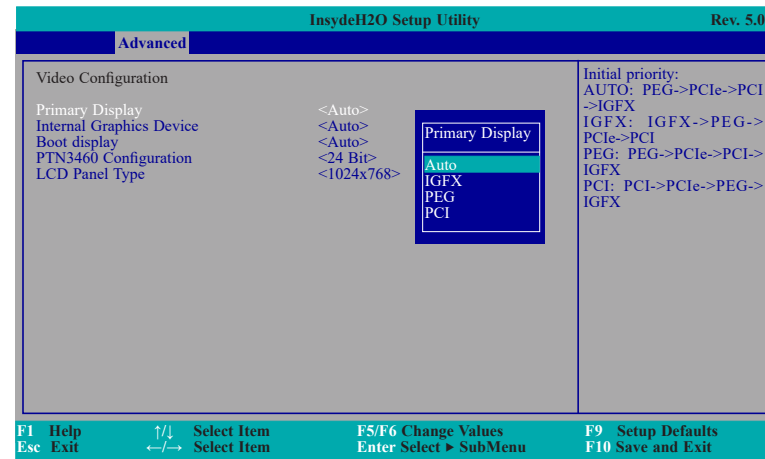
**Primary Display**

Set the initial priority.

Internal Graphics Device

Keep IGFX enabled or disabled based on the setup options.

Boot display

Set the display device combination.

**Note:**

To control "Primary Display" & "Boot display", first go to "Boot" menu and select different "Boot Type".

Boot Type : Legacy Boot Type -> Hide Primary Display & Show Boot display

Boot Type : UEFI Boot Type -> Show Primary Display & Hide Boot display

Boot Type : Dual Boot Type -> Show Primary Display & Show Boot display

► **Advanced** ► **Video Configuration**

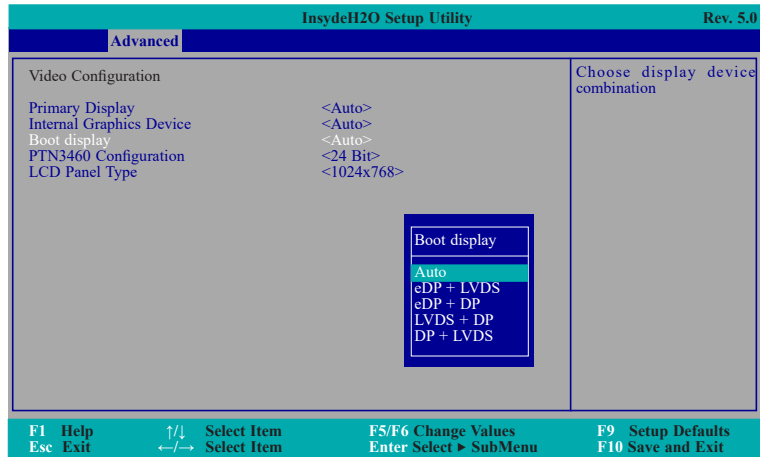

PTN3460 Configuration

Select the LCD panel color depth: 18 Bit, 24 Bit, 36 Bit or 48 Bit.

LCD Panel Type

Please check the specifications of your LCD monitor. Select the type of LCD panel connected to the system's LCD connector: VBIOS Default, 800x480, 800x600, 1024x768, 1366x768, 1280x1024 or 1920x1080.

► **Advanced**

Audio Configuration

This section is used to configure the audio settings.

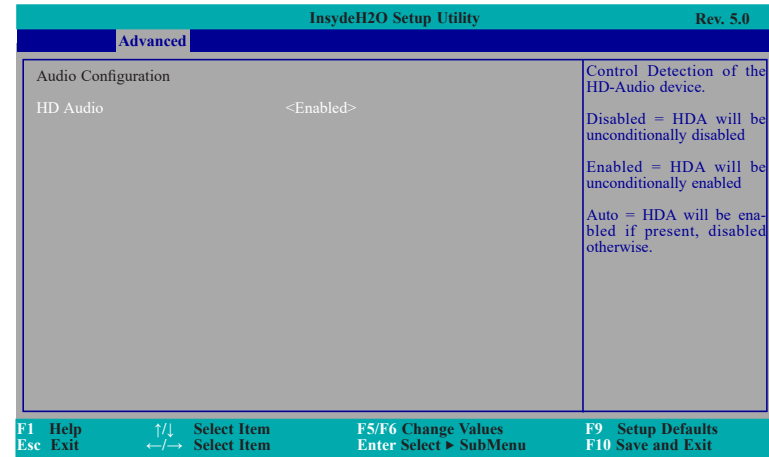

HD Audio

Control the detection of the HD-Audio device.

Disabled HDA will be unconditionally disabled.

Enabled HDA will be unconditionally enabled.

Auto HDA will be enabled if present, disabled otherwise.

► Advanced

SATA Configuration

This section is designed to select the SATA controller and the type of hard disk drive which are installed in your system unit.

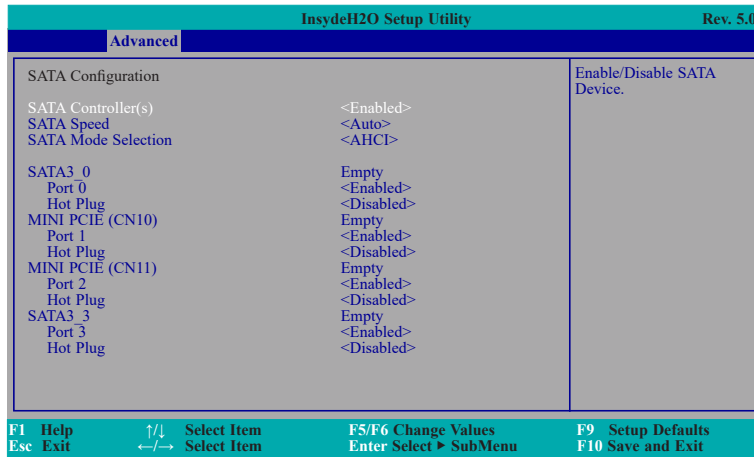
**SATA Controller(s)**

This field is used to enable or disable Serial ATA devices.

SATA Speed

This field is used to select SATA speed generation limit: Auto, Gen1, Gen2 or Gen3.

SATA Mode Selection

The mode selection determines how the SATA controller(s) operates.

AHCI This option allows the Serial ATA devices to use AHCI (Advanced Host Controller Interface).

RAID This option allows you to create RAID or Intel Matrix Storage configuration on Serial ATA devices.

Port 0, 1, 2, 3 and Hot Plug

These fields are used to enable or disable the serial ATA port and its hot plug.

► Advanced

USB Configuration

This section is used to configure the parameters of the USB device.

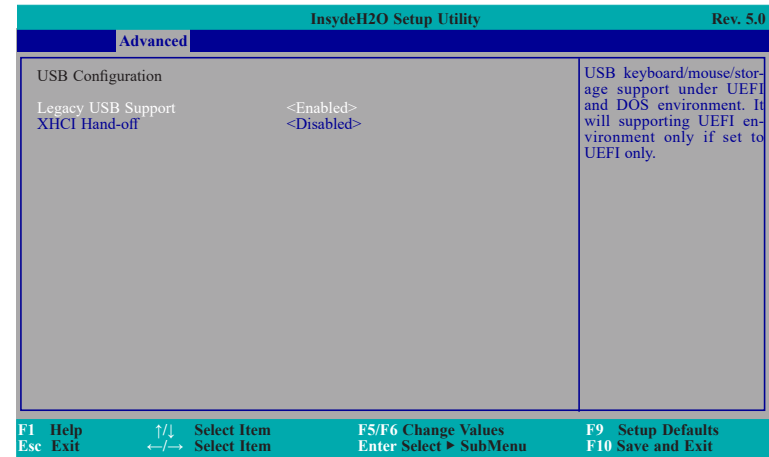
**Legacy USB Support**

Disabled Disable USB keyboard/mouse/storage support under UEFI and DOS environment.

Enabled Enable USB keyboard/mouse/storage support under UEFI and DOS environment.

UEFI Only Enable USB keyboard/mouse/storage support under UEFI environment.

XHCI Hand-off

Enable or disable to clear XHCI controller ownership change SMI bit by BIOS.

► **Advanced****PCI Express Configuration**

This section configures settings relevant to PCI Express root ports.

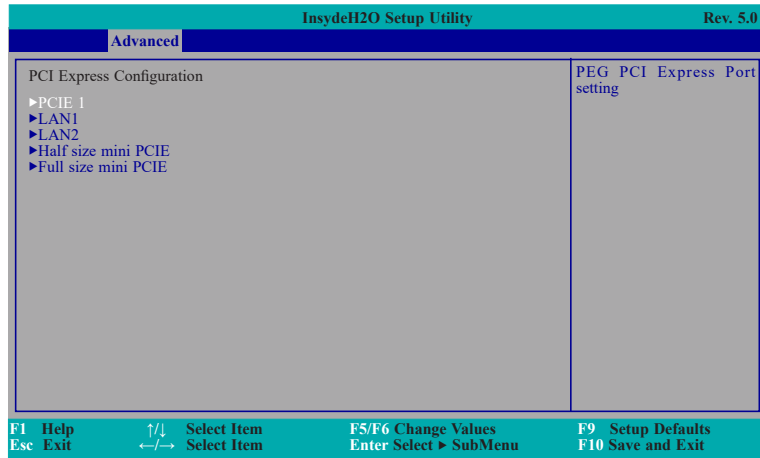
► **Advanced** ► **PCI Express Configuration****► PCIE 1/LAN1/LAN2/Half size mini PCIE/Full size mini PCIE**

This field is used to enable or disable the PCI Express Root Port.

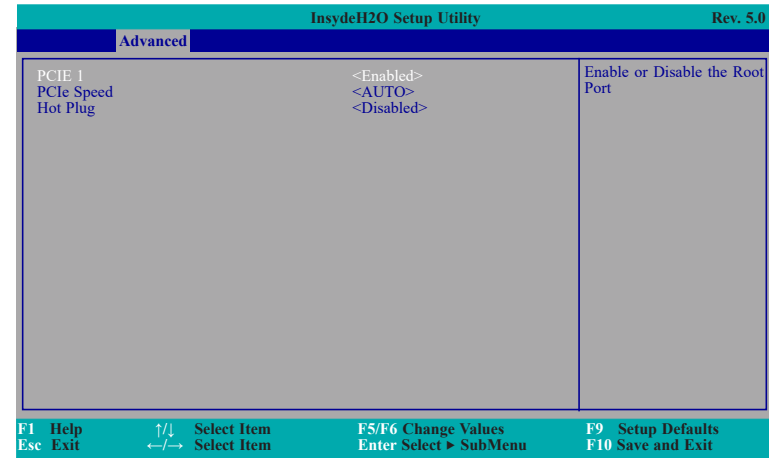
**PCIe Speed**

Select the speed of the PCI Express Root Port: Auto, Gen1, Gen2 or Gen3.

Hot Plug

This field is used to enable or disable the PCI Express Hot Plug.

► **Advanced****ME Configuration**

This section configures settings relevant to flash ME region.

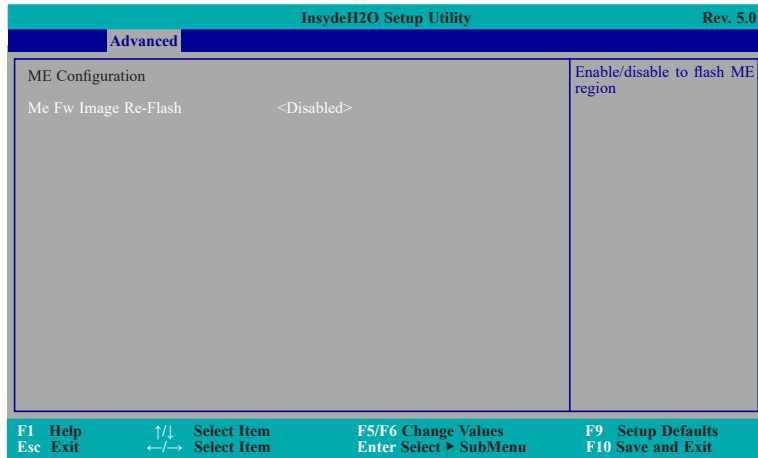
**Me Fw Image Re-Flash**

This field is used to enable or disable the flash ME region.

► **Advanced****Active Management Technology Support**

The section allows users to enable or disable the Intel® Active Management Technology (Intel® AMT). Please refer to **Chapter 6** for more information.

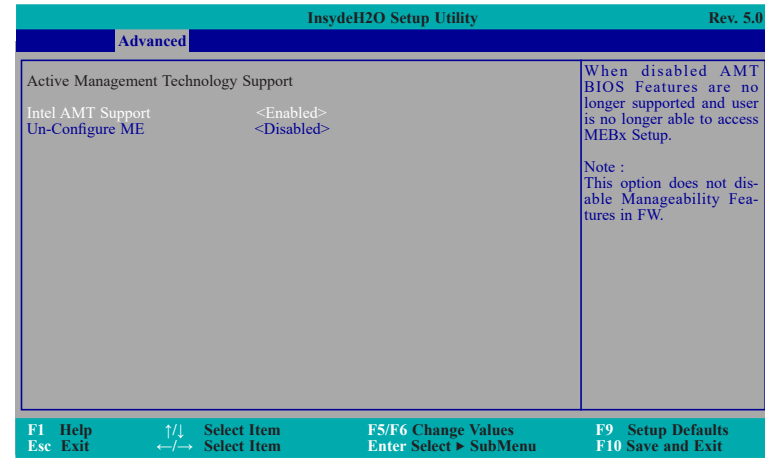
**Intel AMT Support**

This field is used to enable or disable Intel® Active Management Technology.

Un-Configure ME

This field is used to enable or disable to un-configure ME with resetting MEBX password to default.

► **Advanced****MEBX Configuration**

Configure Intel® Active Management Technology (Intel® AMT) in the Intel® Management Engine BIOS Extension (MEBX) setup menu. Please refer to **Chapter 6** for more information.

► **Advanced****Debug Configuration**

This section configures Debug setting.

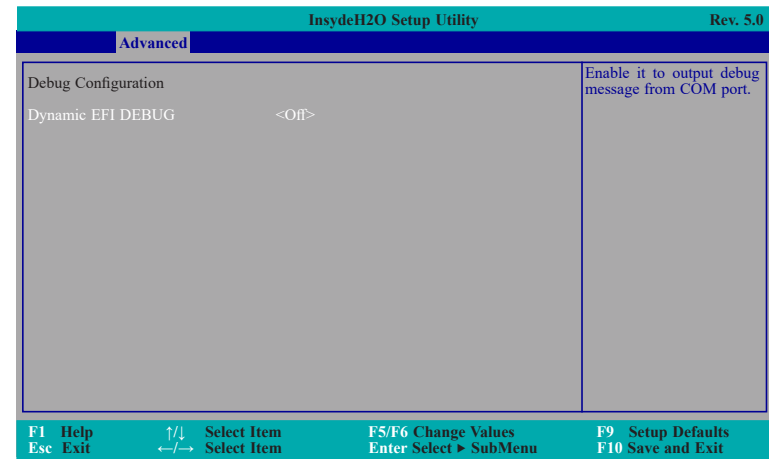
**Dynamic EFI DEBUG**

This field is used to turn on or off the function to output debug message from COM port. If set to on, relevant EFI debug configuration will show up.

► **Advanced** ► **Debug Configuration**

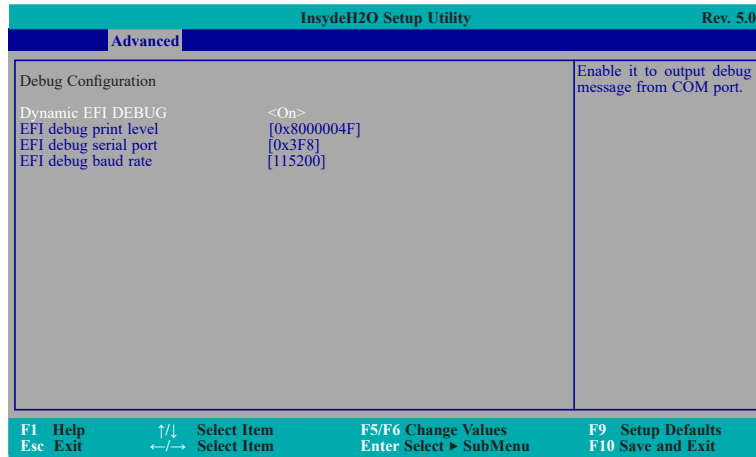

EFI debug print level

Enter numeric value for EFI Debug Print Level and default is 0x8000004F.

EFI debug serial port

Enter serial port to output EFI debug message and default is 0x3F8.

EFI debug baud rate

Enter baud rate to output EFI debug message and default is 115200.

► **Advanced**
Device Manager

The section configures UEFI device with option ROM, such as LAN card, etc.

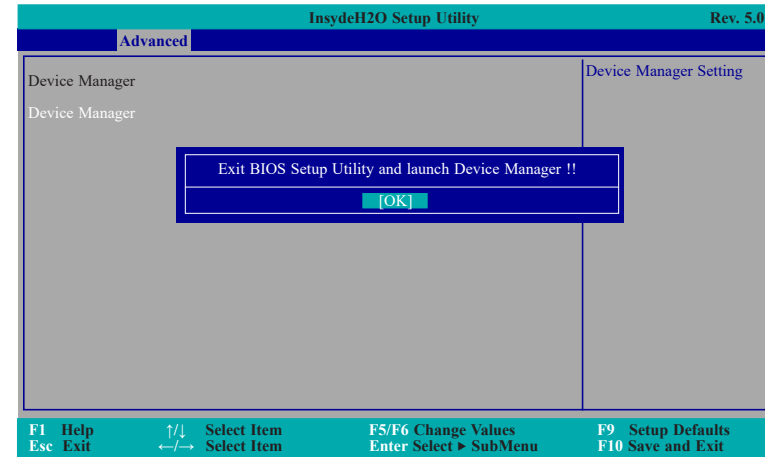

► Advanced

SIO NUVOTON6106D

This section configures the system super I/O chip parameters.

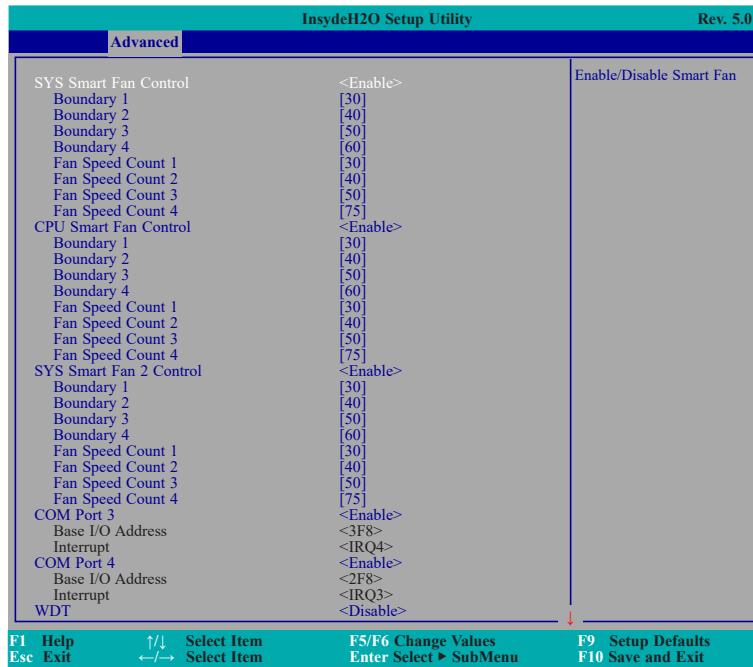
**Note:**

When SYS Smart Fan Control, CPU Smart Fan Control, and SYS Smart Fan 2 Control are disabled, "Fix Fan Speed Count" will appear for configuration.

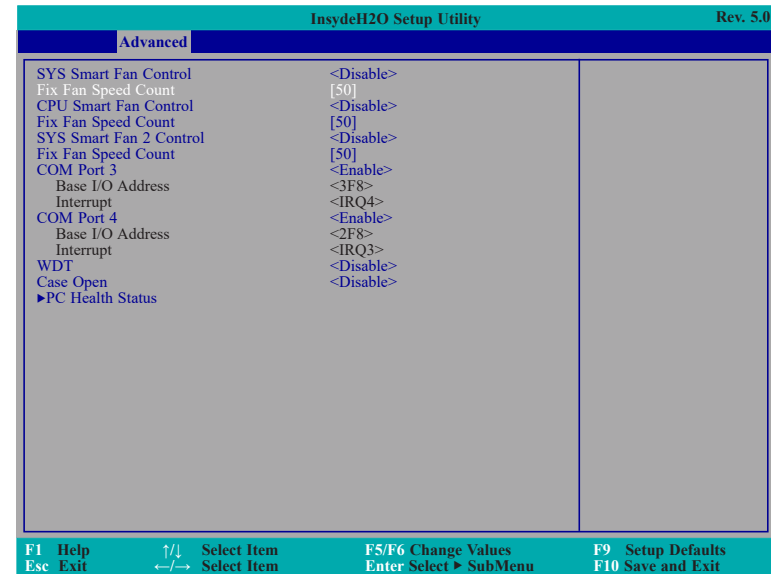
**SYS Smart Fan, CPU Smart Fan, SYS Smart Fan 2 Control**

Enable or disable the system/CPU smart fan/fan 2.

Boundary 1 to Boundary 4

Set the boundary temperatures that determine the operation of the fan with different fan speeds accordingly. For example, when the system or the CPU temperature reaches boundary temperature 1, the system or CPU fan should be turned on and operate at the designated speed. The range is from 0-127°C.

Fan Speed Count 1 to Fan Speed Count 4

Set the fan speed. The range is from 1-100% (full speed).

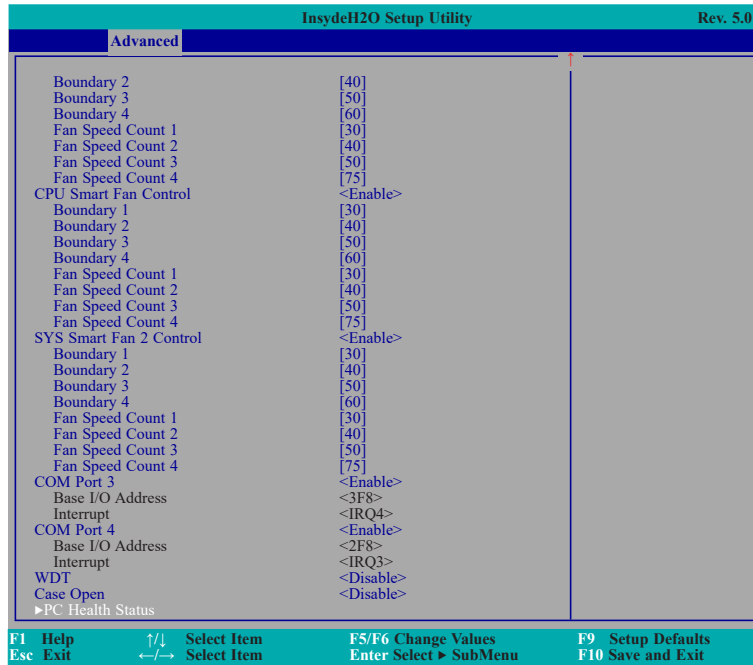

COM Port 3/4

Configure the settings to use the serial port.

- Disable** No configuration
- Enable** User configuration

WDT

Enable or disable the watchdog function. A counter will appear if you select to enable WDT. Input any value between 1 to 255 seconds.

Case Open

Enable or disable the case open detection function.

► PC Health Status

This section displays the PC health status.

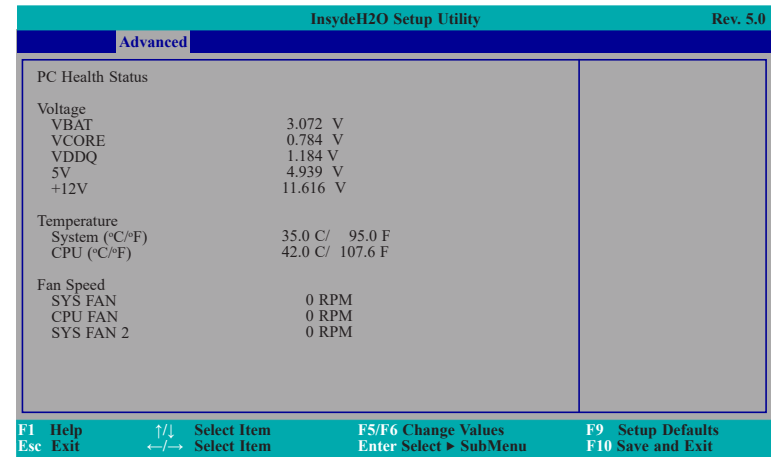

► **Advanced****Console Redirection**

This section configures settings relevant to console redirection.

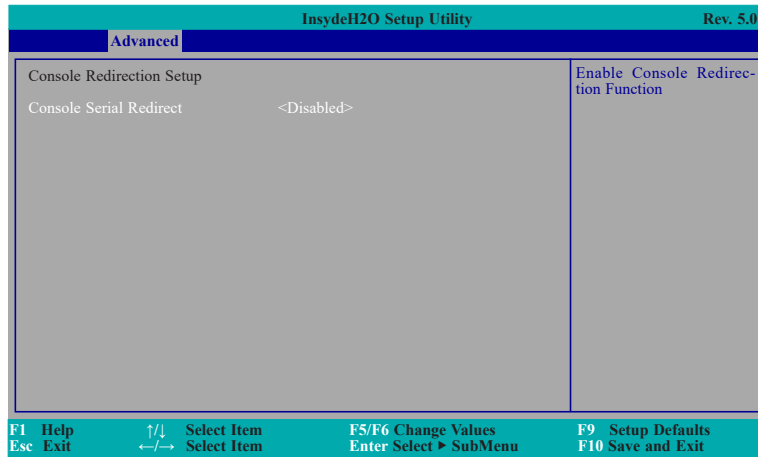
**Console Serial Redirect**

This field is used to enable or disable the console serial redirection function.

When Console Serial Redirect is set to enabled, the screen will appear like below:

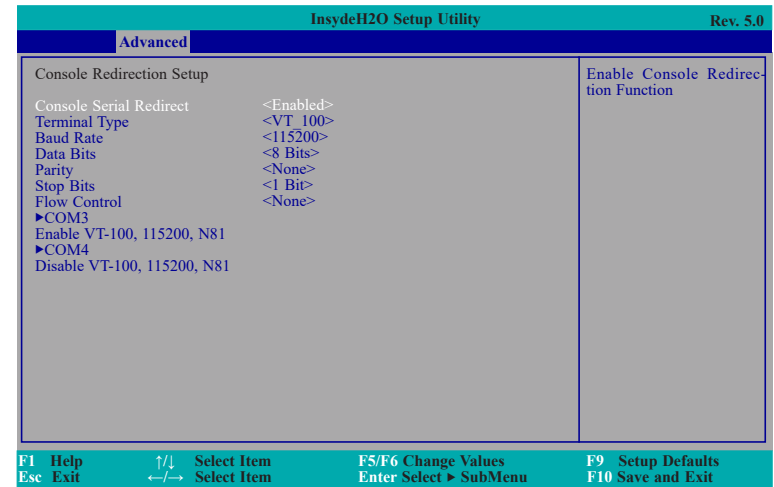
**Terminal Type**

Select terminal type: VT_100, VT_100+, VT_UTF8 or PC_ANSI.

Baud Rate

Select baud rate: 115200, 57600, 38400, 19200, 9600, 4800, 2400 or 1200.

Data Bits

Select data bits: 7 bits or 8 bits.

Parity

Select parity bits: none, even or odd.

Stop Bits

Select stop bits: 1 bit or 2 bits.

Flow Control

Select flow control type: none, RTS/CTS or XON/XOFF.

► **Advanced** ► **Console Redirection**

► **COM3/4**

When UseGlobalSetting is set to disabled, the screen will appear like below:

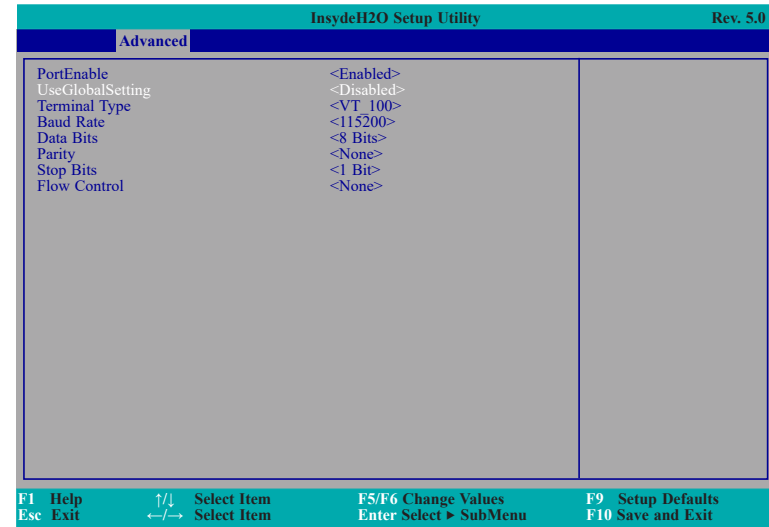
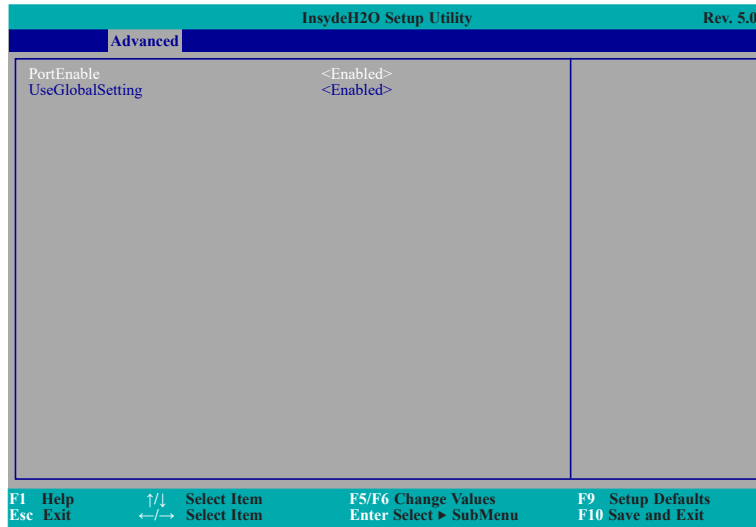

PortEnable

This field is used to enable or disable the COM port to redirect the console.

UseGlobalSetting

This field is to enable or disable to use global setting. When enabled the global setting, setting of the COM port will be the same as those in Console Redirection section. When disabled the global setting, setting of the COM port can be configured independently in this section.

► Security

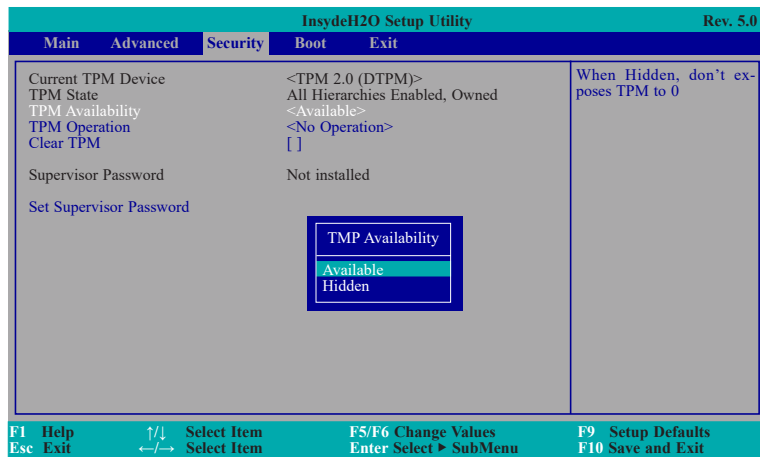

TPM Availability

Set the TPM availability.

TPM Operation

Select one of the supported operation to change TPM2 state.

Clear TPM

Remove all TPM context associated with a specific owner.

Set Supervisor Password

Set the supervisor's password and the length of the password must be greater than one character.

► Boot

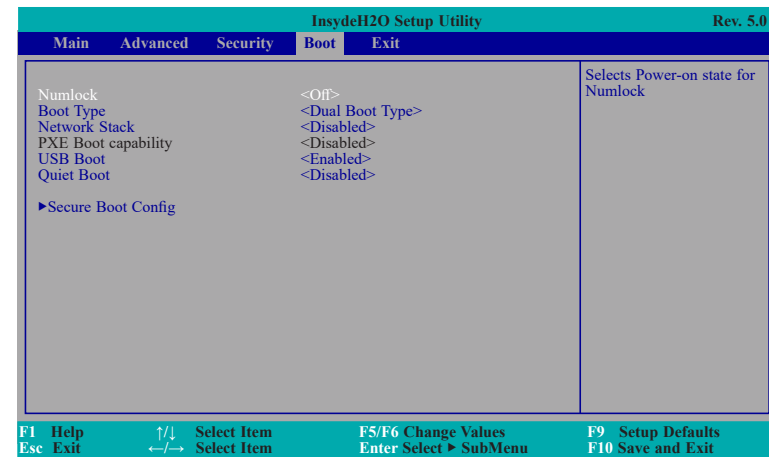

Numlock

Select the power-on state for numlock.

Boot Type

Select the boot type. The options are UEFI Boot Type, Legacy Boot Type or Dual Boot Type.

If you select "UEFI Boot Type" or "Dual Boot Type", the "Network Stack", "PXE Boot capability", "USB Boot" and "Quiet Boot" will show up.

If you select "Legacy Boot Type", "PXE Boot to LAN", "USB Boot" and "Quiet Boot" will show up.



Note:

If the boot type is set to UEFI, the method for RAID volume creation will be different. Please refer to Chapter 5 - RAID for more information.

Network Stack

This field is used to enable or disable network stack.

PXE Boot capability

Disabled Support Network Stack

UEFI IPv4/IPv6

Legacy Legacy PXE OPROM only

► **Boot****PXE Boot to LAN**

Disable or enable PXE boot to LAN.

USB Boot

Enable or disable booting to USB boot devices.

Quiet Boot

Enable or disable booting in text mode.

► **Secure Boot Config**

User can choose to enable UEFI secure boot and restore factory default key or clear all secure boot key.

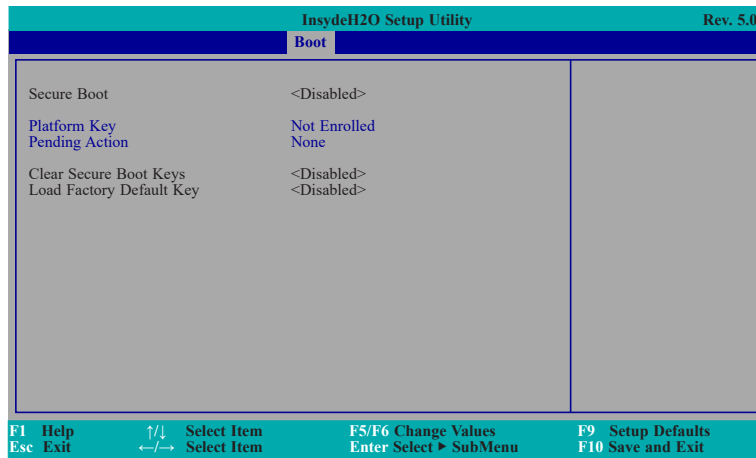
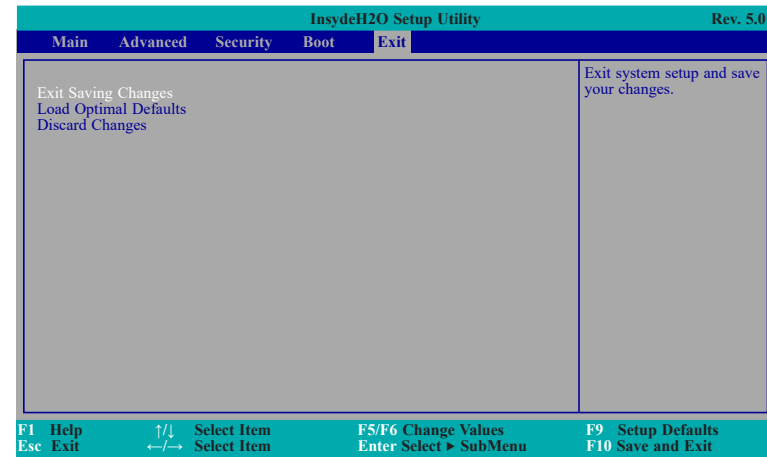
► **Exit****Exit Saving Changes**

Select Yes and then press <Enter> to exit the system setup and save your changes.

Load Optimal Defaults

Select YES and then press <Enter> to load optimal defaults.

Discard Changes

Select YES and then press <Enter> to exit the system setup without saving your changes.

► Updating the BIOS

To update the BIOS, you will need the new BIOS file and a flash utility. Please contact technical support or your sales representative for the files and specific instructions about how to update BIOS with the flash utility. For updating Insyde BIOS in UEFI mode, you may refer to the how-to video at <https://www.dfi.com/tw/knowledge/video/31>.

► Notice: BIOS SPI ROM

1. The Intel® Management Engine has already been integrated into this system board. Due to the safety concerns, the BIOS (SPI ROM) chip cannot be removed from this system board and used on another system board of the same model.
2. The BIOS (SPI ROM) on this system board must be the original equipment from the factory and cannot be used to replace one which has been utilized on other system boards.
3. If you do not follow the methods above, the Intel® Management Engine will not be updated and will cease to be effective.

**Note:**

- a. You can take advantage of flash tools to update the default configuration of the BIOS (SPI ROM) to the latest version anytime.
- b. When the BIOS IC needs to be replaced, you have to populate it properly onto the system board after the EEPROM programmer has been burned and follow the technical person's instructions to confirm that the MAC address should be burned or not.

Chapter 4 - Supported Software

The DVD that came with the system board contains drivers, utilities and software applications required to enhance the performance of the system board.

Insert the DVD into a DVD-ROM drive. The autorun screen (Mainboard Utility DVD) will appear. If after inserting the DVD, "Autorun" did not automatically start (which is, the Mainboard Utility DVD screen did not appear), please go directly to the root directory of the DVD and double-click "Setup".

► Auto-run Menu

For Windows 10

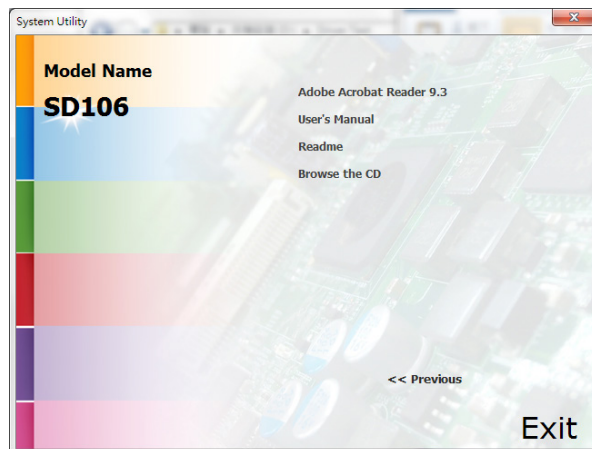
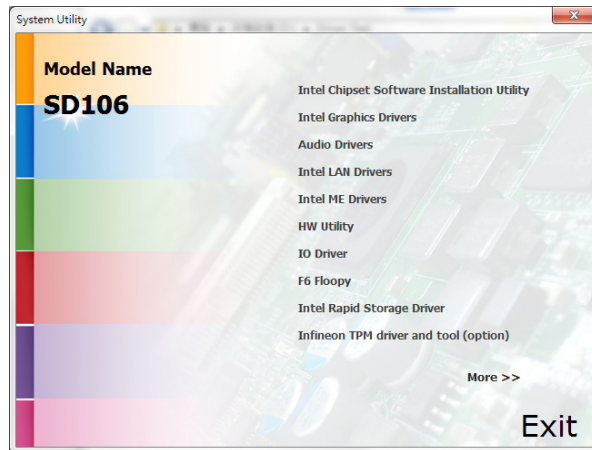

For Windows 8.1

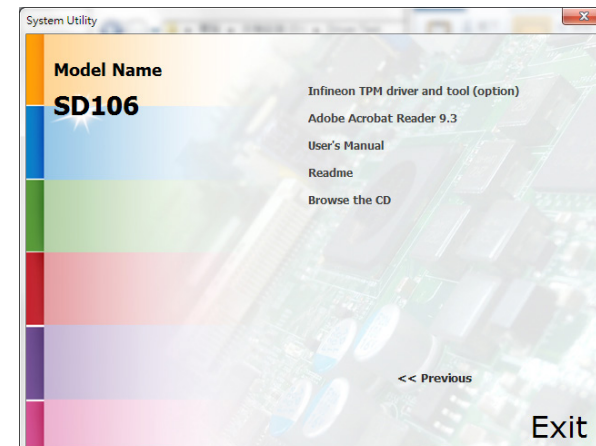
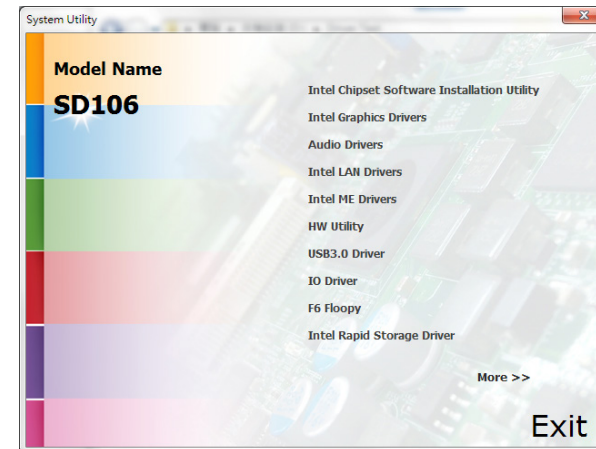

For Windows 7

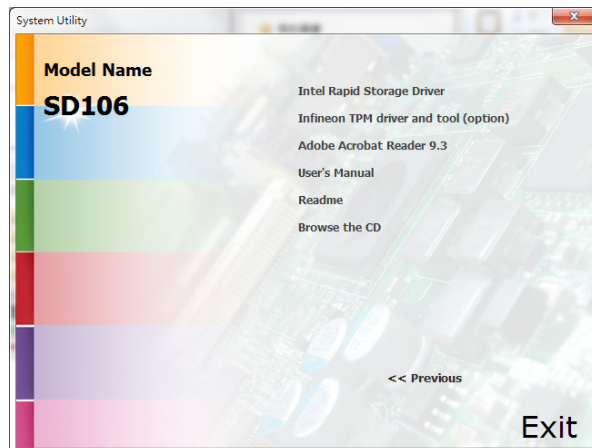
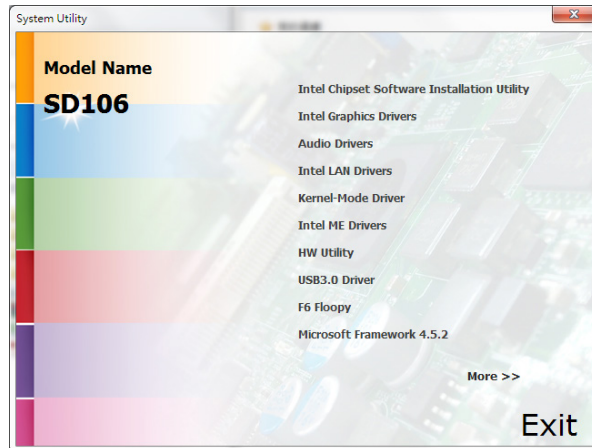

► Intel Chipset Software Installation Utility

The Intel Chipset Software Installation Utility is used for updating Windows® INF files so that the Intel chipset can be recognized and configured properly in the system.

To install the utility, click "Intel Chipset Software Installation Utility" on the main menu.

1. Setup is ready to install the utility. Click Next.



2. Read the license agreement then click Yes.



- Go through the readme document for more installation tips then click Next.



- Click Finish to exit setup.



► Intel Graphics Drivers

To install the driver, click "Intel Graphics Drivers" on the main menu.

- Setup is now ready to install the graphics driver. Click Next.



By default, the "Automatically run WinSAT and enable the Windows Aero desktop theme" is enabled. With this enabled, after installing the graphics driver and the system rebooted, the screen will turn blank for 1 to 2 minutes (while WinSAT is running) before the Windows 7/Windows 8.1/Windows 10 desktop appears. The "blank screen" period is the time Windows is testing the graphics performance.

- Read the license agreement then click Yes.

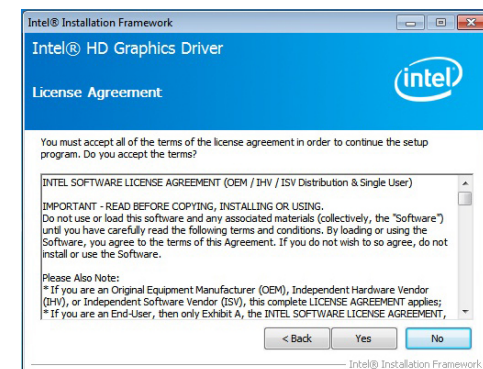

- Go through the readme document for system requirements and installation tips then click Next.

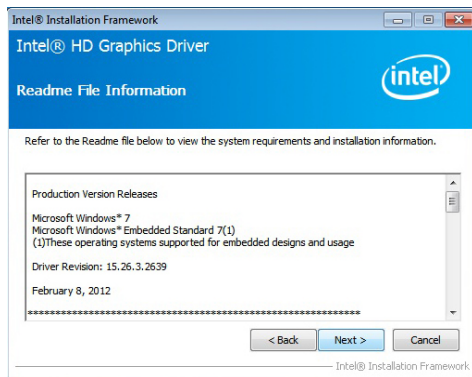

- Setup is now installing the driver. Click Next to continue.

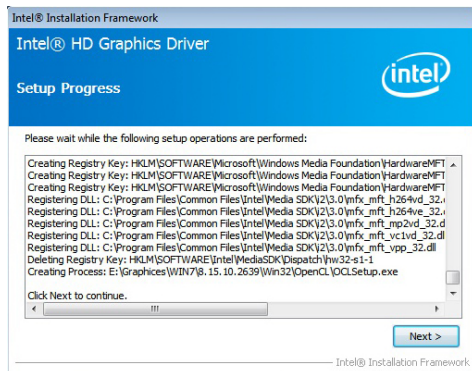

- Click "Yes, I want to restart this computer now" then click Finish.

Restarting the system will allow the new software installation to take effect.



► Audio Drivers

To install the driver, click "Audio Drivers" on the main menu.

- Setup is ready to install the driver. Click Next.

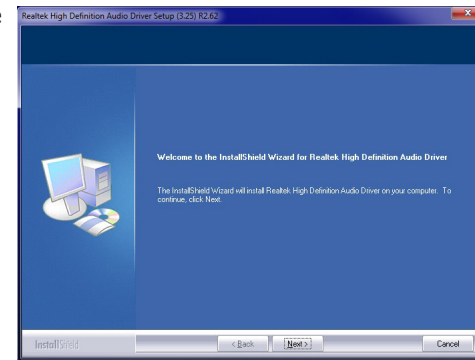

- Click "Yes, I want to restart my computer now" then click Finish.

Restarting the system will allow the new software installation to take effect.

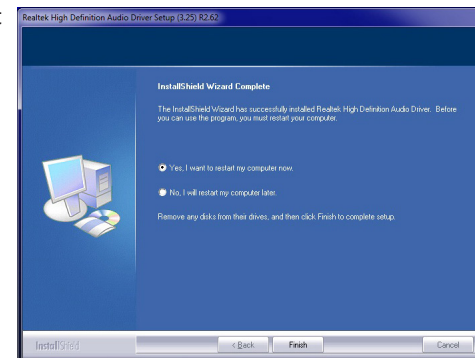

► Intel LAN Drivers

To install the driver, click "Intel LAN Drivers" on the main menu.

1. Setup is ready to install the driver. Click Next.



2. Click "I accept the terms in the license agreement" then click "Next".

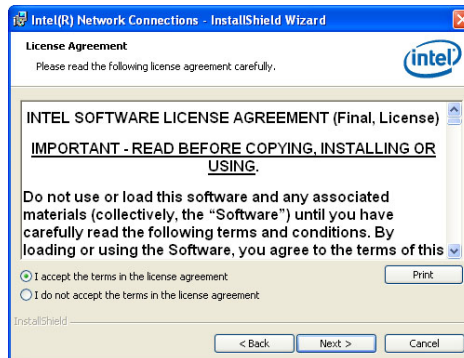

3. Select the program features you want installed then click Next.

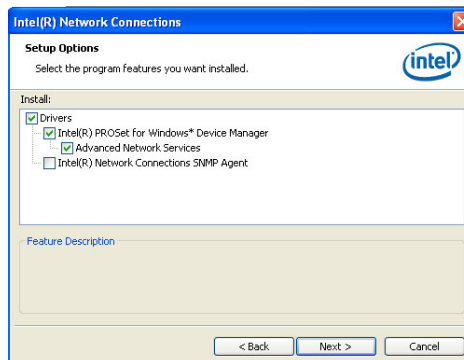

4. Click Install to begin the installation.

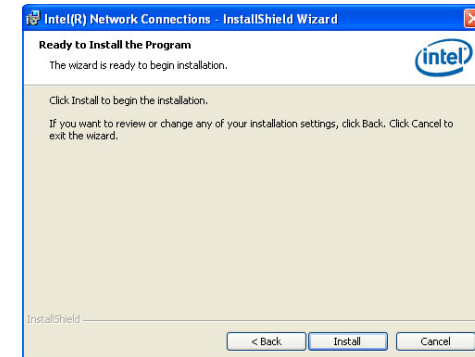

5. After completing installation, click Finish.

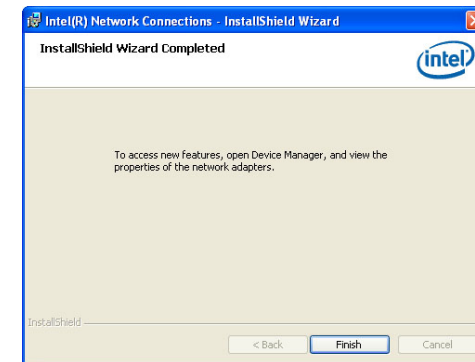

► Kernel Mode Driver Framework (For Windows 7 only)

To install the driver, click "Kernel Mode Driver Framework" on the main menu.

1. Click "Yes" to install the update.

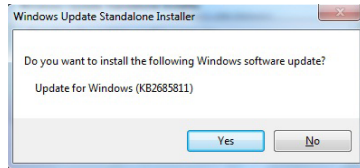

2. The update is installed now.

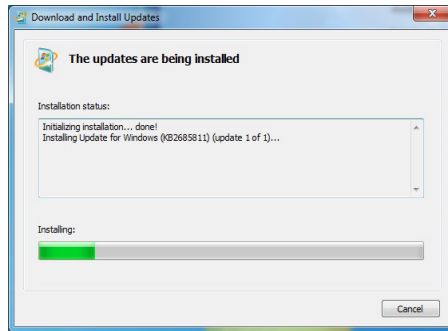

3. Click "Restart Now" to restart your computer when the installation is complete.

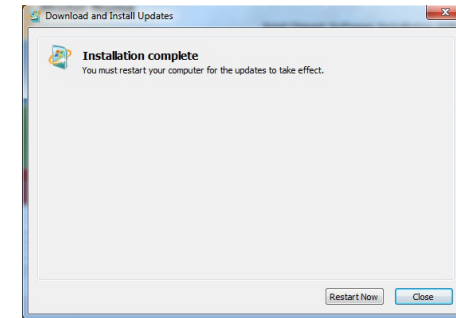

► Intel Management Engine Drivers

To install the driver, click "Intel Management Engine Drivers" on the main menu.

1. Setup is ready to install the driver. Click Next.

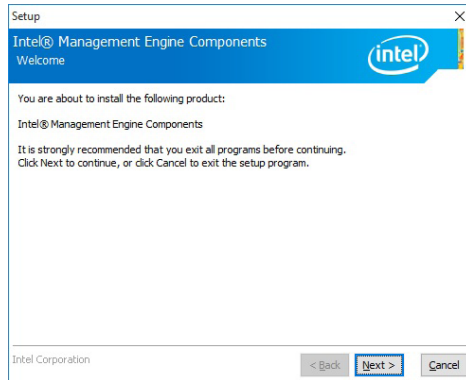

2. Read the license agreement then click Next.

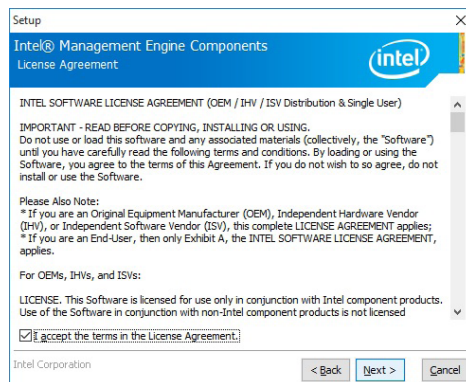

3. Setup is currently installing the driver. After installation has completed, click Next.

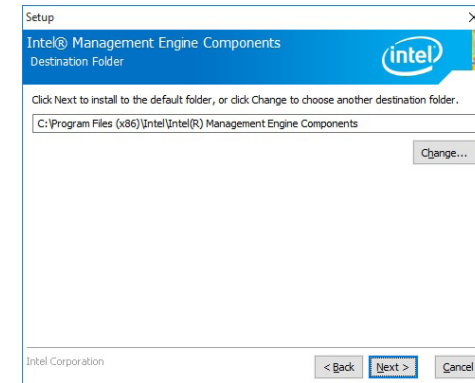

4. Please wait while the product is being installed.

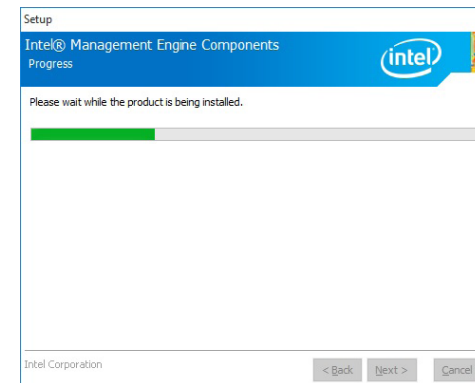

5. After completing installation, click Finish.

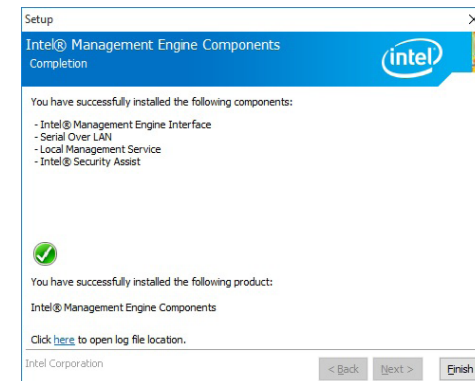

► **HW Utility**

HW Utility provides information about the board, Watchdog, and DIO. To access the utility, click "HW Utility" on the main menu.



Note:

If you are using Windows 7 or later versions, you need to access the operating system as an administrator to be able to install the utility.

1. Setup is ready to install the driver.

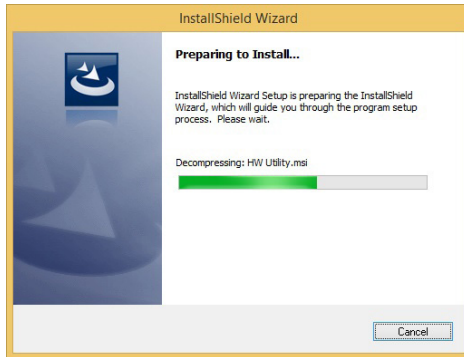

2. Click "Next" to continue.

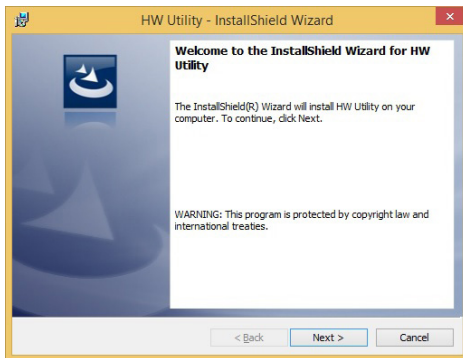

3. Read the license agreement then click "I accept the terms in the license agreement". Click "Next".

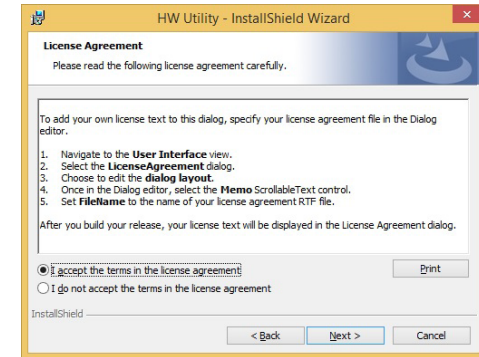

4. The wizard is ready to begin installation. Click "Install".

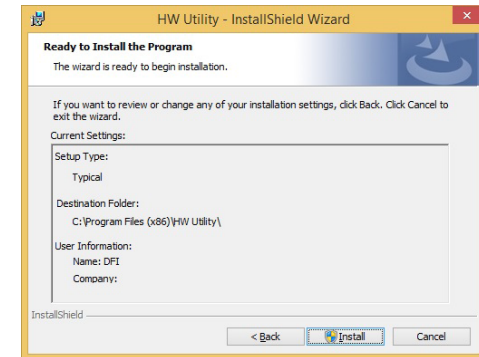

5. Please wait while the program features are being installed.

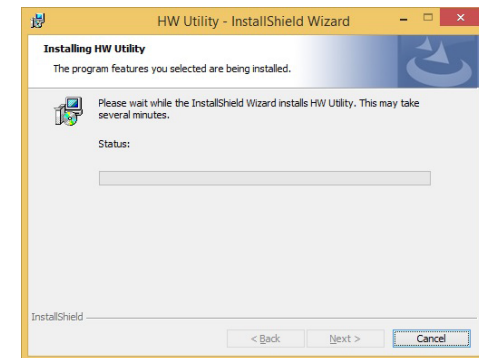

- After completing installation, click "Finish".



The HW Utility icon will appear on the desktop. Double-click the icon to open the utility.



Information



HW Health

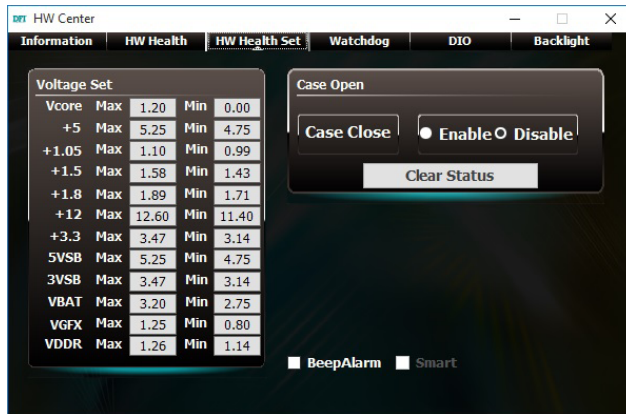

HW Health Set

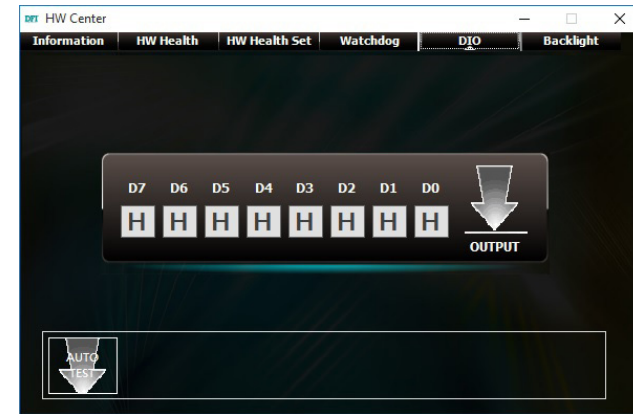

DIO

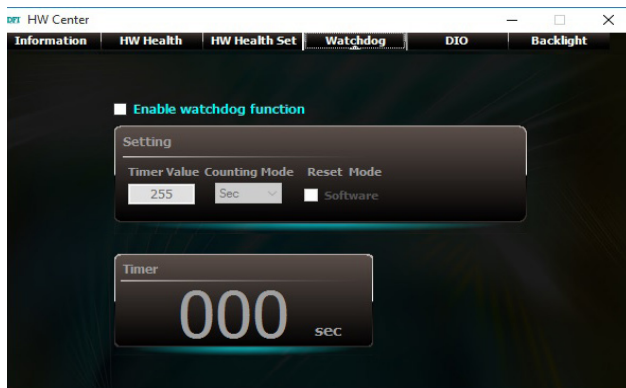

WatchDog

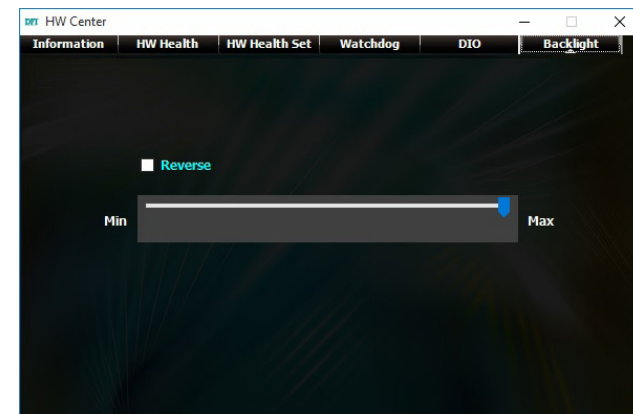

Backlight

► Intel USB 3.0 Drivers (For Windows 7 and Windows 8.1)

To install the driver, click "Intel USB 3.0 Driver" on the main menu.

1. Setup is ready to install the driver. Click Next.

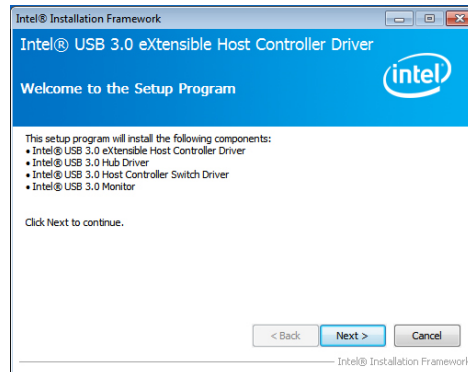

2. Read the license agreement then click Yes.

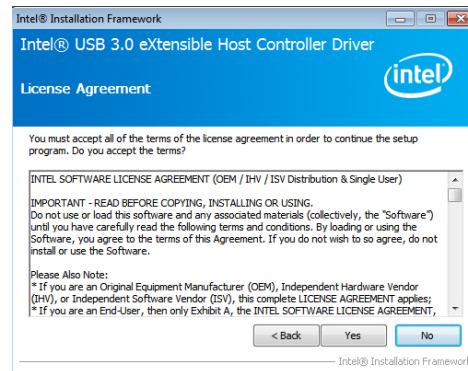

3. Go through the readme document for more installation tips then click Next.

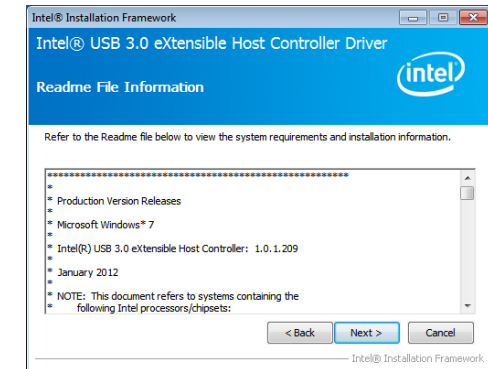

4. Setup is currently installing the driver. After installation has completed, click Next.

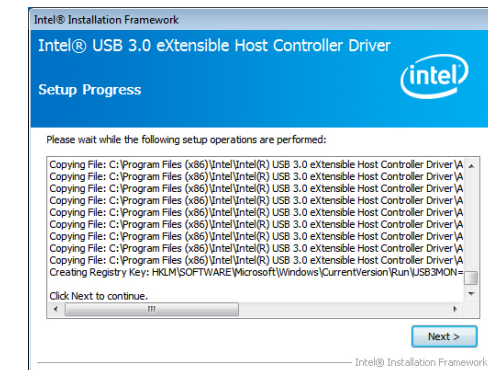

5. After completing installation, click Finish.

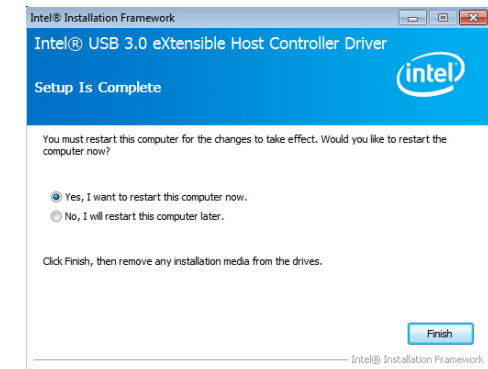

► IO Driver (For Windows 8.1 and Windows 10)

To install the driver, click "Intel Serial IO Driver" on the main menu

1. Setup is ready to install the driver.
Click Next.

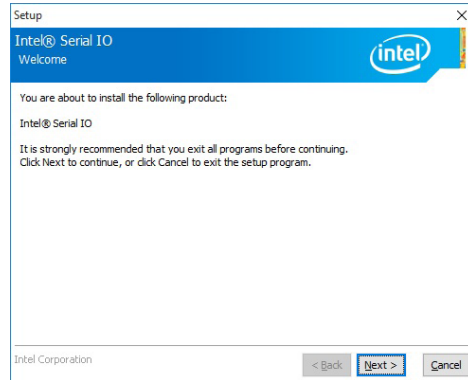

2. Read the license agreement carefully.

Click "I accept the terms in the License Agreement" then click Next.

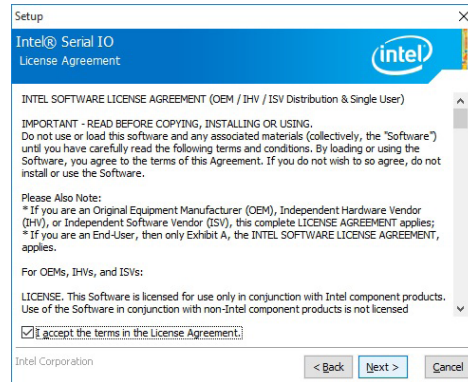

3. Read the file information then click Next.

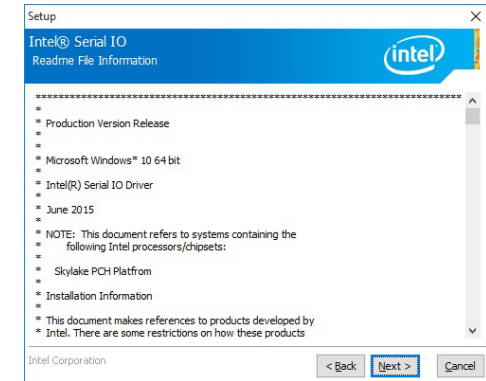

4. Setup is ready to install the driver.
Click Next.

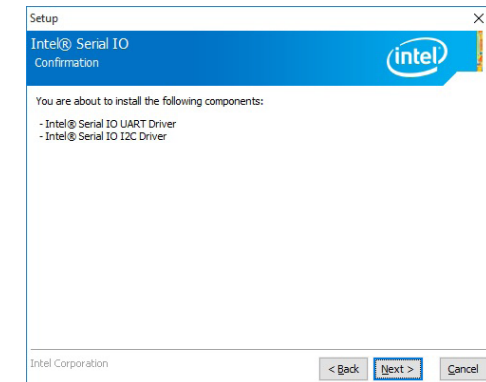

5. Setup is now installing the driver.

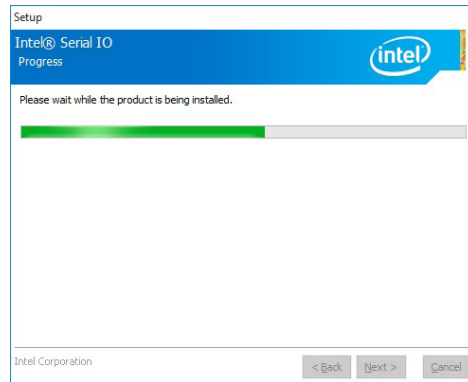

6. Click Finish.

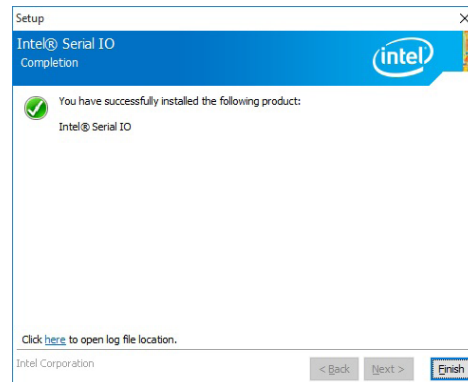

► Microsoft Framework 4.5.2 (For Windows 7)



Note:

Before installing Microsoft Framework 4.5.2, make sure you have updated your Windows 7 operating system to Service Pack 3.

To install the driver, click "Microsoft Framework 4.5.2" on the main menu.

1. Setup is now extracting files.

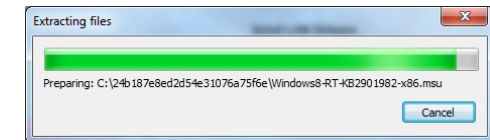

2. Read the license agreement carefully.

Click "I have read and accept the terms of the License Agreement" then click Install.

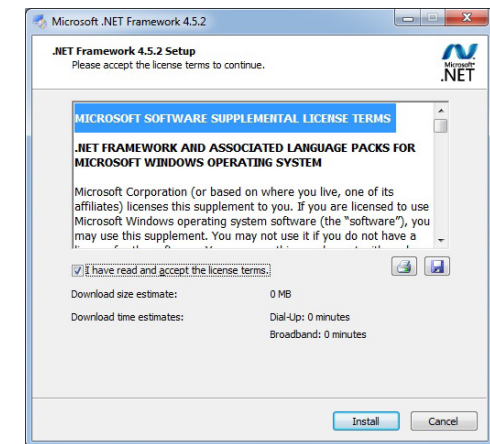

3. Setup is now installing the driver.

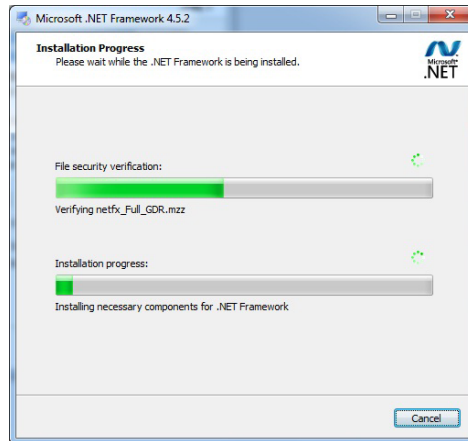

4. Click Finish.

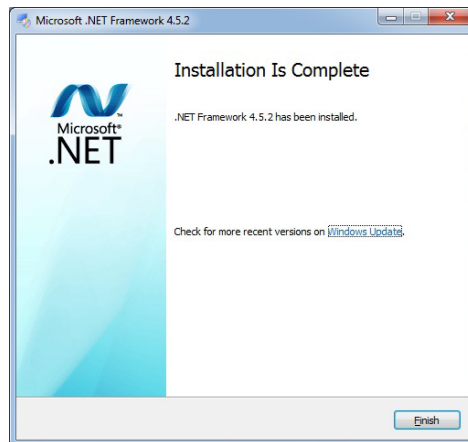

► Intel Rapid Storage Technology

The Intel Rapid Storage Technology is a utility that allows you to monitor the current status of the SATA drives. It enables enhanced performance and power management for the storage subsystem.

To install the driver, click "Intel Rapid Storage Technology" on the main menu. Please refer to **Chapter 5** for more information.

► Infineon TPM 1.2 Driver and Tool (optional)

To install the driver, click "Infineon TPM driver and tool (option)" on the main menu.

Note:

1. This driver only supports TPM 1.2.
2. TPM 2.0 is only supported on Windows 8.1 / Windows 10; for Windows 7, please turn off TPM 2.0 in the BIOS if the TPM configuration exists.

1. The setup program is preparing to install the driver.

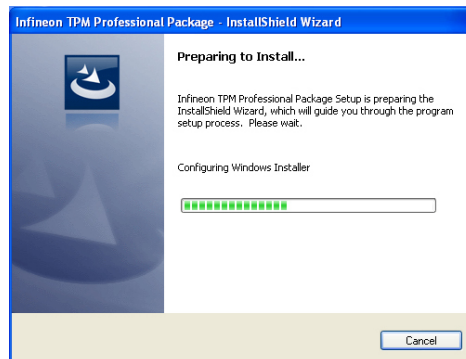

2. The setup program is now ready to install the utility. Click Next.

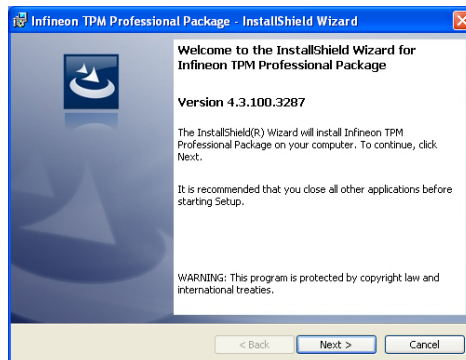

3. Click "I accept the terms in the license agreement" and then click "Next".

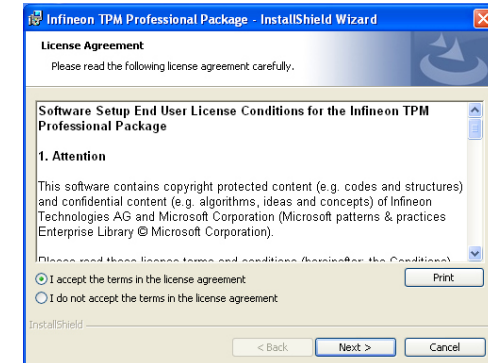

4. Enter the necessary information and then click Next.

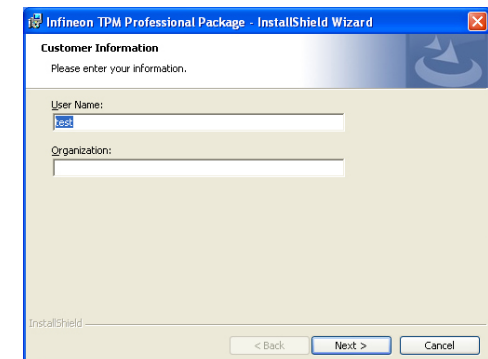

5. Select a setup type and then click Next.

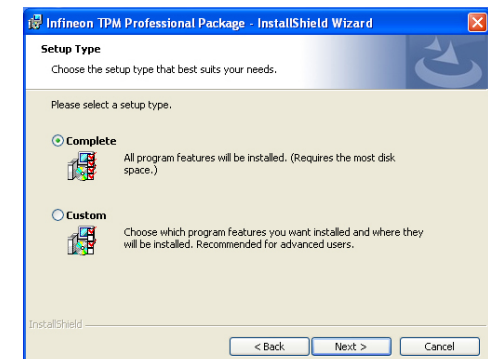

6. Click Install.

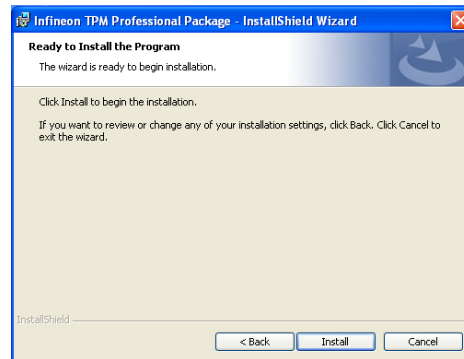

7. TPM requires installing the Microsoft Visual C++ package prior to installing the utility. Click Install.

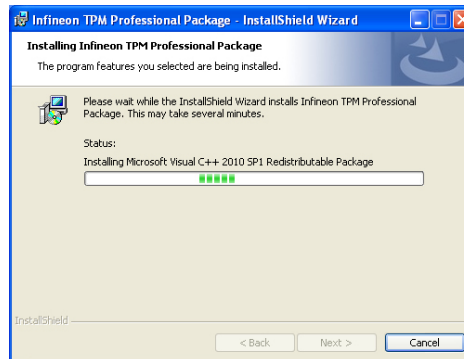

8. The setup program is currently installing the Microsoft Visual C++ package.

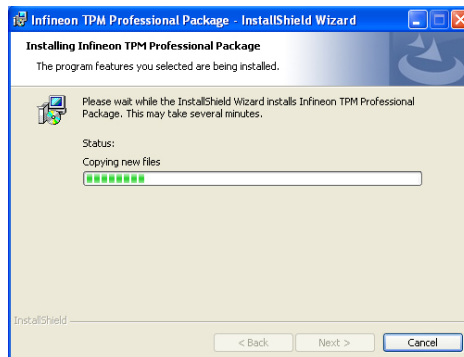

9. Click Finish.

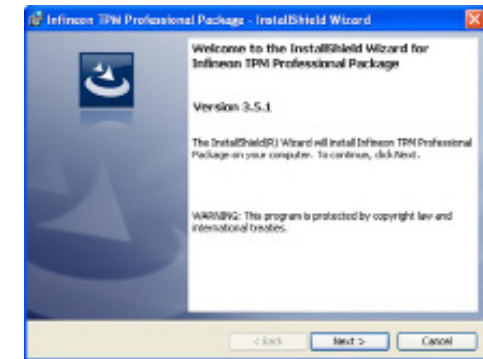

10. Click "Yes" to restart your system.

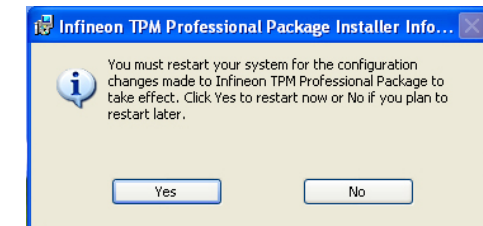

► Adobe Acrobat Reader 9.3

To install the reader, click "Adobe Acrobat Reader 9.3" on the main menu.

1. Click Next to install or click Change Destination Folder to select another folder.

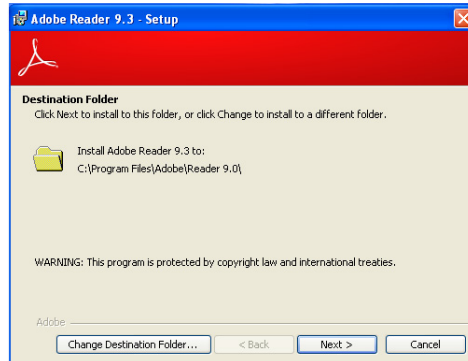

2. Click Install to begin installation.

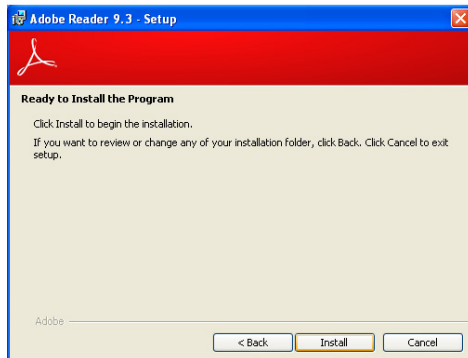

3. Click Finish to exit installation.

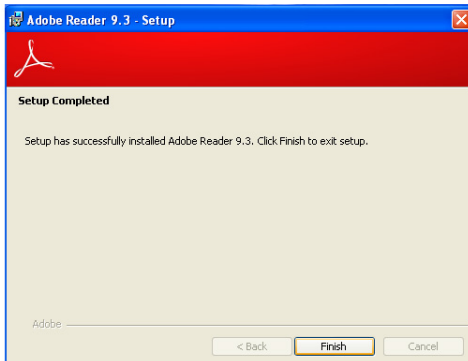

Chapter 5 - RAID

The system board allows configuring RAID on Serial ATA drives. It supports RAID 0, RAID 1, RAID 5 and RAID 10.

RAID Levels

RAID 0 (Striped Disk Array without Fault Tolerance)

RAID 0 uses two new identical hard disk drives to read and write data in parallel, interleaved stacks. Data is divided into stripes and each stripe is written alternately between two disk drives. This improves the I/O performance of the drives at different channel; however it is not fault tolerant. A failed disk will result in data loss in the disk array.

RAID 1 (Mirroring Disk Array with Fault Tolerance)

RAID 1 copies and maintains an identical image of the data from one drive to the other drive. If a drive fails to function, the disk array management software directs all applications to the other drive since it contains a complete copy of the drive's data. This enhances data protection and increases fault tolerance to the entire system. Use two new drives or an existing drive and a new drive but the size of the new drive must be the same or larger than the existing drive.

RAID 5

RAID 5 stripes data and parity information across hard drives. It is fault tolerant and provides better hard drive performance and more storage capacity.

RAID 10 (Mirroring and Striping)

RAID 10 is a combination of data striping and data mirroring providing the benefits of both RAID 0 and RAID 1. Use four new drives or an existing drive and three new drives for this configuration.

RAID Level	Min. Drives	Protection	Description
RAID 0	2	None	Data striping without redundancy
RAID 1	2	Single Drive Failure	Disk mirroring
RAID 5	3	Single Drive Failure	Block-level data striping with distributed parity
RAID 10	4	1 Disk Per Mirrored Stripe (not same mirror)	Combination of RAID 0 (data striping) and RAID 1 (mirroring)

Settings

To enable the RAID function, the following settings are required.

1. Connect the Serial ATA drives.
2. Enable RAID in the Insyde BIOS.
3. Create a RAID volume.
- 3-1. Create a RAID volume if the boot type is UEFI.
4. Install the Intel Rapid Storage Technology Utility.

Step 1: Connect the Serial ATA Drives

Refer to chapter 2 for details on connecting the Serial ATA drives.



Important:

1. Make sure you have installed the Serial ATA drives and connected the data cables otherwise you won't be able to enter the RAID BIOS utility.
2. Treat the cables with extreme caution especially while creating RAID. A damaged cable will ruin the entire installation process and operating system. The system will not boot and you will lost all data in the hard drives. Please give special attention to this warning because there is no way of recovering back the data.

Step 2: Enable RAID in the Insyde BIOS

1. Power-on the system then press to enter the main menu of the Insyde BIOS.
2. Go to "Advanced" menu and select the "SATA Configuration" menu.
3. Change the "SATA Mode Selection" to "RAID" mode.
4. Save the changes in the "Exit" menu.
5. Reboot the system.

Step 3: Create a RAID Volume

1. When the Intel® RST option ROM status screen displays during POST, press <Ctrl> and <I> simultaneously to enter the option ROM user interface.
2. Select 1: Create RAID Volume and press <Enter>.
3. Create a volume name and press <Enter>.
4. Use the up or down arrow keys to select the RAID level and press <Enter>.
5. Use the up or down arrow keys to select the strip size and press <Enter>.
6. Select the capacity and press <Enter>. You must select less than one hundred percent of the available volume space to leave space for the second volume.
7. Press <Enter> to create the volume.
8. At the prompt, press <Y> to confirm volume creation.
9. Select 4: Exit and press <Enter>.
10. Press <Y> to confirm exit.

Step 3-1: Create a RAID Volume if the boot type is UEFI

If the boot type is set to UEFI, RAID volume creation will be different. Please use the following steps to create RAID volumes. To set the boot type, enter the Insyde BIOS and go to "Boot" > "Boot Type".

1. Go to the "Advanced" menu of the Insyde BIOS and select "Device Manager".

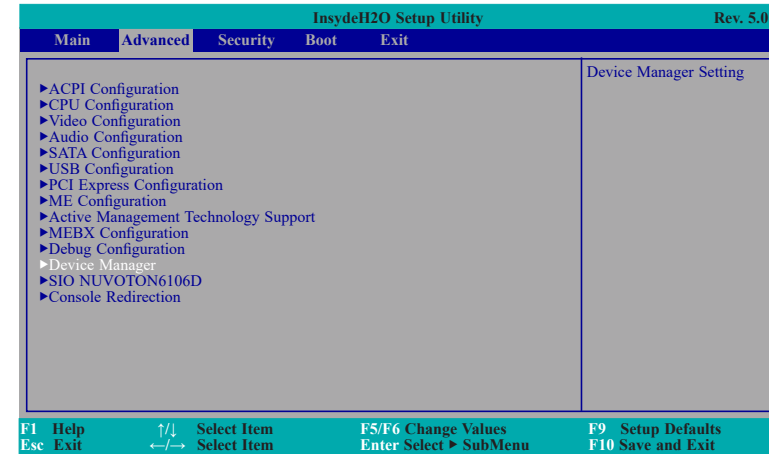

2. The screen displays all available drives. Select "Create RAID volume" to create a RAID volume.
3. Use the up or down arrow keys to select the RAID level and press <Enter>.
4. Use the up or down arrow keys to scroll through the list of hard drives and press <Enter> to select the drive.
5. Press <Enter>.
6. Use the up or down arrow keys to select the strip size and press <Enter>.
7. Enter the volume size and press <Enter>.
8. At the prompt, press <Y> to confirm volume creation.

Step 4: Install the Intel Rapid Storage Technology Utility

The Intel Rapid Storage Technology Utility can be installed from within Windows. It allows RAID volume management (create, delete, migrate) from within the operating system. It will also display useful SATA device and RAID volume information. The user interface, tray icon service and monitor service allow you to monitor the current status of the RAID volume and/or SATA drives. It enables enhanced performance and power management for the storage subsystem.

1. Download "SD106 IRST Driver" zip file at our website.
2. Setup is ready to install the utility. Click "Next".

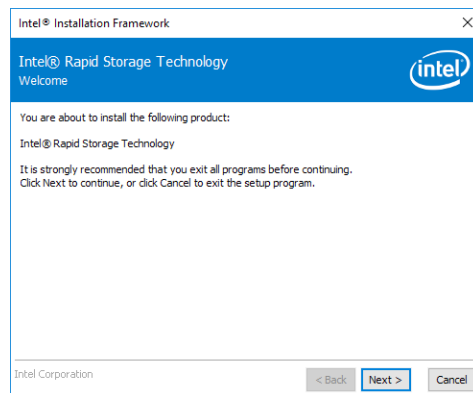

3. Read the license agreement and click "I accept the terms in the License Agreement". Then, click "Next".

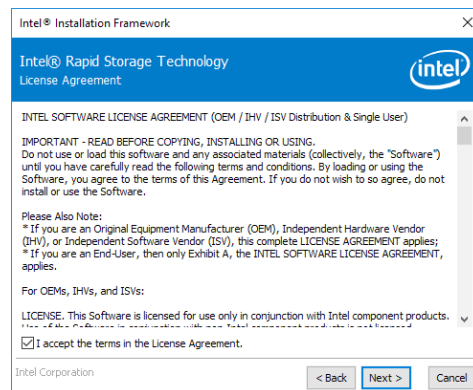

4. Go through the readme document to view system requirements and installation information then click "Next".

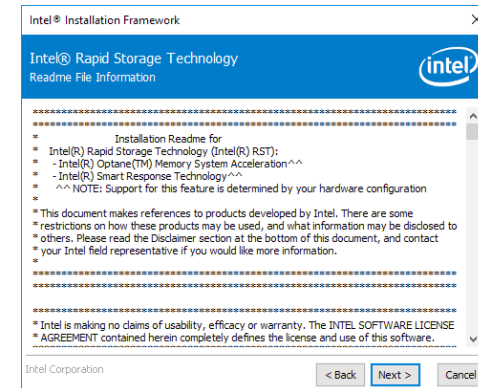

5. Click "Next" to install to the default folder or click "Change" to choose another destination folder".

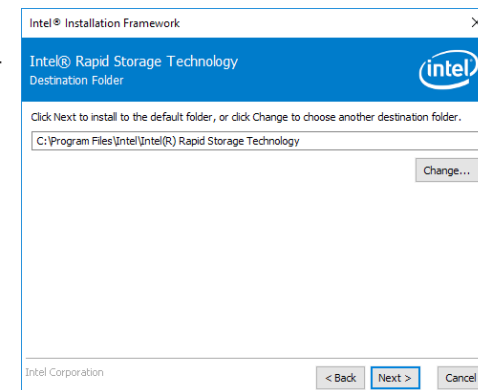

6. Confirm the installation and click "Next".

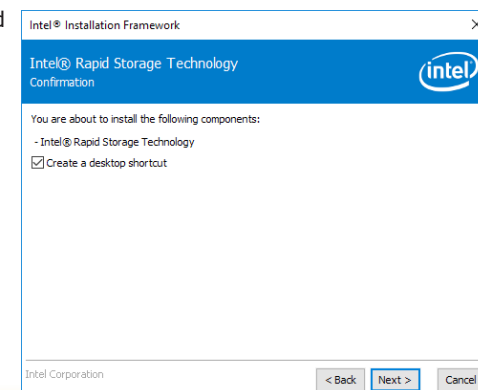

7. Click "Yes, I want to restart this computer now" to complete the installation and then click "Finish".

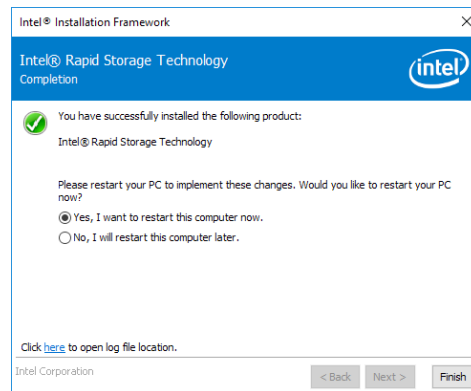

Chapter 6 - Intel AMT Settings

► Overview

Intel Active Management Technology (Intel® AMT) combines hardware and software solution to provide maximum system defense and protection to networked systems. The hardware and software information are stored in non-volatile memory. With its built-in manageability and latest security applications, Intel® AMT provides the following functions.

Discover

Allows remote access and management of networked systems even while PCs are powered off; significantly reducing desk-side visits.

Repair

Remotely repair systems after OS failures. Alerting and event logging help detect problems quickly to reduce downtime.

Protect

Intel AMT's System Defense capability remotely updates all systems with the latest security software. It protects the network from threats at the source by proactively blocking incoming threats, reactively containing infected clients before they impact the network, and proactively alerting when critical software agents are removed.

► Enabling Intel® AMT in the Insyde BIOS

1. Power-on the system then press to enter the main menu of the Insyde BIOS.
2. In the **Advanced** menu, select **Active Management Technology Support**.

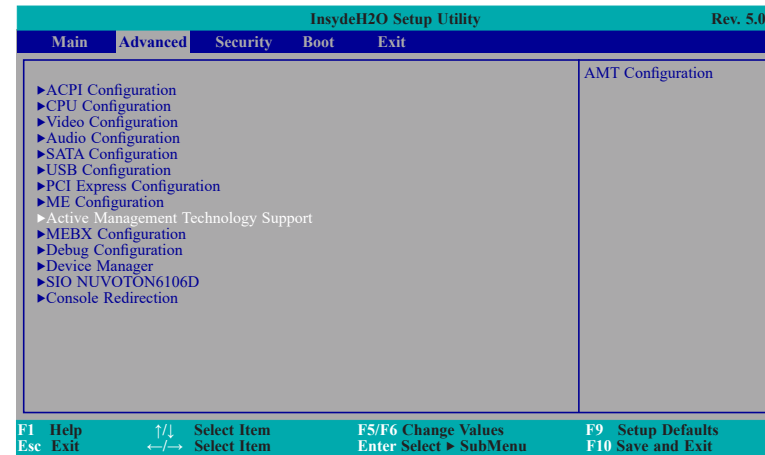

3. Select **Enabled** in the **Intel AMT Support** field.

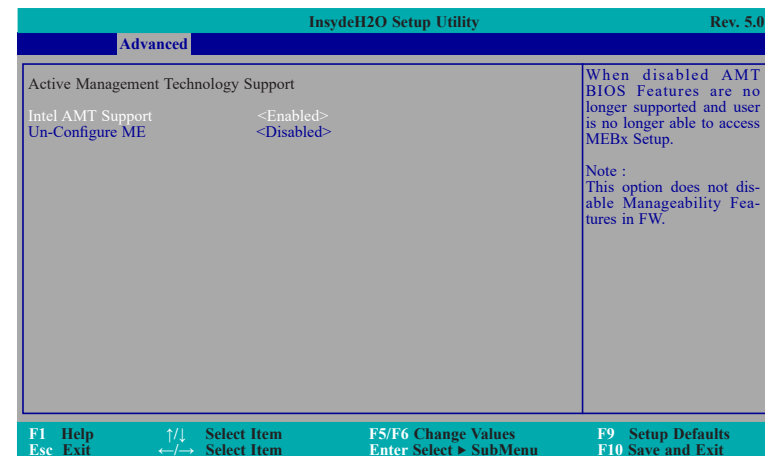

► Enabling Intel® AMT in the Insyde BIOS

4. In the **Exit** menu, select **Exit Saving Changes** then select **Yes** and press Enter.

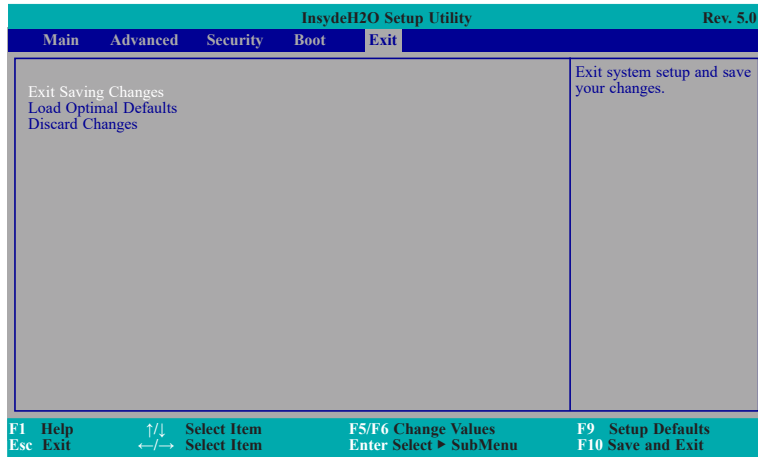

► Entering Management Engine BIOS Extension (MEBx)

1. After the system reboots, press to enter the main menu of the Insyde BIOS.
2. In the **Advanced** menu, select **MEBx Configuration**.

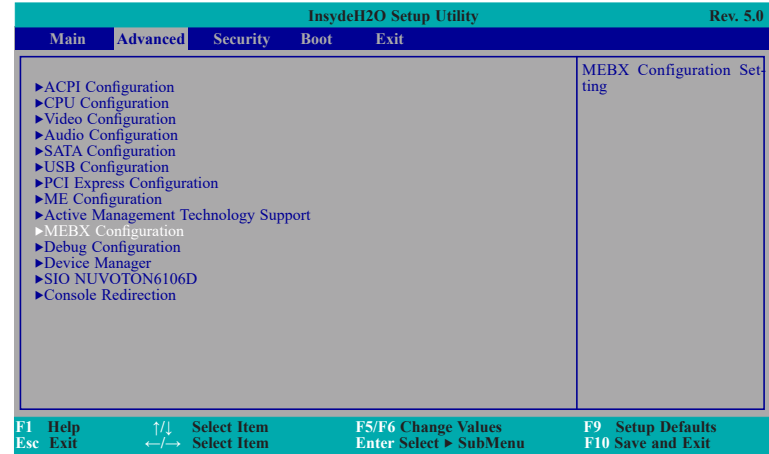

3. Select **MEBx Configuration** and press Enter.

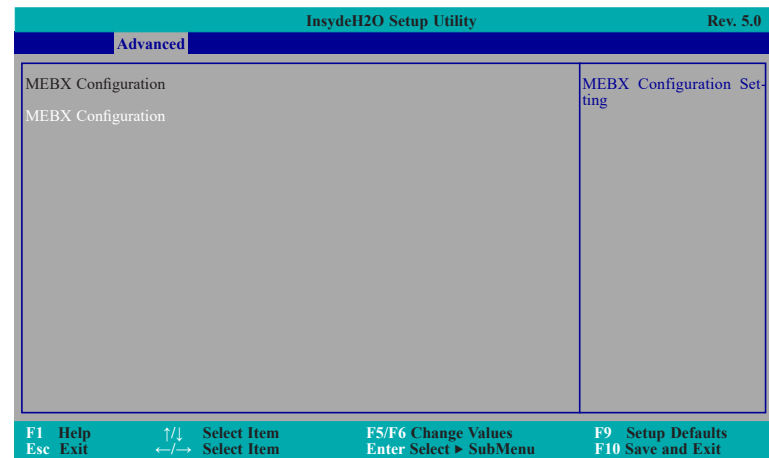

► MEBX

Main Menu

Select **MEBx Login** under Main Menu and press Enter. You will be prompted for a password. The default password is **“admin”**. Enter the default password in the prompt and then press Enter.

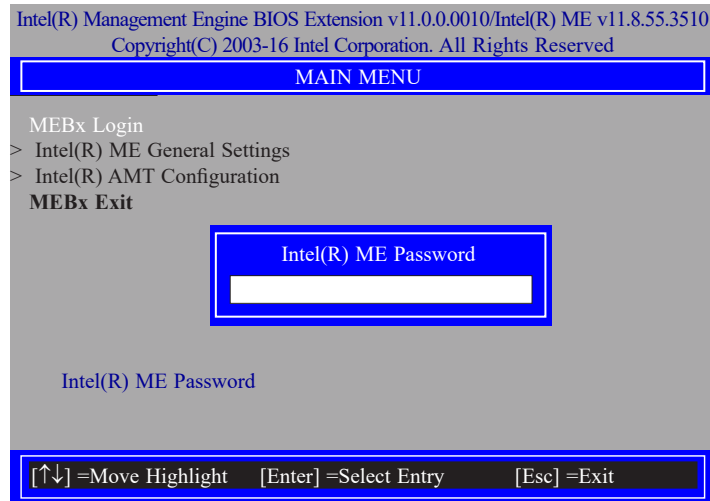

Enter a new password in the prompt and then press Enter. The password must include:

- 8-32 characters
- Strong 7-bit ASCII characters excluding : , and " characters
- At least one digit character (0, 1, ...9)
- At least one 7-bit ASCII non alpha-numeric character, above 0x20, (e.g. !, \$, ;)
- Both lower case and upper case characters



You will be asked to verify the new password. Enter the same new password in the prompt and then press Enter.



► MEBX

Intel(R) ME General Settings

Select **Intel(R) ME General Settings** under Main Menu and then press Enter.

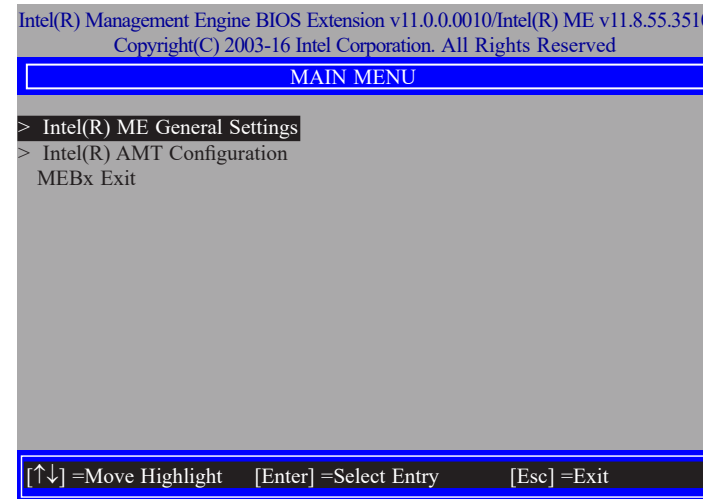

► MEBX ► Intel(R) ME General Settings

Change ME Password

If you want to change ME password, select **Change ME Password** then press Enter. Enter the current password in the space provided under Intel(R) ME Password then press Enter.

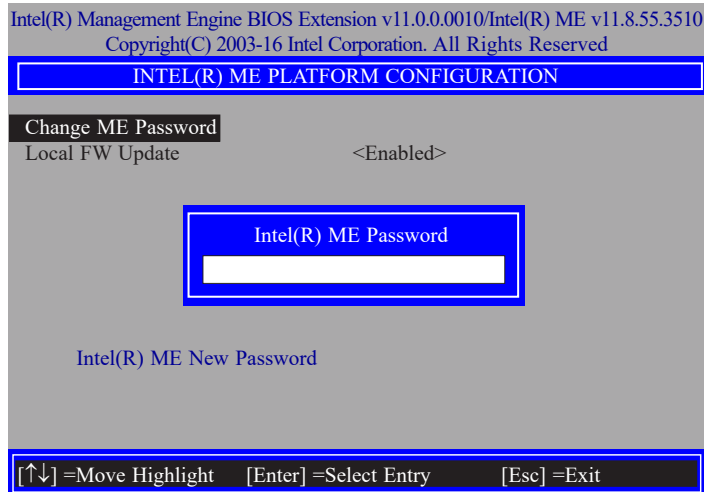

Enter a new password in the space provided under Intel(R) ME New Password then press Enter. The password must include:

- 8-32 characters
- Strong 7-bit ASCII characters excluding : , and " characters
- At least one digit character (0, 1, ...9)
- At least one 7-bit ASCII non alpha-numeric character, above 0x20, (e.g. !, \$, ;)
- Both lower case and upper case characters



You will be asked to verify the new password. Enter the same new password in the space provided under Verify Password then press Enter.



► MEBX ► Intel(R) ME General Settings

Local FW Update

Select **Local FW Update** then press Enter. Select **Enabled** or **Disabled** or **Password Protected** then press Enter.

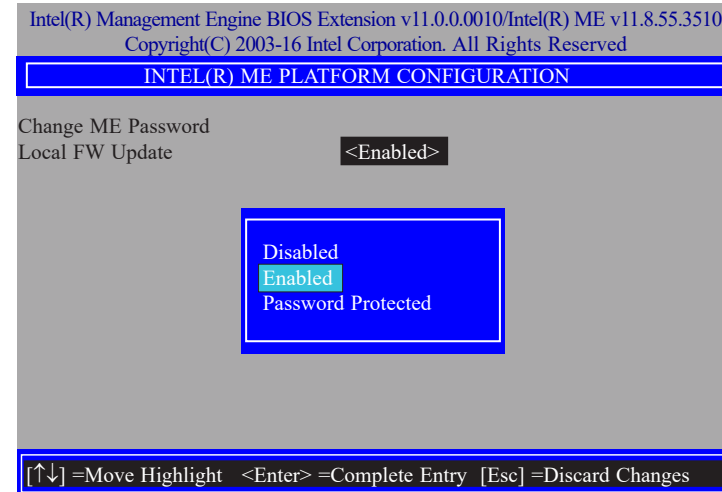

► MEBX

Intel(R) AMT Configuration

Select **Intel(R) AMT Configuration** under Main Menu and then press Enter.

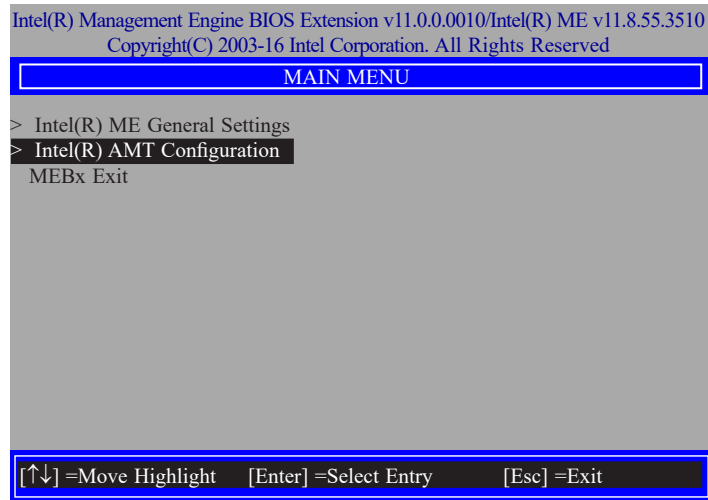
**Manageability Feature Selection**

Select **Enabled** or **Disabled** then press Enter. When disabled, all the following fields will be hidden. After disabling the field, system restart is required.

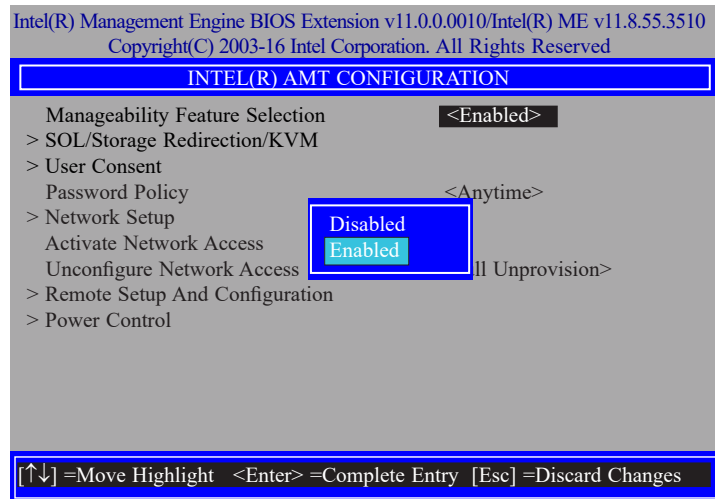

► MEBX ► Intel(R) AMT Configuration

> SOL/Storage Redirection/KVM

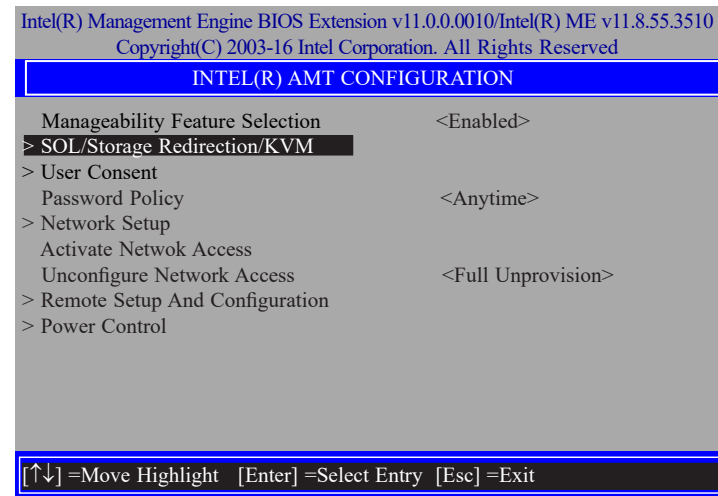

Press Enter to enter the submenu.

► MEBX ► Intel(R) AMT Configuration

> SOL/Storage Redirection/KVM

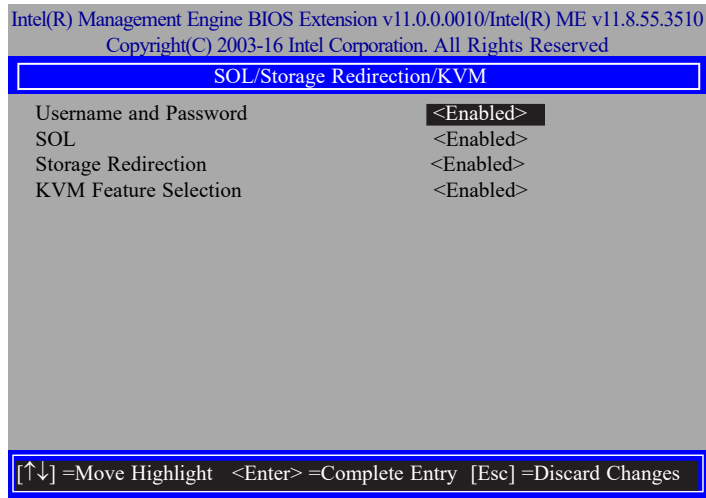

Move the cursor to select a field and press Enter to display options.

Username and Password

Select Enabled or Disabled then press Enter.

SOL

Select Enabled or Disabled then press Enter.

Storage Redirection

Select Enabled or Disabled then press Enter.

KVM Feature Selection

Select Enabled or Disabled then press Enter.



► MEBX ► Intel(R) AMT Configuration

> User Consent

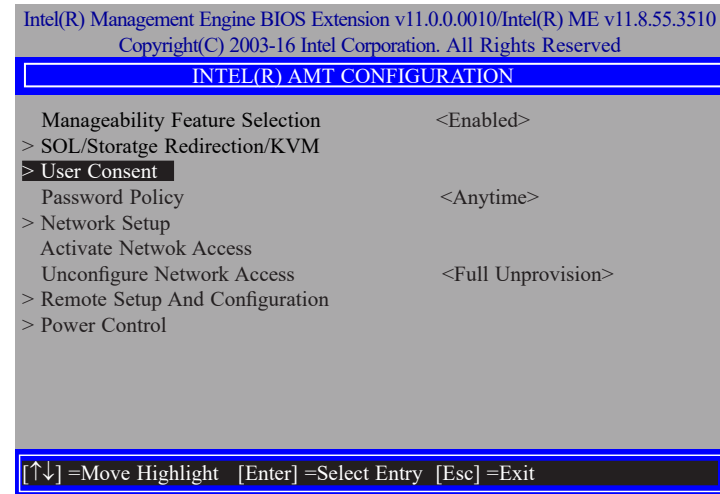

Press Enter to enter the submenu.

► MEBX ► Intel(R) AMT Configuration

> User Consent

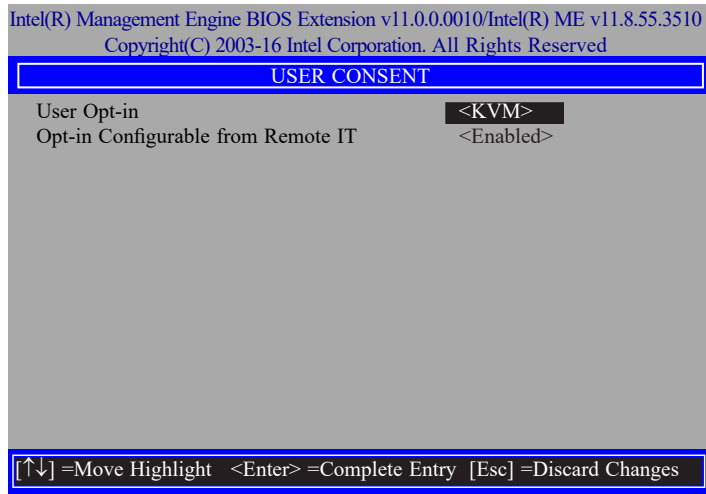

Move the cursor to select a field and press Enter to display options.

User Opt-in

Select **NONE** or **KVM** or **ALL** then press Enter.



Opt-in Configurable from Remote IT

Select **Enabled** or **Disabled** then press Enter.



► MEBX ► Intel(R) AMT Configuration

Password Policy

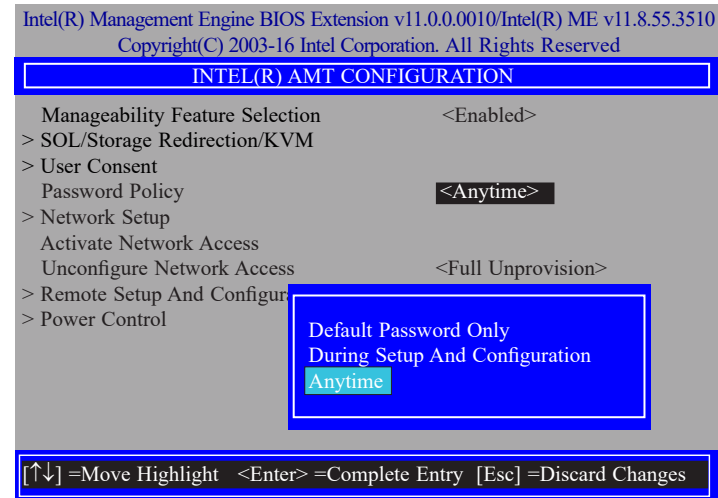

Under the **Intel(R) AMT Configuration** menu, select **Password Policy** then press Enter. You may choose to use a password only during setup and configuration or to use a password anytime the system is being accessed.

► MEBX ► Intel(R) AMT Configuration

> Network Setup

Under the **Intel(R) AMT Configuration** menu, select **Network Setup** and then press Enter.

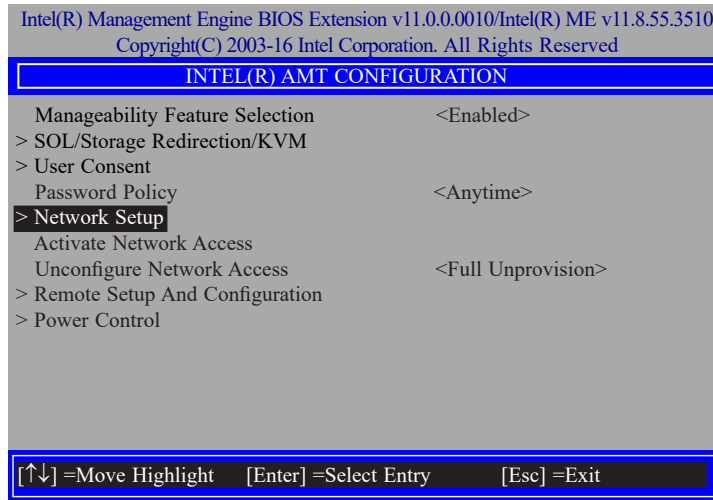

> Intel(R) ME Network Name Settings

Under the **Intel(R) ME Network Setup** menu, select **Intel(R) ME Network Name Settings** and then press Enter.

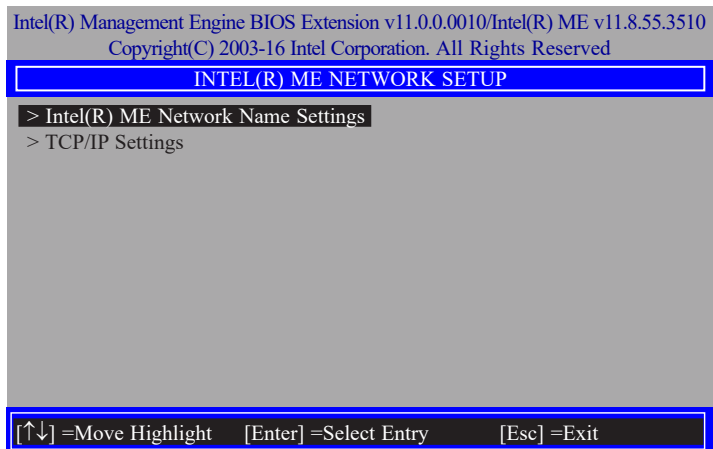

Move the cursor to select a field and press Enter to display options.

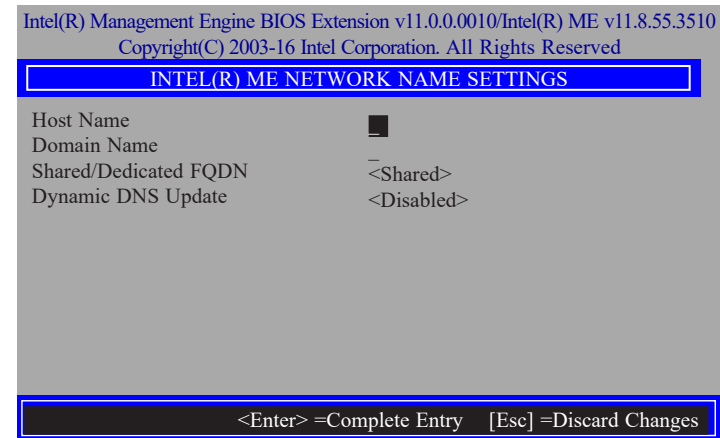

Host Name

Enter the computer's host name and then press Enter.

Computer Host Name

Domain Name

Enter the computer's domain name and then press Enter.

Computer Domain Name

Shared/Dedicated FQDN

Select **Shared** or **Dedicated** and then press Enter.

Dedicated
Shared

► MEBX ► Intel(R) AMT Configuration
 > Network Setup > Intel(R) ME Network Name Settings

Dynamic DNS Update

Select Enabled or Disabled then press Enter. When Dynamic DNS Update is Enabled, the following fields will show up.



Periodic Update Interval

Enter a value and then press Enter.

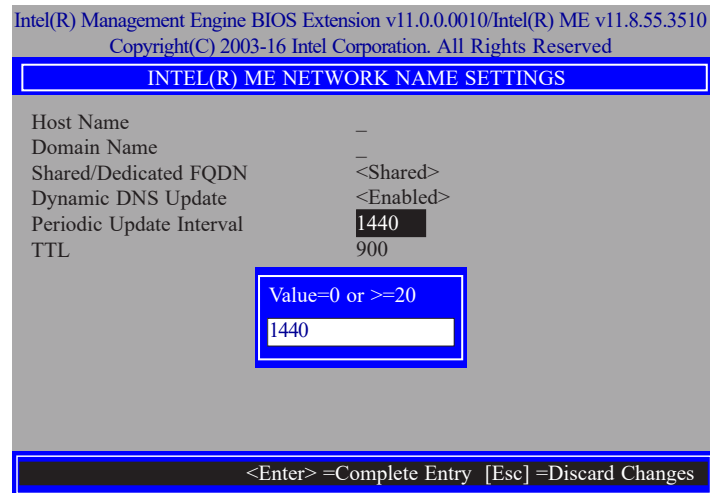

TTL

Enter a value for the Time-to-live (TTL) field and then press Enter.

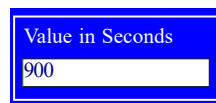

► MEBX ► Intel(R) AMT Configuration
 > Network Setup

> TCP/IP Settings

Under the **Intel(R) ME Network Setup** menu, select **TCP/IP Settings** and then press Enter.

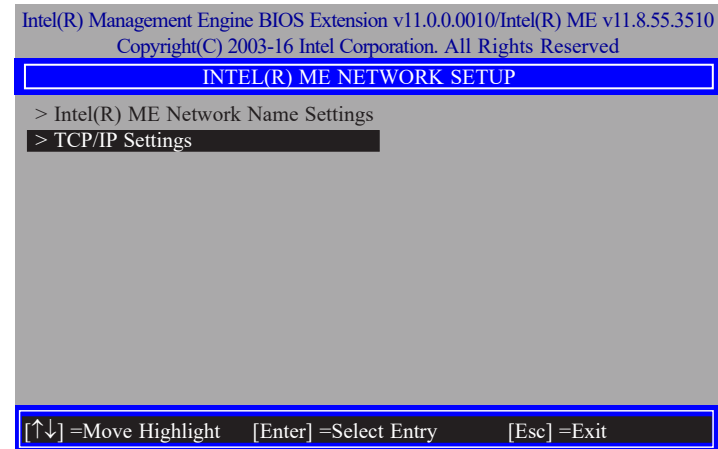

> Wired LAN IPV4 Configuration

Under **TCP/IP Settings**, select **Wired LAN IPV4 Configuration** and then press Enter.

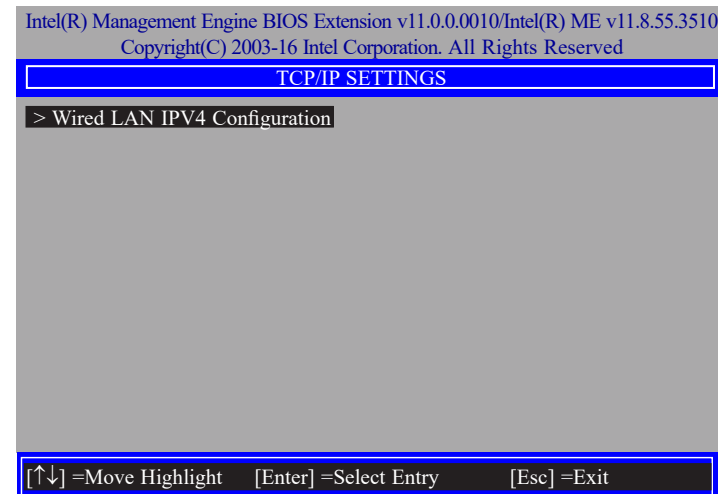

► **MEBX** ► **Intel(R) AMT Configuration**
 > **Network Setup** > **TCP/IP Settings**

DHCP Mode

Select **Enabled** or **Disabled** then press Enter. Please make sure there is a DHCP server in the network when this field is enabled.

Intel(R) Management Engine BIOS Extension v11.0.0.0010/Intel(R) ME v11.8.55.3510
 Copyright(C) 2003-16 Intel Corporation. All Rights Reserved

WIRED LAN IPV4 CONFIGURATION

DHCP Mode <Enabled>

Disabled
 Enabled

[↑↓] =Move Highlight <Enter> =Complete Entry [Esc] =Discard Changes

When DHCP is **Disabled**, please manually input a static route by configuring the fields as shown below.

Intel(R) Management Engine BIOS Extension v11.0.0.0010/Intel(R) ME v11.8.55.3510
 Copyright(C) 2003-16 Intel Corporation. All Rights Reserved

WIRED LAN IPV4 CONFIGURATION

DHCP Mode	<Disabled>
IPV4 Address	0.0.0.0
Subnet Mask Address	0.0.0.0
Default Gateway Address	0.0.0.0
Preferred DNS Address	0.0.0.0
Alternate DNS Address	0.0.0.0

<Enter> =Complete Entry [Esc] =Discard Changes

IPv4 Address

Assign a valid and available IP address to the system. Insert a value from 0.0.0.0 to 255.255.255.255 in IPv4 format.

IP address (e.g. 123.123.123.100)

Subnet Mask Address

Insert a value from 0.0.0.0 to 255.255.255.255 in IPv4 format.

Subnet mask (e.g. 255.255.255.0)

Default Gateway Address

Insert a value from 0.0.0.0 to 255.255.255.255 in IPv4 format.

Default Gateway address

Preferred DNS Address

Insert a value from 0.0.0.0 to 255.255.255.255 in IPv4 format.

Preferred DNS address

Alternate DNS Address

Insert a value from 0.0.0.0 to 255.255.255.255 in IPv4 format.

Alternate DNS address

► MEBX ► Intel(R) AMT Configuration

Activate Network Access

Under the **Intel(R) AMT Configuration** menu, select **Activate Network Access** and press Enter, and then press Y to activate the ME network connection with the settings configured previously, or press N to abort.

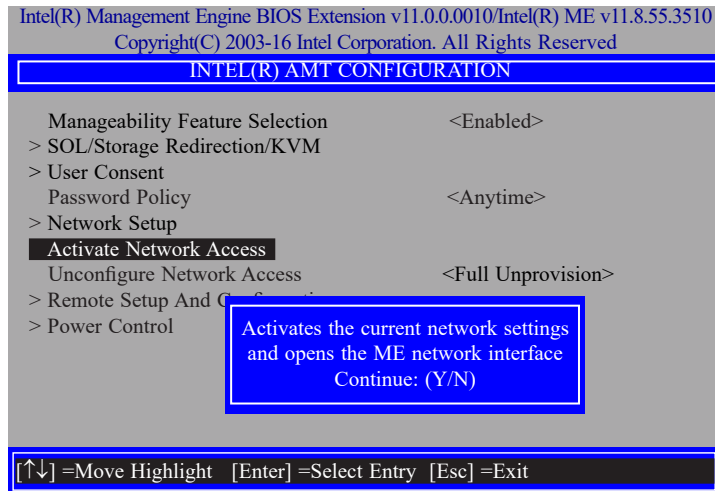

► MEBX ► Intel(R) AMT Configuration

Unconfigure Network Access

Under the **Intel(R) AMT Configuration** menu, select **Unconfigure Network Access** and press Enter, and then press Enter to fully deactivate the ME network connection and reset configuration to factory default. Press Y to confirm or N to abort.

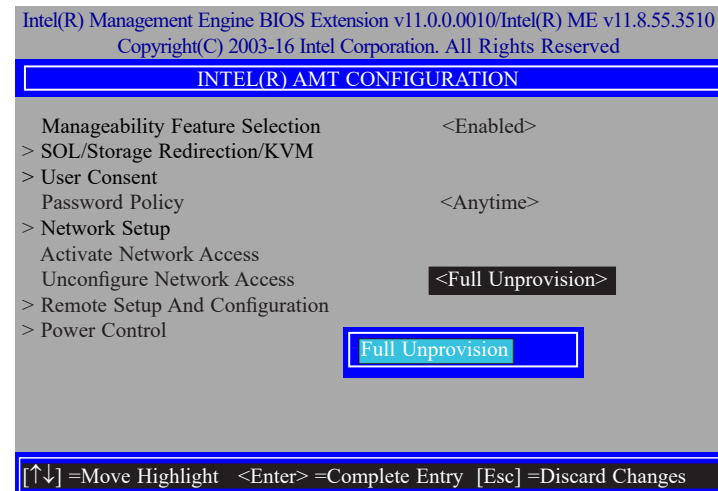

► MEBX ► Intel(R) AMT Configuration

> Remote Setup And Configuration

Under the **Intel(R) AMT Configuration** menu, select **Remote Setup And Configuration** then press Enter.

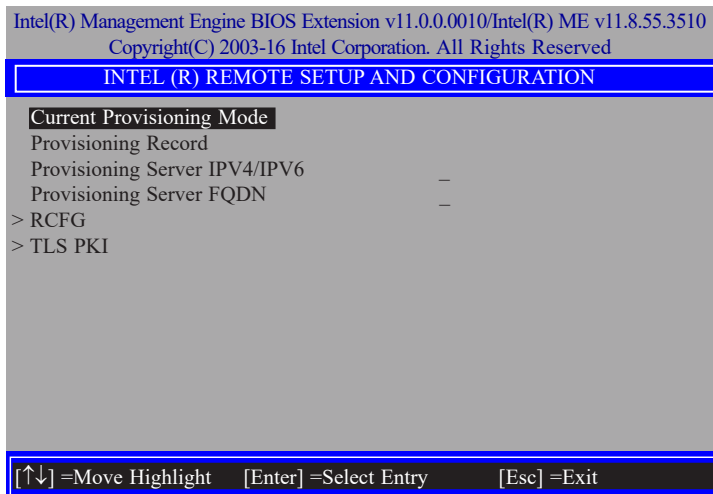
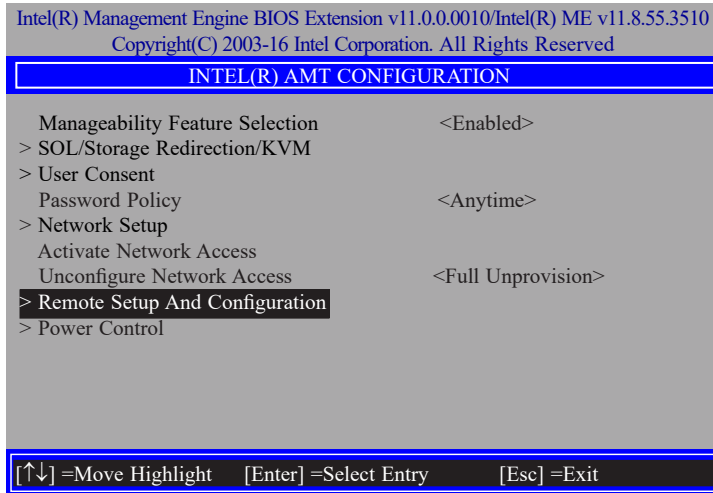

Current Provisioning Mode

The current mode — Public Key Infrastructure (PKI) — is displayed.

Provisioning Mode: PKI

Provisioning Record

Press Enter to view the record.

Provision Record is not present

Provisioning Server IPV4/IPV6

Enter the address of the server then press Enter, and then insert the TCP/UDP port number.

Provisioning server address

Port number (0-65535)

Provisioning Server FQDN

Enter the Fully Qualified Domain Name (FQDN) of the server and then press Enter.

Enter FQDN of provisioning server

► MEBX ► Intel(R) AMT Configuration

> Remote Setup And Configuration

> RCFG

Press Enter, select **Start Configuration**, and then press Enter to activate Remote Configuration (RCFG). Press Y to confirm or N to abort.

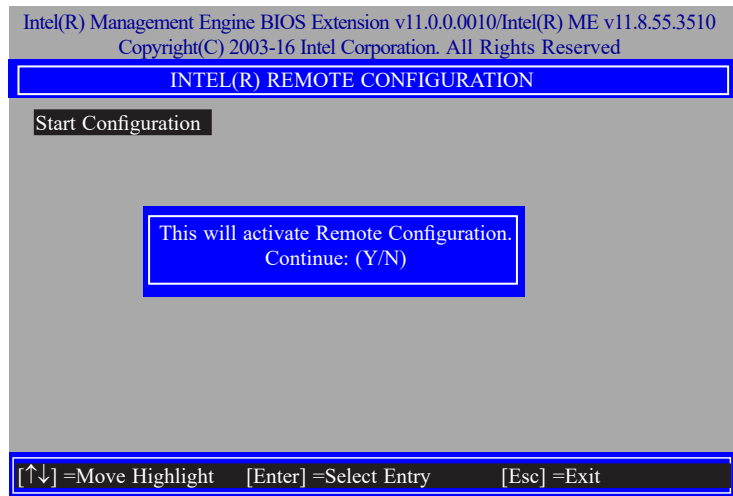

► MEBX ► Intel(R) AMT Configuration

> Remote Setup And Configuration

> TLS PKI

The system adopts PKI for encryption and authentication, and the TLS protocol for communication security to ensure remote configuration safety.

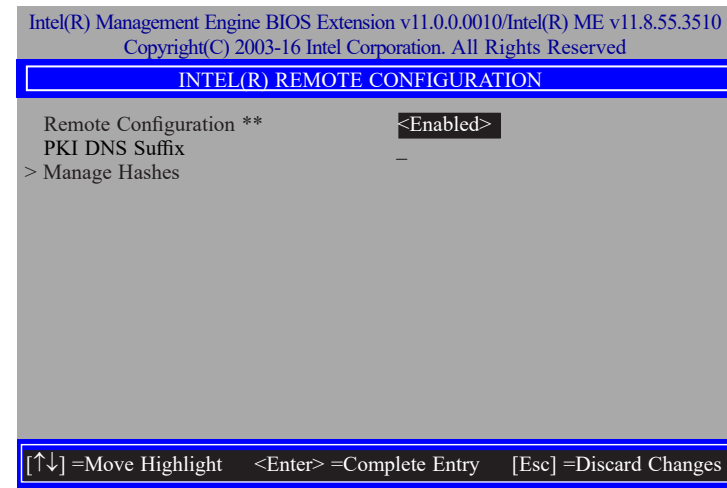

Remote Configuration **

Select **Enabled** or **Disabled** then press Enter.



PKI DNS Suffix

Specify the DNS Suffix of the PKI server, and then press Enter.



► MEBX ► Intel(R) AMT Configuration

> Remote Setup And Configuration > TLS PKI

> Manage Hashes

Select the hash name then press Insert to enter custom hash certificate name, press Delete to delete hash, press Enter to view hash information, press + to activate or deactivate hash, and press Esc to exit.

Intel(R) Management Engine BIOS Extension v11.0.0.0010/Intel(R) ME v11.8.55.3510
Copyright(C) 2003-16 Intel Corporation. All Rights Reserved

INTEL(R) REMOTE CONFIGURATION

Hash Name	Active	Default	Algorithm
VeriSign Class 3	Active: [*]	Default: [*]	SHA256
VeriSign Class 3	Active: [*]	Default: [*]	SHA256
Go Daddy Class 2	Active: [*]	Default: [*]	SHA256
Comodo AAA CA	Active: [*]	Default: [*]	SHA256
Starfield Class 2	Active: [*]	Default: [*]	SHA256
VeriSign Class 3	Active: [*]	Default: [*]	SHA256
VeriSign Class 3	Active: [*]	Default: [*]	SHA256
VeriSign Class 3	Active: [*]	Default: [*]	SHA256
GTE CyberTrust G1	Active: [*]	Default: [*]	SHA256
Baltimore Cyber Tr	Active: [*]	Default: [*]	SHA256
Cyber Trust Global	Active: [*]	Default: [*]	SHA256
Verizon Global Ro	Active: [*]	Default: [*]	SHA256
Entrust. net CA (2	Active: [*]	Default: [*]	SHA256
Entrust Root CA	Active: [*]	Default: [*]	SHA256
VeriSign Universa	Active: [*]	Default: [*]	SHA256
Go Daddy Root CA	Active: [*]	Default: [*]	SHA256
Entrust Root CA -	Active: [*]	Default: [*]	SHA256
Startfield Root CA	Active: [*]	Default: [*]	SHA256

[Ins] =Add New Hash [Delete] =Delete Hash [+] =Activate Hash
[↑↓] =Move Highlight [Enter] =View Hash [Esc] =Exit

► MEBX ► Intel(R) AMT Configuration

> Power Control

Under the **Intel(R) AMT Configuration** menu, select **Power Control** then press Enter.

Intel(R) Management Engine BIOS Extension v11.0.0.0010/Intel(R) ME v11.8.55.3510
Copyright(C) 2003-16 Intel Corporation. All Rights Reserved

INTEL(R) AMT POWER CONTROL

These configurations are effective only after AMT provisioning has started

Intel(R) AMT ON in Host Sleep States <Desktop: ON in S0, ME Wake in S3, S4-5>

Idle Timeout 65535

[↑↓] =Move Highlight <Enter> =Complete Entry [Esc] =Discard Changes

Intel(R) AMT ON in Host Sleep States

Select an option and then press Enter.

Desktop: ON in S0
Desktop: ON in S0, ME Wake in S3, S4-5

Idle Timeout

Enter a timeout value and press Enter.

Timeout Value (1-65535)
65535

► **MEBX****MEBx Exit**

Under the **Main Menu**, select **MEBx Exit** and then press Enter. Press Y to confirm or N to abort.

