



WM342-KD330/KD331

**Desktop Box IPC
User's Manual**

Copyright

This publication contains information that is protected by copyright. No part of it may be reproduced in any form or by any means or used to make any transformation/adaptation without the prior written permission from the copyright holders.

This publication is provided for informational purposes only. The manufacturer makes no representations or warranties with respect to the contents or use of this manual and specifically disclaims any express or implied warranties of merchantability or fitness for any particular purpose. The user will assume the entire risk of the use or the results of the use of this document. Further, the manufacturer reserves the right to revise this publication and make changes to its contents at any time, without obligation to notify any person or entity of such revisions or changes.

Changes after the publication's first release will be based on the product's revision. The website will always provide the most updated information.

© 2019. All Rights Reserved.

Trademarks

Product names or trademarks appearing in this manual are for identification purpose only and are the properties of the respective owners.

FCC and DOC Statement on Class A

This equipment has been tested and found to comply with the limits for a Class A digital device, pursuant to Part 15 of the FCC rules. These limits are designed to provide reasonable protection against harmful interference when the equipment is operated in a residential installation. This equipment generates, uses and can radiate radio frequency energy and, if not installed and used in accordance with the instruction manual, may cause harmful interference to radio communications. However, there is no guarantee that interference will not occur in a particular installation. If this equipment does cause harmful interference to radio or television reception, which can be determined by turning the equipment off and on, the user is encouraged to try to correct the interference by one or more of the following measures:

- Reorient or relocate the receiving antenna.
- Increase the separation between the equipment and the receiver.
- Connect the equipment into an outlet on a circuit different from that to which the receiver is connected.
- Consult the dealer or an experienced radio TV technician for help.

Notice:

1. The changes or modifications not expressly approved by the party responsible for compliance could void the user's authority to operate the equipment.
2. Shielded interface cables must be used in order to comply with the emission limits.

Table of Contents

Copyright	2	SATA (Serial ATA) Connectors.....	31
Trademarks	2	COM (Serial) Ports.....	32
FCC and DOC Statement on Class A	2	USB Ports.....	33
About this Manual	4	Cooling Fan Connectors.....	34
Warranty	4	Chassis Intrusion Connector	35
Static Electricity Precautions	4	LPC Connector.....	36
Safety Measures	4	Power Connectors.....	37
Safety Precautions	5	SMBus Connector	38
About the Package	5	Front Panel Connector	39
Before Using the System	5	Expansion Slots	40
Chapter 1 - Introduction	6	Standby Power LED	41
Chapter 2 - Getting Started	12	Battery.....	41
Chapter 3 - Installing Devices	13	LAN LED	42
Chapter 4 - Jumper Settings	20	Chapter 6 - Mounting Options	43
Clear CMOS.....	20	Chapter 7 - BIOS Setup	45
Serial Port RS232/422/485 Select	21	Overview	45
Serial Port Power Select.....	23	Insyde BIOS Setup Utility.....	46
Mini PCIe/mSATA Signal Select (for KD330-Q170 only)	24	Main	46
Chapter 5 - Ports and Connectors	25	Advanced	46
Rear Panel I/O Ports	25	UEFI Device Manager	53
PS/2 Keyboard/Mouse Port.....	25	Security.....	58
COM (Serial) Ports	26	Boot.....	59
Graphics Interfaces.....	26	Exit.....	60
RJ45 LAN Ports.....	27	Updating the BIOS.....	61
USB Ports.....	27	Notice: BIOS SPI ROM	61
Audio	28	Chapter 8 - Supported Software	62
I/O Connectors.....	28	Chapter 9 - RAID	70
Front Audio Connector (for WM342-KD331 only)	28	Chapter 10 - Intel AMT Settings	74
S/PDIF Connector	29		
Digital I/O and Power Connector	30		

About this Manual

An electronic file of this manual is included in the CD. To view the user's manual in the CD, insert the CD into a CD-ROM drive. The auto-run screen (Main Board Utility CD) will appear. Click "User's Manual" on the main menu.

Warranty

1. Warranty does not cover damages or failures that arised from misuse of the product, inability to use the product, unauthorized replacement or alteration of components and product specifications.
2. The warranty is void if the product has been subjected to physical abuse, improper installation, modification, accidents or unauthorized repair of the product.
3. Unless otherwise instructed in this user's manual, the user may not, under any circumstances, attempt to perform service, adjustments or repairs on the product, whether in or out of warranty. It must be returned to the purchase point, factory or authorized service agency for all such work.
4. We will not be liable for any indirect, special, incidental or consequential damages to the product that has been modified or altered.

Static Electricity Precautions

It is quite easy to inadvertently damage your PC, system board, components or devices even before installing them in your system unit. Static electrical discharge can damage computer components without causing any signs of physical damage. You must take extra care in handling them to ensure against electrostatic build-up.

1. To prevent electrostatic build-up, leave the system board in its anti-static bag until you are ready to install it.
2. Wear an antistatic wrist strap.
3. Do all preparation work on a static-free surface.
4. Hold the device only by its edges. Be careful not to touch any of the components, contacts or connections.
5. Avoid touching the pins or contacts on all modules and connectors. Hold modules or connectors by their ends.



Important:

Electrostatic discharge (ESD) can damage your processor, disk drive and other components. Perform the upgrade instruction procedures described at an ESD workstation only. If such a station is not available, you can provide some ESD protection by wearing an antistatic wrist strap and attaching it to a metal part of the system chassis. If a wrist strap is unavailable, establish and maintain contact with the system chassis throughout any procedures requiring ESD protection.

Safety Measures

To avoid damage to the system:

- Use the correct AC input voltage range.

To reduce the risk of electric shock:

- Unplug the power cord before removing the system chassis cover for installation or servicing. After installation or servicing, cover the system chassis before plugging the power cord.

Battery:

- Danger of explosion if battery incorrectly replaced.
- Replace only with the same or equivalent type recommend by the manufacturer.
- Dispose of used batteries according to local ordinance.

Safety Precautions

- Use the correct DC input voltage range.
- Unplug the power cord before removing the system chassis cover for installation or servicing. After installation or servicing, cover the system chassis before plugging the power cord.
- Danger of explosion if battery incorrectly replaced.
- Replace only with the same or equivalent type recommend by the manufacturer.
- Dispose of used batteries according to local ordinance.
- Keep this system away from humidity.
- Place the system on a stable surface. Dropping it or letting it fall may cause damage.
- The openings on the system are for air ventilation to protect the system from overheating. **DO NOT COVER THE OPENINGS.**
- Place the power cord in such a way that it will not be stepped on. Do not place anything on top of the power cord. Use a power cord that has been approved for use with the system and that it matches the voltage and current marked on the system's electrical range label.
- If the system will not be used for a long time, disconnect it from the power source to avoid damage by transient overvoltage.
- If one of the following occurs, consult a service personnel:
 - The power cord or plug is damaged.
 - Liquid has penetrated the system.
 - The system has been exposed to moisture.
 - The system is not working properly.
 - The system dropped or is damaged.
 - The system has obvious signs of breakage.
- The unit uses a three-wire ground cable which is equipped with a third pin to ground the unit and prevent electric shock. Do not defeat the purpose of this pin. If your outlet does not support this kind of plug, contact your electrician to replace the outlet.
- Disconnect the system from the DC outlet before cleaning. Use a damp cloth. Do not use liquid or spray detergents for cleaning.

About the Package

The package contains the following items. If any of these items are missing or damaged, please contact your dealer or sales representative for assistance.

- 1 WM342-KD330 or WM342-KD331 System Unit
- 1 CPU cooler
- 1 SATA Data Cable (Length: 650mm)
- 4 HDD Screws
- 1 PSU Flex ATX 150W/250W/350W/400W/500W (250W Default)
- 1 System Fan

Optional Items

- Power Cord
- 3.5" HDD Tray Kit

The board and accessories in the package may not come similar to the information listed above. This may differ in accordance to the sales region or models in which it was sold. For more information about the standard package in your region, please contact your dealer or sales representative.

Before Using the System

Before powering-on the system, prepare the basic system components.

If you are installing the system board in a new system, you will need at least the following internal components.

- CPU and Memory module
- Storage devices such as hard disk drive, CD-ROM, etc.

You will also need external system peripherals you intend to use which will normally include at least a keyboard, a mouse and a video display monitor.

Chapter 1 - Introduction

Overview



Front View



Rear View

Key Features

Model Name	WM342-KD
Processor	6th/7th Generation Intel® Core™ processors
Chipset	Intel® C236 / Q170 / H110 Chipset
LAN	2 LAN ports (for WM342-KD330) 4 LAN ports (for WM342-KD331)
COM	1 COM port
Displays	1 x VGA 1 x DVI-D (DVI-I connector) 1 x DP++
USB	4 USB 3.0 ports + 2 USB 2.0 ports
Audio	Mic-in and Line-out (for WM342-KD330 only)

Specifications

System	Processor	<p>6th Generation Intel® Core™ Processors (LGA 1151 Socket)</p> <p>Intel® Xeon® Processor E3-1275 v5, Quad Core, 8M Cache, 3.6GHz (4.0GHz), 80W (available for KD331-C236 only)</p> <p>Intel® Xeon® Processor E3-1225 v5, Quad Core, 6M Cache, 3.3GHz (3.7GHz), 80W (available for KD331-C236 only)</p> <p>Intel® Xeon® Processor E3-1268L v5, Quad Core, 8M Cache, 2.4GHz (3.4GHz), 35W (available for KD331-C236 only)</p> <p>Intel® Core™ i7-6700 Processor, Quad Core, 8M Cache, 3.4GHz (4.0GHz), 65W</p> <p>Intel® Core™ i7-6700TE Processor, Quad Core, 8M Cache, 2.4GHz (3.4GHz), 35W</p> <p>Intel® Core™ i5-6500 Processor, Quad Core, 6M Cache, 3.2GHz (3.6GHz), 65W</p> <p>Intel® Core™ i5-6500TE Processor, Quad Core, 6M Cache, 2.3GHz (3.3GHz), 35W</p> <p>Intel® Core™ i3-6100 Processor, Dual Core, 4M Cache, 65W</p> <p>Intel® Core™ i3-6100TE Processor, Dual Core, 4M Cache, 2.7GHz, 35W</p> <p>Intel® Pentium® Processor G4400, Dual Core, 3M Cache, 3.3GHz, 65W</p> <p>Intel® Pentium® Processor G4400TE, Dual Core, 3M Cache, 2.9GHz, 35W</p> <p>Intel® Celeron® Processor G3900, Dual Core, 2M Cache, 2.8GHz, 65W</p> <p>Intel® Celeron® Processor G3900TE, Dual Core, 2M Cache, 2.6GHz, 35W</p> <p>7th Generation Intel® Core™ Processors (LGA 1151 Socket)</p> <p>Intel® Xeon® E3-1275 v6, Quad Core, 8M Cache, 3.8GHz (4.2GHz), 80W (available for KD331-C236 only)</p> <p>Intel® Core™ i7-7700 Processor, Quad Core, 8M Cache, 3.6GHz (4.2GHz), 65W</p> <p>Intel® Core™ i5-7500 Processor, Quad Core, 6M Cache, 3.4GHz (3.8GHz), 65W</p> <p>Intel® Core™ i3-7101E Processor, Dual Core, 3M Cache, 3.9GHz, 65W ECC memory Supported)</p>

	Chipset	<p>WM342-KD330</p> <p>KD330-Q170: Intel® Q170 Chipset KD330-H110: Intel® H110 Chipset</p> <p>WM342-KD331</p> <p>KD331-C236: Intel® C236 Chipset KD331-Q170: Intel® Q170 Chipset</p>
	Memory	<p>WM342-KD331 (KD331-C236)</p> <p>Four 288-pin ECC/Non-ECC DIMM up to 64GB, Dual Channel DDR4 2133/2400 MHz</p> <p>WM342-KD331 (KD331-Q170)</p> <p>Four 288-pin DIMM up to 64GB, Dual Channel DDR4 2133/2400 MHz</p> <p>WM342-KD330 (KD330-Q170)</p> <p>Four 288-pin DIMM up to 64GB, dual channel DDR4 2133/2400 MHz</p> <p>WM342-KD330 (KD330-H110):</p> <p>Two 288-pin DIMM up to 32GB, dual channel DDR4 2133/2400 MHz</p>
Graphics	Controller	Intel® HD Gen 9 Graphics
	Feature	<p>OpenGL 5.0, DirectX 12, OpenCL 2.1</p> <p>HW Decode: AVC/H.264, MPEG2, VC1/WMV9, JPEG/MJPEG, HEVC/H265, VP8, VP9</p> <p>HW Encode: MPEG2, AVC/H264, JPEG, HEVC/H265, VP8, VP9</p>
	Display	<p>1 x VGA</p> <p>1 x DVI-D (DVI-I connector)</p> <p>1 x DP++</p> <p>VGA: resolution up to 1920x1200 @ 60Hz</p> <p>DVI-D: resolution up to 1920x1200 @ 60Hz</p> <p>DP++: resolution up to 4096x2304 @ 60Hz</p>
	Triple Display	VGA + DVI-D + DP++
Storage	External	1 or 2 x 2.5" SATA 3.0 Drive Bays (1 x 2.5" SATA drive bay by default)
Expansion	Interface	<p>WM342-KD330</p> <p>1 x PCIe x16 (Gen 3)</p> <p>1 x PCI</p> <p>1 x Full-size Mini PCIe (USB/PCIe/mSATA, PCIe by default) (only for KD330-Q170 with the Intel® Q170 Chipset)</p> <p>Additional internal slot without external access from the chassis slot: <i>PCIe x4</i></p> <p>WM342-KD331</p> <p>1 x PCIe x16 (Gen 3)</p> <p>1 x PCIe x4 (Gen 3)</p> <p>1 x M.2 Key M (2260/2280) (Intel® Optane™ memory support only for KD331-C236 with the Intel® C236 Chipset)</p> <p>Additional internal slot without external access from the chassis slot: <i>PCIe x8</i> <i>PCIe x4</i></p>

Audio	Codec	Realtek ALC888S-VD2-GR
ETHERNET	Controller	WM342-KD330 KD330-Q170: 1 x Intel® I211AT PCIe (10/100/1000Mbps) 1 x Intel® I219LM PCIe with iAMT11.0 (10/100/1000Mbps)*
		WM342-KD331 KD330-H110: 1 x Intel® I211AT PCIe (10/100/1000Mbps) 1 x Intel® I219V PCIe (10/100/1000Mbps) WM342-KD331 3 x Intel® I211AT PCIe (10/100/1000Mbps) 1 x Intel® I219LM PCIe with iAMT11.0 (10/100/1000Mbps)*
LED	Indicators	1 x Power LED 1 x HDD LED
REAR I/O	Ethernet	WM342-KD330 2 x GbE (RJ-45) WM342-KD331 4 x GbE (RJ-45)
	Serial	1 x RS-232/422/485 (RS-232 w/ power) (DB-9 connector)
	USB	4 x USB 3.0 2 x USB 2.0
	PS/2	1 x PS/2 (mini-DIN-6)
	Display	1 x VGA 1 x DVI-D (DVI-I connector) 1 x DP++
	Audio	1 x Line-out, 1 x Mic-in (WM342-KD330 only)
	Buttons	1 x Power Button, 1 x Reset Button
Cooling	Fan	1 x System Fan
WatchDog Timer	Output & Interval	System Reset, Programmable via Software from 1 to 255 Seconds
Power	Supply	Flex ATX 250W (or optional 150/350/400/500W)
OS Support and BIOS	OS	Windows 10 IoT Enterprise 64-bit
	BIOS	Insyde SPI 128Mbit

Environment	Operating Temperature	0 to 45°C
	Storage Temperature	0 to 60°C
	Relative Humidity	5 to 95% RH (non-condensing)
Standards & Certifications	Shock	Operating: 3G Non-operating: 5G
	Vibration	Operating: Random 5~500Hz 0.5G Non-operating: Sine 10~500Hz 1.5G
	Package Drop	ISTA Project 1A
Mechanism	Construction	Sheet Metal
	Mounting	Wall Mount
	Dimensions	306.6 mm x 132.1 mm x 301.9 mm
	Weight	TBD

Note: *SKUs with the Intel® H110 chipset or the Intel® Core™ i3, Celeron® and Pentium® processors do not support iAMT.

Getting to Know the WM342-KD

Front View



WM342-KD331

- 1 x PCIe x16 (Gen 3)
- 1 x PCIe x4 (Gen 3)

Rear View

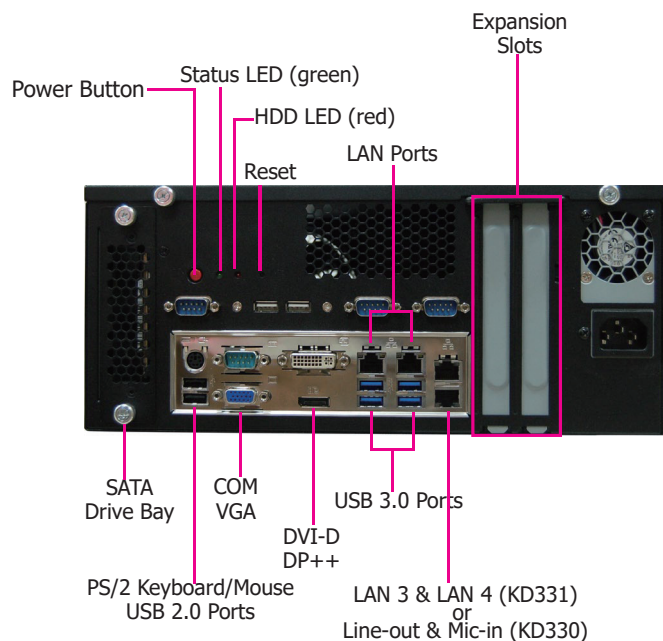

DVI-D (DVI-I connector)/DP++/VGA Port

Connects the DVI-D (DVI-I signal)/DP++/VGA connector of an LCD monitor.

COM Port

Connects serial devices. COM 1 can be selected among RS232, RS422 and RS485 as well as between RS232 and RS232 with power via jumper settings.

USB 3.0 Ports

Connect USB 3.0 devices and devices based on USB 2.0 and 1.1/1.0 versions.

USB 2.0 Ports

Connect USB 2.0 devices and devices based on USB 1.1/1.0 versions.

LAN Ports

Connect the system to a local area network. Note that the model with the KD330 mainboard has only two ports whereas the model with the KD331 mainboard has four ports.

Line-out/Mic-in (for WM342-KD330 only)

Connects an external speaker and microphone.

PS/2 KB/Mouse

Connects a PS/2 keyboard and mouse.

Expansion Slots

Provides PCIe or PCI expansion connectivity. Note that the model with the KD330 mainboard has one PCIe and one PCI expansion slots whereas the model with the KD331 mainboard has two PCIe expansion slots.

Power Button

Press to power on or off the system.

Status LED (Green)

Indicates system status.

Status LED			
ACPI state	S0	Sleep	S4, S5
LED Behavior	ON	Blinking	Off

HDD LED (Red)

Indicates the status of hard drives.

HDD LED		
HDD State	Disk access activity	Disk drives present or not present
LED Behavior	Blinking	Off

SATA Drive Bay

Inserts a SATA drive.

Mechanical Dimensions (WM342-KD330)

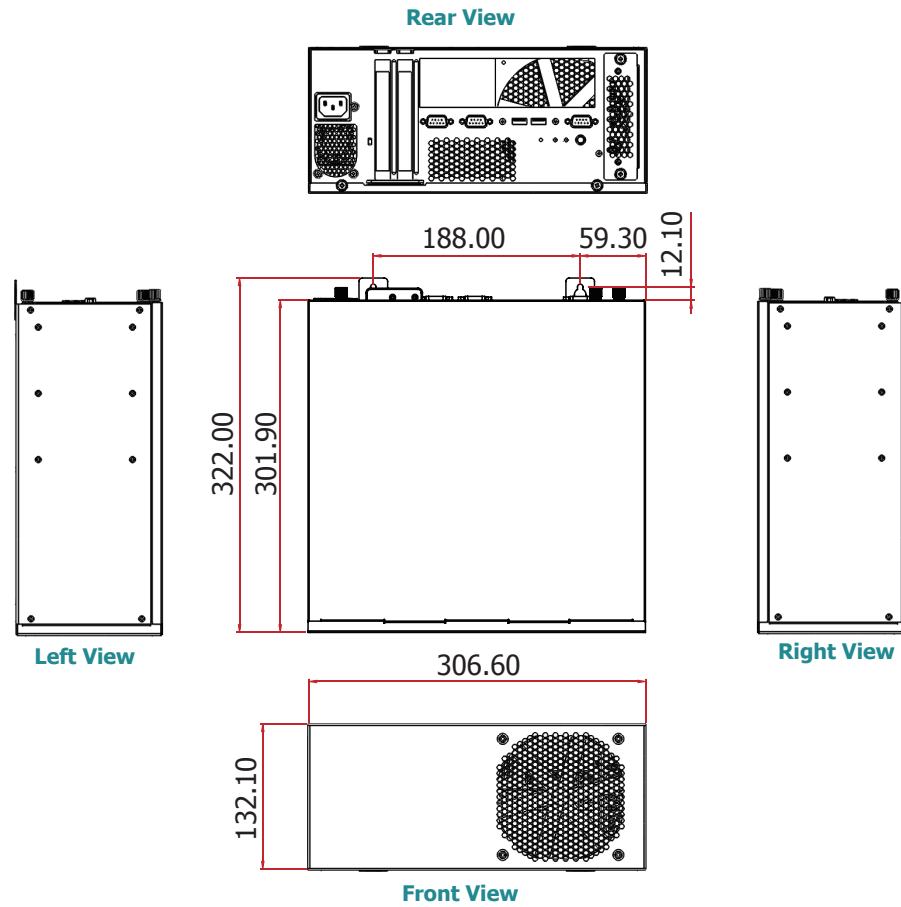

Mechanical Dimensions (WM342-KD331)

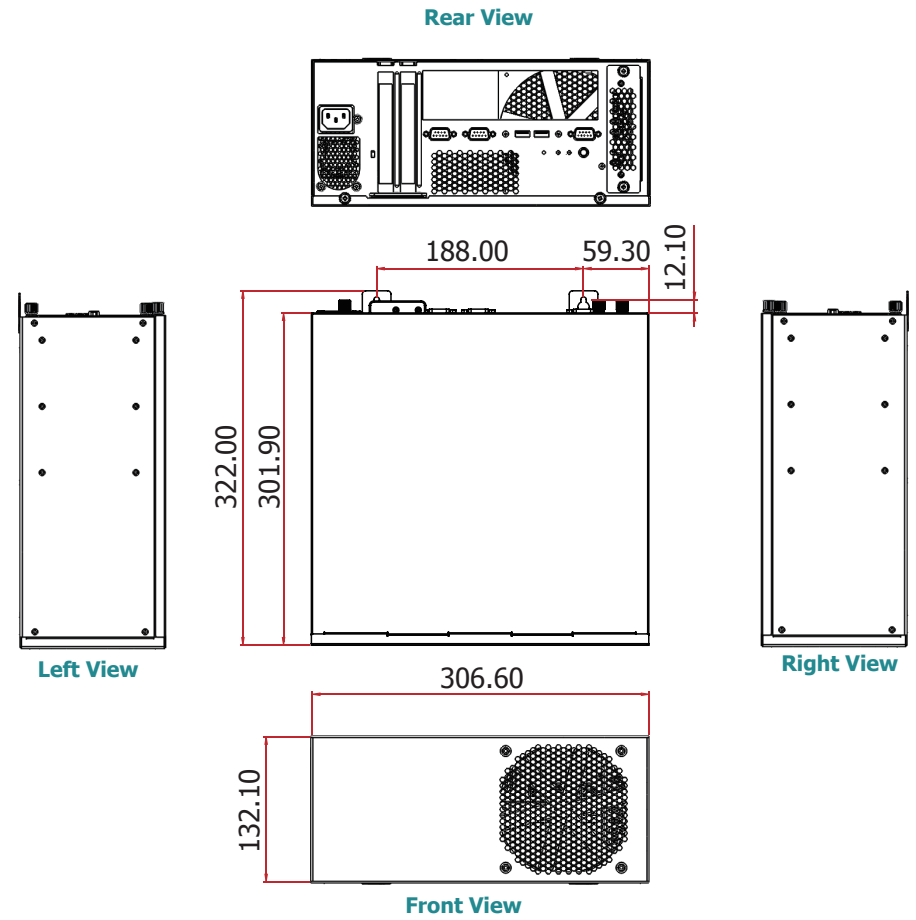

Motherboard Dimensions (KD330-Q170/KD330-H110)

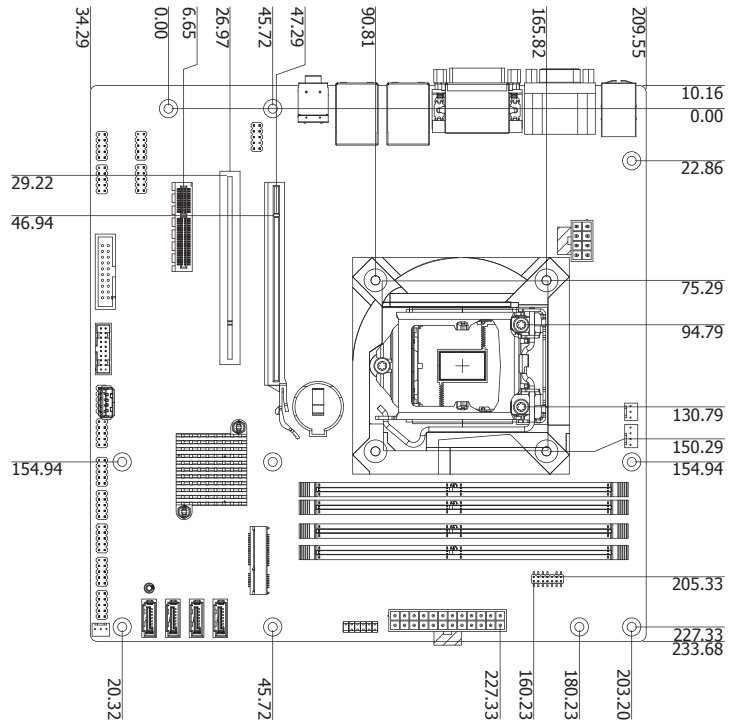

Motherboard Dimensions (KD331-C236/KD331-Q170)

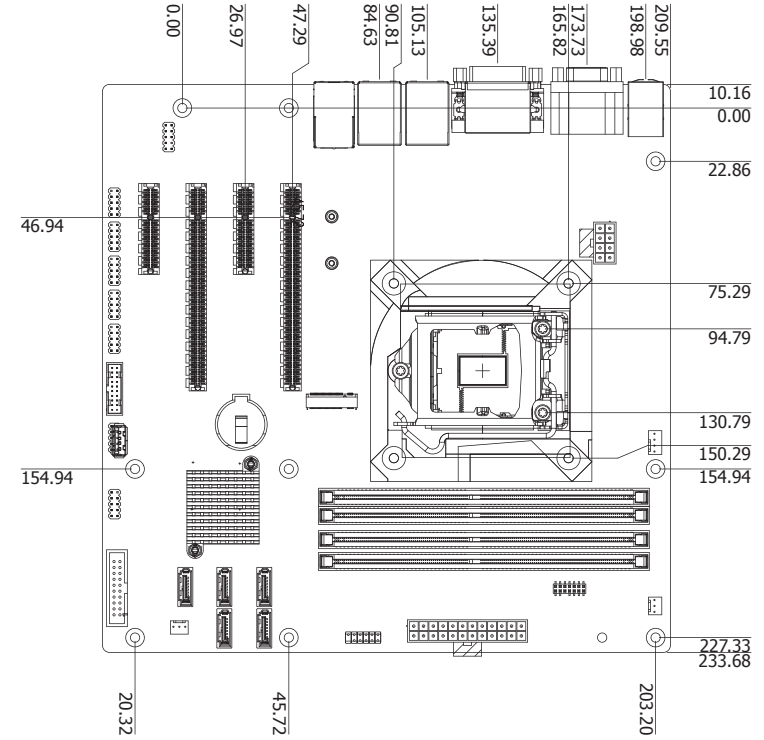

Chapter 2 - Getting Started

Preparing the System

Before you start using the system, you need the following items:

- SATA HDD/SSD
- M.2 card
- PCIe cards
- CPU

Installing Devices

The following devices can be installed in the system:

- DIMM
- Mini PCIe card
- M.2 card

Configuring the BIOS

To get you started, you may need to change configurations such as the date, time and the type of hard disk drive.

1. Power on the system.
2. After the memory test, the message "Press DEL to run setup" will appear on the screen. Press the Delete key to enter the BIOS setup utility.

Installing an Operating System

Depending on the method you choose to install your system, you may use a USB flash drive or install a CD-ROM drive to run the Operating System CD.

Make sure that a SATA drive or an M.2 card is already installed.

1. Refer to the following chapters for information on installing a SATA drive or an M.2 card.
2. Refer to your operating system manual for instructions on installing an operating system.

Installing the Drivers

The system package includes a CD disk. The CD includes drivers that must be installed to provide the best system performance. Refer to the Supported Software chapter for instructions on installing the drivers.

Chapter 3 - Installing Devices

Opening the Chassis

Please observe the following guidelines and follow the procedure to open the system.

1. Make sure the system and all other peripheral devices connected to it have been powered off.
2. Disconnect all power cords and cables.
3. Remove the top cover by uninstalling the thumb screws.



Installing a DIMM

The system is equipped with four DIMM sockets. Please use the following procedure to install a DIMM into the socket.

1. Align the notch on the DIMM with the tab in the DIMM connector.
2. Press down on the DIMM until the release tabs spring back to secure the DIMM in place.

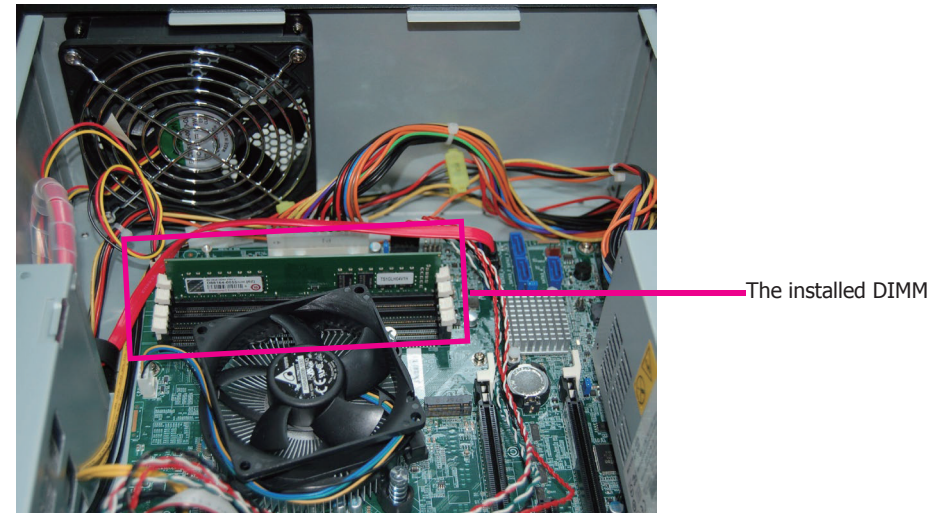

Notes:

1. The system is equipped with four DDR4 (dual channel) sockets. To enable dual-channel, populate DIMM sockets that belong to the same channel:
Channel A: DDR4_1 & DDR4_3
Channel B: DDR4_2 & DDR4_4
2. The DIMM sockets can only accommodate DDR4 memory modules. Please do not install other types of memory modules.
3. The WM342-KD330 (with the Intel® H110 Chipset) is equipped with only two DIMM sockets.

Installing a PCI or PCIe Expansion Card

Use the following procedure to install an expansion card:

1. Remove the mounting screws to uninstall the card slot bracket.

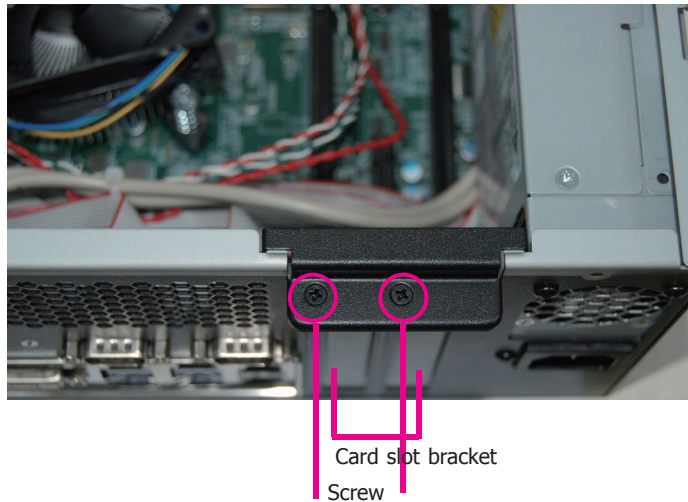

2. Insert the expansion card in the connector on the motherboard and press it down until secured.

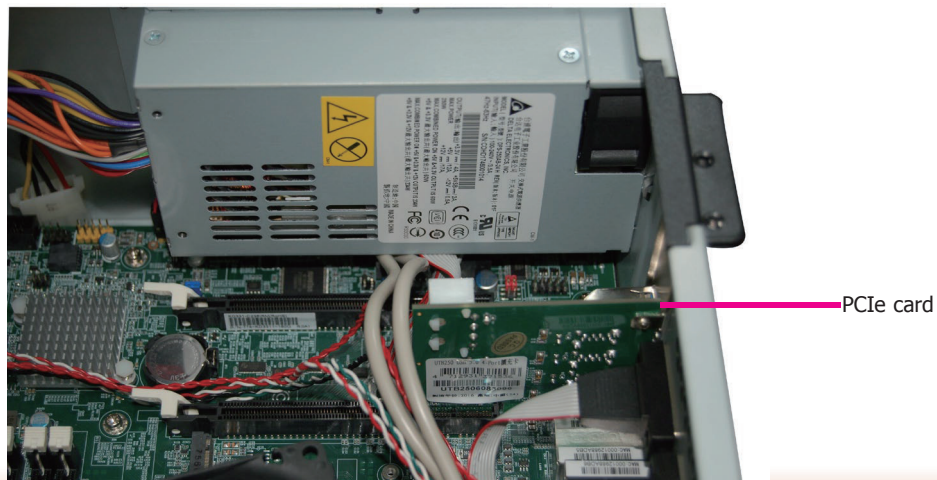

3. Reinstall the card slot bracket to secure the expansion card in place.

Rear View

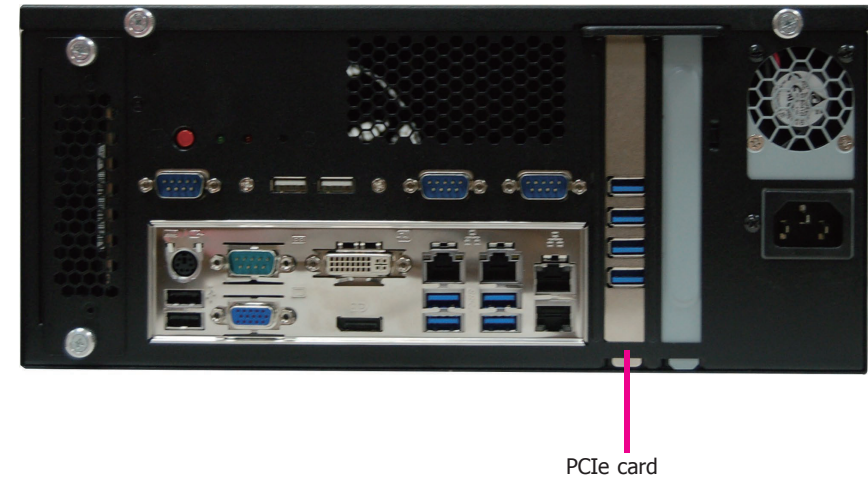

Notes:

1. The WM342-KD330 chassis slot can accommodate one PCIe x16 and one PCI slots.
2. The WM342-KD331 chassis slot can accommodate one PCIe x16 and one PCIe x4 slots.

Installing a Mini PCIe Card

The system board is equipped with one Mini PCIe slot that provides USB, PCI and mSATA interfaces.

1. Grasp the Mini PCIe card by its edges and align the notch in the connector of the PCIe card with the notch in the connector on the system board.

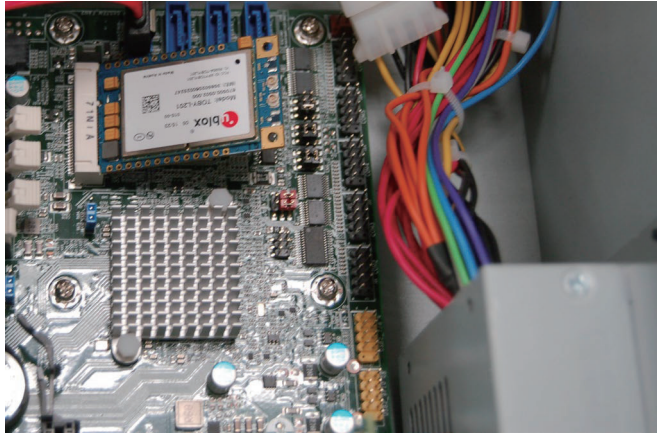

2. Push the Mini PCIe card down and use the provided mounting screws to secure the card on the system board.

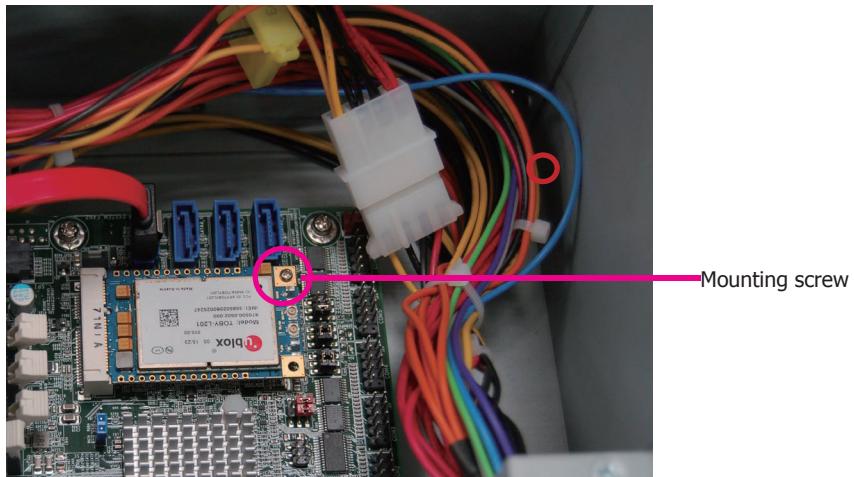

Note:

The Mini PCIe slot is available in WM342-KD330 (only with Intel® Q170 Chipset).

Installing an M.2 Card

The system is equipped with one M.2 socket, supporting both the M.2 22x60mm and 22x80mm (key M) form factors. Use the following procedure to install an M.2 card:

1. To install an M.2 type 2260 card, please install the standoff at the 60mm mounting position first.

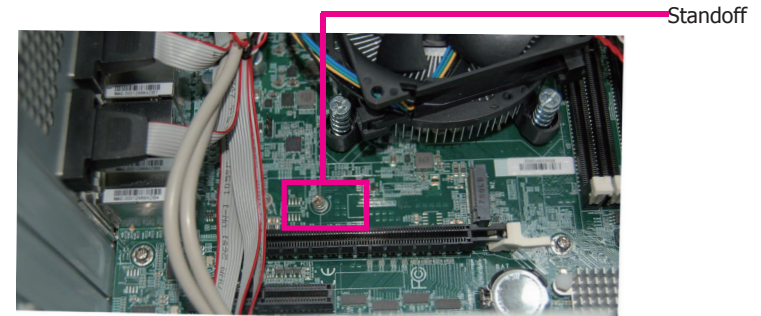

2. Align the notch at the edge of the M.2 card with the key in the connector.
3. Insert the M.2 card into the connector.

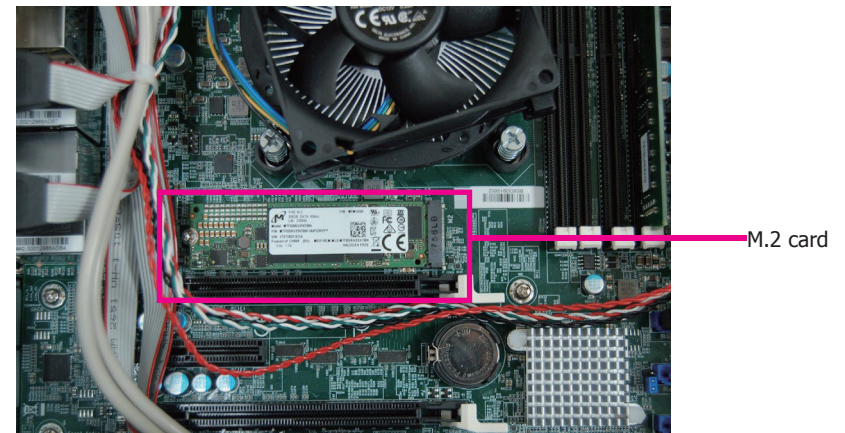

Note:

The M.2 slot is available in WM342-KD331 (with both Intel® C236 and Q170 chipsets) and the SKU with Intel® C236 chipset further supports Intel® Optane™ memory.

Installing a 2.5" SATA Drive

The system can accommodate two 2.5" SATA drives. Use the following procedure to install a SATA drive onto the system.

1. Remove the thumb screws that secure the HDD drive bay to the chassis and remove the drive bay.



2. Secure the hard drive to the drive bay. Align the mounting holes on the SATA drive with the mounting holes on the HDD drive bay. Use 4 mounting screws to install the hard drive onto the HDD drive bay.

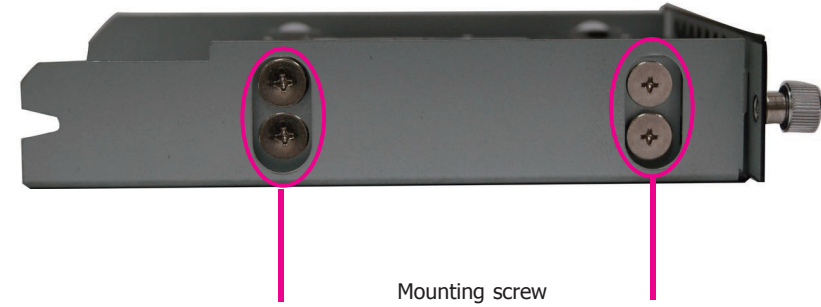
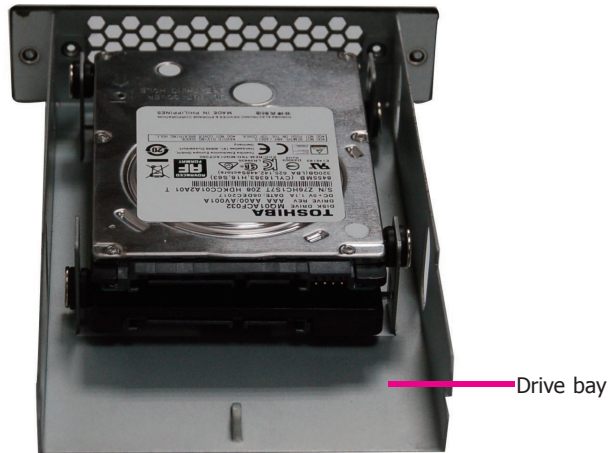

3. Slide the HDD drive bay back to the system and secure it with the thumb screws.
4. Connect the SATA data cable and power cable to the connectors on the SATA drive. And connect the other end of the SATA data cable on the motherboard.

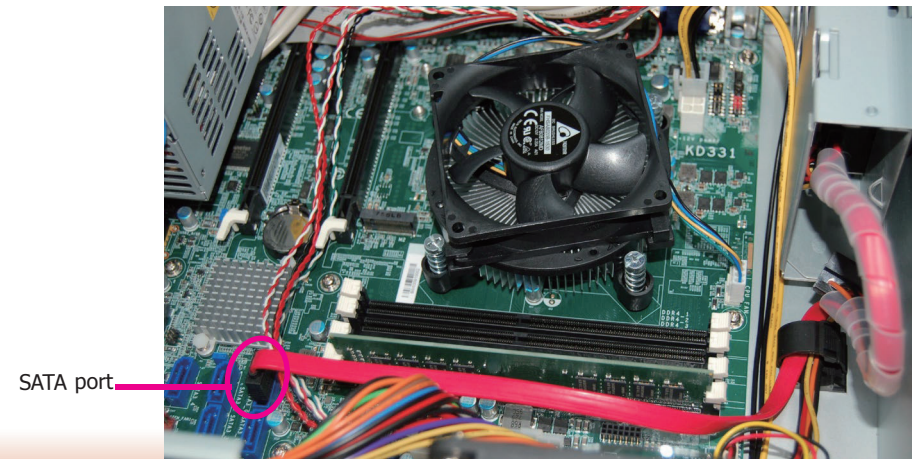
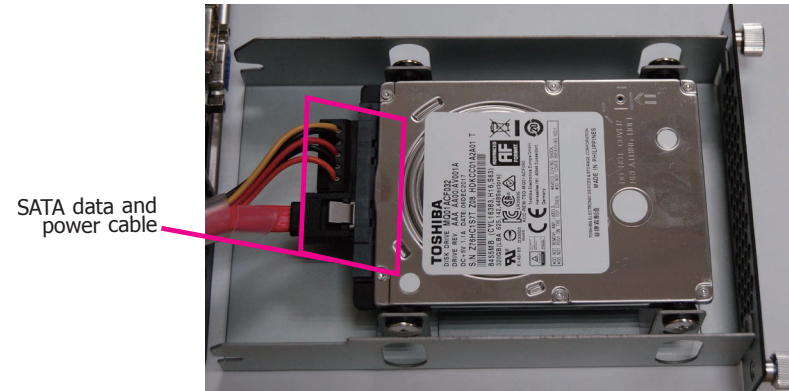

Installing a CPU

The system can accommodate a variety of CPUs that are supported by the LGA 1151 socket and compliant with the power specification. Please refer to the Chapter 1 for the supported CPU list.

1. Make sure the system and all other peripheral devices connected to it have been powered-off.
2. Disconnect all power cords and cables.
3. The system board is equipped with a surface mount LGA 1151 socket. This socket is exclusively designed for installing a LGA 1151 packaged Intel CPU.



Important:

1. Before you proceed, make sure (1) the LGA 1151 socket comes with a protective cap, (2) the cap is not damaged and (3) the socket's contact pins are not bent. If the cap is missing or the cap or contact pins are damaged, contact your dealer immediately.
2. Keep the protective cap. RMA requests will be accepted and processed only if the LGA 1151 socket comes with the protective cap.

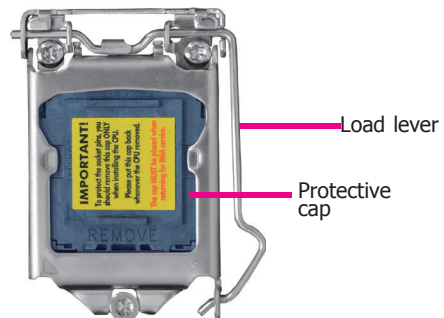

4. Unlock the socket by pushing the load lever down, move it sideways until it is released from the retention tab, and then lift the load lever up.

5. Remove the protective cap from the CPU socket. The cap is used to protect the CPU socket against dust and harmful particles. Remove the protective cap only to install the CPU.
6. Insert the CPU into the socket. The gold triangular mark on the CPU must align with the corner of the CPU socket as the photo shown below.
7. Unlock the socket by pushing the load lever down and moving it sideways until it is released from the retention tab and then lift the load lever up.

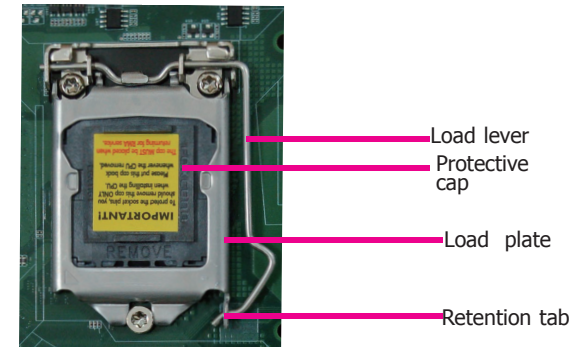

8. Insert the CPU into the socket. The gold triangular mark on the CPU must align with the corner of the CPU socket as shown below. The CPU's notch will at the same time fit into the socket's alignment key.

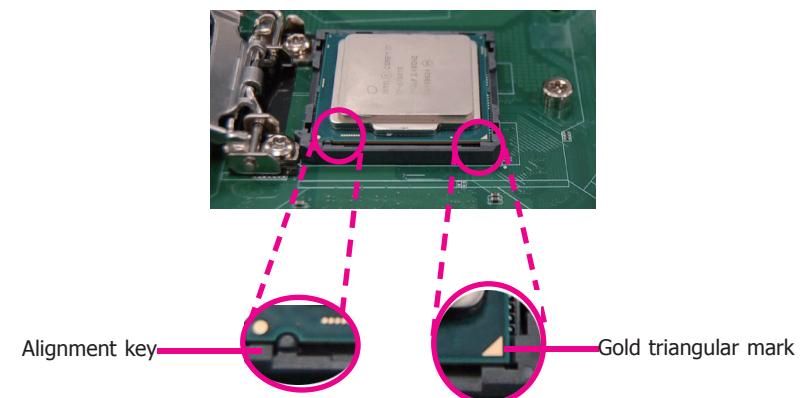

**Important:**

The CPU will fit in only one orientation and can easily be inserted without exerting any force.

9. Close the load plate and push the load lever down to lock it under the retention tab. While closing the load plate, slide the front edge of the load plate under the retention tab.

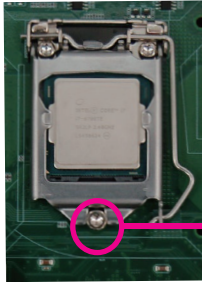

Retention knob

Installing the Fan and Heat Sink

The CPU must be kept cool by using a CPU fan with heat sink. Without sufficient air circulation across the CPU and heat sink, the CPU will overheat damaging both the CPU and system board.

**Note:**

A boxed Intel® processor already includes the CPU fan and heat sink assembly. If your CPU was purchased separately, make sure to only use Intel®-certified fan and heat sink.

1. Before you install the fan / heat sink, you must apply a thermal paste onto the top of the CPU. The thermal paste is usually supplied when you purchase the fan / heat sink assembly. Do not spread the paste all over the surface. When you later place the heat sink on top of the CPU, the compound will disperse evenly.

Some heat sinks come with a patch of pre-applied thermal paste. Do not apply thermal paste if the fan / heat sink already has a patch of thermal paste on its underside. Peel the strip that covers the paste before you place the fan / heat sink on top of the CPU.

2. Place the heat sink on top of the CPU. The 4 screw around the heat sink, which are used to secure the heat sink onto the system board, must match the 4 mounting holes around the socket.
3. Orient the heat sink such that the CPU fan's cable is nearest the CPU fan connector.

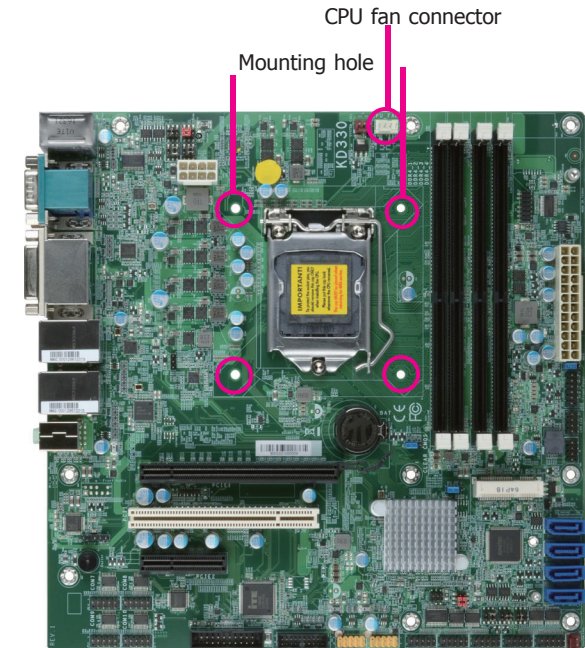

4. Rotate each screw that are diagonally across the heat sink. Perform the same procedure for the other screws.

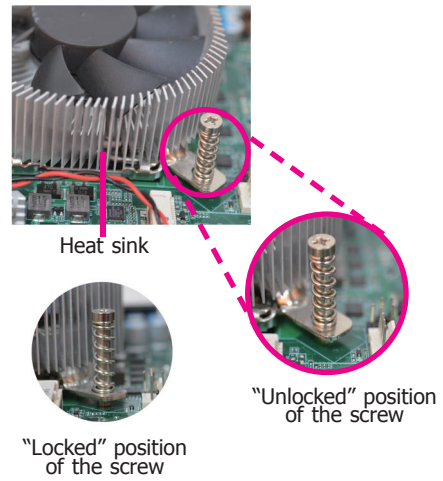

5. Connect the CPU fan's cable to the CPU fan connector on the system board.

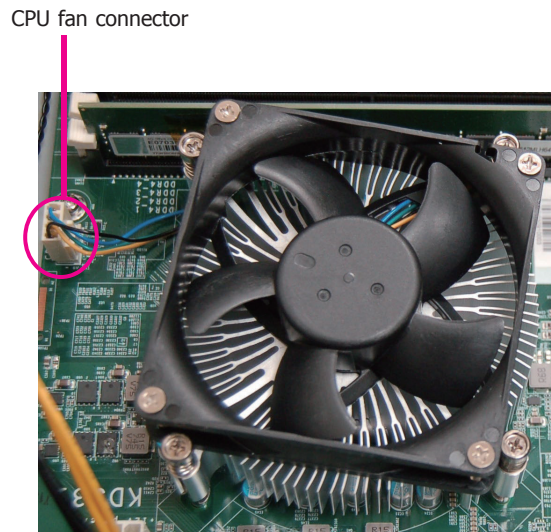

Chapter 4 - Jumper Settings

Clear CMOS WM342-KD330

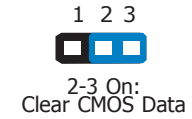
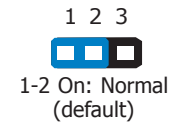
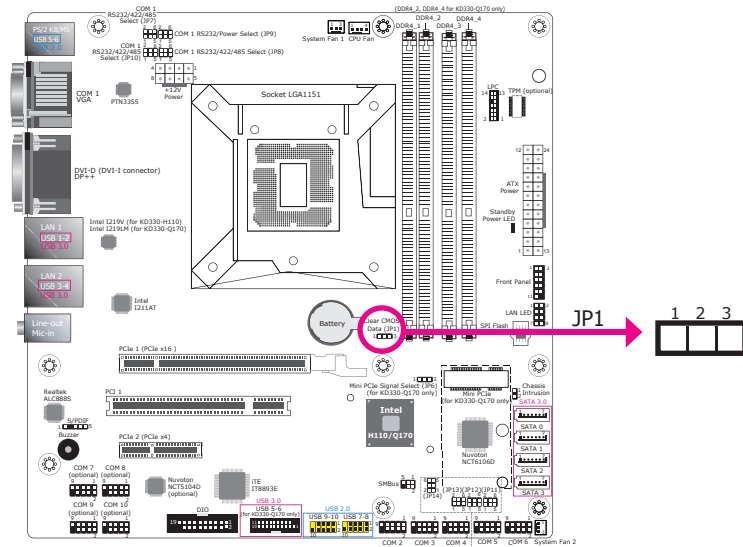

If you encounter the following situations, you can reconfigure the system with the default values stored in the ROM BIOS.

- a) CMOS data becomes corrupted.
- b) You forgot the supervisor or user password.

To load the default values stored in the ROM BIOS, please follow these steps below:

1. Power off the system and unplug the power cord.
2. Set the jumper pins 2 and 3 to On. Wait for a few seconds and set the jumper pins back to its default setting, pins 1 and 2 On.
3. Now plug the power cord and power on the system.

WM342-KD331

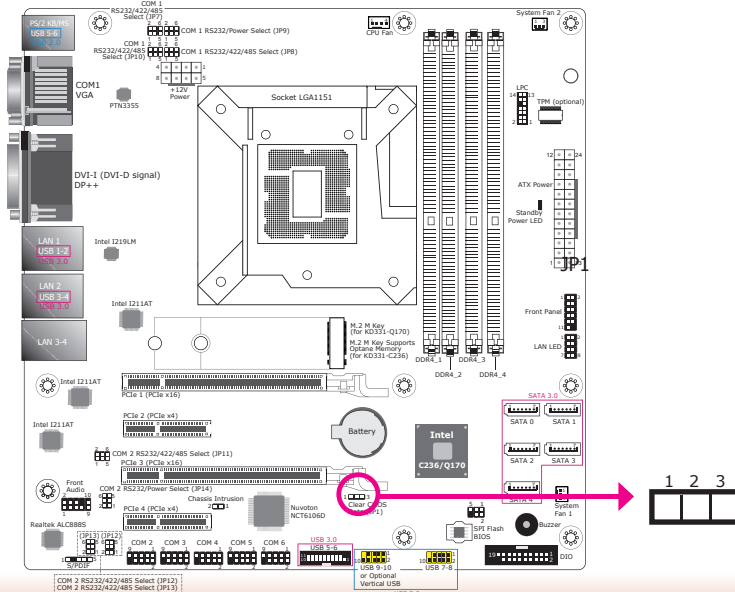

Serial Port RS232/422/485 Select

WM342-KD330

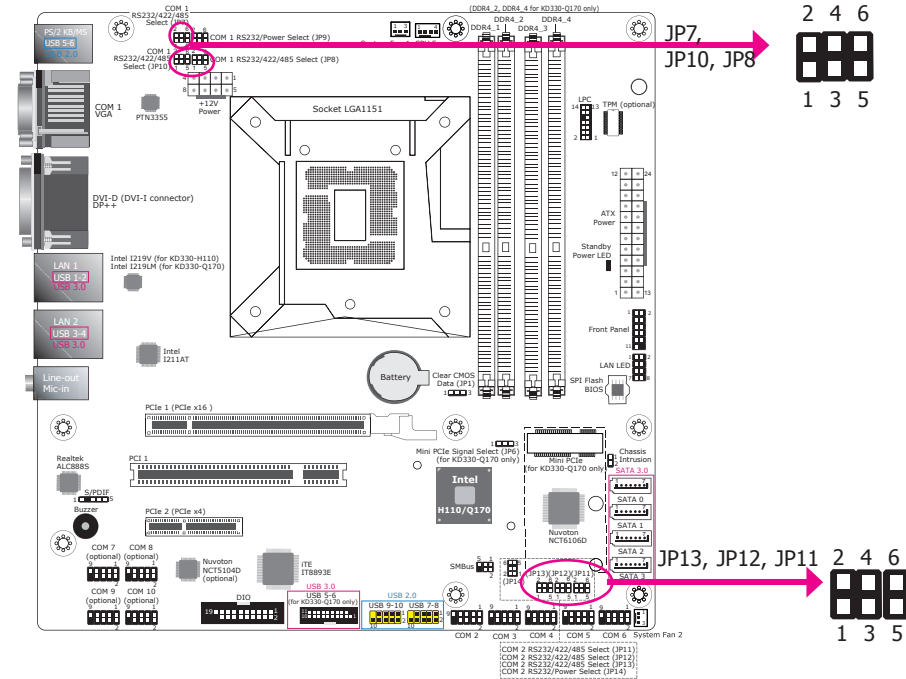

JP7, JP8, and JP10 (for COM 1) and JP11, JP12, and JP13 (for COM 2) are used to configure the COM ports to RS232, RS422 (full duplex) or RS485. The pin assignments of the COM ports will vary according to the jumpers' settings.

JP7 (COM 1) / JP11 (COM 2)



JP8 and JP10 (COM 1)



JP12 and JP13 (COM 2)



COM 1

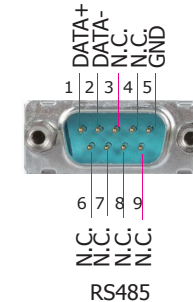
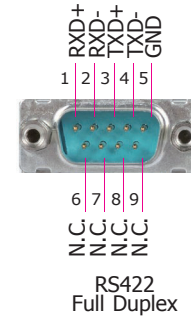
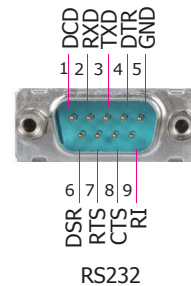

COM 2

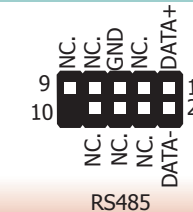
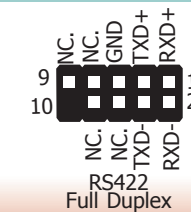
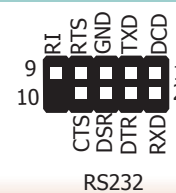

WM342-KD331

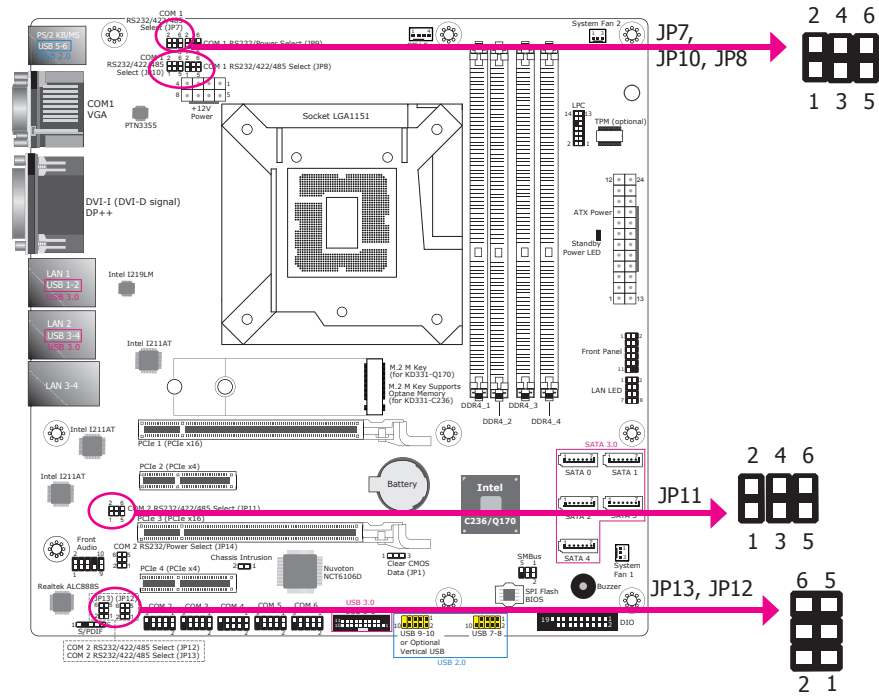

JP7, JP8, and JP10 (for COM1) and JP11, JP12, and JP13 (for COM2) are used to configure the COM ports to RS232, RS422 (full duplex) or RS485. The pin assignments of the COM ports will vary according to the jumpers' settings.

JP7 (COM 1) / JP11 (COM 2)

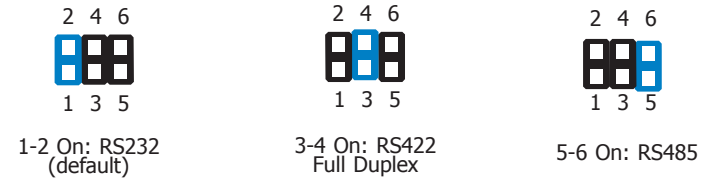

JP8 and JP10 (COM 1) JP12 and JP13 (COM 2)

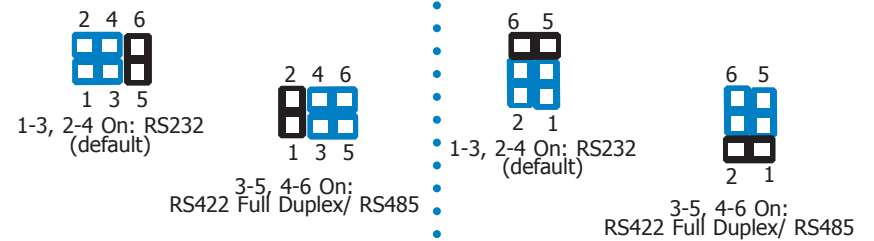

COM 1

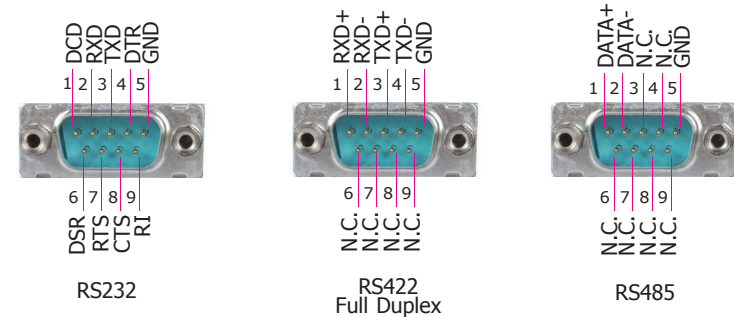

COM 2

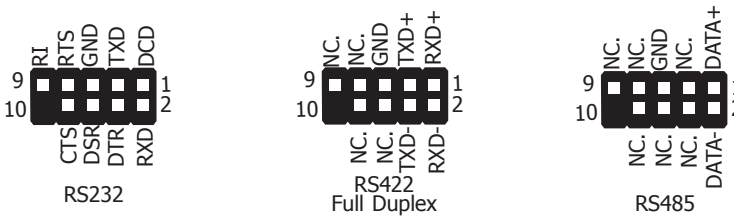

Serial Port Power Select

WM342-KD330

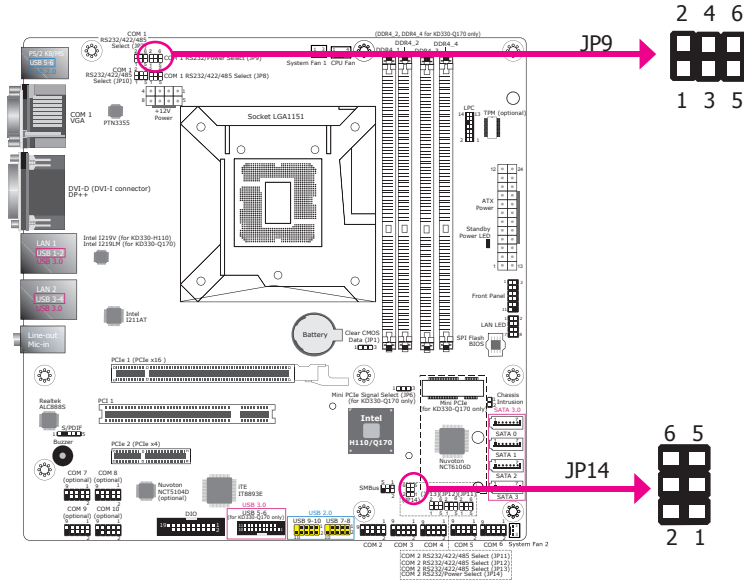

JP9 (for COM1) and JP14 (for COM2) are used to switch the COM ports to RS232 or RS232 with power. The pin assignments of the COM ports will vary according to the jumper settings.

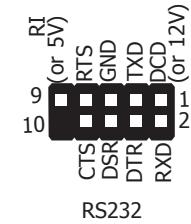
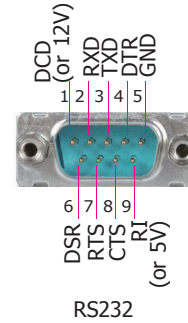

JP9 (COM 1)



1-3 (RI), 2-4 (DCD) On:
RS232 (default)



3-5 (+5V), 4-6 (+12V) On:
RS232 with power

JP14 (COM 2)



1-3 (RI), 2-4 (DCD) On:
RS232 (default)



3-5 (+5V), 4-6 (+12V) On:
RS232 with power

RS232/Power Select	JP9 (COM 1) JP14 (COM 2)
RS232 (default)	1-3 (RI), 2-4 (DCD) On
RS232 with power	3-5 (+5V), 4-6 (+12V) On

WM342-KD331

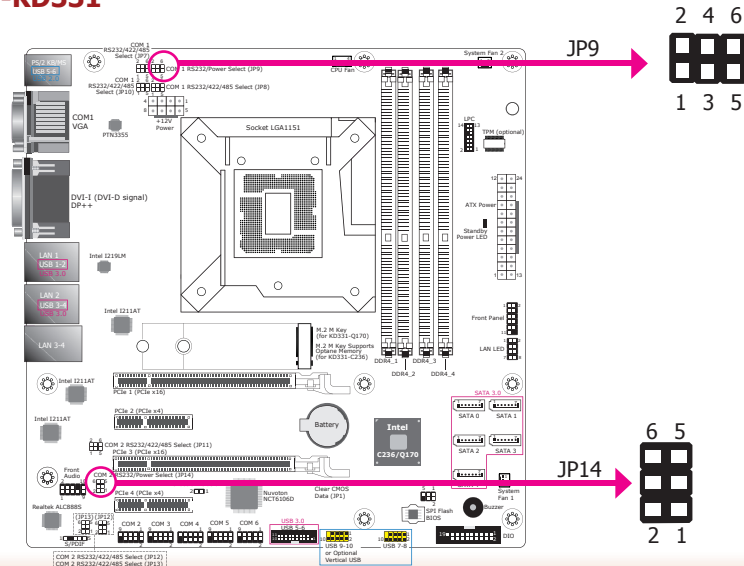

Mini PCIe/mSATA Signal Select (for KD330-Q170 only)

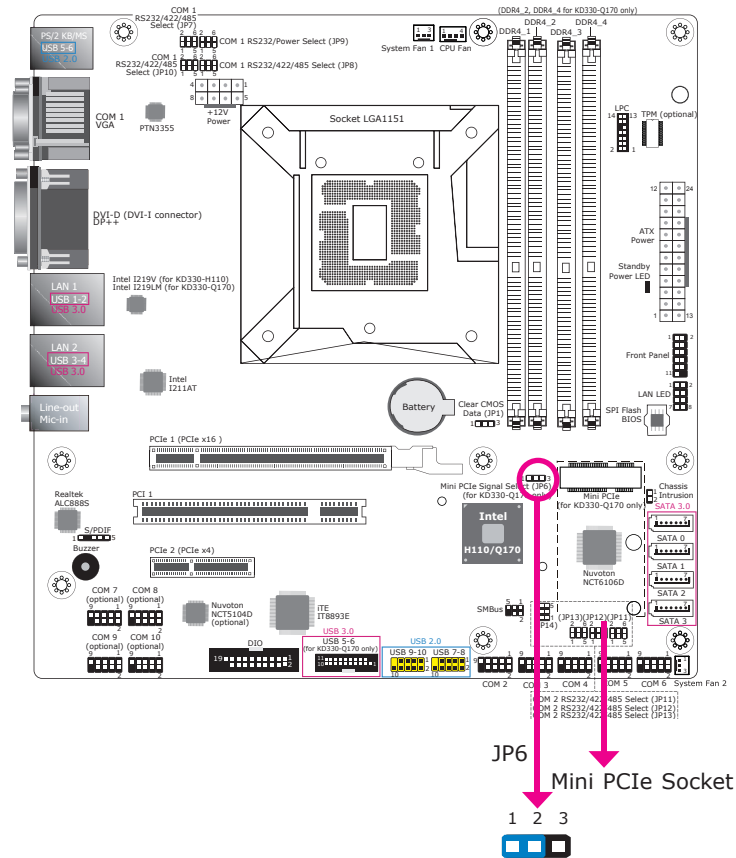

JP6 is used to select the signal for the Mini PCIe socket.

Mini PCIe/mSATA Signal Select	JP6
Mini PCIe (default)	1-2 On
mSATA	2-3 On

Chapter 5 - Ports and Connectors

Rear Panel I/O Ports

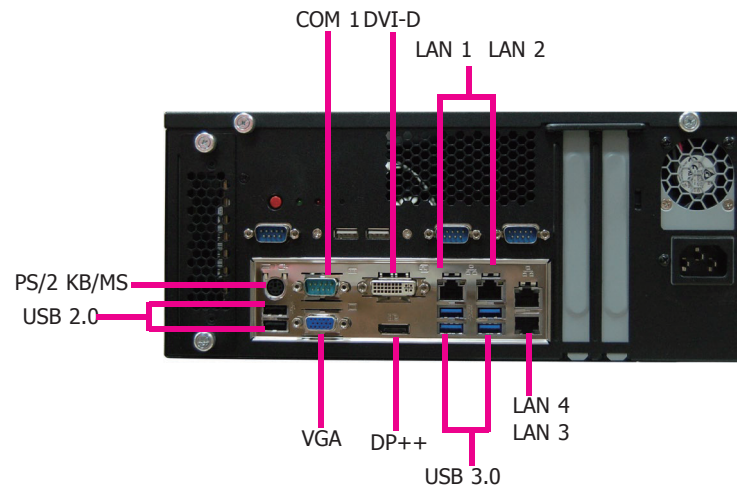

The rear panel I/O consists of the following ports:

- One PS/2 Keyboard/Mouse port
- One Serial port
- One VGA
- One DVI-D (DVI-I connector) port
- One DisplayPort
- Two RJ45 LAN ports (for WM342-KD330) or four RJ45 LAN ports (for WM342-KD331)
- Four USB 3.0 ports
- Two USB 2.0 ports
- Line-out and microphone jack and (for WM342-KD330 only)

PS/2 Keyboard/Mouse Port

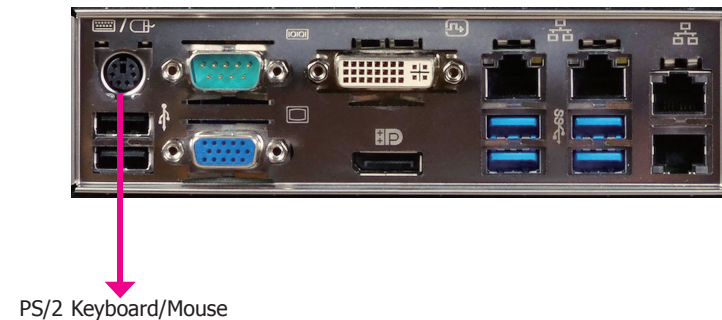

These ports are used to connect a PS/2 mouse/keyboard.

Wake-On PS/2 Keyboard/Mouse

The Wake-On-PS/2 Keyboard/Mouse function allows you to use the PS/2 keyboard or PS/2 mouse to power on the system. To use this function, configure the wake-on function of PS/2 keyboard/mouse in the Advanced menu ("ACPI Configuration" submenu) of the BIOS. Refer to Chapter 7 for more information.



Note:

This port cannot work with a PS/2 mouse alone. To connect both keyboard and mouse, please use a PS/2 keyboard mouse splitter cable adapter.

COM (Serial) Ports



COM 1 port

The pin functions of COM 1 will vary according to the respective jumper settings (JP7, JP8 and JP10). Another jumper (JP9) is used to configure COM 1 to pure RS232 or RS232 with power. Refer to "Serial Port RS232/422/485 Select" and "Serial Port Power Select" in Chapter 4 for more information.

In addition to the external COM port, the system board is equipped with onboard serial port pin headers. Refer to "I/O Connectors" in this chapter for more information.

The serial ports are asynchronous communication ports with 16C550A-compatible UARTs that can be used with modems, serial printers, remote display terminals, and other serial devices.

BIOS Setting

Configure the serial ports in the Advanced menu ("SIO NUVOTON6106D" submenu) of the BIOS. Refer to Chapter 7 for more information.

Graphics Interfaces

The display ports consist of the following:

- DVI-D (DVI-I connector)
- 1 DP++ port
- 1 VGA port

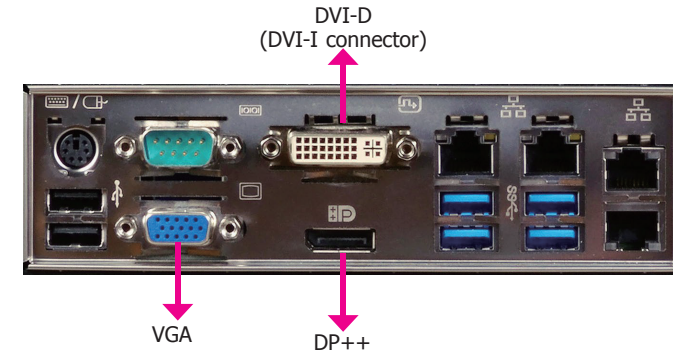

VGA Port

The VGA port is used for connecting a VGA monitor. Connect the monitor's 15-pin D-shell cable connector to the VGA port. After you plug the monitor's cable connector into the VGA port, gently tighten the cable screws to hold the connector in place.

DVI-D Port (DVI-I connector)

The DVI-D (DVI-I connector) port is used to connect an LCD monitor. Having a DVI-I connector, this port supports DVI-D signal only. Connect the display device's cable connector to the DVI-I port. After plugging the cable connector into the port, gently tighten the cable screws to hold the connector in place.

DP++ Port

The DisplayPort is a digital display interface used to connect a display device. The interface, developed by VESA and backwards compatible with VGA, DVI and HDMI, delivers higher performance than any other digital interfaces.

BIOS Setting

Configure display devices in the advanced menu ("Video Configuration" submenu) of the BIOS. Refer to Chapter 7 for more information.

RJ45 LAN Ports

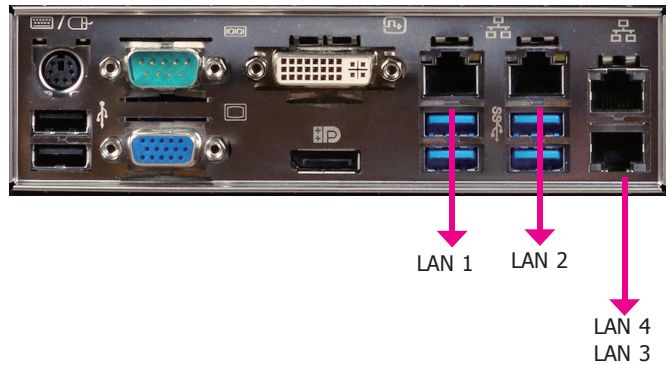

Features

- LAN 1: Intel® I219LM Gigabit Ethernet controller with iAMT11.0. (Note that Intel® Core™ i3, Celeron® and Pentium® processors and H110 chipset do not support iAMT.)
or
- LAN 1: Intel® I219V for WM342-KD330 (with the H110 chipset)
- LAN 2: Intel® I211AT PCI Express Gigabit Ethernet controller
- LAN 3, LAN4: Intel® I211AT PCI Express Gigabit Ethernet controller for WM342-KD331 (KD331-C236 and KD331-Q170) only

The LAN ports allow the system board to connect to a local area network with a network hub.

BIOS Setting

Configure the onboard LAN ports in the Advanced menu ("ACPI Configuration" submenu) of the BIOS. Refer to Chapter 7 for more information.

Driver Installation

Install the LAN drivers. Refer to Chapter 8 for more information.

USB Ports

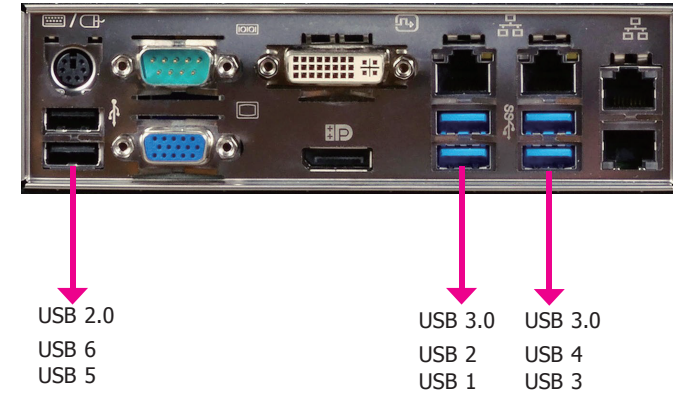

USB allows data exchange between your computer and a wide range of simultaneously accessible external Plug and Play peripherals.

In addition to these external USB ports, the system board is equipped with onboard USB 3.0 and 2.0 pin headers. Refer to "I/O Connectors" in this chapter for more information.

BIOS Setting

Configure these onboard USB devices in the Advanced menu ("USB Configuration" submenu) of the BIOS. Refer to Chapter 7 for more information.

Driver Installation

You may need to install the proper drivers in your operating system to use USB devices. Refer to Chapter 8 and your operating system's manual or documentation for more information.

Audio



Line-out
Mic-in

Rear Audio (for WM342-KD330 only)

The WM342-KD330 is equipped with 2 audio jacks:

- Line-out Jack (lime)
This jack is used to connect a headphone or external speakers.
- Mic-in Jack (pink)
This jack is used to connect an external microphone.

The WM342-KD331 is equipped with an internal audio connector instead.

Driver Installation

Install the audio driver. Refer to Chapter 8 for more information.

I/O Connectors

Front Audio Connector (for WM342-KD331 only)

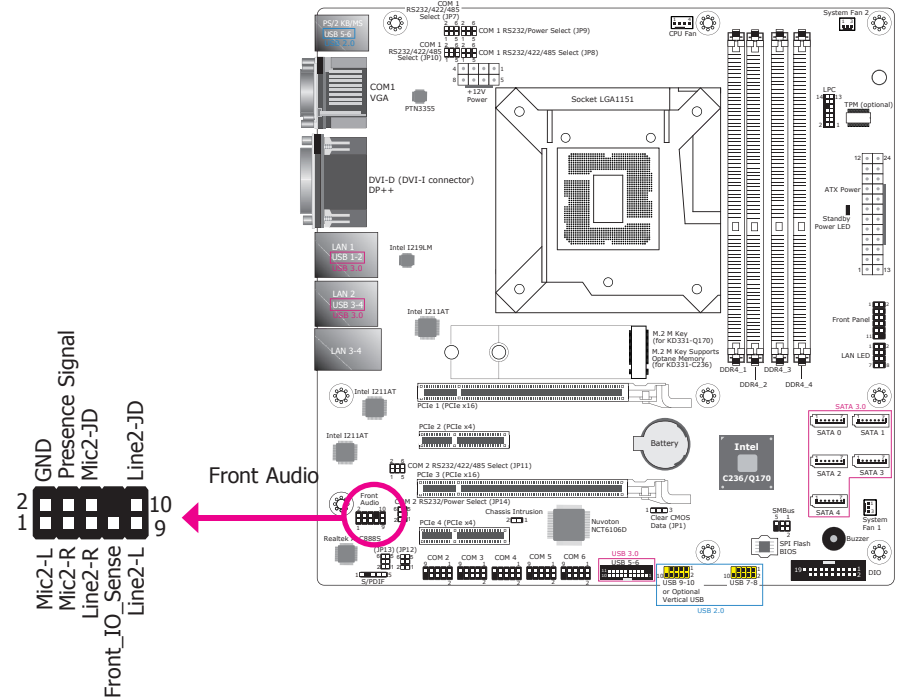

Front Audio

The front audio connector allows you to connect the line-out and mic-in jacks for audio output.

Driver Installation

Install the audio driver. Refer to the chapter 8 for more information.

S/PDIF Connector

KD330-Q170/H110

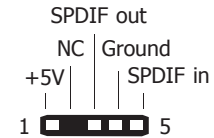
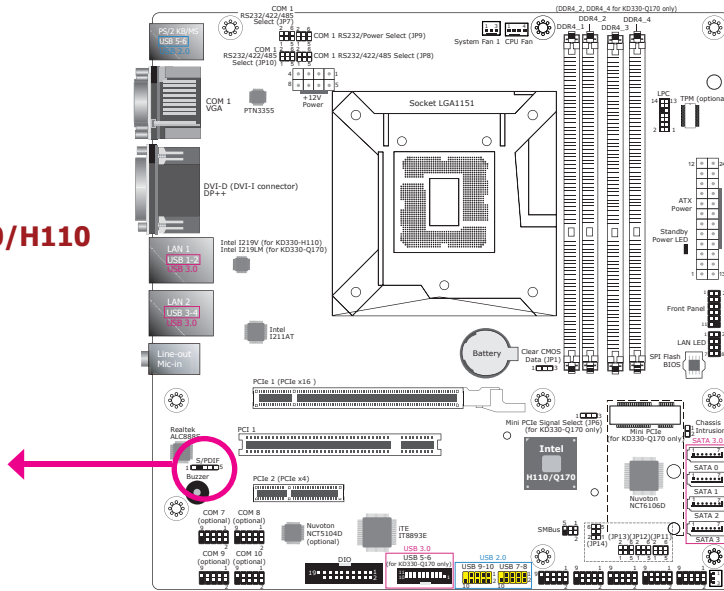

KD331-C236/Q170

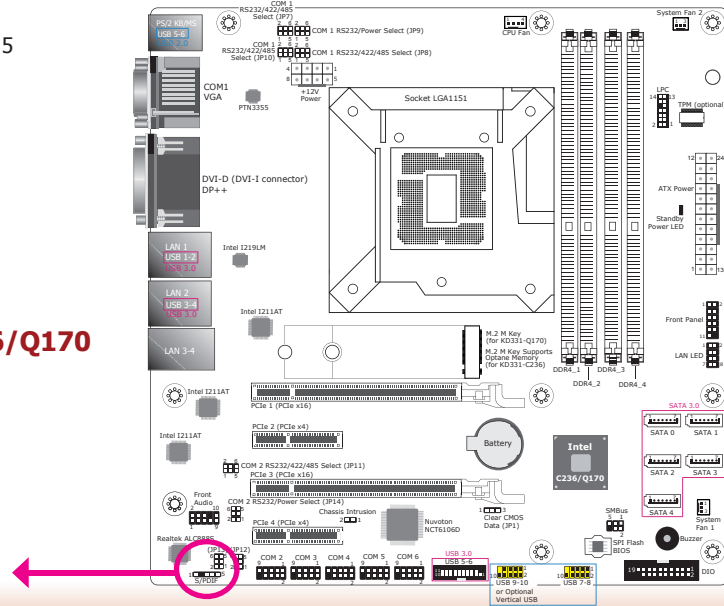

The S/PDIF connector is used to connect an external S/PDIF port. Your S/PDIF port may be mounted on a card-edge bracket. Install the card-edge bracket to an available slot at the rear of the system chassis and connect the audio cable to the S/PDIF connector. Make sure pin 1 of the audio cable is aligned with pin 1 of the S/PDIF connector.

Digital I/O and Power Connector

KD330-Q170/H110

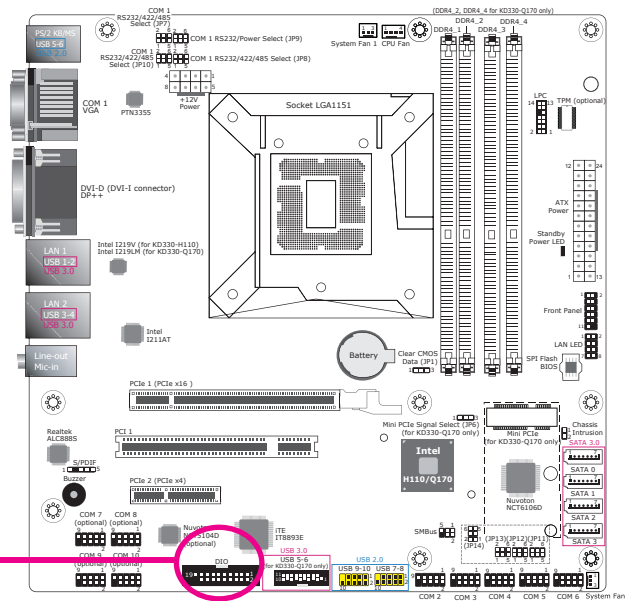

KD331-C236/Q170

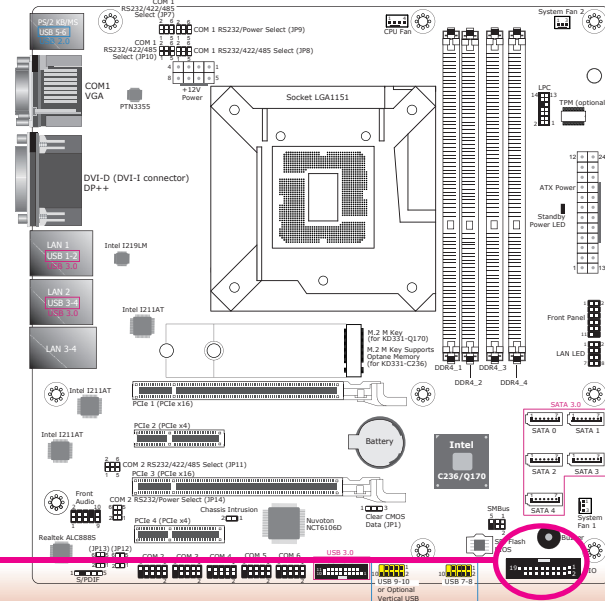

The Digital I/O connector provides monitoring and control function to the connected devices. We have built support software called EAPI that enables the functionality of hardware components. Please contact our technical support or sales representatives for the support software package.

Digital I/O Connector

Pins	Pin Assignment	Pins	Pin Assignment
1	GND	2	+12V
3	DIO7	4	+12V
5	DIO6	6	GND
7	DIO5	8	+5V
9	DIO4	10	+5V
11	DIO3	12	GND
13	DIO2	14	V_5P0_STBY
15	DIO1	16	V_5P0_STBY
17	DIO0	18	GND
19	GND	20	NC

SATA (Serial ATA) Connectors

KD330-Q170/H110

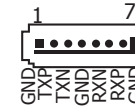
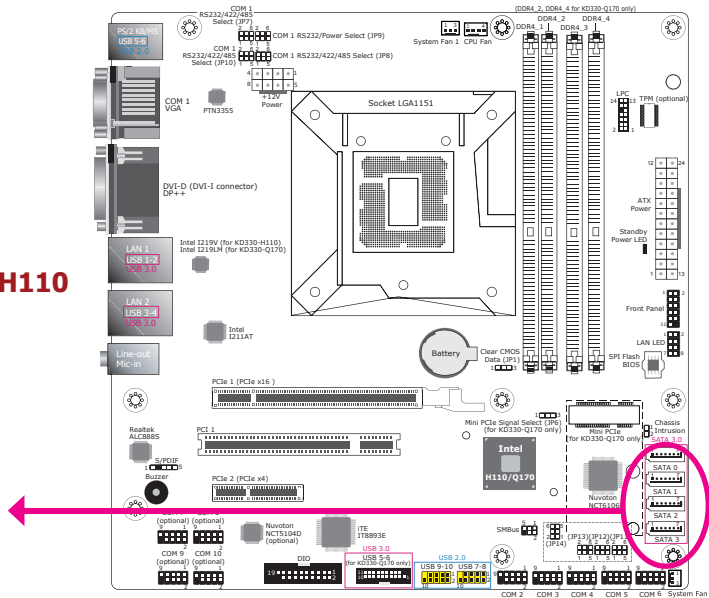

Features

KD330-Q170/H110:

- 4 Serial ATA ports
-Support SATA 3.0 with data transfer rate up to 6Gb/s
- Support Integrated Advanced Host Controller Interface (AHCI) controller with Intel® Rapid Storage Technology (RAID mode is only available for KD330-Q170)

KD331-C236/Q170:

- 5 Serial ATA ports
-Support SATA 3.0 with data transfer rate up to 6Gb/s
- Support Integrated Advanced Host Controller Interface (AHCI) controller with Intel® Rapid Storage Technology

The Intel® Rapid Storage Technology supports RAID configuration of 0, 1, 5 and 10, and with the Intel® C236 chipset, Intel® Optane™ Technology can be further supported. Please refer to "Expansion Slots" in this chapter for more information.

The Serial ATA connectors are used to connect Serial ATA devices. Connect one end of the SATA cable to one of the SATA connectors and the other end to your SATA device.

BIOS Setting

Configure the Serial ATA drives in the Advanced menu ("SATA Configuration" submenu) of the BIOS. Refer to Chapter 7 for more information.

KD331-C236/Q170

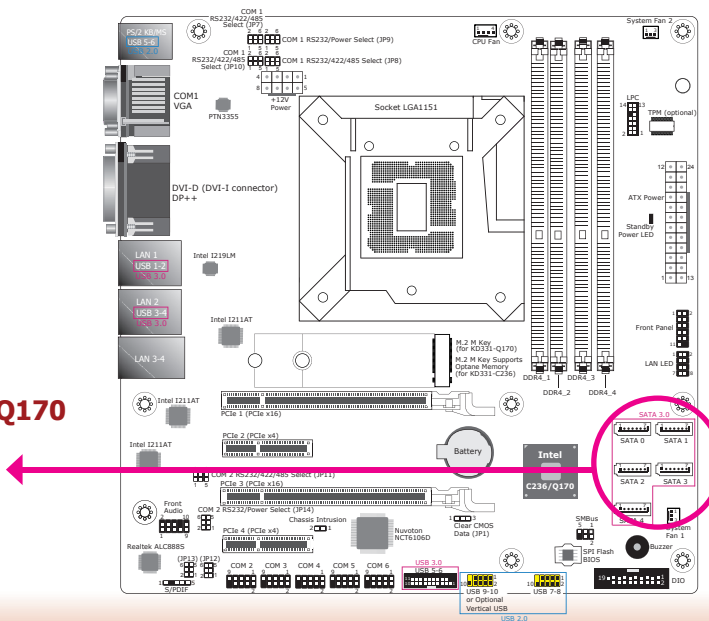

COM (Serial) Ports

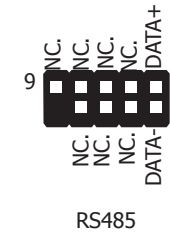
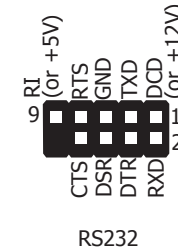
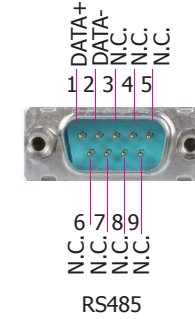
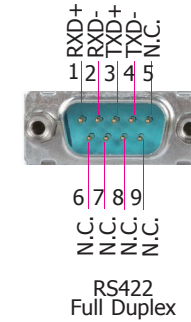
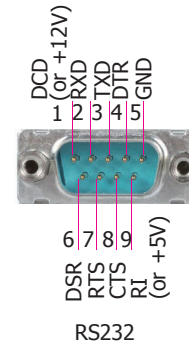
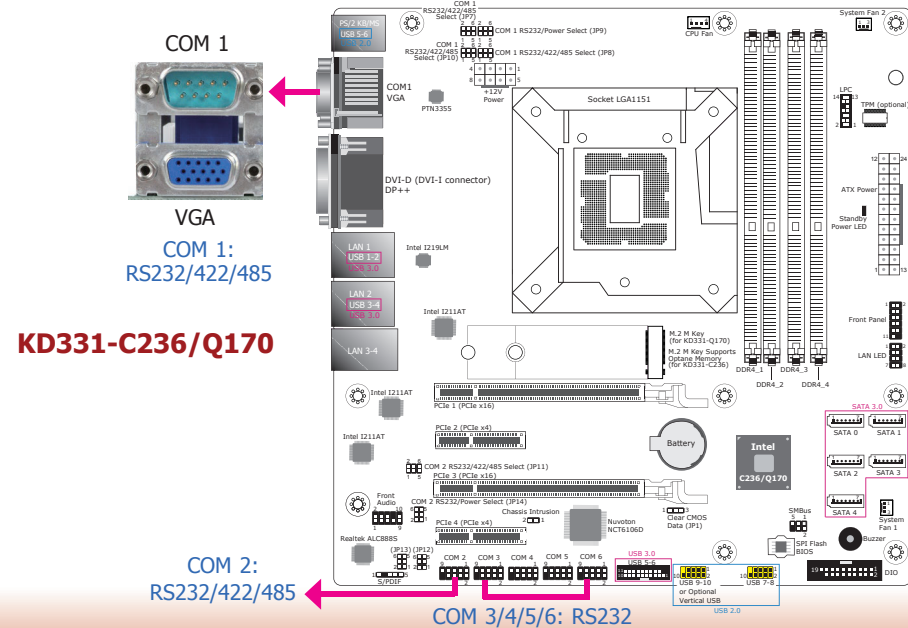
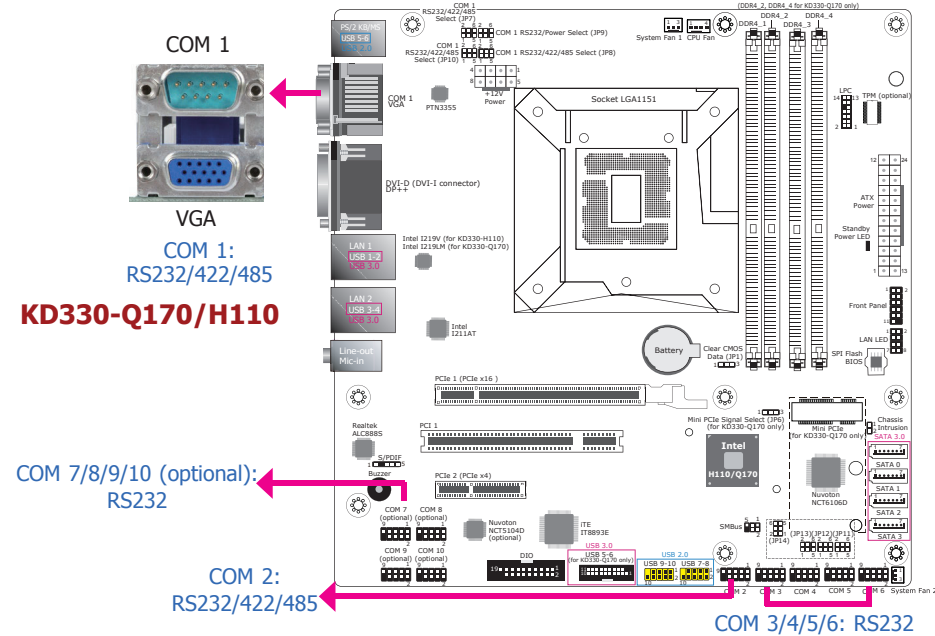

COM 1 port

Please refer to the "Rear Panel I/O Ports" section in this chapter for more information.

COM 2 port

The pin assignments of COM 1 will vary according to jumper settings (JP7, JP8, and JP10); the pin assignments of COM 2 will vary according to the jumper settings (JP11, JP12, and JP13). In addition, JP9 (for COM 1) and JP14 (for COM 2) are used to configure these ports to pure RS232 or RS232 with power. Refer to "Serial Port RS232/422/485 Select" and "Serial Port Power Select" in Chapter 4 for more information.

COM 3 to COM 6 (and the optional COM 7 to 10) are fixed at RS232.

The serial ports are asynchronous communication ports with 16C550A-compatible UARTs that can be used with modems, serial printers, remote display terminals, and other serial devices.

Connecting External Serial Ports

Your COM port may come mounted on a card-edge bracket. Install the card-edge bracket to an available slot at the rear of the system chassis then insert the serial port cable to the COM connector. Make sure the colored stripe on the ribbon cable aligns with pin 1 of the COM connector.

BIOS Setting

Configure the serial ports with more advanced options such as the RS485 auto flow mechanism in the Advanced menu ("Super I/O" submenu) of the BIOS. Refer to Chapter 7 for more information.

USB Ports KD330-Q170/H110

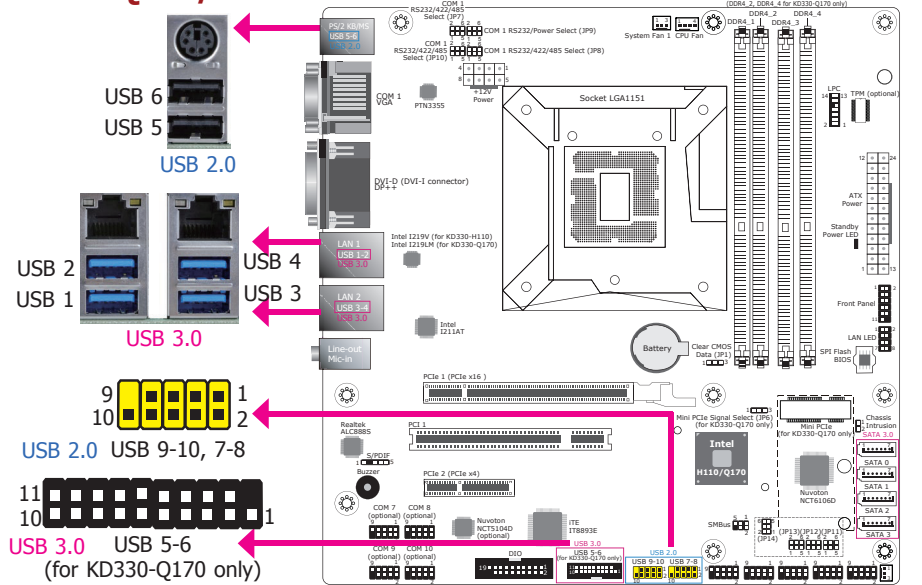

KD331-C236/Q170

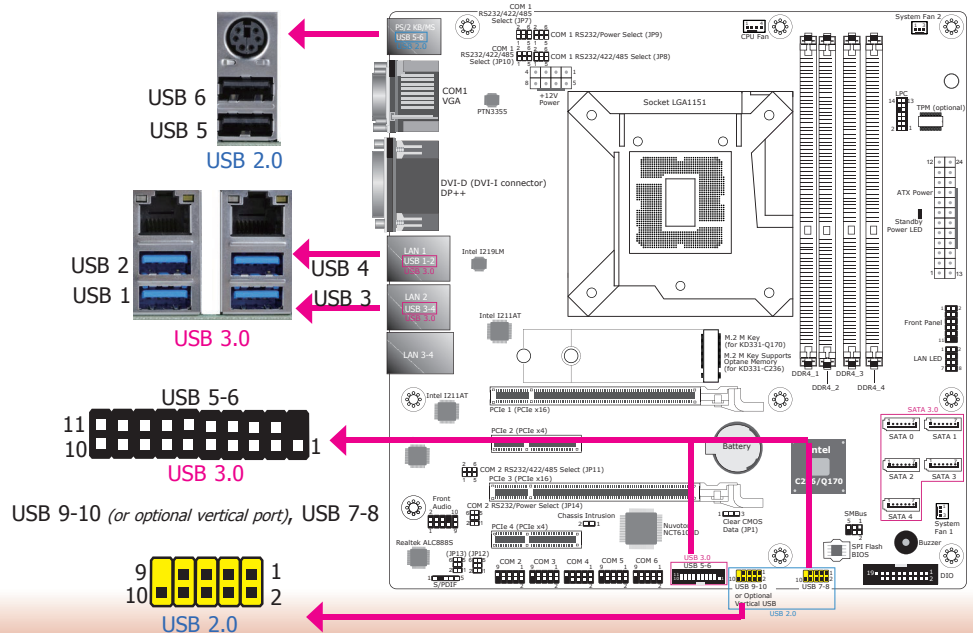

USB 3.0

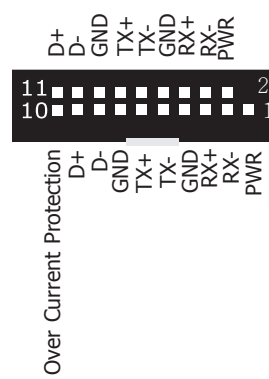

Optional USB 2.0 vertical port (for KD331-C236/Q170)

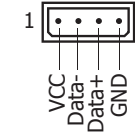

USB 2.0



KD330-Q170/H110:

- H110: 4 USB 3.0 (all external ports) and 6 USB 2.0 (2 external ports and 4 via internal pin headers)
- Q170: 6 USB 3.0 (4 external ports and 2 via internal pin headers) and 6 USB 2.0 (2 external ports and 4 via internal pin headers)

KD331-C236/Q170:

- C236/Q170: 8 USB 3.0 (4 external ports and 4 via internal pin headers) and 6 (or 5) USB 2.0 (2 external ports and 4 via internal pin headers or 2 via internal pin headers plus 1 vertical port)

The USB device allows data exchange between your computer and a wide range of simultaneously accessible external Plug and Play peripherals.

The system board is also equipped with internal USB 2.0 and USB 3.0 ports via pin headers. The 10-pin connector (USB 2.0) allows you to connect 2 additional ports. And the 20-pin connector (USB 3.0) allows you to connect 2 additional ports. These additional USB ports may be mounted on a card-edge bracket.

BIOS Setting

Configure these onboard USB devices in the Advanced menu ("USB Configuration" submenu) of the BIOS. Refer to Chapter 7 for more information.

Driver Installation

You may need to install proper drivers in your OS to use USB devices. Refer to Chapter 8 and your operating system's documentation for more information.

Cooling Fan Connectors KD330-Q170/H110

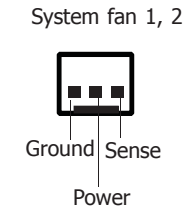
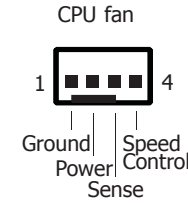
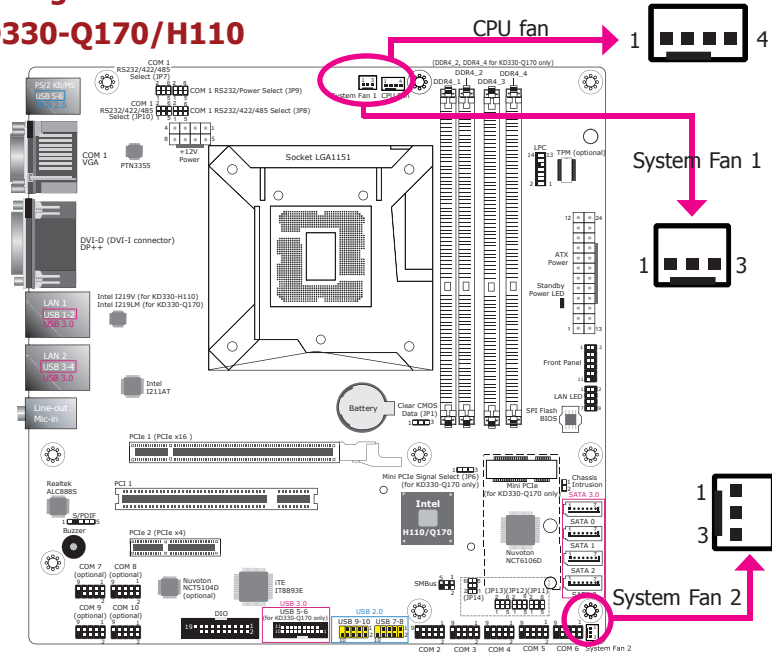

KD331-C236/Q170

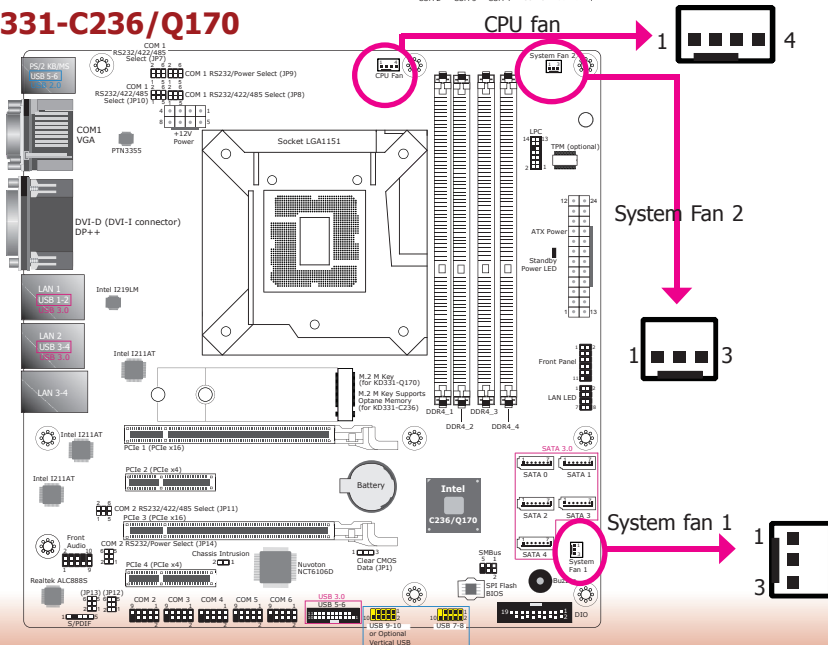

The fan connectors are used to connect cooling fans. The cooling fans will provide adequate airflow throughout the chassis to prevent overheating the CPU and system board components.

BIOS Setting

The Advanced menu ("PC Health Status" submenu) of the BIOS displays the current speed of the cooling fans. Refer to Chapter 7 for more information.

Chassis Intrusion Connector

KD330-Q170/H110

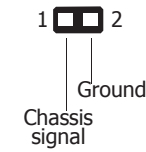
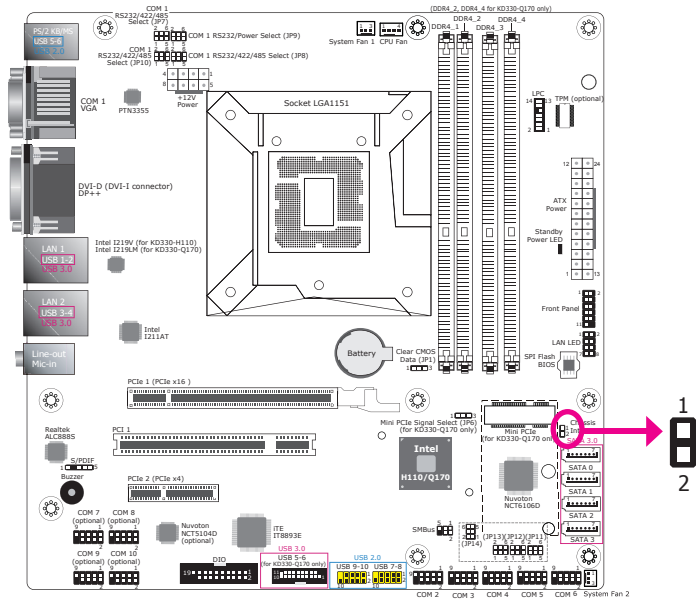

KD331-C236/Q170

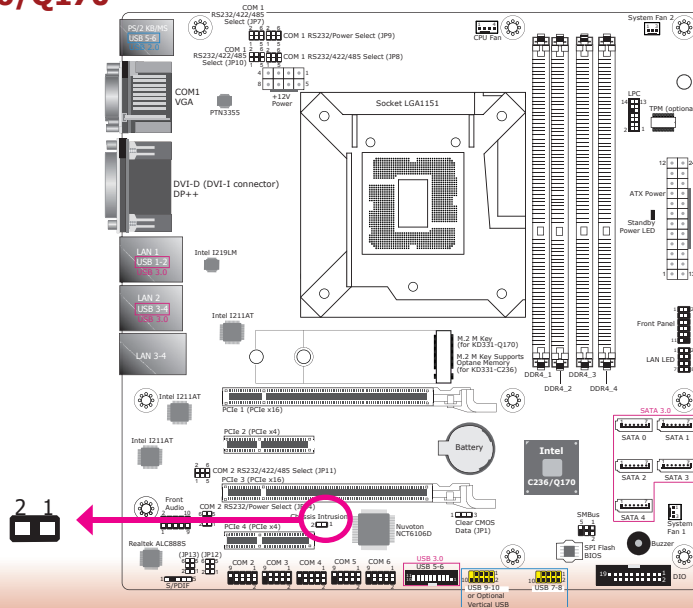

The board supports the chassis intrusion detection function. Connect the chassis intrusion sensor cable from the chassis to this connector. When the system's power is on and a chassis intrusion occurs, an alarm will sound. When the system's power is off and a chassis intrusion occurs, the alarm will sound only when the system restarts.

LPC Connector KD330-Q170/H110

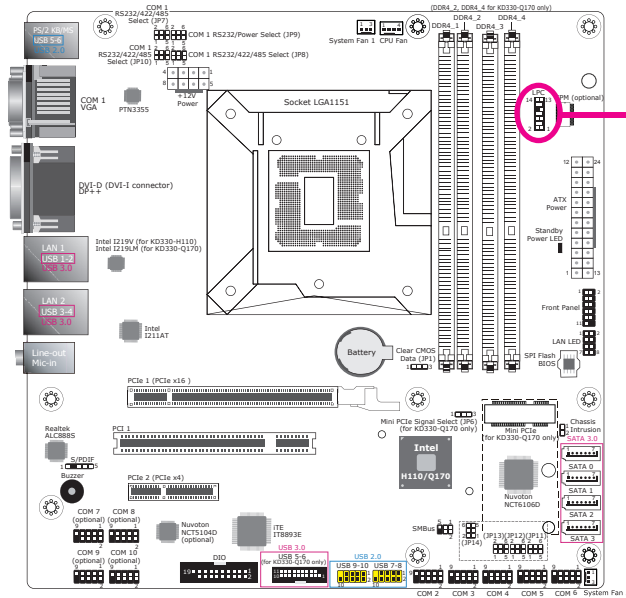

KD331-C236/Q170

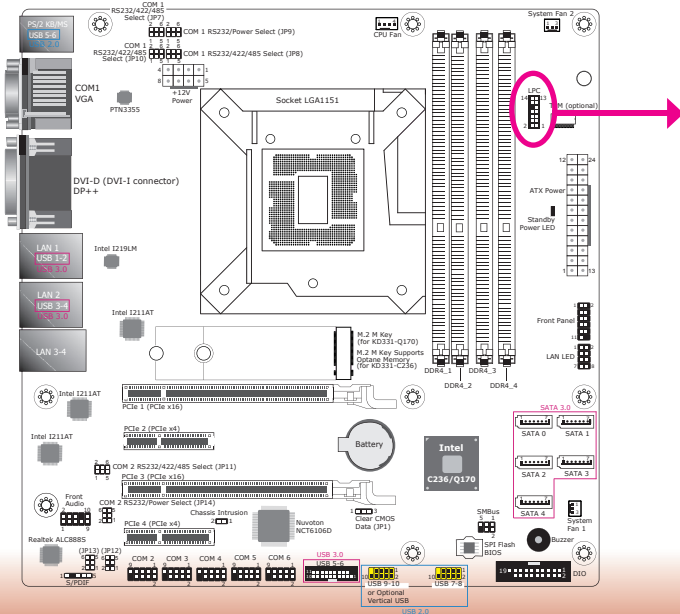

The Low Pin Count Interface was defined by Intel® Corporation to facilitate the industry's transition towards legacy free systems. It allows the integration of low-bandwidth legacy I/O components within the system, which are typically provided by a Super I/O controller. Furthermore, it can be used to interface firmware hubs, Trusted Platform Module (TPM) devices and embedded controllers. Data transfer on the LPC bus is implemented over a 4 bit serialized data interface, which uses a 24MHz LPC bus clock. For more information about LPC bus, please refer to the Intel® Low Pin Count Interface Specification Revision 1.1'. The table below indicates the pin assignments of the LPC connector.

Pin	Pin Assignment	Pin	Pin Assignment
1	L_CLK	2	L_AD1
3	L_RST#	4	L_AD0
5	L_FRAME#	6	3V3
7	L_AD3	8	GND
9	L_AD2	10	----
11	INT_SERIRQ	12	GND
13	5VSB	14	5V

Power Connectors KD330-Q170/H110

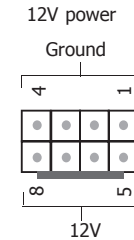
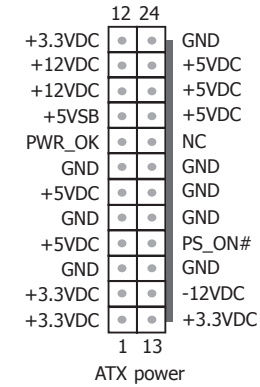
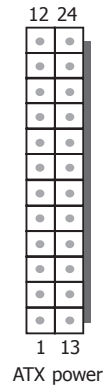
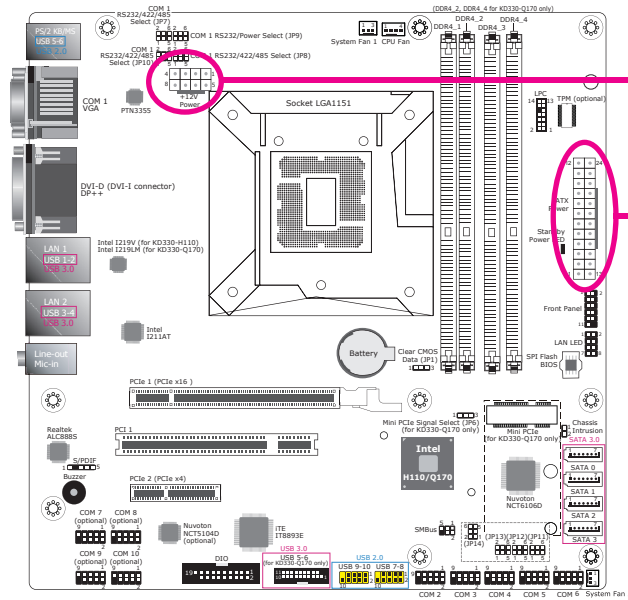

KD331-C236/Q170

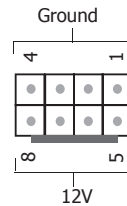
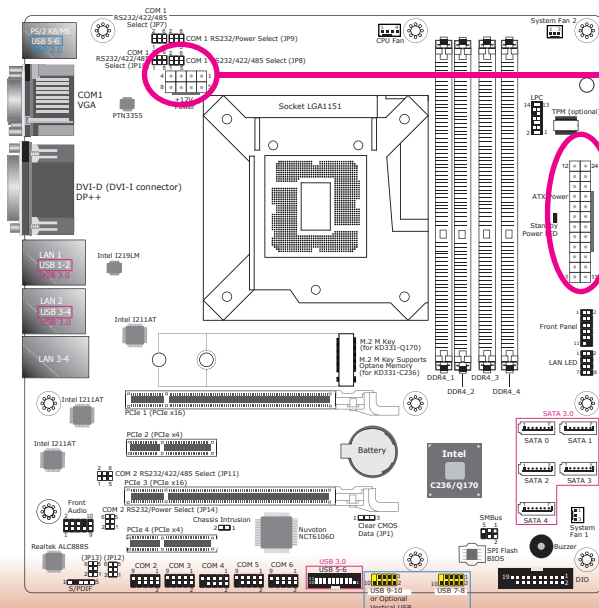

Use a power supply that complies with the ATX12V Power Supply Design Guide Version 1.1. An ATX12V power supply unit has a standard 24-pin ATX main power connector that must be inserted into the 24-pin connector. The 8-pin +12V power connector enables the delivery of more +12VDC current to the processor's Voltage Regulator Module (VRM).

The power connectors from the power supply unit are designed to fit the 24-pin and 8-pin connectors in only one orientation. Make sure to find the proper orientation before plugging the connectors.

Please use the recommended power supply unit with the correct wattage. Insufficient power supplied to the system may result in system instability or the add-in boards and peripherals not functioning properly. Calculating the system's approximate power usage is important to ensure that the power supply meets the system's consumption requirements.

SMBus Connector KD330-Q170/H110

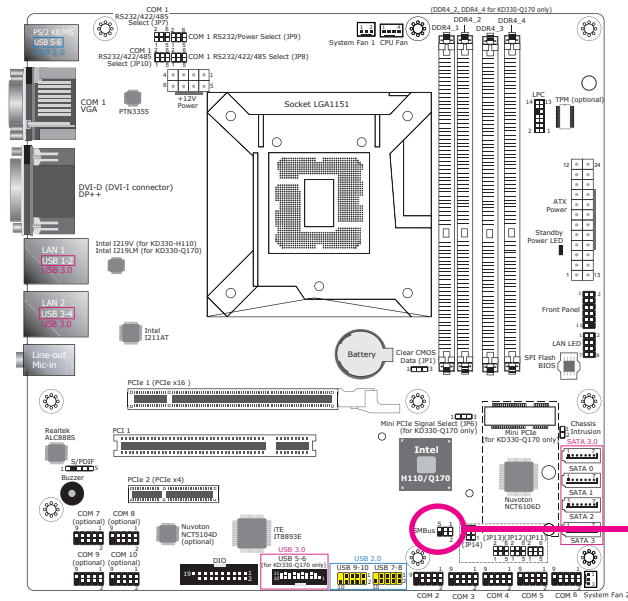

KD331-C236/Q170

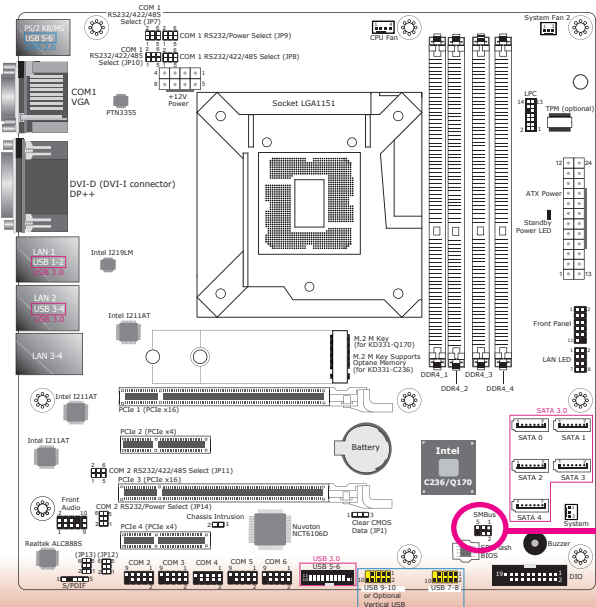

The SMBus (System Management Bus) connector is used to connect SMBus devices. It is a multiple device bus that allows multiple chips to connect to the same bus and enables each one to act as a master by initiating data transfer.

Front Panel Connector KD330-Q170/H110

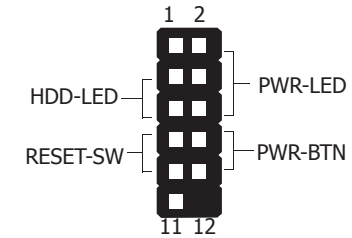
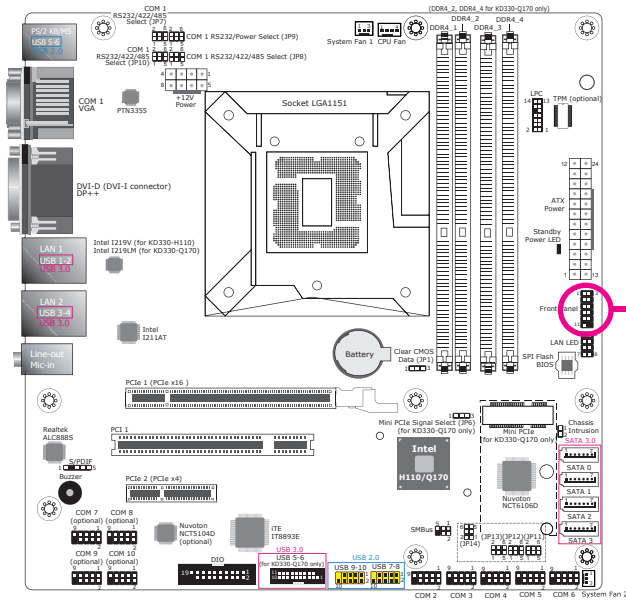

This connector provides several control and LED indicator functions.

HDD-LED - Hard Drive LED

This LED will be lit when the hard drive is being accessed.

RESET SW - Reset Switch

This switch allows you to reboot the system without having to power off the system.

PWR-BTN - Power Button

This switch is used to power on or off the system.

PWR-LED - Power/Standby LED

When the system's power is on, this LED will be lit. When the system is in the S1 (POS - Power On Suspend) state, it will blink every second. When the system is in the S3 (STR - Suspend To RAM) state, it will blink every 4 seconds.

KD331-C236/Q170

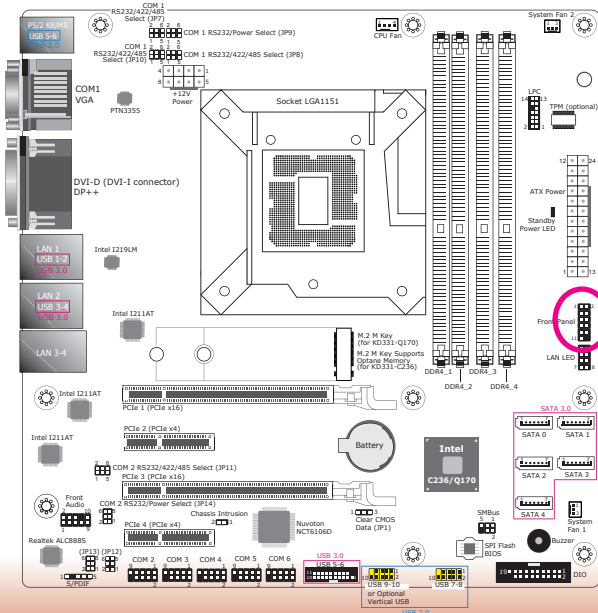

	Pin	Pin Assignment		Pin	Pin Assignment
HDD-LED	3	HDD Power	PWR-LED	2	LED Power
	5	Signal		4	LED Power
RESET SW	7	Ground	PWR-BTN	6	Signal
	9	RST Signal		8	Ground
	11	N.C.		10	Signal

Expansion Slots

KD330-Q170/H110

Q170 H110

- PCIe x16 (Gen 3) PCIe x16 (Gen 3)
- PCI PCI
- PCIe x4 (Gen3) PCIe x4 (Gen2)
- Mini PCIe slot (for KD330-Q170 only)

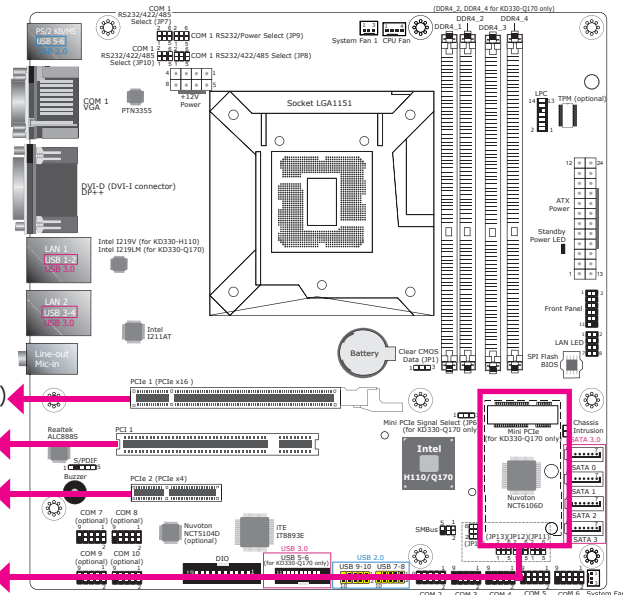

KD331-C236/Q170

C236 Q170

- PCIe x16 (x16 or x8 Gen3)
- PCIe x4 (Gen3)
- PCIe x8 (Gen3)
- PCIe x4 (Gen3)

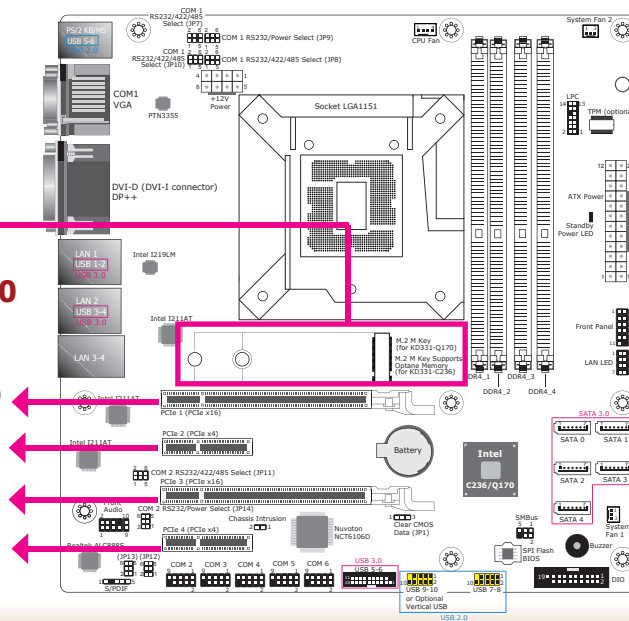

KD330-Q170/H110:

Mini PCIe Slot (only for KD330-Q170)

The KD330-Q170 board is equipped with a full-size Mini PCIe slot (PCIe/USB/SATA signals). This slot supports the installation of a Mini PCIe or an mSATA card. To switch the interface between Mini PCIe and mSATA, please refer to Jumper Settings in Chapter 4.

PCI Express x16 Slot (Gen3 signal)

Install a PCI Express x16 (lanes) expansion card such as a graphics card into the PCIe x16 (lanes) slot. To install a graphics card into this slot, align the graphics card above the slot then press it down firmly until it is completely seated in the slot. The retaining lever on the end of the slot will automatically hold the graphics card in place.

PCI Slots

These PCI slots support PCI expansion cards.

PCI Express x4 Slot: internal without access from external chassis slot

Install PCI Express cards such as network cards or other expansion cards. Note that the KD330-Q170 board supports PCIe Gen3 x4 (lanes) whereas the KD330-H110 board supports PCIe Gen2 x4 (lanes).

KD331-C236/Q170:

The M.2 slot supports both M.2 Type 2260 and 2280 (Key B) form factors. In WM342-KD331 with the Intel® C236 chipset, it further supports the Intel® Optane™ memory module.

PCI Express x16 (x16 or x8 Gen3 signal) Slot

Install a PCI Express x16 (lanes) expansion card such as a graphics card into this slot. It shares the signal with the below PCIe x8 slot. To install a graphics card into this slot, align the graphics card above the slot then press it down firmly until it is completely seated in the slot. The retaining lever on the end of the slot will automatically hold the graphics card in place.

PCI Express x8 (Gen3 signal) Slot: internal without access from external chassis slot

The second PCIe x8 slot shares the signal with the above PCIe x16 slot. The PCIe x16 automatically switches to x8 signal when this slot is occupied.

PCI Express x4 (Gen3 signal) Slots

Install PCI Express expansion cards to expand the I/O capability of the system.

Intel® Optane™ Configuration

To set up and enable Intel® Optane™ technology, please configure the SATA controller mode to "Intel RST Premium With Intel Optane System Acceleration" and install the Intel® Rapid Storage Technology driver (15.5 or later). Refer to Chapter 7 and 8 for more information.

BIOS Setting

Configure these PCIe slots including their speed in the Advanced menu ("PCI Express Configuration" submenu) of the BIOS. Refer to Chapter 7 for more information.

Standby Power LED

KD330-Q170/H110, KD331-C236/Q170

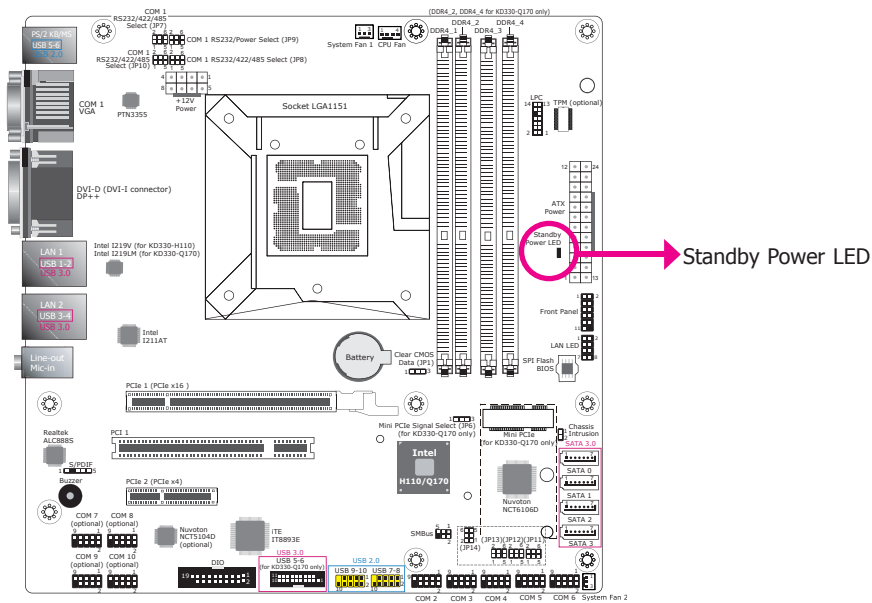

This LED will be red when the system is in the standby mode. It indicates that there is power on the system board. Power off the PC and then unplug the power cord prior to installing any devices. Failure to do so will cause severe damage to the motherboard and components.

Battery

KD330-Q170/H110, KD331-C236/Q170

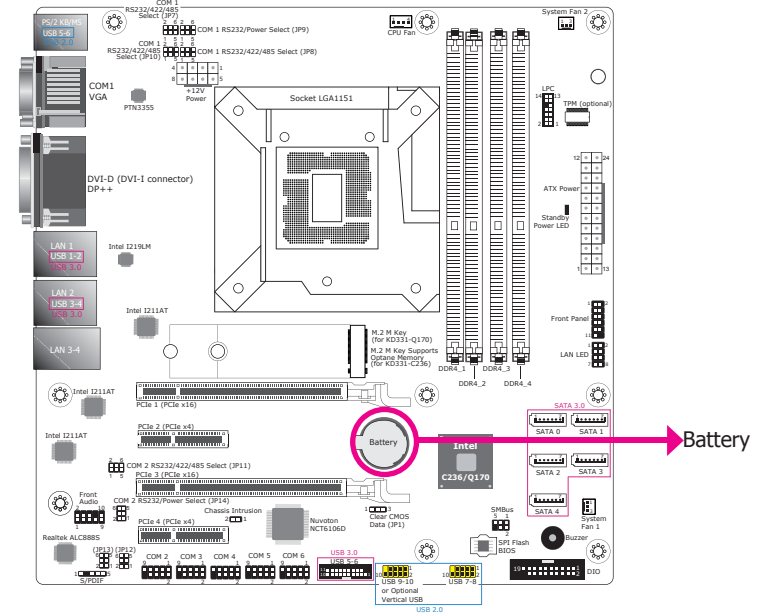

The lithium ion battery powers the real-time clock and CMOS memory. It is an auxiliary source of power when the main power is shut off.

Safety Measures

- Danger of explosion if battery incorrectly replaced.
- Replace only with the same or equivalent type recommend by the manufacturer.
- Dispose of used batteries according to local ordinance.

LAN LED

KD330-Q170/H110, KD331-C236/Q170

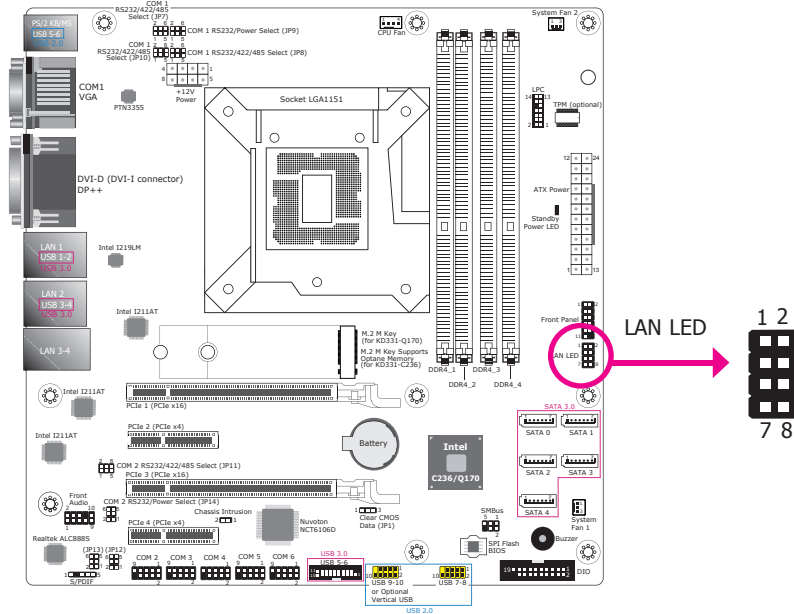

The LAN LED connector is used to detect the connection state of RJ45 LAN ports when the connection is made to an active network via a cable. The pin functions of the LAN LED connector are listed below.

Pin	Pin Assignment	Pin	Pin Assignment
1	GBE_LED_1000-	2	GBE_LED_100-
3	GBE_LED_LINK_ACT-	4	3V3DU
5	LINK_1000_2	6	LINK_100_2
7	LINK_ACTIVITY_2	8	3V3DU

Chapter 6 - Mounting Options



Note:

The system unit used in the following illustrations may not resemble the actual one. These illustrations are for reference only.

There are 2 mount brackets available:

- Wall mount



- Rack-mount tray bracket

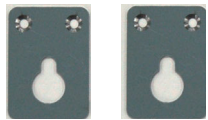

Wall Mount



Wall mount kit include:

- 2 wall mount brackets



1. On the bottom of the system, use 4 mounting screws to secure the wall mount brackets on each side of the system.



The mechanical drawing of the wall mount illustration with dimensions.

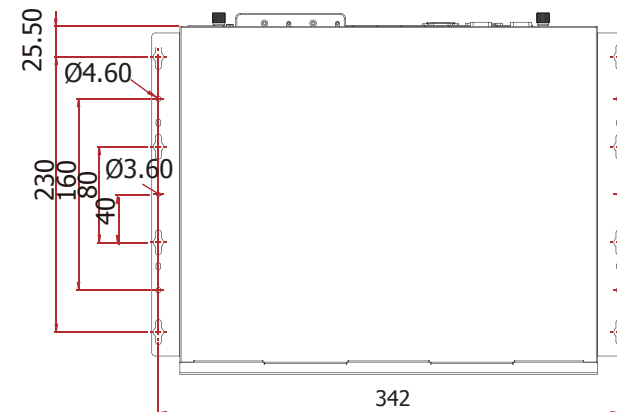
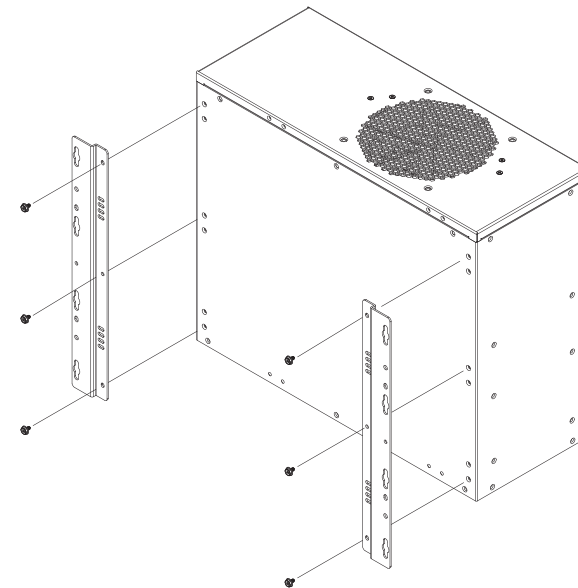

Rack Tray Mount

-  Rack-mount tray kit include:
- 2 Rack-mount tray brackets

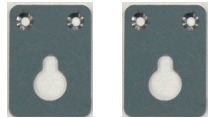

1. Place the system on the rack-mount tray and align the mounting holes of the tray with the mount bracket.
2. Follow the rack manufacture's instruction to properly secure the system to the rack.

Chapter 7 - BIOS Setup

Overview

The BIOS is a program that takes care of the basic level of communication between the CPU and peripherals. It contains codes for various advanced features found in this system board. The BIOS allows you to configure the system and save the configuration in a battery-backed CMOS so that the data retains even when the power is off. In general, the information stored in the CMOS RAM of the EEPROM will stay unchanged unless a configuration change has been made such as a hard drive replaced or a device added.

It is possible that the CMOS battery will fail causing CMOS data loss. If this happens, you need to install a new CMOS battery and reconfigure the BIOS settings.



Note:

The BIOS is constantly updated to improve the performance of the system board; therefore the BIOS screens in this chapter may not appear the same as the actual one. These screens are for reference purpose only.

Default Configuration

Most of the configuration settings are either predefined according to the Load Optimal Defaults settings which are stored in the BIOS or are automatically detected and configured without requiring any actions. There are a few settings that you may need to change depending on your system configuration.

Entering the BIOS Setup Utility

The BIOS Setup Utility can only be operated from the keyboard and all commands are keyboard commands. The commands are available at the right side of each setup screen.

The BIOS Setup Utility does not require an operating system to run. After you power up the system, the BIOS message appears on the screen and the memory count begins. After the memory test, the message "Press DEL to run setup" will appear on the screen. If the message disappears before you respond, restart the system or press the "Reset" button. You may also restart the system by pressing the <Ctrl> <Alt> and keys simultaneously.

Legends

Keys	Function
Right and Left arrows	Move the highlight left or right to select a menu
Up and Down arrows	Move the highlight up or down between submenu or fields
<Esc>	Exit the BIOS Setup Utility
<F1>	Help
<F5>	Change values
<F6>	Change values
<F9>	Setup Defaults
<F10>	Save and Exit
<Enter>	Press <Enter> to enter the highlighted submenu.

Scroll Bar

When a scroll bar appears to the right of the setup screen, it indicates that there are more available fields not shown on the screen. Use the up and down arrow keys to scroll through all the available fields.

Submenu

When "►" appears on the left of a particular field, it indicates that a submenu which contains additional options are available for that field. To display the submenu, move the highlight to that field and press <Enter>.

Insyde BIOS Setup Utility

Main

The Main menu is the first screen that you will see when you enter the BIOS Setup Utility.

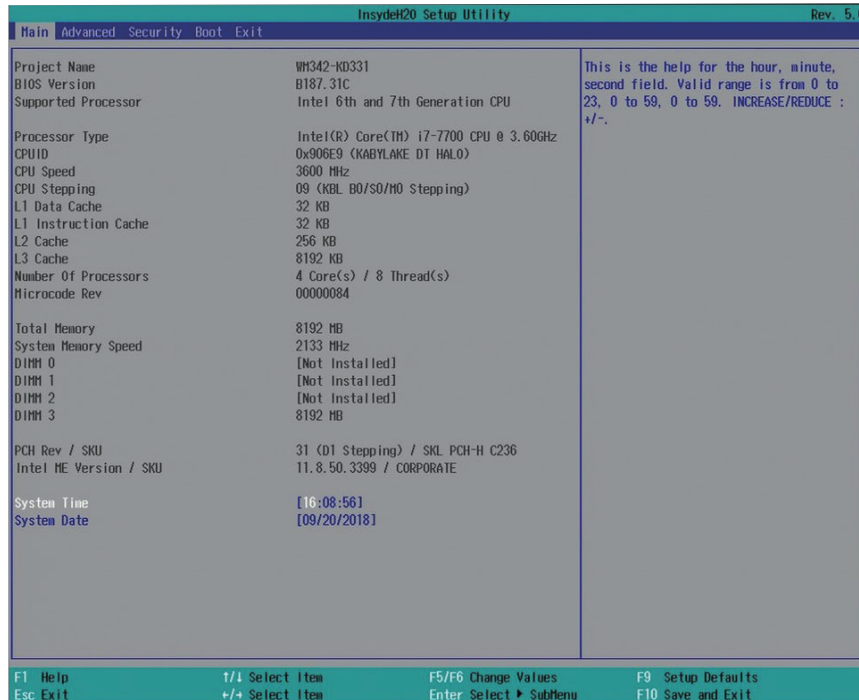

System Time

The time format is <hour>, <minute>, <second>. The time is based on the 24-hour military-time clock. For example, 1 p.m. is 13:00:00. Hour displays hours from 00 to 23. Minute displays minutes from 00 to 59. Second displays seconds from 00 to 59.

System Date

The date format is <month>, <date>, <year>. Month displays the month, from January to December. Date displays the date, from 1 to 31. Year displays the year, from 1980 to 2099.

Advanced

The Advanced menu allows you to configure your system for basic operation. Some entries are defaults required by the system board, while others, if enabled, will improve the performance of your system or let you set some features according to your preference.



Important:

Setting incorrect field values may cause the system to malfunction.

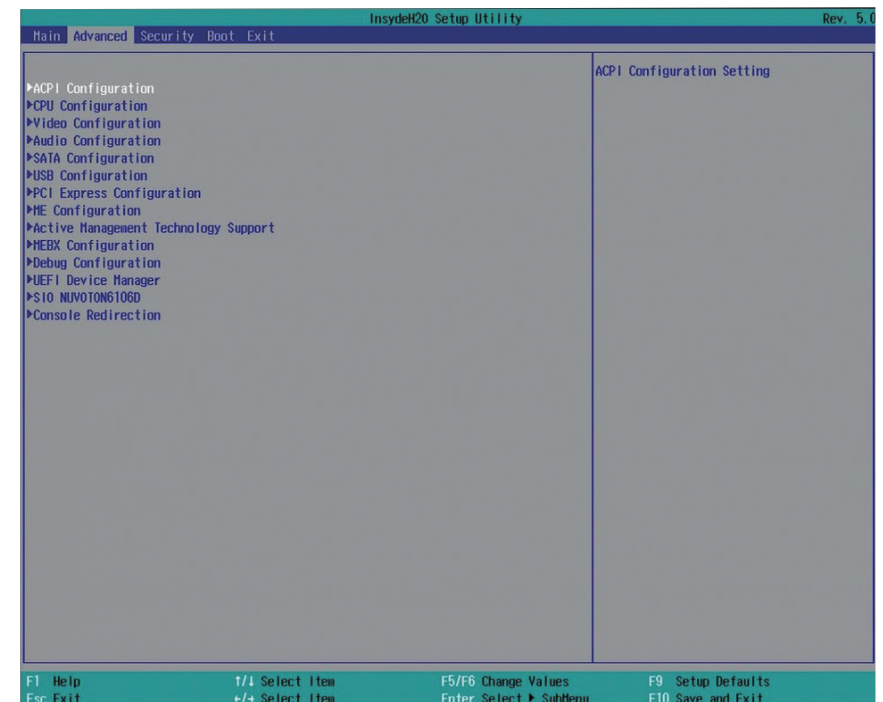

ACPI Settings

This section configures system's ACPI parameters.

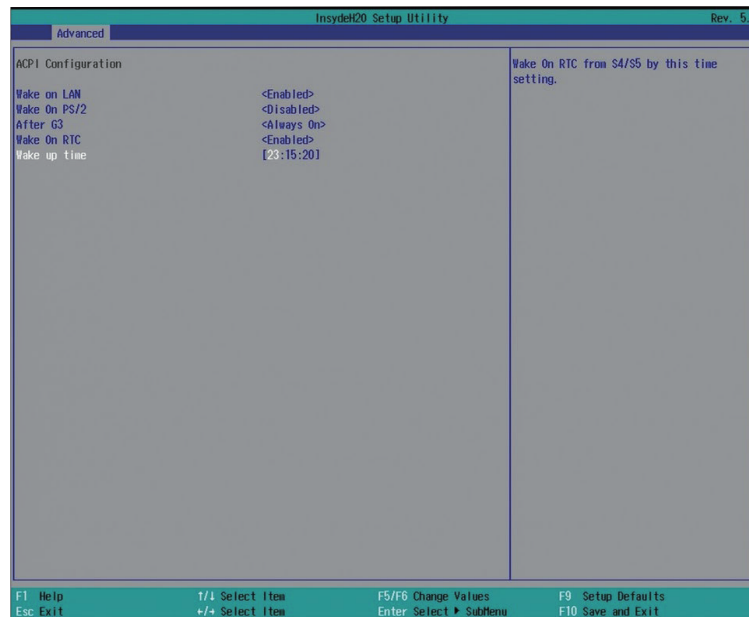

Wake on LAN

Enable or disable WOL (wake-on-LAN) to wake the system through an Ethernet adapter.

Wake on PS/2

Enable or disable the use of PS/2 devices to wake the system.

After G3

Specify which state the system should be in when power is re-applied after a power failure (G3, the mechanical-off, state).

Always On The system is powered on.

Always Off The system is powered off.

Wake on RTC/Wake up Time

Enable this function to automatically power the system up at a particular time every day from the real-time clock battery. Specify the wake up time of the day below: <hour>, <minute>, <second>. The default is disabled.

CPU Configuration

This section configures the CPU.

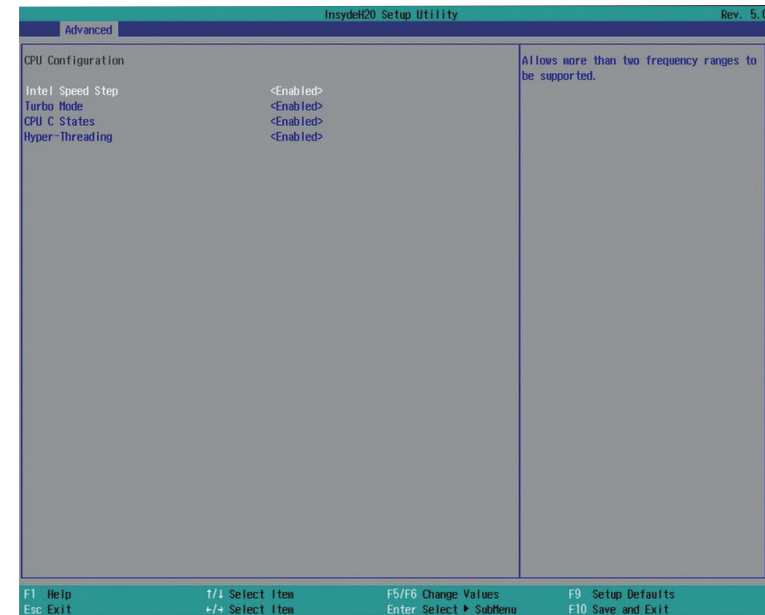

Intel® SpeedStep™

Enable or disable the Enhanced Intel SpeedStep® Technology, which helps optimize the balance between system's power consumption and performance. After it is enabled in the BIOS, you can take advantage of its offering by setting power schemes from the operating system's power options.

Turbo Mode

Enable or disable processor turbo mode, which allows the processor core to automatically run faster than the base frequency by taking advantage of thermal and power headroom.

CPU C States

Enable or disable CPU Power Management. It allows the CPU to go to C states when it's not 100% utilized.

Hyper-Threading

Enable Intel® Hyper-Threading Technology (HT) on the processor to improve performance of operating systems and software that are optimized for hyper-threading technology. Please check the software specifications to determine if enabling HT can be advantageous to the overall system performance.

Video Configuration

This section configures the video settings. Note that the configuration options vary depending on the "Boot type" selected in the "Boot" menu.

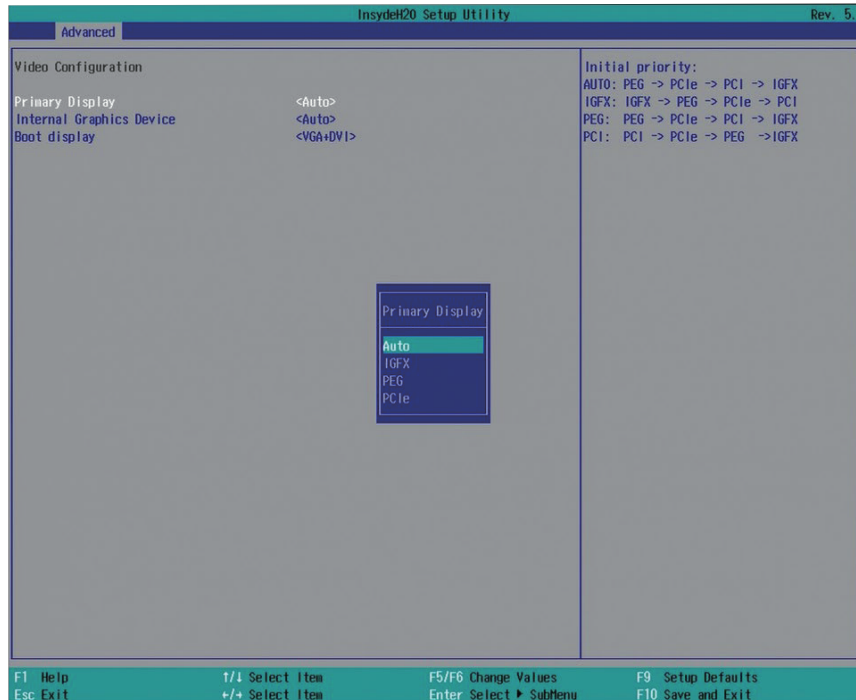

Primary Display

Select the primary display for the system. Note that this option will be shown only if the "Boot type" is set to "Dual" or "UEFI". Depending on your selection, the order of video device initialization will be as follows:

Auto mode: PEG (PCIe Graphics devices connected to PEG lanes directly routed from the CPU)->PCIe graphics devices->PCI graphics devices->IGFX (internal graphics)

IGFX: IGFX (internal graphics)->PEG (PCIe Graphics devices connected to PEG lanes directly routed from the CPU)->PCIe graphics devices->PCI graphics devices

PEG: PEG (PCIe Graphics devices connected to PEG lanes directly routed from the CPU) ->PCIe graphics devices->PCI graphics devices->IGFX (internal graphics)

PCIe: PCIe graphics devices->PEG (PCIe Graphics devices connected to PEG lanes directly routed from the CPU)->IGFX (internal graphics)->PCI graphics devices

Internal Graphics Device

Enable, disable or automatically detect the internal graphics.

Boot display

Prioritize device combination for display during system boot. Note that this option will be shown only if the "Boot type" is set to "Dual" or "Legacy".

The options are as follows:

DVI+DP1

DVI+VGA

DP1+DVI

DP1+VGA

VGA+DVI

VGA+DP1

Audio Configuration

This section configures the audio settings.

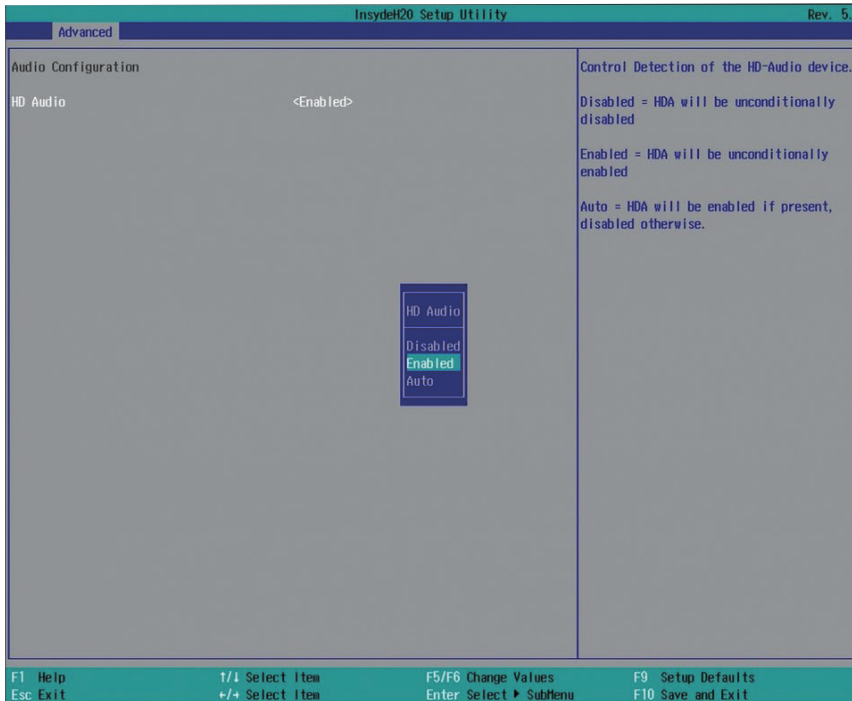

HD Audio

Control the detection of the high-definition audio devices.

Disabled

High-definition audio devices will be unconditionally disabled.

Enabled

High-definition audio devices will be unconditionally enabled.

Auto

High-definition audio devices will be enabled if present and disabled otherwise.

SATA Configuration

This section configures SATA controllers.

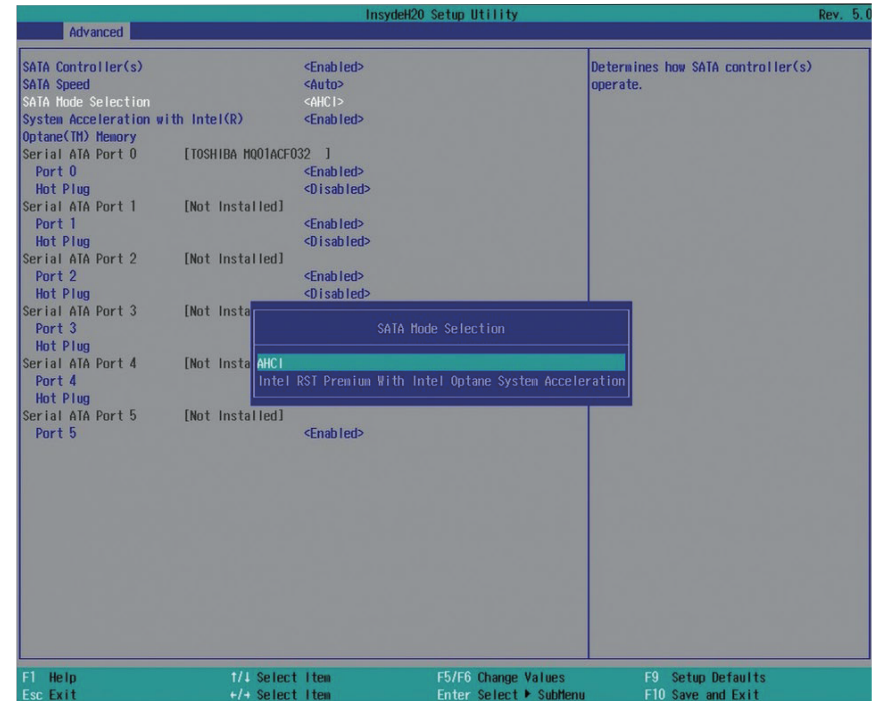

SATA Controller(s)

Enable or disable Serial ATA controllers.

SATA Speed

Select Serial ATA device speed from Gen1 (1.5 Gbit/s), Gen2 (3 Gbit/s), Gen 3 (6 Gbit/s) or auto.

SATA Mode Selection

The mode selection determines how the SATA controller(s) operates.

AHCI Mode

This option allows the Serial ATA devices to use AHCI (Advanced Host Controller Interface).

RAID Mode

This option allows you to create RAID using Intel® Rapid Storage Technology.

Intel RST Premium With Intel Optane System Acceleration Mode

Configure the SATA controller to use the "Intel RST Premium With Intel Optane System Acceleration" mode to use this technology to accelerate system performance and responsiveness. Note that only KD331-C236 supports Intel® Optane system acceleration.

Serial ATA Port 0 to 5 and Hot Plug

Enable or disable each Serial ATA port and its hot plug function.

SATA Port 5 controls the signal of the M.2 slot.

Note that for WM342-KD330 (KD330-H110), the SATA port will be numbered from 0 to 3. And for WM342-KD330 (KD330-Q170), it will be numbered from 0 to 4 (port 4 controls the signal of the Mini PCIe slot).

USB Configuration

This section configures the parameters of the USB devices.

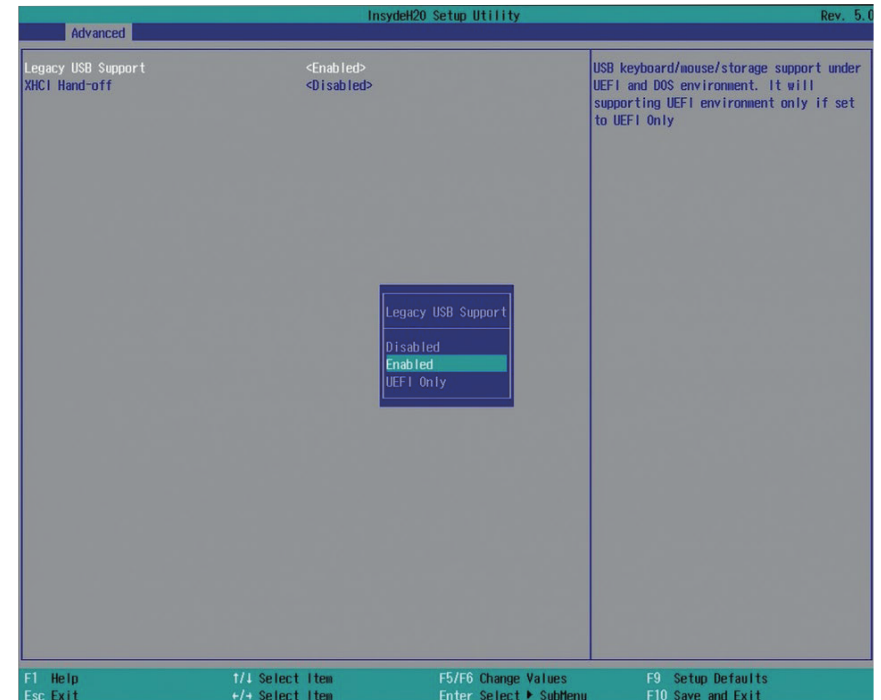

Legacy USB Support

Disabled

Disable USB keyboard/mouse/storage support.

Enabled

Enable USB keyboard/mouse/storage support.

UEFI Only

Enable USB keyboard/mouse/storage support only under the UEFI environment.

XHCI Hand-off

Enable this function for operating systems that do not support xHCI Hand-off. The XHCI ownership change will be claimed by the XHCI driver.

PCI Express Configuration

This section configures the settings of PCI Express root ports.

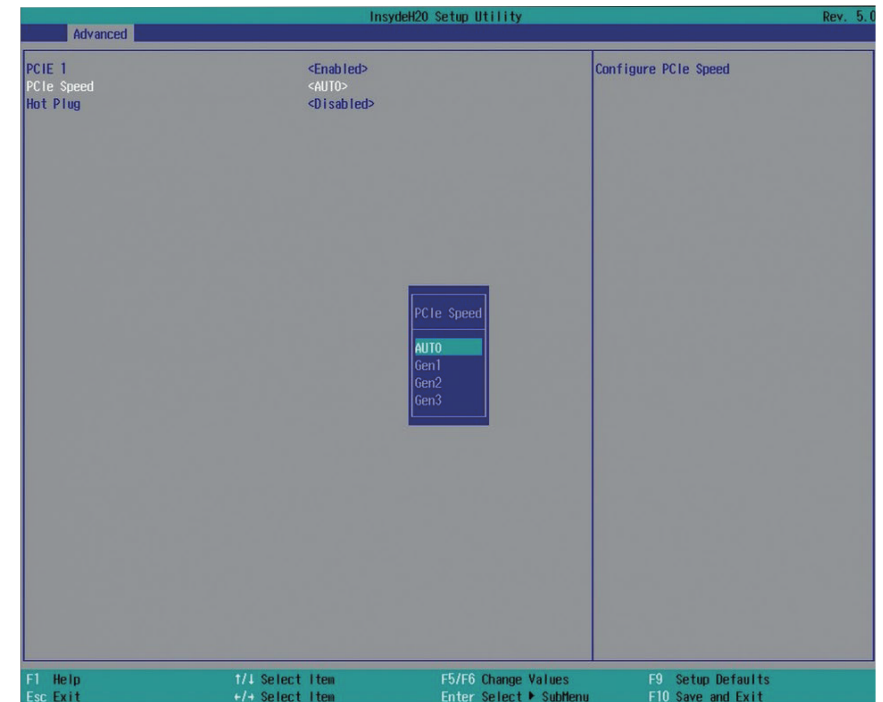
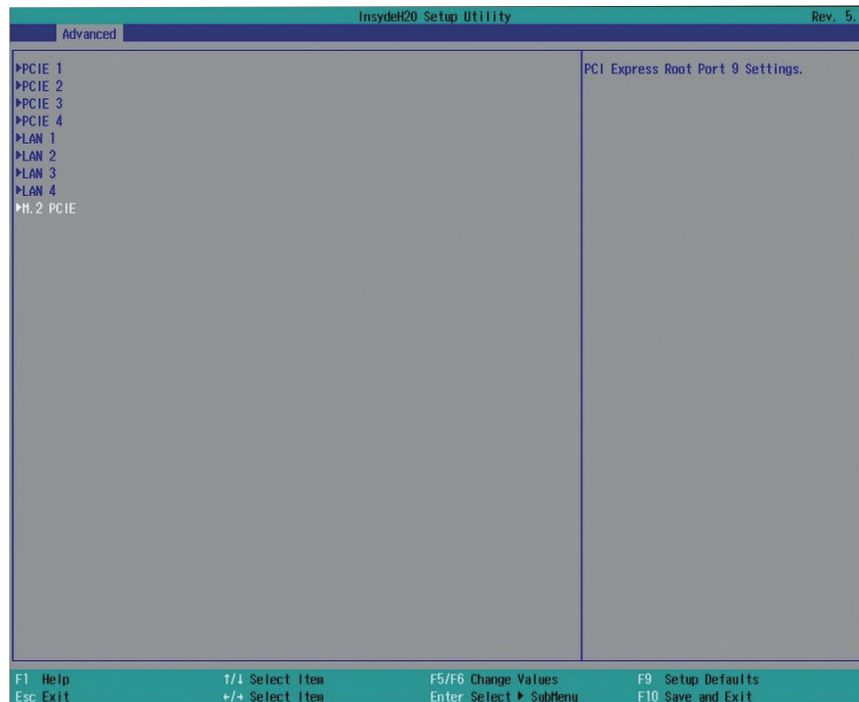

PCI Express Configuration

Select a PCI Express root port and press "Enter" to configure.

PCI Express Root Port

PCIE 1: PCIE1 slot

PCIE 2: PCIE2 slot

PCIE 3: PCIE3 slot (Note for KD330-Q170, this controls the signal of the full-size Mini PCIe slot)

PCIE 4: PCIE4 slot (Note this is only available for KD331-C236/Q170)

M.2 PCIe: M.2 slot (Note this is only available for KD331-C236/Q170)

LAN 1~LAN 4

LAN 3 and LAN 4 are only available for WM342-KD331.

For each PCIe root port above, press "Enter" to configure its speed and hog plug.

Enable/Disable

Enable or disable this PCI Express root port.

PCIe Speed

Select the speed of the PCI Express root port: Auto, Gen1 (2.5 GT/s), Gen2 (5 GT/s) or Gen3 (8 GT/s).

Hot Plug

Enable or disable the hot plug function of the PCIe root port.

ME Configuration

This section configures flashing of the Intel® Management Engine.

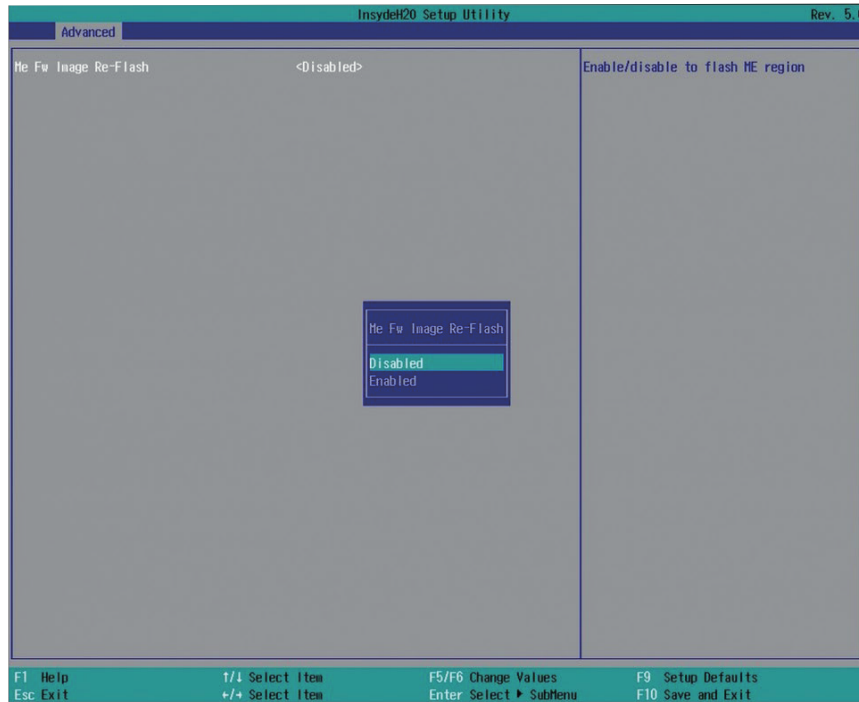

Me Fw Image Re-Flash

Enable or disable Intel® Management Engine firmware flashing when updating the BIOS.

Active Management Technology Support

The section allows you to enable or disable the Intel® Active Management Technology (Intel® AMT) BIOS extension. Refer to Chapter 10 - Intel AMT Settings for more information. Note that this function is not available for the Intel® Core™ i3, Intel® Pentium®, Intel® Celeron® processors or the Intel® H110 chipset.

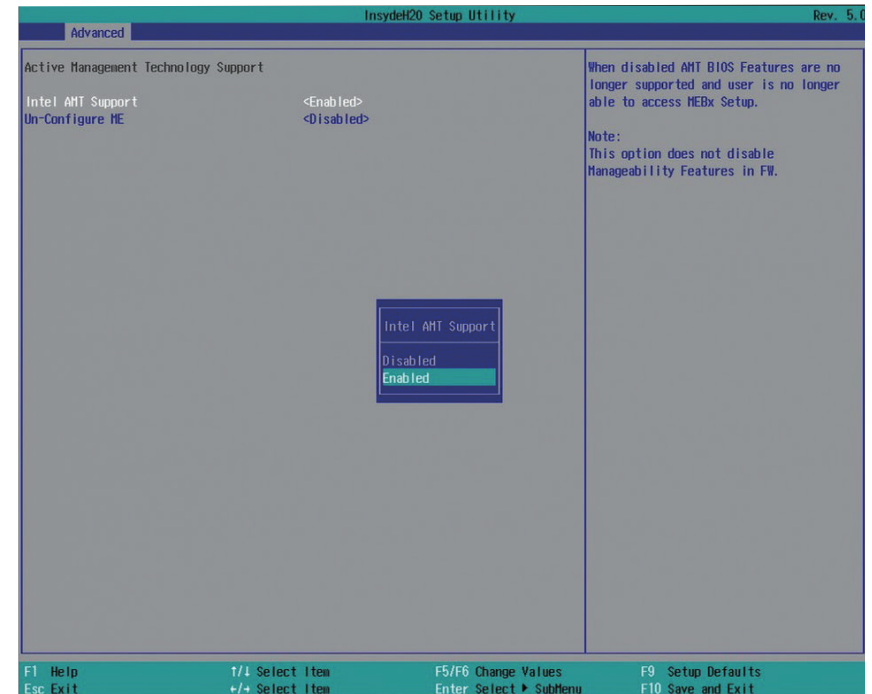

Intel AMT Support

Enable or disable Intel® Active Management Technology BIOS extension.

Un-Configure ME

Clears all ME related configurations without requiring a password on the next boot.

UEFI Device Manager

This Device Manager menu is used to configure UEFI network settings when the “Network Stack” or “UEFI” boot mode or when the PXE Boot to LAN is enabled in the “Legacy” boot mode. Refer to the “Boot” section in this chapter. After this function is selected, the screen will warn you that you are going to exit the BIOS setup utility.

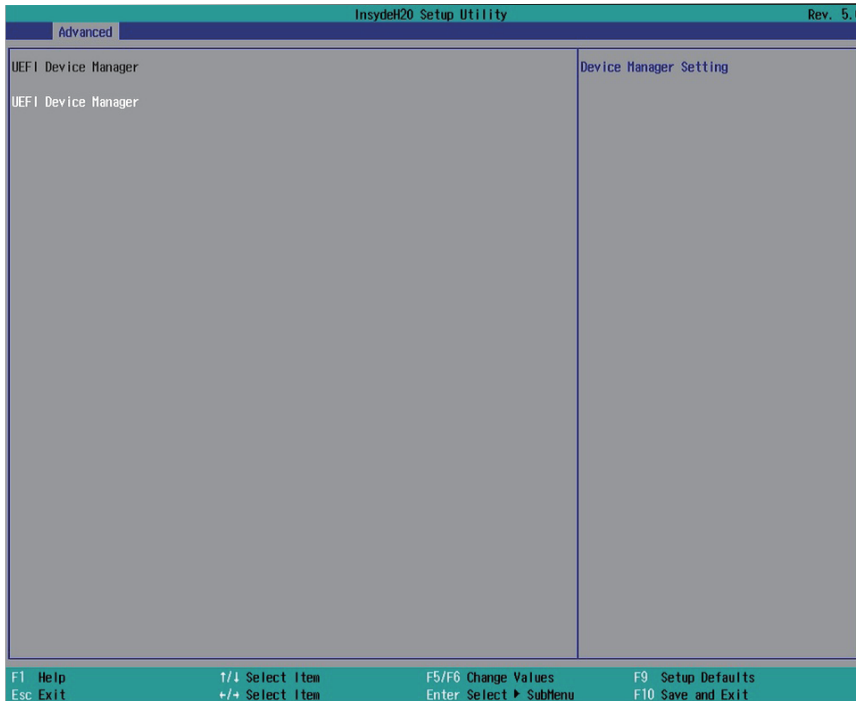

Network Device List

The “Device Manager” screen is displayed. And if the “Network Stack” or the “PXE Boot to LAN” option is enabled from the “Boot” menu, the “Network Device List” should be shown in the “Device list”. Select “Network Device List” to view all of the detected network devices. For each network device, you can select to view and configure its settings. In addition, you can select either the IPv4 or IPv6 network settings for UEFI network configuration.



NIC Configuration Menu

This screen shows hardware information for the Ethernet controllers and configures their operation.

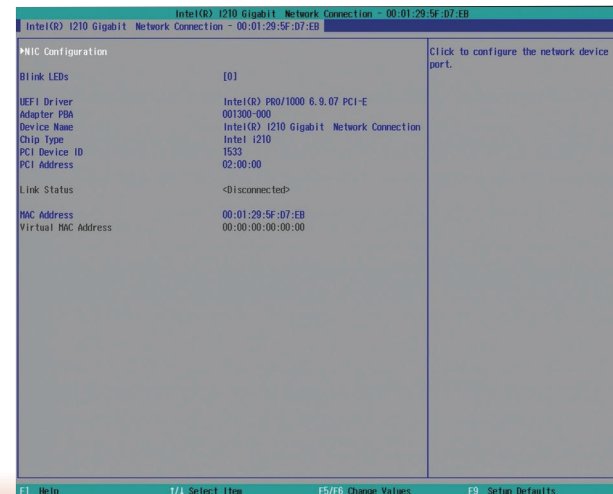

Blink LEDs

Enter the duration (seconds) for the Ethernet's LED to blink to indicate its presence.

NIC Configuration

This screen configures the Ethernet controller. Select the link speed from the following options: Auto Negotiated, 10Mbps Half, 10Mbps Full, 100Mbps Half, and 100Mbps Full.

IPv4 Network Configuration

This screen configures the IP addressing method (DHCP or static IP). For static IP addressing, configure the following:

Local IP address and subnet mask: Enter the IP address for the network device in the IPv4 format:

x . x . x . x (x must be a decimal value between 0 and 255).

Local Gateway: Enter the gateway address in the IPv4 format.

Local DNS (Domain Name System) Servers: Enter DNS (Domain Name System) server IP addresses in the IPv4 format.

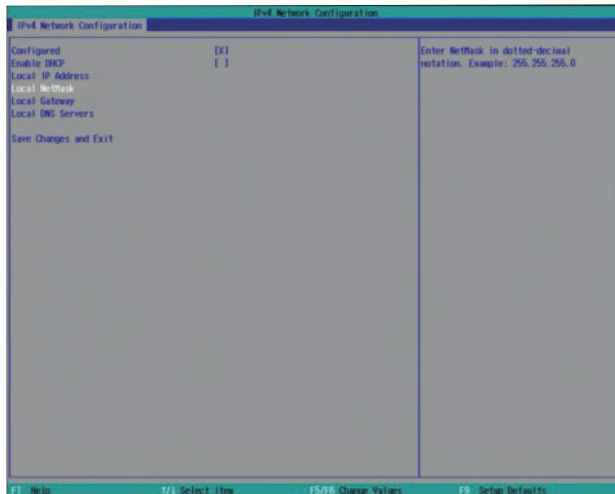

IPv6 Network Configuration

If you select to use IPv6 network settings, enter the Interface ID (64 bit). Policy: Select either automatic or manual. And select "Advanced Configuration" to configure IPv6 network address manually if the manual option is selected.

New IPv6 address: Enter the IP address for the network device in the IPv6 format:

x : x : x : x : x : x : x : x (x can be any hexadecimal value between 0 and FFFF). Place a space to separate each IP address to enter more than one address.

New Gateway addresses: Enter gateway addresses in the IPv6 format.

New DNS addresses: Enter DNS (Domain Name System) server IP addresses in the IPv6 format.



Super IO Configuration

This section configures the system super I/O chip parameters.

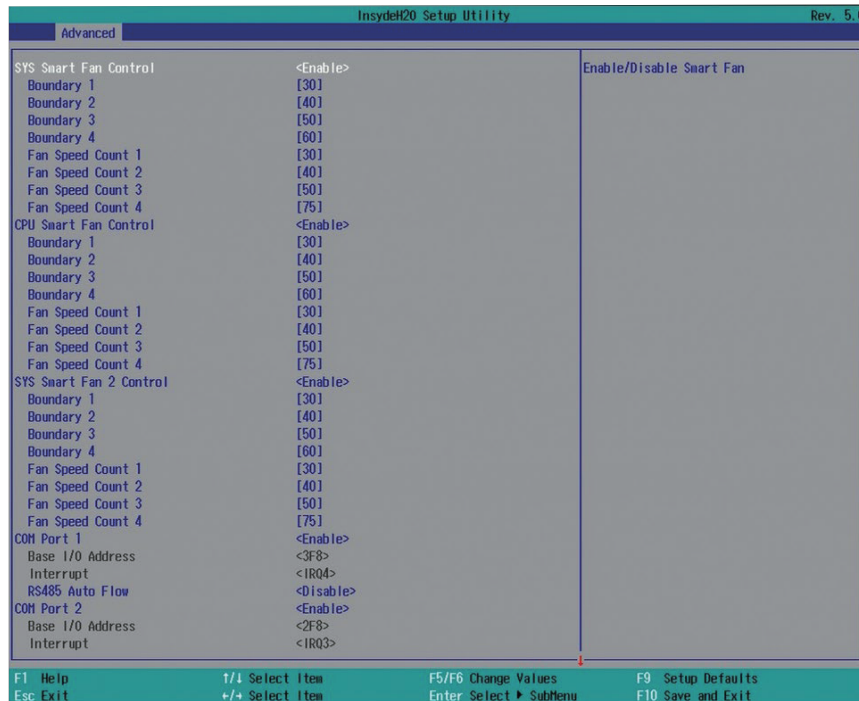

SYS Smart Fan/CPU Smart Fan/SYS Smart Fan 2 Control

Enable or disable the smart fan control.

Boundary 1 to Boundary 4

Set the boundary temperatures that determine the operation of the fan with different fan speeds accordingly. For example, when the system or the CPU temperature reaches boundary temperature 1, the system or CPU fan should be turned on and operate at the designated speed.

The range of the temperature is from 0 to 127°C.

Fan Speed Count 1 to Fan Speed Count 4

Set the fan speed. The range is from 1 (lowest speed)-100% (full speed).

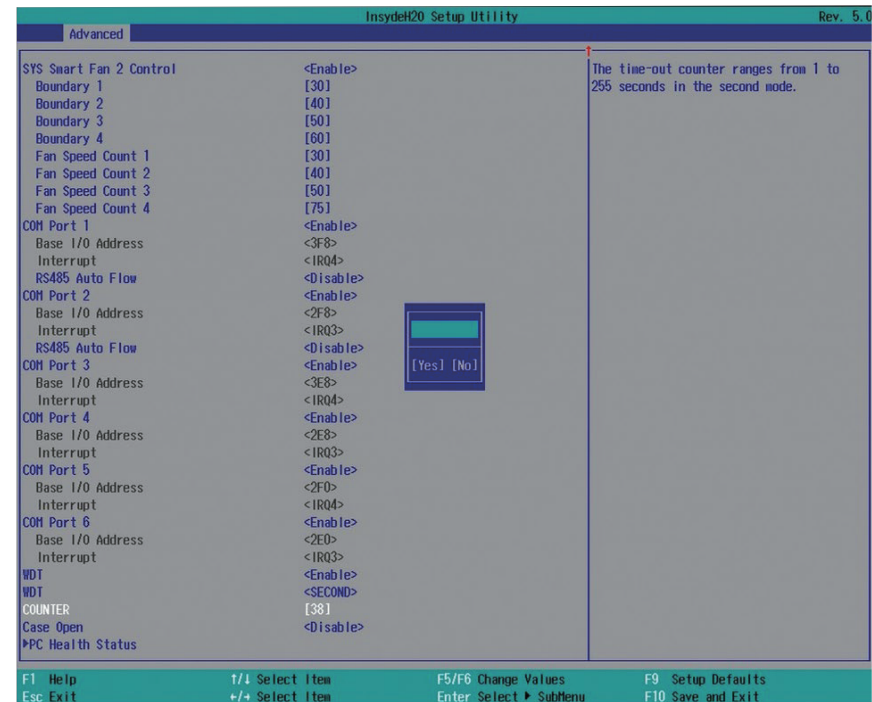

COM Port 1 and COM Port 6

Enable or disable each serial port.

Disable Disable this serial port.

Enable Enable this serial port.

It also shows the Base I/O address and the assigned interrupt number.

For COM Port 1 and COM Port 2, you can enable or disable the RS485 auto flow mechanism.

WDT

Enable or disable the watchdog function. A counter will appear if you select to enable WDT. Input any value between 1 and 255.

Case Open

Enable or disable the case open function.

PC Health Status

This section displays PC health information such as the voltages and CPU and system temperatures.

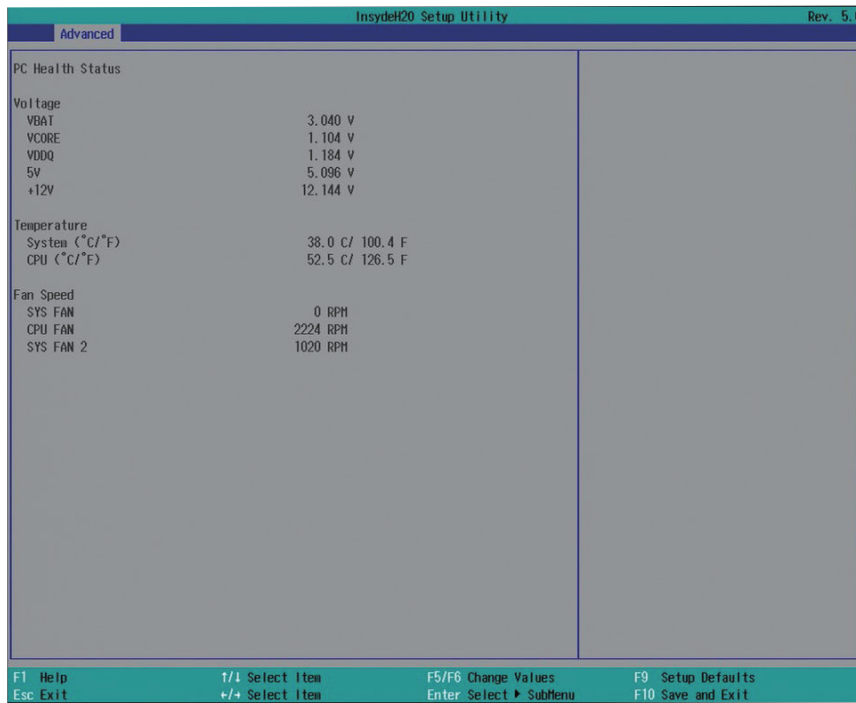

Console Redirection

Console redirection lets you monitor and control the system from a remote station by re-directing the host screen output through a serial port.

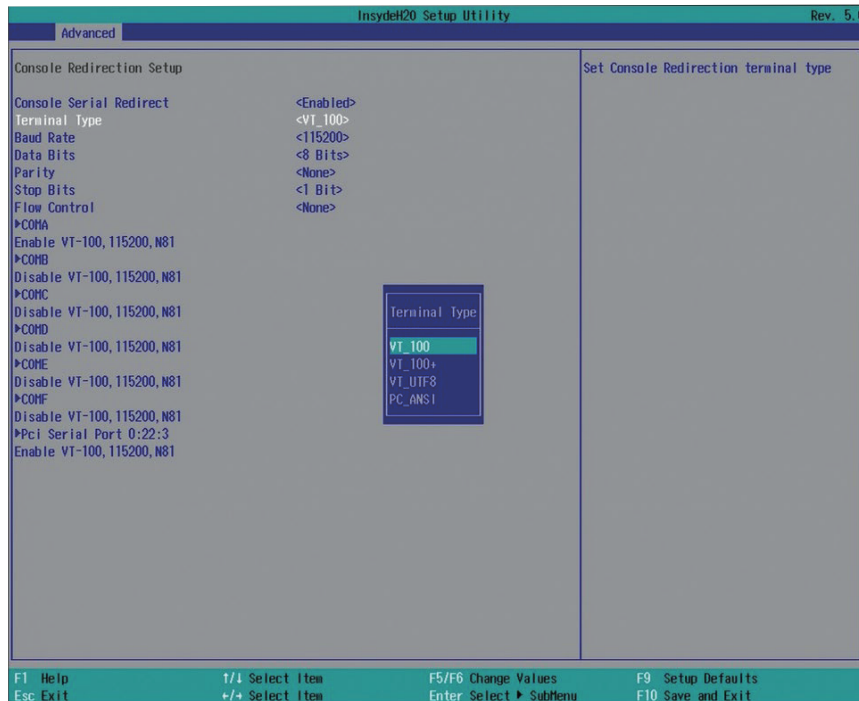

Console Serial Redirect

Enable or disable the console redirection function. (The default is disabled.) If you select to enable it, please configure the following parameters for serial communication between the system and a remote station:

Terminal type: VT_100, VT_100+, VT_UTF8, or PC_ANSI.

Baud rate: 115200, 57600, 38400, 19200, 9600, 4800, 2400 or 1200.

Data bits: 8 bits or 7 bits.

Parity: None, Even or Odd.

Stop bits: 1 bit or 2 bits.

Flow control: None, RTS/CTS or XON/XOFF

This is the global setting for all of the designated serial ports for the console redirection function.

COMA to COMF/PCI Serial Port

Enable or disable the serial redirection function for each of the serial ports on the system. And configure the serial communication parameters to be used between the system and a remote station.

UseGlobalSetting

Choose to use the pre-configured global settings from the previous menu or configure a different setting for each serial port.

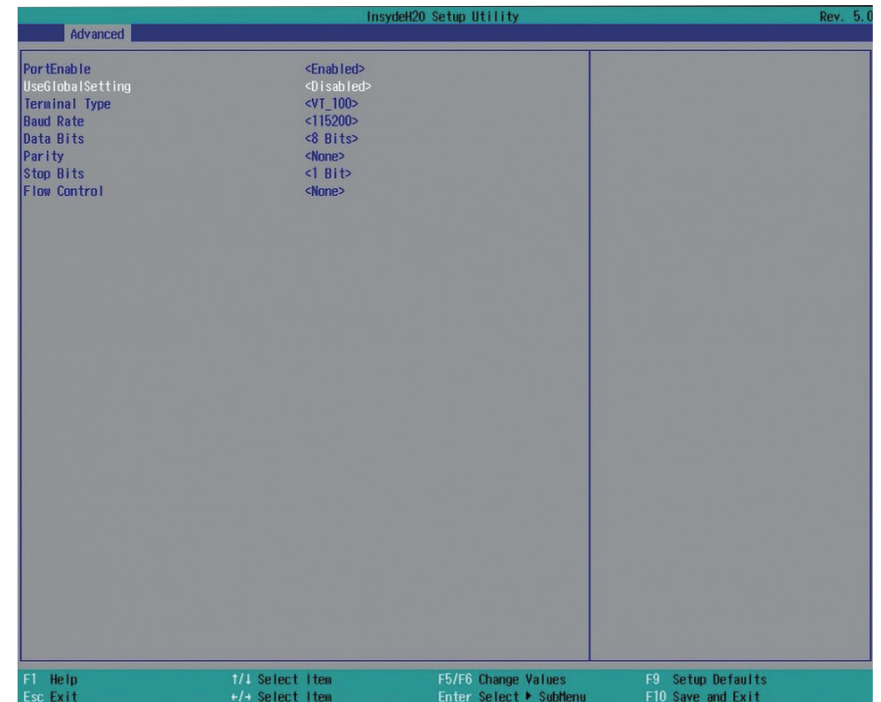

Security

This section configures the security for the BIOS Setup utility and the optional Trusted Platform Module (TPM) function.

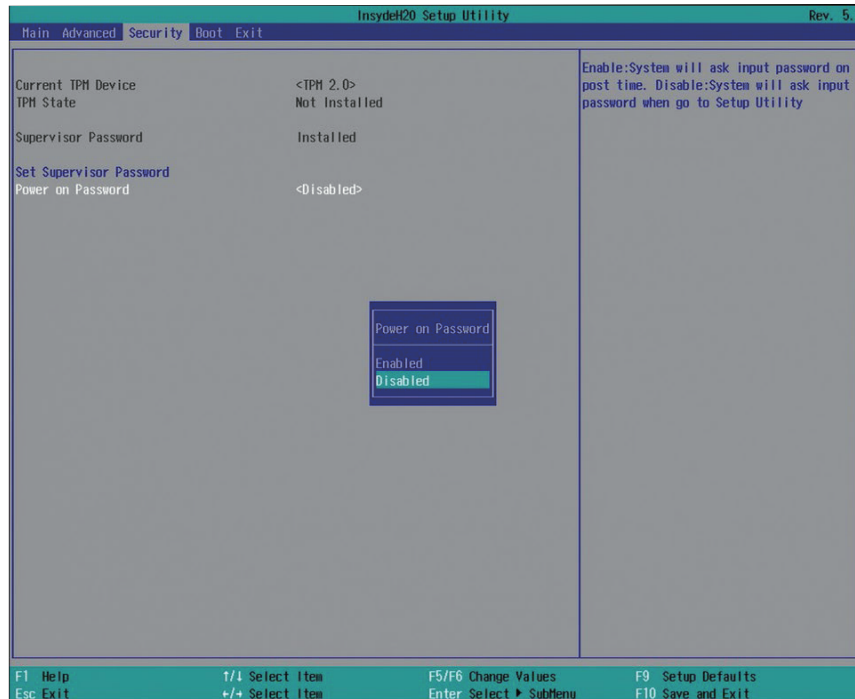

TPM Availability

Show or hide TPM availability and its configurations.

TPM Operation (optional)

Enable or disable the TPM function. It displays the following options:

- No Operation: No changes to the current state.
- Disable: Disable and deactivate TPM.
- Enable: Enable and activate TPM.

Clear TPM

Remove all TPM ownership contents.

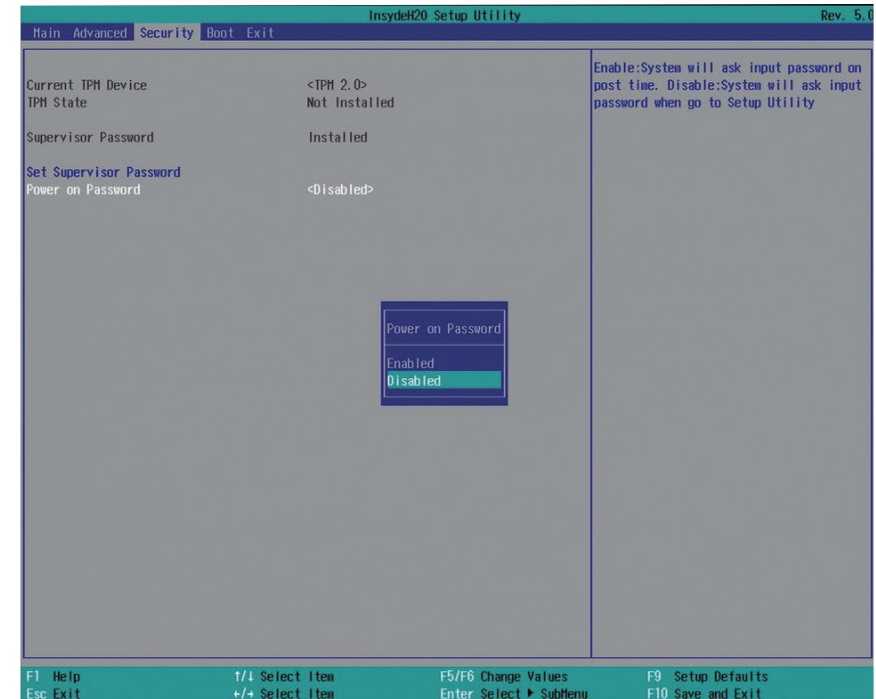

Set Supervisor Password

Set the administrative password for entering the BIOS utility or upon entering the power-on self-test (POST) process. The length of the password must be greater than 1 character and less than or equal to 10 characters.

Power-on Password

If you select to set the supervisor password, this option will be shown. Enable or disable prompt for password at boot.

Boot

This section configures boot options.



Numlock

Select the power-on state for the Num Lock key.

Boot Type

Select the boot type. The options are Dual Boot, Legacy Boot and UEFI Boot Type.

Network Stack

This option is shown only when the boot type is set to Dual or UEFI.

Enable or disable UEFI network stack. It supports the operation of these functions or software: Windows 8 BitLocker Network Unlock, UEFI IPv4/IPv6 PXE and legacy PXE option ROM. If this function is enabled, you can then go to "Advanced">"Device Manager" to configure network settings for network connection under the UEFI environment.

PXE Boot Capability (UEFI mode) / PXE Boot to LAN (Legacy mode)

Enable or disable Preboot eXecution Environment (PXE) boot to LAN. In the UEFI or Dual boot mode, this function can only be enabled if the Network Stack support is enabled.

USB Boot

Enable or disable booting to USB boot devices.

Quiet Boot

Enable or disable the quiet boot function to configure the screen's display between POST messages or the OEM logo at bootup. Select Disabled to display the POST messages and select Enabled to display the OEM logo.

Boot Device Priority

This section configures legacy or EFI boot order or both depending on the "Boot Type" selected.



EFI Boot Menu

Use + and - keys to arrange the priority of the boot devices in the list.

Legacy Boot Menu

Normal

For this option, determine the boot order for the devices within each category. Use the + and - key to arrange the priority of the boot type devices in the list. The first device in the list has the highest boot priority.

Advance

For this option, determine the boot order for all bootable devices. Use + and - keys to arrange the priority of the detected boot devices in the list. The first device in the list has the highest boot priority.

Exit

This section configures the parameters for exiting the BIOS setup utility.

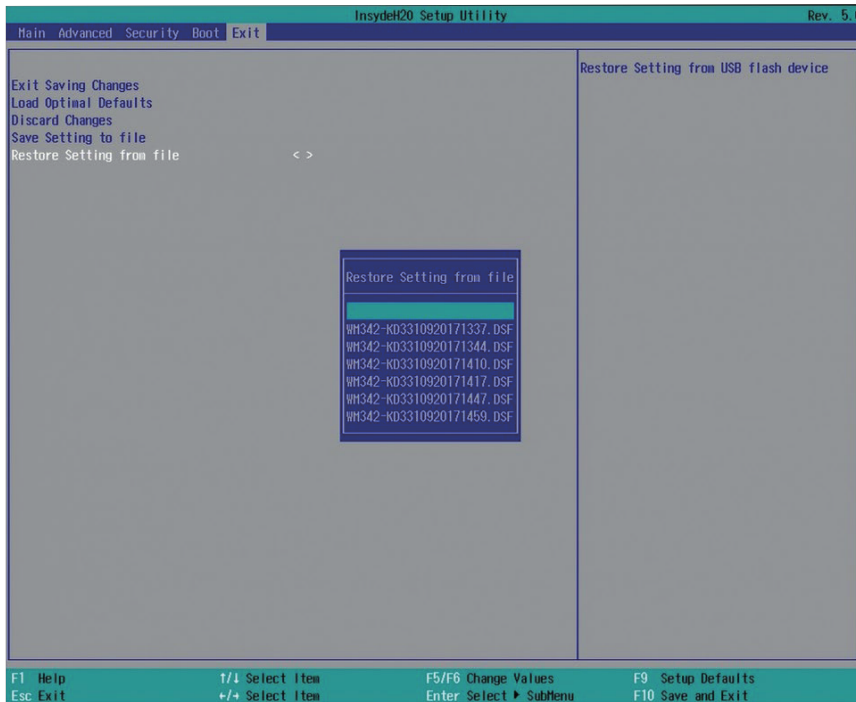

Exit Saving Changes

Select this field and press <Enter> to exit BIOS setup and save your changes.

Load Optimal Defaults

Select this field and press <Enter> to load the optimal defaults.

Discard Changes

Select this field and press <Enter> to exit the BIOS setup without saving your changes.

Save Setting to file

Select this option to save BIOS configuration settings to a USB drive. The operation will fail if there aren't any USB devices detected on the system. The saved configuration will have the DSF file extension and can be used for restoration.

Restore Setting from file

Select this option to restore BIOS configuration settings from a USB drive. Note that this option appears only if a USB device is detected on the system.

Updating the BIOS

To update the BIOS, you will need an updated BIOS file and a flash utility. Please contact technical support or your sales representative for the files and specific instructions on how to update BIOS with the flash utility.

When you download the given BIOS file, you may find a BIOS flash utility attached with the BIOS file. This is the utility for performing the BIOS update procedure. For your convenience, we will also provide you with an auto-execution file in the BIOS file downloaded. This auto-execution file will bring you directly to the flash utility menu soon after system boots up and finishes running the boot files in your boot disk.

```

Read file successfully. (path= "platform.ini")

Information
Please do not remove the AC power

Insyde H20FFT (Flash Firmware Tool) Version (SEG) 100.00.08.10
Copyright(c) 2012 - 2017, Insyde Software Corp. All Rights Reserved.

Initializing
Current BIOS Model name: KD330
New BIOS Model name: KD330

Current BIOS version: B17A.31A
New BIOS version: B18A.31A

Updating Block at FFFFF000h
0%      25%      50%      75%      100%
C:\KD330>_

```

Notice: BIOS SPI ROM

1. The Intel® Management Engine has already been integrated into this system board. Due to safety concerns, the BIOS (SPI ROM) chip cannot be removed from this system board and used on another system board of the same model.
2. The BIOS (SPI ROM) on this system board must be the original equipment from the factory and cannot be used to replace one which has been utilized on other system boards.
3. If you do not follow the methods above, the Intel® Management Engine will not be updated and will cease to be effective.



Note:

- a. You can take advantage of flash tools to update the default configuration of the BIOS (SPI ROM) to the latest version anytime.
- b. When the BIOS IC needs to be replaced, you have to populate it properly onto the system board after the EEPROM programmer has been burned and follow the technical person's instructions to confirm that the MAC address should be burned or not.

Chapter 8 - Supported Software

The system requires you to install drivers for some devices to operate properly. To download the latest driver, please go to the DFI Download Center:

<http://www.dfi.com/DownloadCenter>

Once you are in the Download Center page, select your product or type the model name and click "Search" to find product-related resources such as documentation and drivers.

Drivers are available for the following devices in Windows 10:

- Intel® Chipset Device Software
- Intel® Graphics Driver
- Intel® LAN Driver
- Intel® ME Driver
- Intel® Rapid Storage Technology Driver
- Audio Driver
- Intel® Serial IO Driver

Intel Chipset Device Software

The Intel® Chipset Device Software is used for updating Windows® INF files so that the Intel chipset can be recognized and configured properly in the system.

To install the utility, follow these steps:

1. Setup is ready to install the utility. Click "Next".



2. Read the license agreement, and then click "Yes".

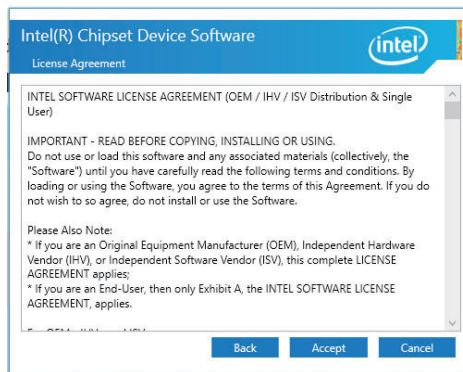

3. Go through the readme document for system requirements and installation tips, and then click "Next". Please wait while the installation is in progress.

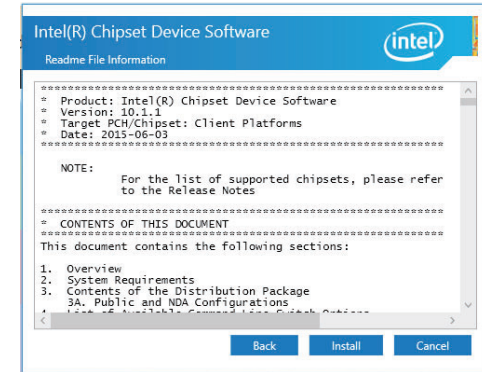

4. Please wait while the installation is in progress.

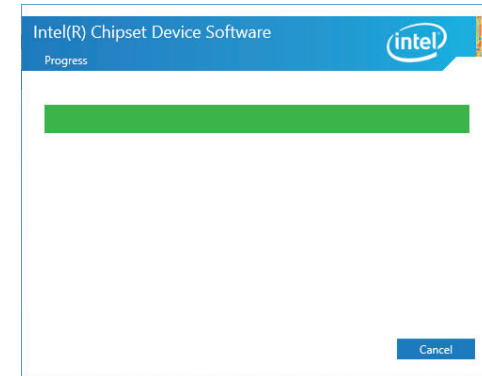

5. Click "Restart Now" to allow the new software installation to take effect.



Intel Graphics Driver

To install this driver, follow these steps:

1. Setup is now ready to install the graphics driver. Click "Next".

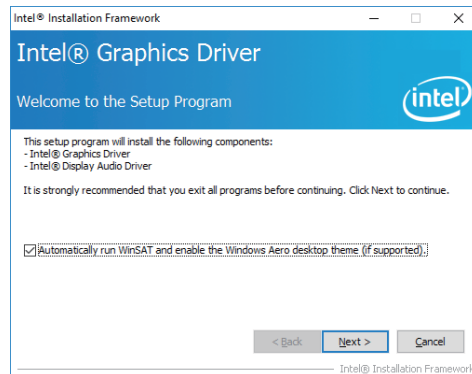

By default, the "Automatically run WinSAT and enable the Windows Aero desktop theme" is enabled. When this is enabled and after the system reboots, the screen will turn blank for 1 to 2 minutes (while WinSAT is running) before the Windows 7/ Windows 8.1/ Windows 10 desktop appears. The "blank screen" period is the time Windows is testing the graphics performance.

We recommend that you skip this process by disabling this function and then click "Next".

2. Read the license agreement, and then click "Yes".

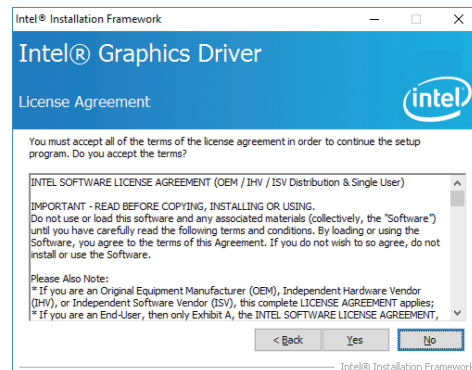

3. Go through the readme document for system requirements and installation tips, and then click "Next".

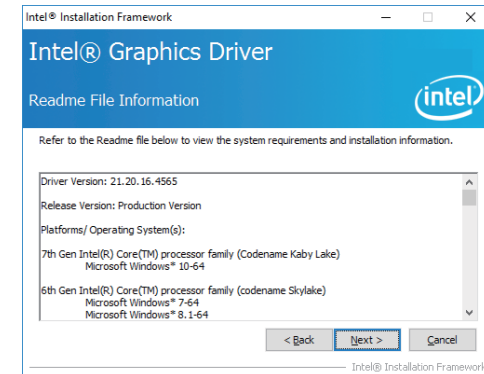

4. Setup is now installing the driver. Click "Next" to continue.

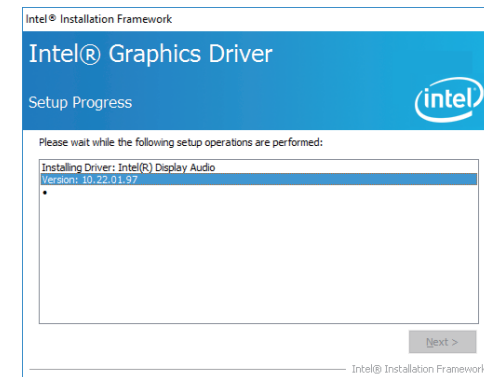

5. Click "Yes, I want to restart this computer now", and then click "Finish".

Restarting the system will allow the new software installation to take effect.

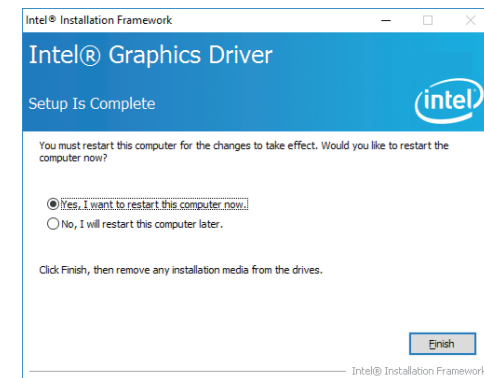

Intel LAN Driver

To install this driver, follow these steps:

1. Setup is preparing to install the driver. Click "Next" to continue.

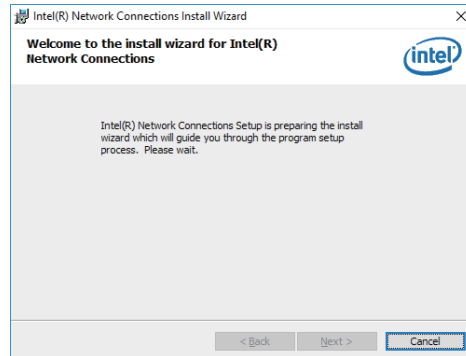

2. Click "I accept the terms in the license agreement" if you accept the agreement, and then click "Next".

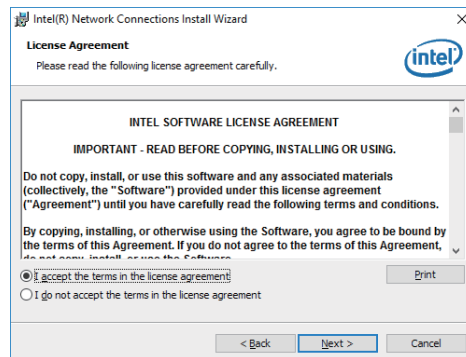

3. Select the program features you want to install, and then click "Next".

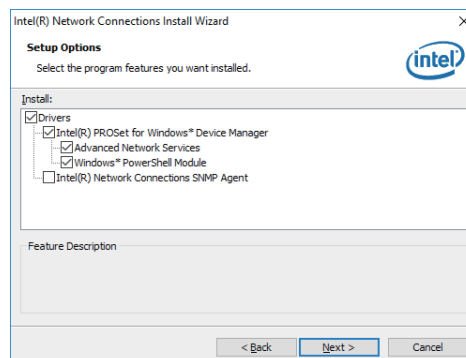

4. Click "Install" to begin the installation.

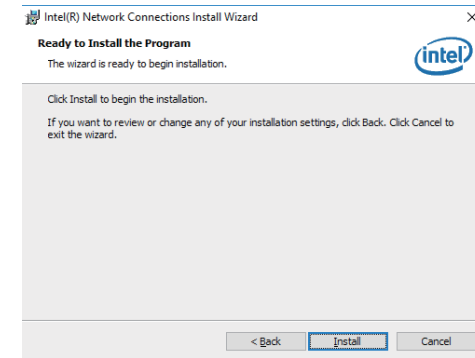

5. After the installation is complete, click "Finish".

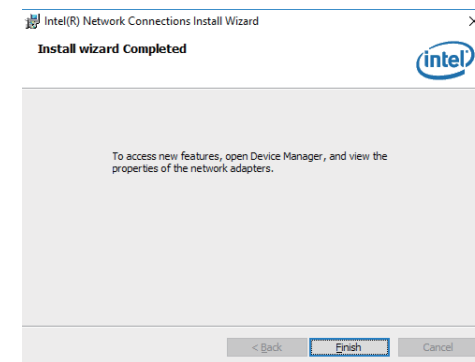

Intel ME Driver

To install the Intel® Management Engine (Intel® ME) Driver, follow these steps:

1. You are about to install the driver. Click "Next" to continue.

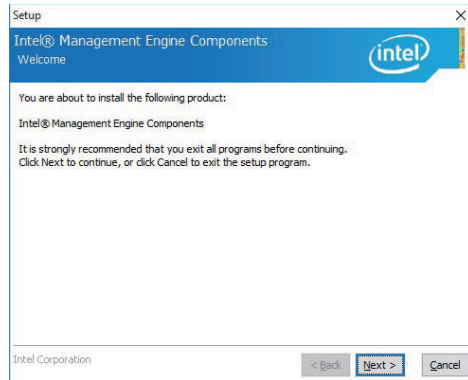

2. Read the license agreement, and then click "Next".

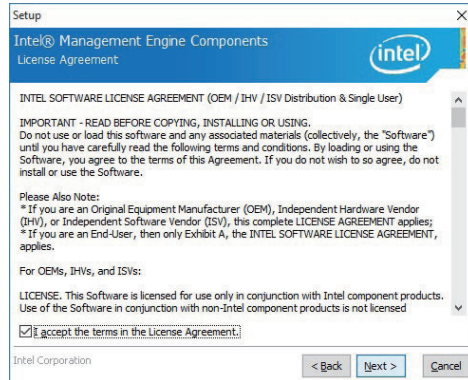

3. Setup is currently installing the driver. After the installation is complete, click "Next."

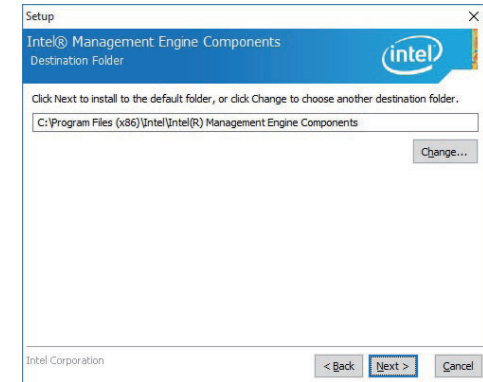

4. Please wait while the product is being installed.

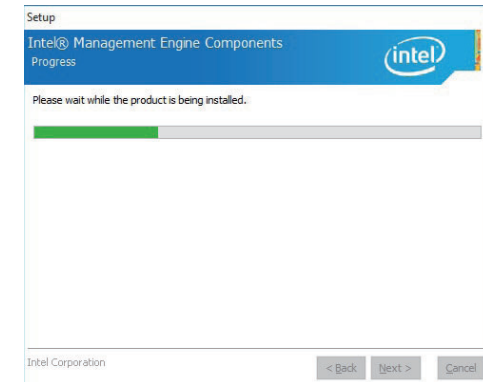

5. After the installation is complete, click "Finish".

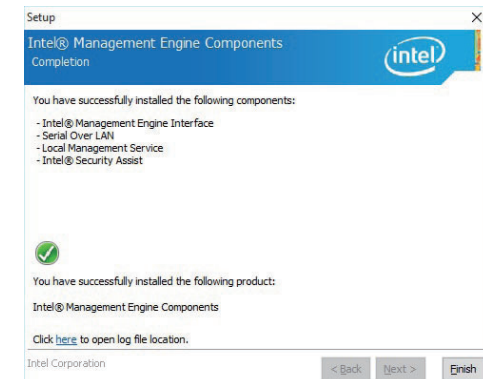

Audio Driver

To install this driver, follow these steps:

1. Setup is now ready to install the audio driver. Click "Next".
2. Follow the steps of the on-screen instructions; click "Next" each time you finish a step.

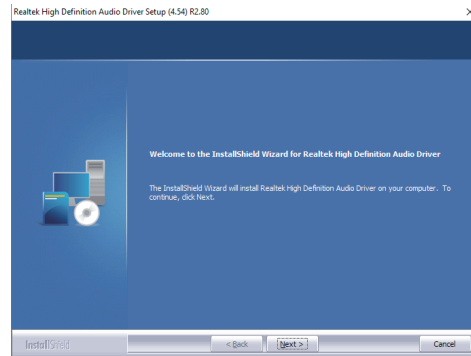

3. Click "Yes, I want to restart my computer now", and then click "Finish".

Restart the system to allow the new software installation to take effect.

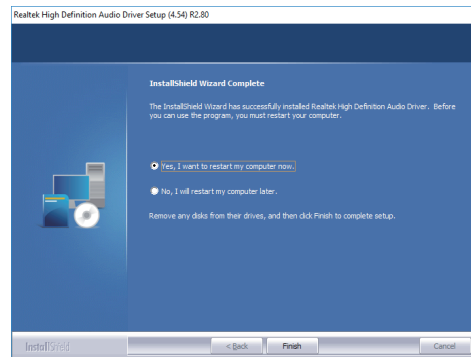

Serial IO Driver

To install this driver, follow these steps:

1. Setup is ready to install the driver. Click "Next" to continue.

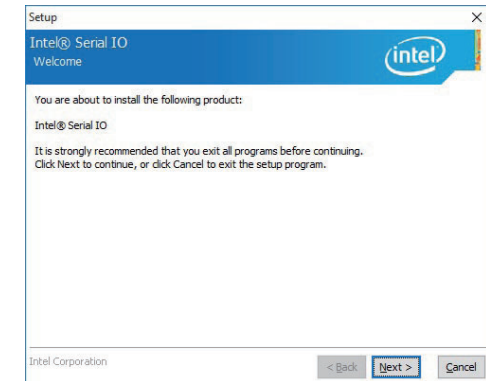

2. Read the license agreement carefully.

Click "I accept the terms in the License Agreement" if you agree with the terms in the agreement and then click "Next".



3. Read the file information and then click "Next".

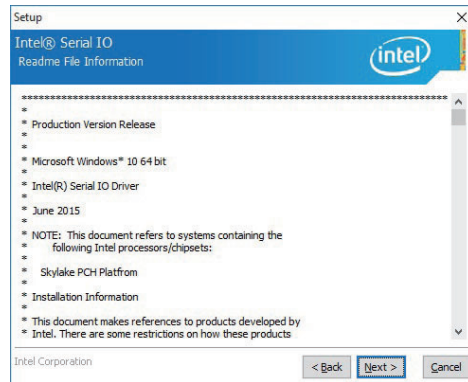

5. Setup is now installing the driver.

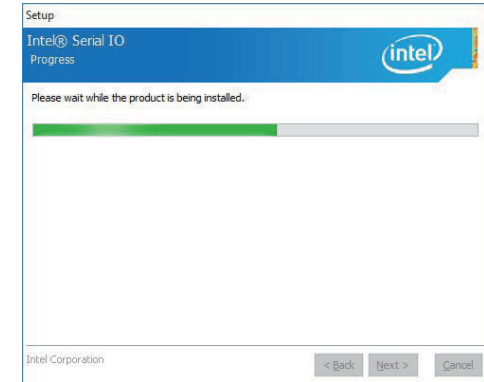

4. Setup is ready to install the driver. Click "Next" to begin the installation.

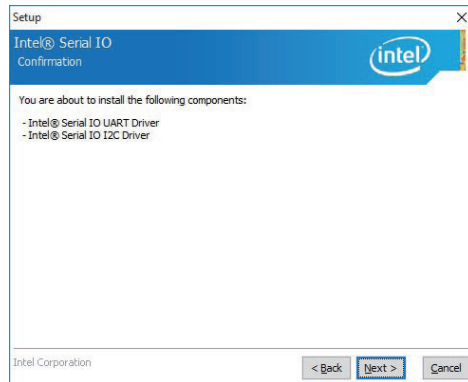

6. Click "Finish" to exit the setup.

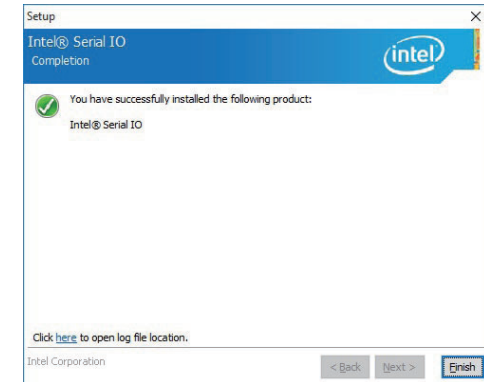

Intel® Rapid Storage Technology Driver

The Intel Rapid Storage Technology is a utility that allows you to monitor the current status of the SATA drives. It enables enhanced performance and power management for the storage subsystem. You can also install and set up Intel® Optane™ memory with the Intel® Rapid Storage Technology application.

Please refer to **Chapter 9** for more information.

Chapter 9 - RAID

The system board allows RAID configuration with levels of RAID 0, RAID 1, RAID 5 and RAID 10.

RAID Levels

RAID 0 (Striped Disk Array without Fault Tolerance)

RAID 0 uses two new identical hard disk drives to read and write data in parallel, interleaved stacks. Data is divided into stripes and each stripe is written alternately between two disk drives. This improves the I/O performance of the drives at different channel; however it is not fault tolerant. A failed disk will result in data loss in the disk array.

RAID 1 (Mirrored Disk Array with Fault Tolerance)

RAID 1 copies and maintains an identical image of the data from one drive to the other drive. If a drive fails to function, the disk array management software directs all applications to the other drive since it contains a complete copy of the drive's data. This enhances data protection and increases fault tolerance to the entire system. Use two new drives or an existing drive and a new drive but the size of the new drive must be the same or larger than the existing drive.

RAID 5 (Striped Disk Array with Distributed Parity)

RAID 5 stripes data and parity information across hard drives. It is fault tolerant and provides better hard drive performance and higher disk utilization than RAID 1.

RAID Level	Min. Drives	Protection	Description
RAID 0	2	None	Data striping without redundancy
RAID 1	2	Single Drive Failure	Disk mirroring
RAID 5	3	Single Drive Failure	Block-level data striping with distributed parity

Settings

To enable the RAID function, the following settings are required.

1. Connect the Serial ATA drives.
2. Enable RAID in the BIOS.
3. Create a RAID volume.
4. Install the Intel Rapid Storage Technology Utility.

Step 1: Connect the Serial ATA Drives

Refer to carrier board manual for details on connecting the Serial ATA drives.



Important:

1. Make sure you have installed the Serial ATA drives and connected the data cables otherwise you won't be able to enter the RAID BIOS utility.
2. Treat the cables with extreme caution especially while creating RAID. A damaged cable will ruin the entire installation process and operating system. The system will not boot and you will lost all data in the hard drives. Please give special attention to this warning because there is no way of recovering back the data.

Step 2: Enable RAID in the BIOS

1. Power on the system then press to enter the main menu of the BIOS.
2. Go to "Advanced" menu, and select the "SATA Configuration" menu.
3. Change the "SATA Mode Selection" to "RAID" mode.
4. Save the changes in the "Exit" menu.
5. Reboot the system.

Step 3: Create a RAID Volume

1. When the Intel® RST option ROM status screen displays during POST, press <Ctrl> and <I> simultaneously to enter the option ROM user interface.
2. Select 1: Create RAID Volume and press <Enter>.
3. Use the up or down arrow keys to select the RAID level and press <Enter>.
4. Use the up or down arrow keys to select the strip size and press <Enter>.
5. Press <Enter> to select the physical disks.
6. Use the up or down arrow keys to scroll through the list of hard drives and press <Space> to select the drive.
7. Press <Enter>.
8. Select the volume size and press <Enter>. You must select less than one hundred percent of the available volume space to leave space for the second volume.
9. Press <Enter> to create the volume.
10. At the prompt, press <Y> to confirm volume creation.
11. Select 4: Exit and press <Enter>.
12. Press <Y> to confirm exit.



Note:

These steps are cited from the Intel® Support site, "Set Up a System with Intel® Matrix RAID Technology" (Article ID: 000005789).

Step 3-1: Create a RAID Volume if the boot type is UEFI

If the boot type is set to UEFI, RAID volume creation will be different. Please use the following steps to create RAID volumes. To set the boot type, enter the BIOS utility and go to "Boot" > "Boot type".

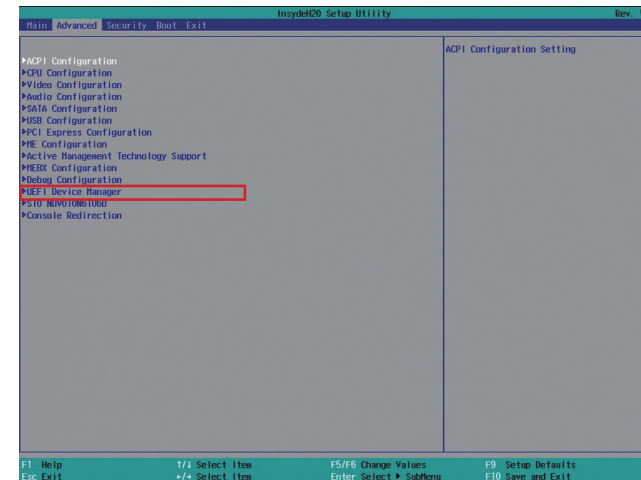
1. In the BIOS, go to the "Advanced" > "UEFI Device Manager".



2. Select Device Manager. The system will prompt you that it is going to exit the BIOS utility. Select "OK" to continue.
3. The "Intel® Rapid Storage Technology" menu appears. Enter this menu.



- The screen displays all available drives. Select "Create RAID volume" to create a RAID volume".
- Use the up or down arrow keys to select the RAID level and press <Enter>.
- Use the up or down arrow keys to scroll through the list of hard drives and press <Enter> and select "x" to select the drive for the RAID group.
- Use the up or down arrow keys to select the strip size and press <Enter>.
- Enter the capacity for the volume and press <Enter>.
- Select "Create Volume" to start creating the volume.

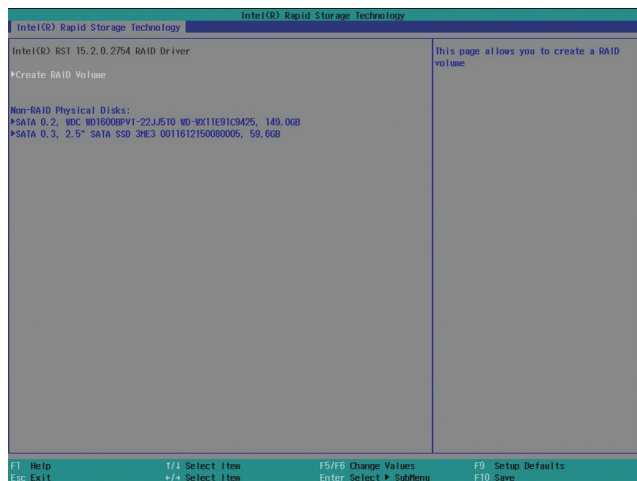

Step 4: Install the Intel Rapid Storage Technology Utility

The Intel Rapid Storage Technology Utility can be installed from within Windows. It allows RAID volume management (create, delete, migrate) from within the operating system. It will also display useful SATA device and RAID volume information. The user interface, tray icon service and monitor service allow you to monitor the current status of the RAID volume and/or SATA drives. Furthermore, It enables enhanced performance and power management for the storage subsystem.

- Insert the provided DVD into an optical drive.
- Click "Intel Rapid Storage Driver" on the main menu.
- Setup is ready to install the utility. Click "Next" to continue.

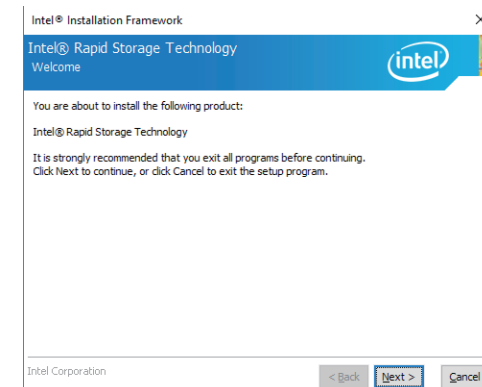

- Read the license agreement and click "I accept the terms in the License Agreement" if you accept the agreement. Then, click "Next".



5. Go through the readme document to view system requirements and installation information, then click "Next".

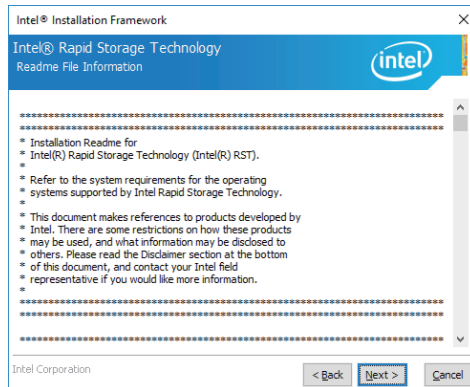

6. Click "Next" to install to the default folder or click "change" to choose another destination folder.

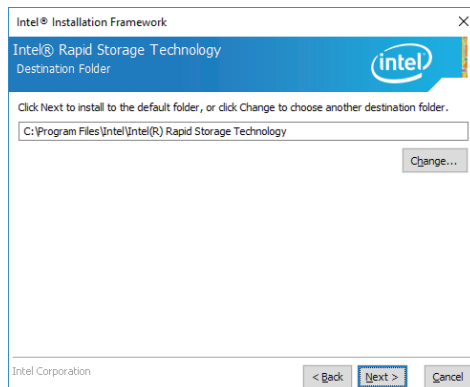

7. Confirm the installation and click "Next".

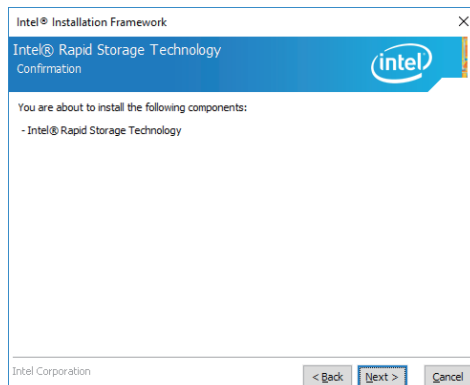

8. Click "Yes, I want to restart this computer now" to complete the installation and click "Finish".

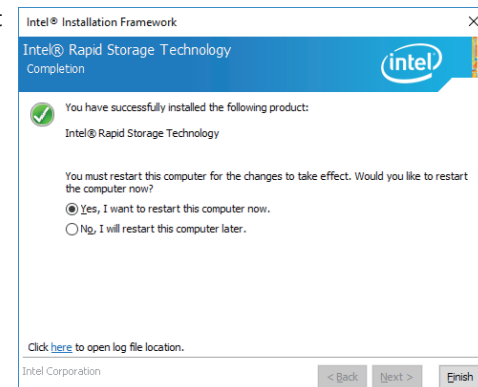

Chapter 10 - Intel AMT Settings

Overview

Intel Active Management Technology (Intel® AMT) combines hardware and software solutions to provide maximum system defense and protection to networked systems. Note that SKUs with the Intel® H110 chipset or Intel® Core™ i3, Celeron® and Pentium® processors do not support iAMT.

The hardware and software information are stored in non-volatile memory. With its built-in manageability and latest security applications, Intel® AMT provides the following functions.

- **Discover**

Allows remote access and management of networked systems even while PCs are powered off; significantly reducing desk-side visits.

- **Repair**

Remotely repair systems after OS failures. Alerting and event logging help detect problems quickly to reduce downtime.

- **Protect**

Intel AMT's System Defense capability remotely updates all systems with the latest security software. It protects the network from threats at the source by proactively blocking incoming threats, reactively containing infected clients before they impact the network, and proactively alerting when critical software agents are removed.

Enable Intel® AMT in the Insyde BIOS

1. Power on the system then press to enter the main menu of the BIOS setup utility.
2. In the "Advanced" menu, select "Active Management Technology Support".

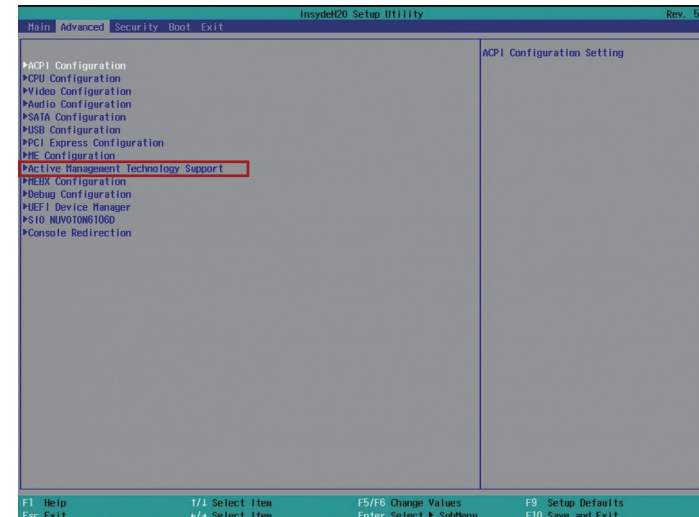

3. In the "Active Management Technology Support" menu, select "Enabled" for "Intel AMT Support".

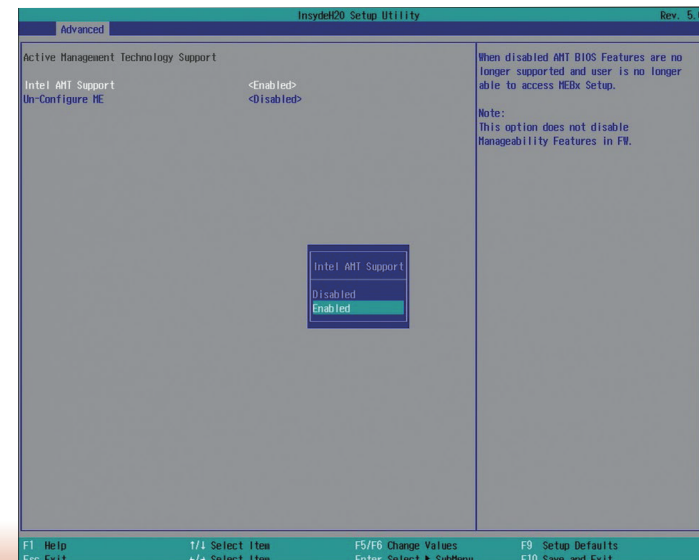

4. In the "Exit" menu, select "Exit Saving Changes" and then select "OK".

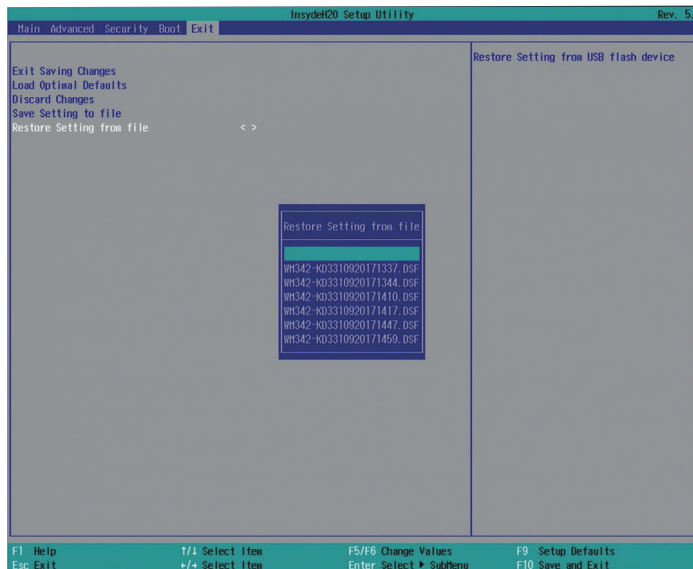

Set up Intel® AMT using the Intel® Management Engine BIOS Extension (MEBX)

1. After the system reboots, press to enter the BIOS menu again.
2. In the "Advanced" menu, select "MEBX Configuration" to enter the Manageability Engine BIOS Extension (MEBx) Setup.
3. When the system reboots, you will be prompted for a password. The default password is "admin". Enter the default password in the space provided under Intel(R) ME Password, then press "Enter".

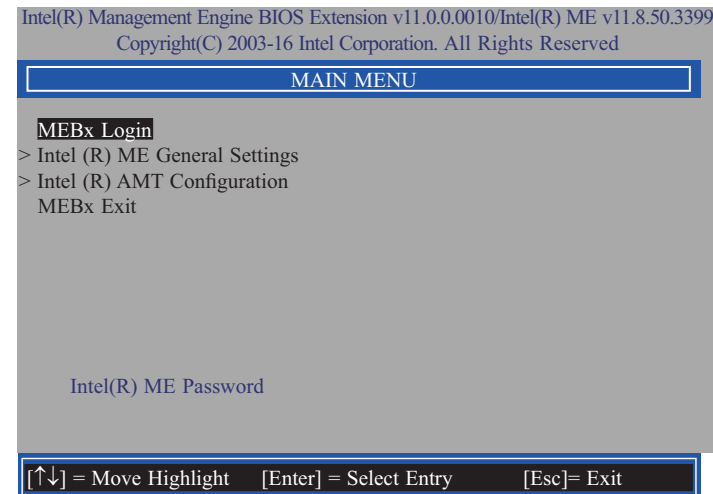

4. Enter a password in the space provided under "Intel(R) ME Password" and then press "Enter". The password must include:

- 8-32 characters
- Strong 7-bit ASCII characters excluding : , and " characters
- At least one digit character (0, 1, ...9)
- At least one 7-bit ASCII non alpha-numeric character, above 0x20, (e.g. !, \$, ;)
- Both lower case and upper case characters

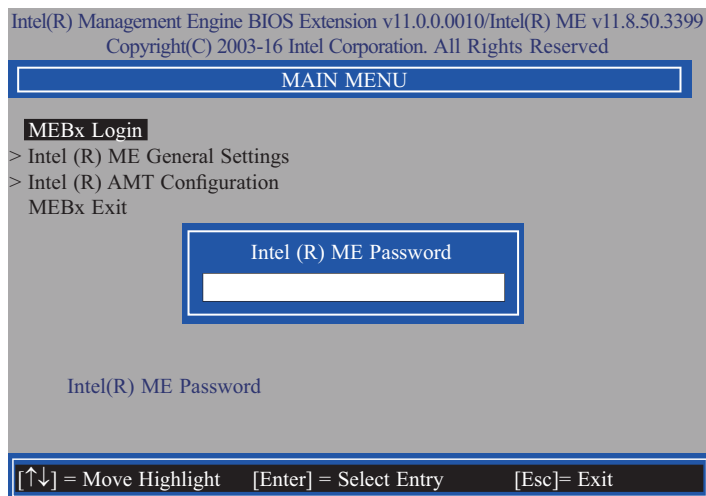

5. You will be asked to verify the password. Enter the same new password in the space provided under "Verify Password" and then press "Enter".

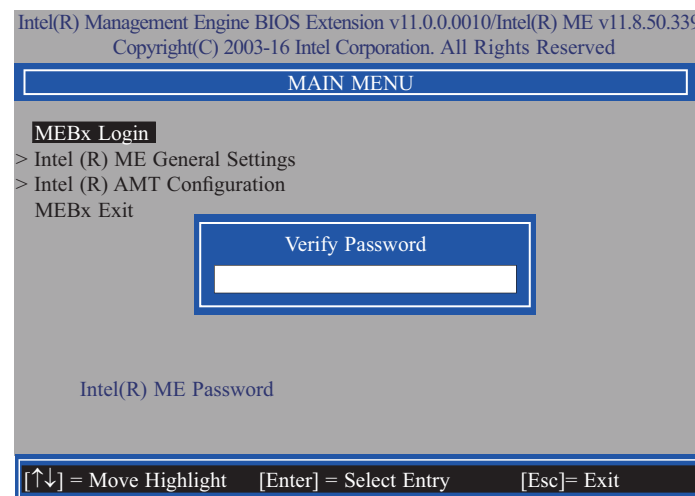

6. Select "Intel(R) ME General Settings" and then press "Enter".

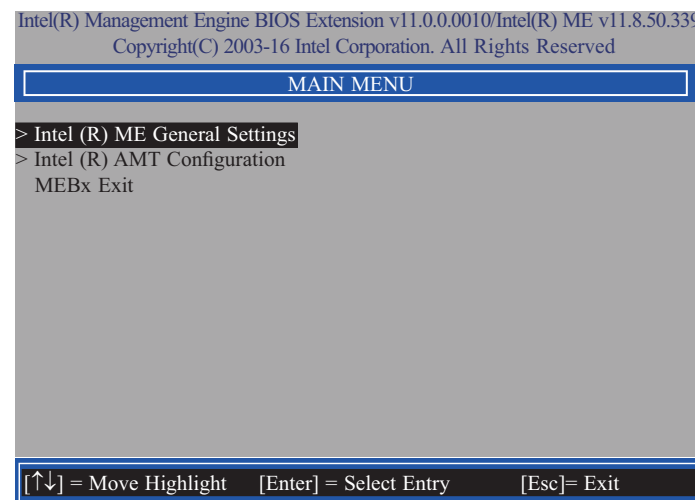

7. Select "Change Intel(R) ME Password" and then press "Enter".

You will be prompted for a password. The default password is "admin". Enter the default password in the space provided under "Intel(R) ME New Password" and then press "Enter".

- 8-32 characters
- Strong 7-bit ASCII characters excluding : , and " characters
- At least one digit character (0, 1, ...9)
- At least one 7-bit ASCII non alpha-numeric character, above 0x20, (e.g. !, \$, ;)
- Both lower case and upper case characters

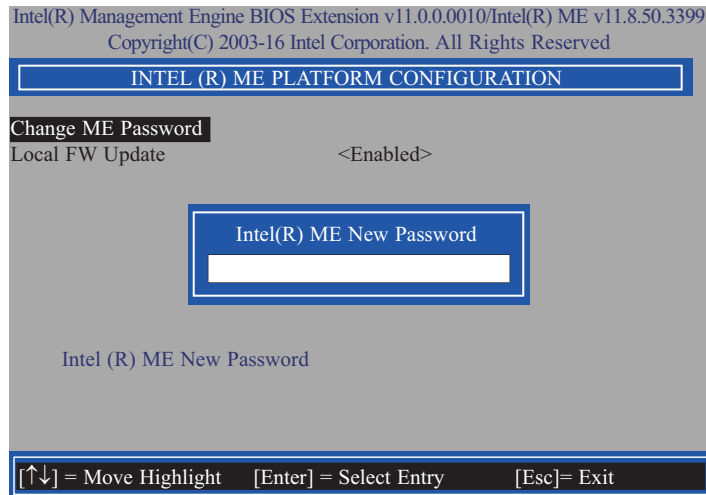

8. Select "Local FW Update" and then press "Enter". Select "Enabled" or "Disabled" or "Password Protected" and then press "Enter".

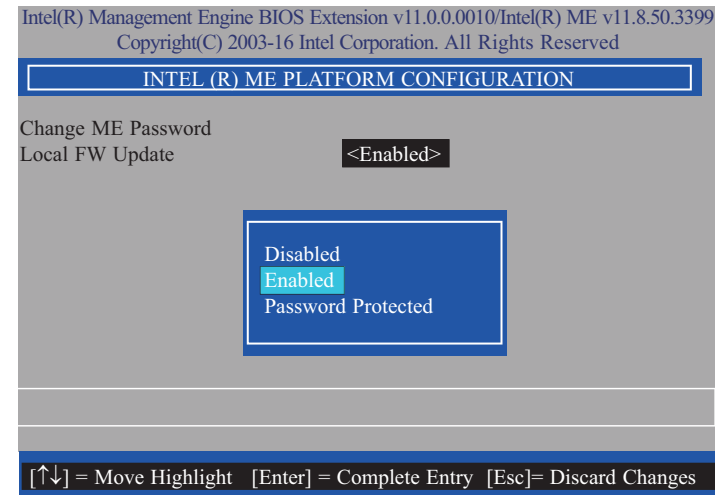

9. Select Previous Menu until you return to the "Main Menu". Select "Intel(R) AMT Configuration" and then press "Enter".

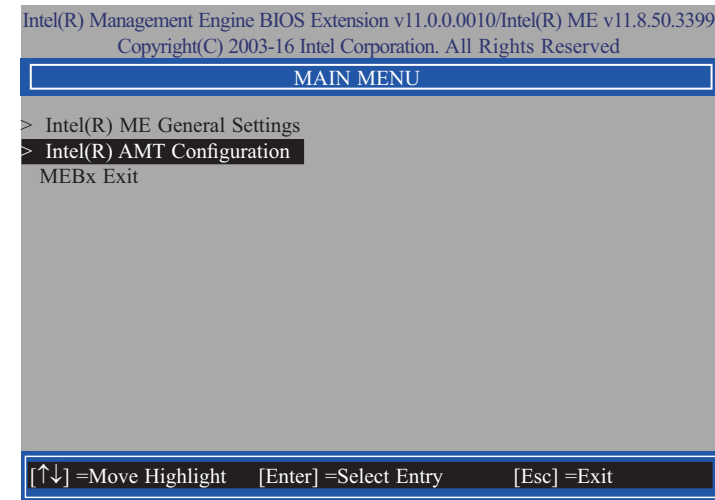

10. In the "Intel(R) AMT Configuration" menu, select "Manageability Feature Selection" and then press "Enter". Select "Enabled" or "Disabled" and then press "Enter".

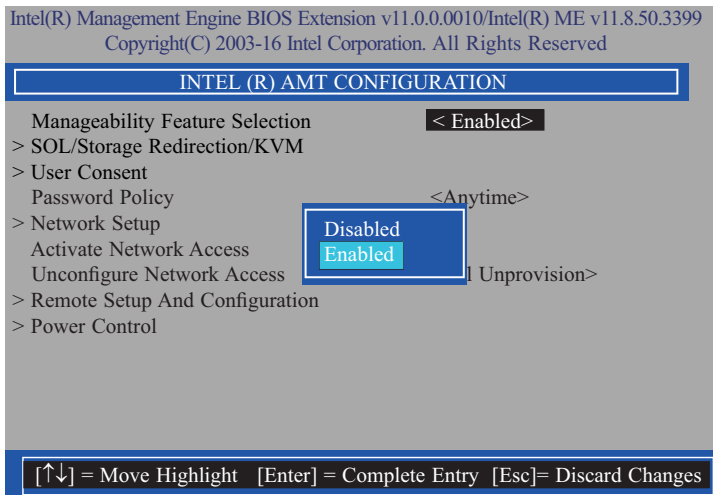

12. In the "SOL/Storage Redirection/KVM" menu, select "Username and Password" and then press "Enter". Select "Enabled" or "Disabled" and then press "Enter".

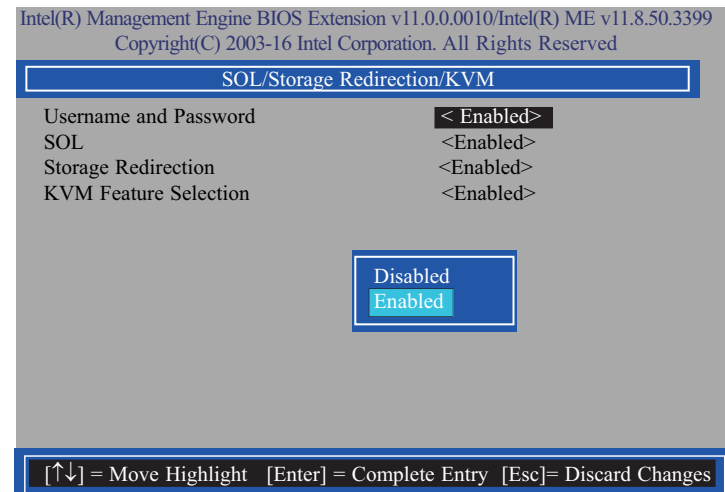

11. In the "Intel(R) AMT Configuration" menu, select "SOL/Storage Redirection/KVM" and then press "Enter".

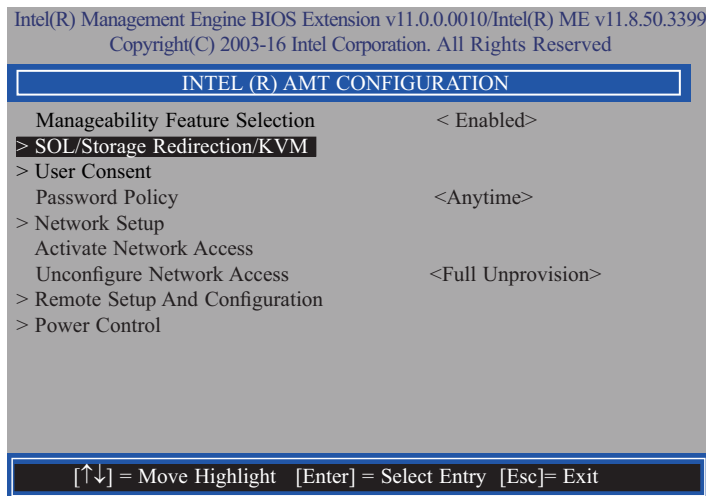

13. In the "SOL/Storage Redirection/KVM" menu, select "SOL" and then press "Enter". Select "Enabled" or "Disabled" and then press "Enter".

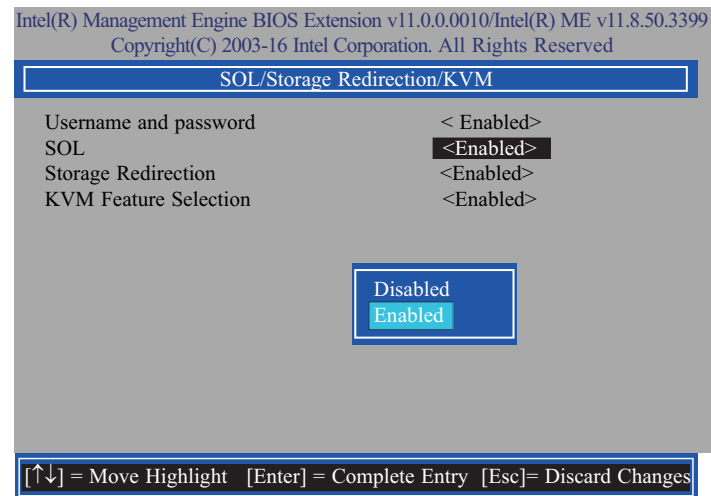

14. In the "SOL/Storage Redirection/KVM" menu, select "Storage Redirection" and then press "Enter". Select "Enabled" or "Disabled" and then press "Enter".

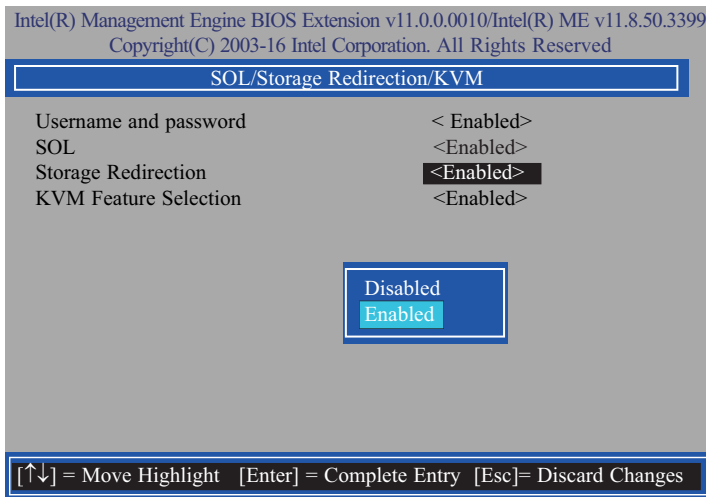

16. Select Previous Menu until you return to the "Intel(R) AMT Configuration" menu. Select "User Consent" and then press "Enter".

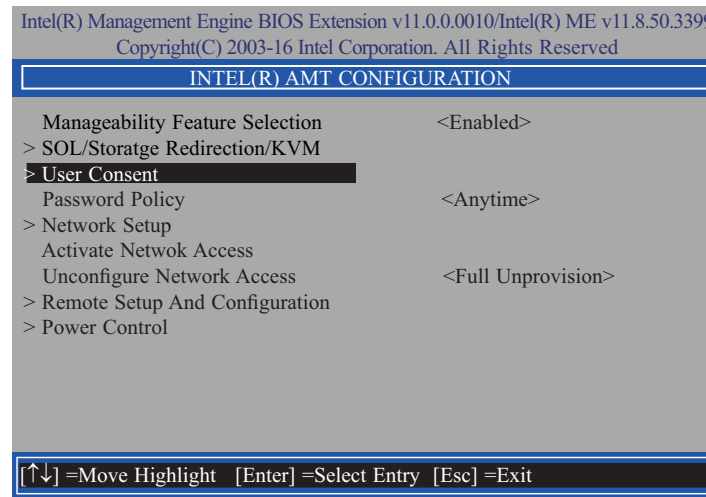

15. In the "SOL/Storage Redirection/KVM" menu, select "KVM Feature Selection" and then press "Enter". Select "Enabled" or "Disabled" and then press "Enter".

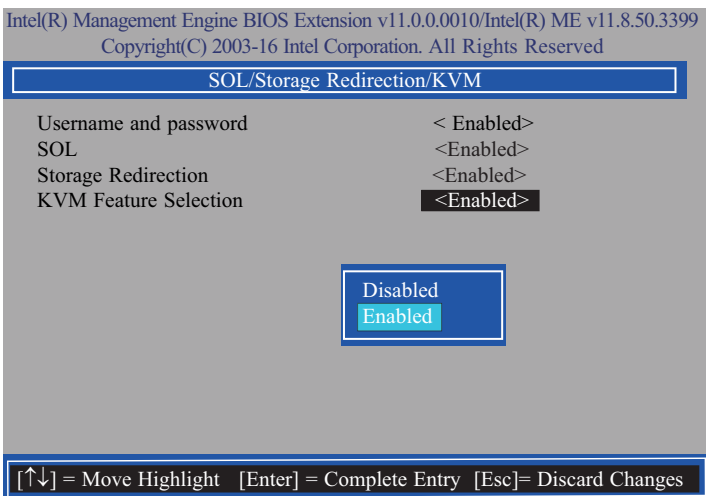

17. In the "User Consent" menu, select "User Opt-in" and then press "Enter". Select "None", "KVM" or "ALL" and then press "Enter".

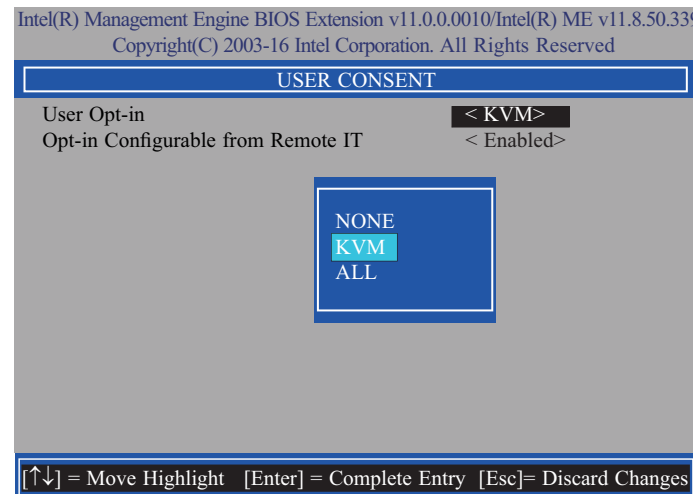

18. In the "User Consent" menu, select "Opt-in Configurable from Remote IT" and then press "Enter". Select "Enabled" or "Disabled" and then press "Enter".

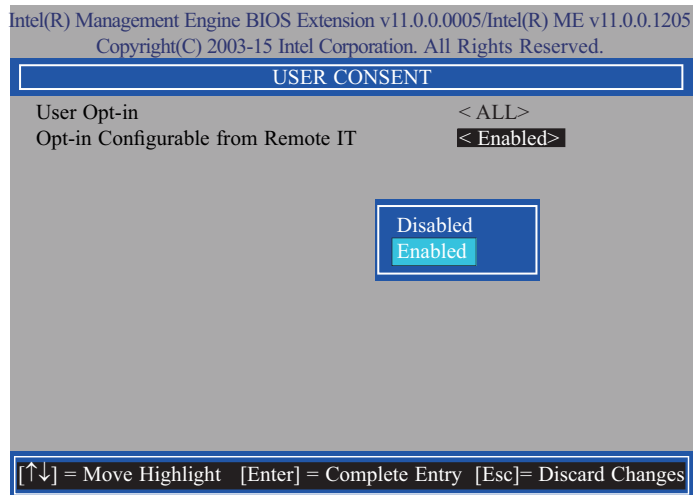

19. Select Previous Menu until you return to the "Intel(R) AMT Configuration" menu. Select "Password Policy" and then press "Enter". You may choose to use a password only during setup and configuration or to use a password anytime the system is being accessed.

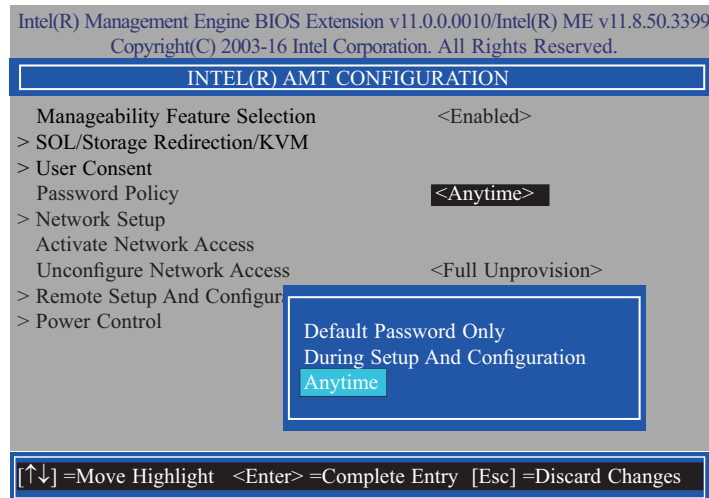

20. In the "Intel(R) AMT Configuration" menu, select "Network Setup" and then press "Enter".

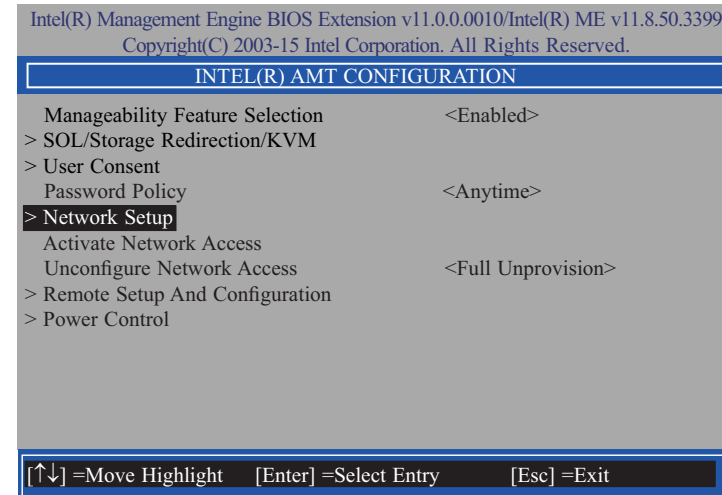

21. In the "Intel(R) ME Network Setup" menu, select "Intel(R) ME Network Name Settings" and then press "Enter".

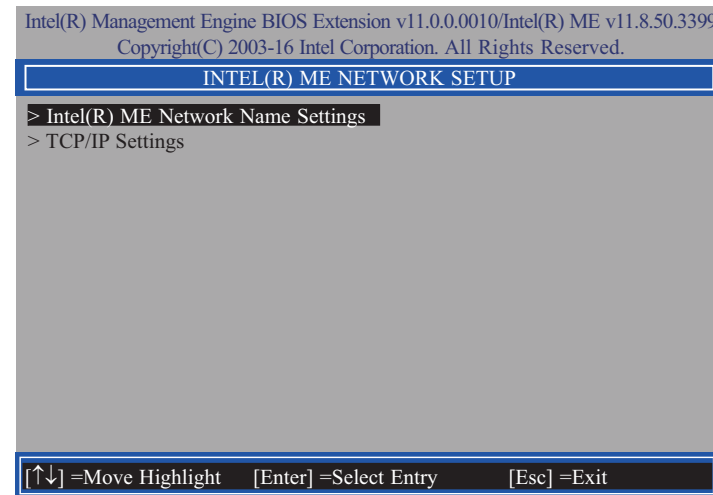

22. In the "Intel(R) ME Network Name Settings" menu, select "Host Name" and then press "Enter". Enter the computer's host name and then press "Enter".

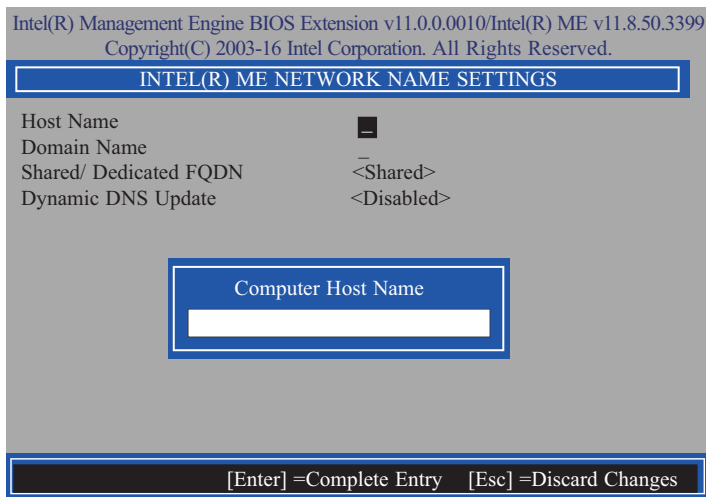

24. Select "Shared/Dedicated FQDN" and then press "Enter". Select "Shared" or "Dedicated" and then press "Enter".

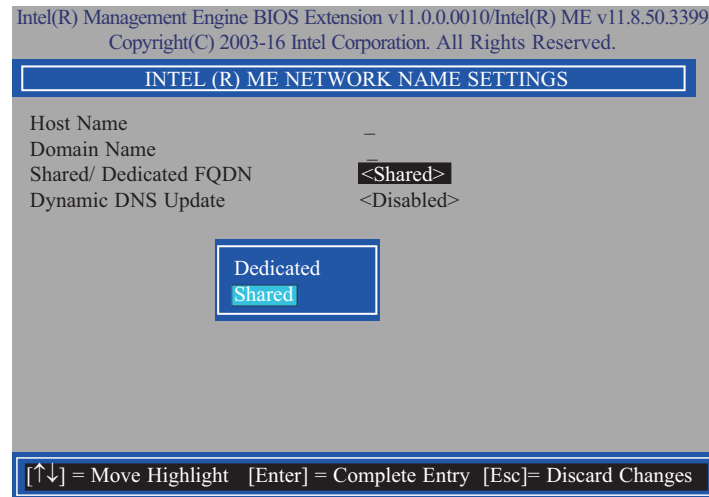

23. Select "Domain Name" and then press "Enter". Enter the computer's domain name and then press "Enter".

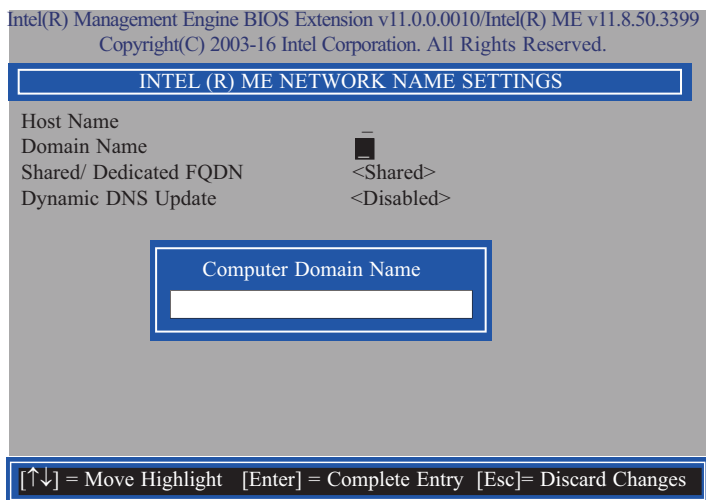

25. Select "Dynamic DNS Update" and then press "Enter". Select "Enabled" or "Disabled" and then press "Enter".

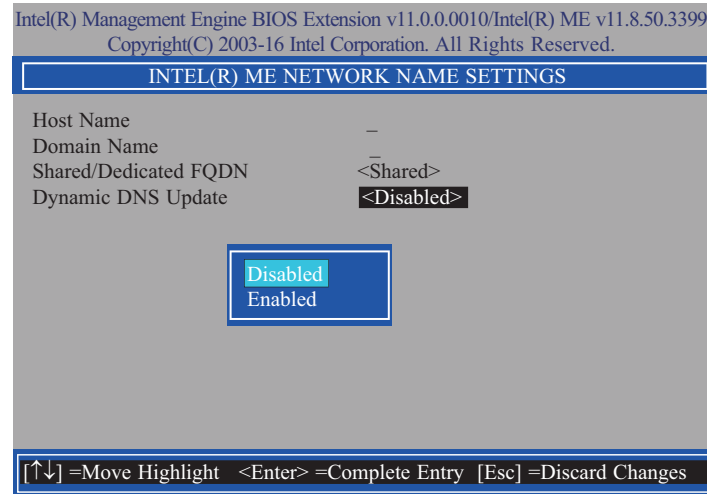

26. Select Previous Menu until you return to the "Intel(R) ME Network Setup" menu. Select "TCP/IP Settings" and then press "Enter".

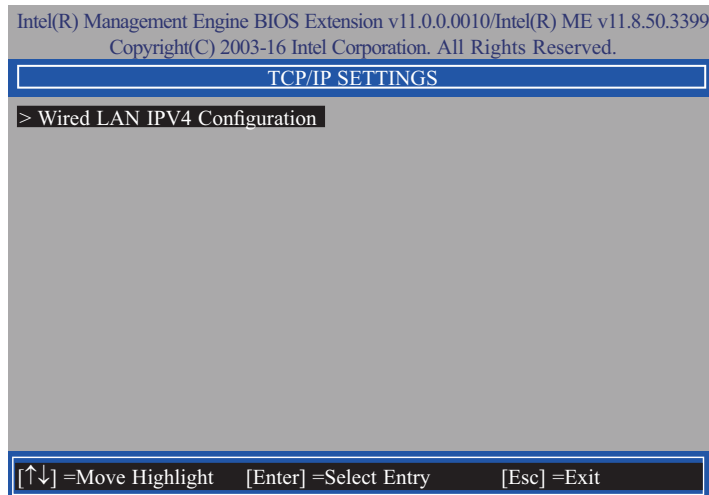

27. In the "TCP/IP Settings" menu, select "Wired LAN IPV4 Configuration" and then press "Enter".

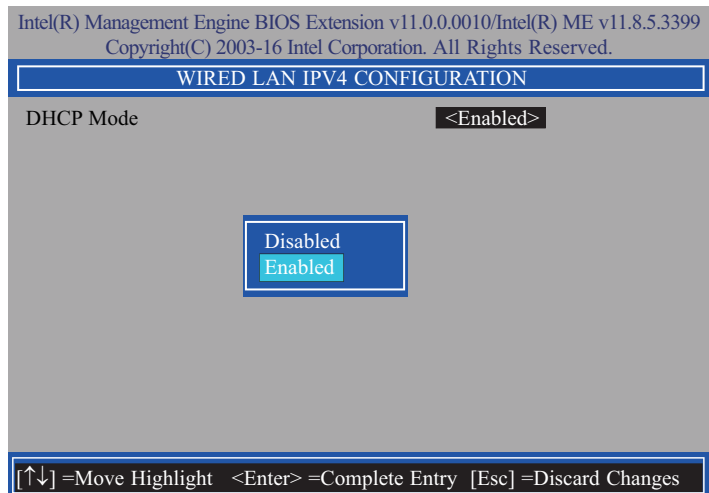

28. In the "Intel(R) AMT Configuration" menu, select "Activate Network Access" and then select "Yes/No" and press "Enter".

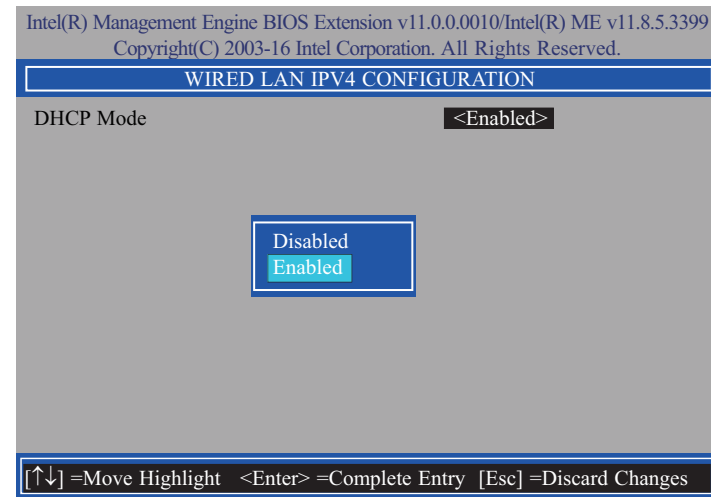

29. In the "Intel(R) AMT Configuration" menu, select "Unconfigure Network Access" and then press "Enter".

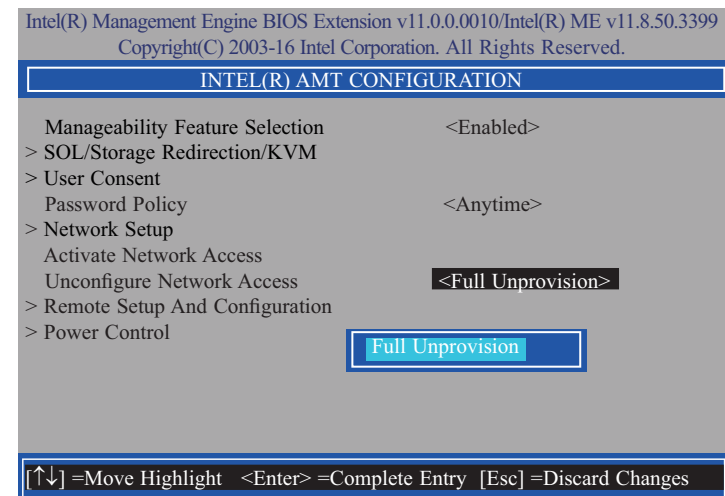

30. In the "Intel(R) AMT Configuration" menu, select "Remote Setup And Configuration" and then press "Enter".

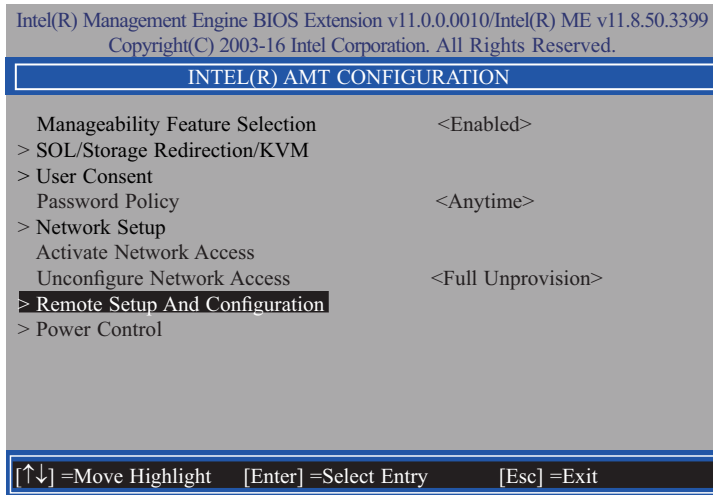

32. In the "Intel(R) Remote Setup And Configuration" menu, select "Provisioning Record" and then press "Enter".

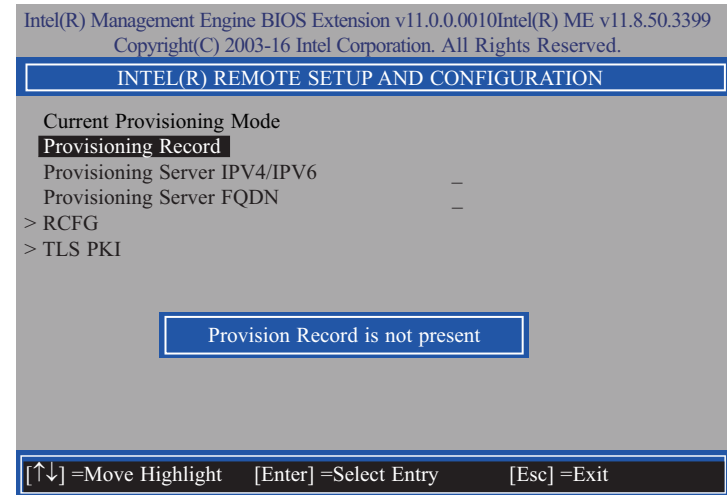

31. In the "Intel(R) Remote Setup And Configuration" menu, select "Current Provisioning Mode" and then press "Enter".

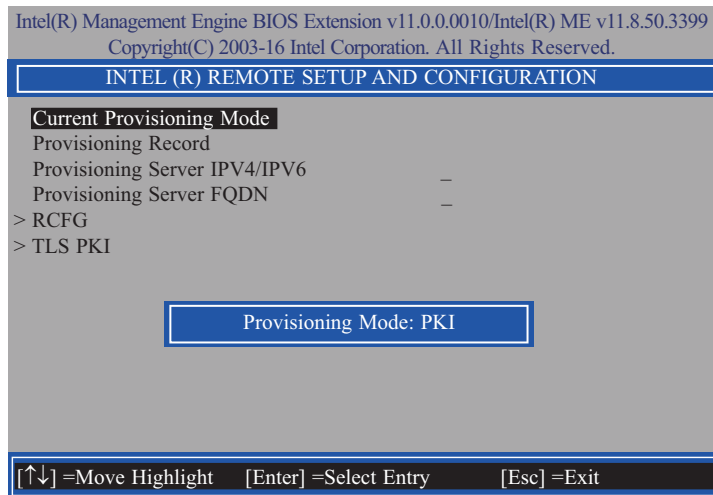

33. In the "Intel(R) Remote Setup And Configuration" menu, select "Provisioning server IPV4/ IPV6", enter "Provisioning server address" and then press "Enter".

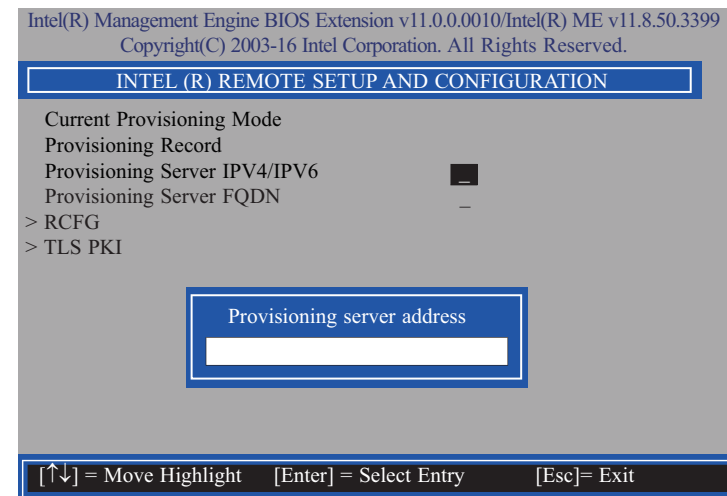

34. In the "Intel(R) Remote Setup And Configuration" menu, select "Provisioning server FQDN", enter the FQDN of Provisioning server, and then press "Enter".

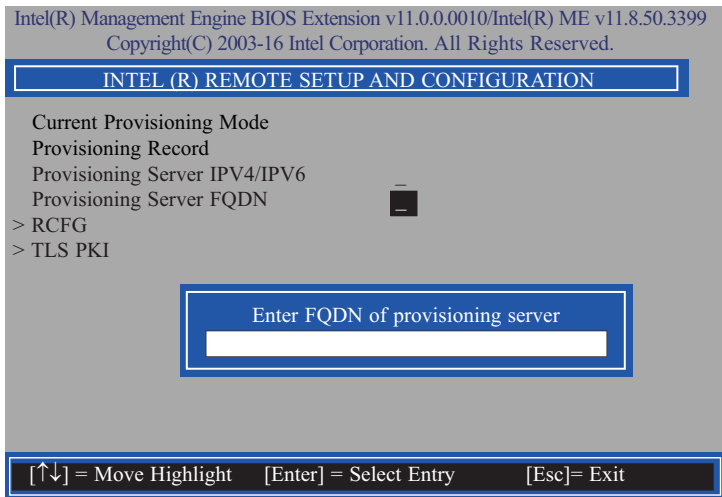

36. In the "Intel(R) Remote Setup And Configuration" menu, select "TLS PKI" and then press "Enter".

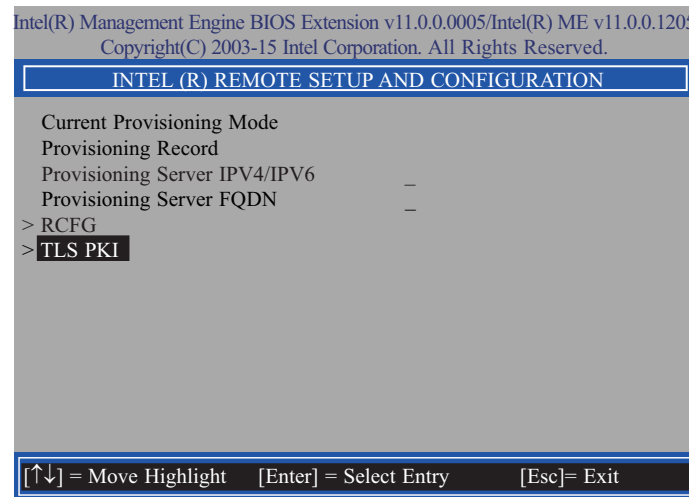

35. In the "Intel(R) Remote Setup And Configuration" menu, select "RCFG" and press "Enter", and then select "Start Configuration Y/N" and press "enter".

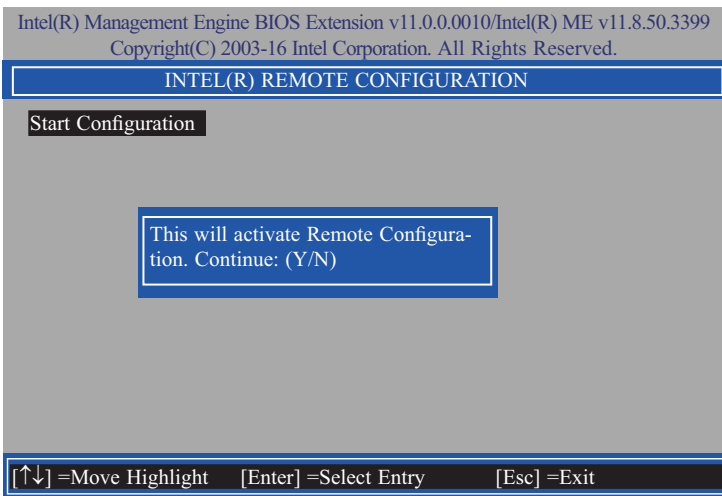

37. In the "Intel(R) Remote Configuration" menu, select "Remote Configuration**" and press "Enter", and then select "Enabled" or "Disabled" and press "Enter".

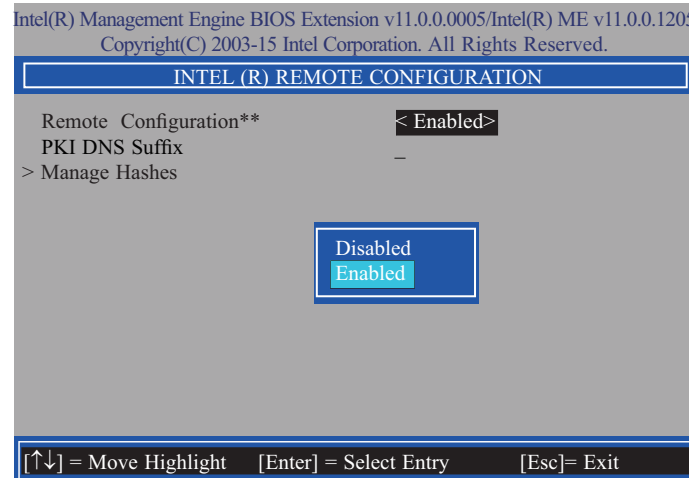

38. Select "PKI DNS Suffix", enter the "PKI DNS Suffix", and then press "Enter".

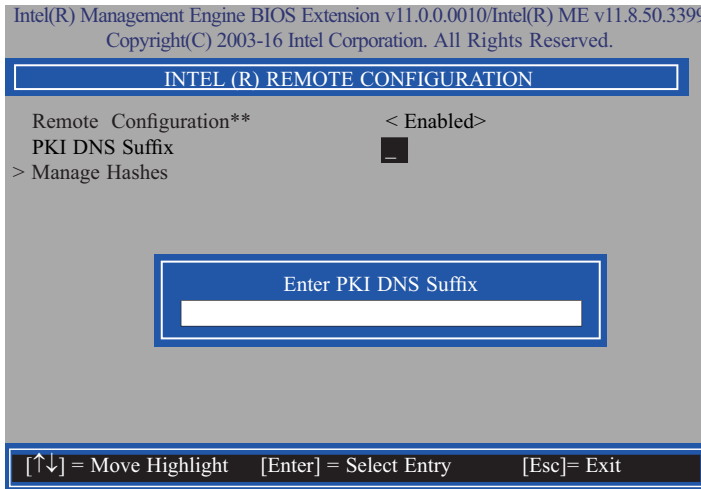

39. Select "Manage Hashes", and then press "Enter".

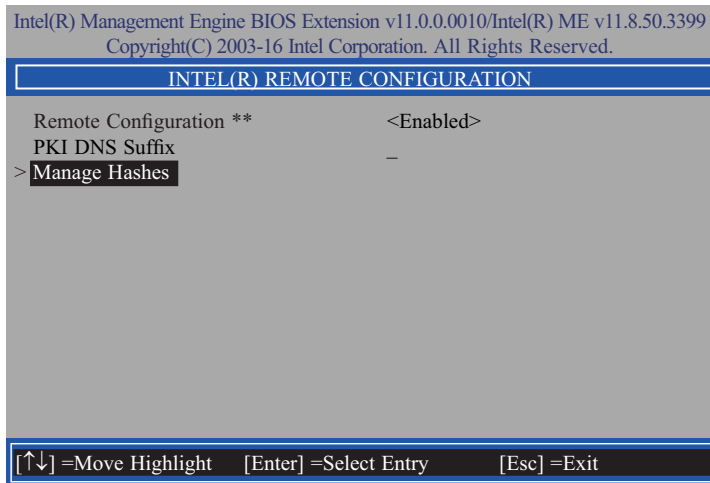

40. In the "Intel(R) Remote Configuration" menu, select the hash name then press Insert to enter custom hash certificate name, press Delete to delete a hash, press Enter to view hash information, or press + to activate or deactivate hash.

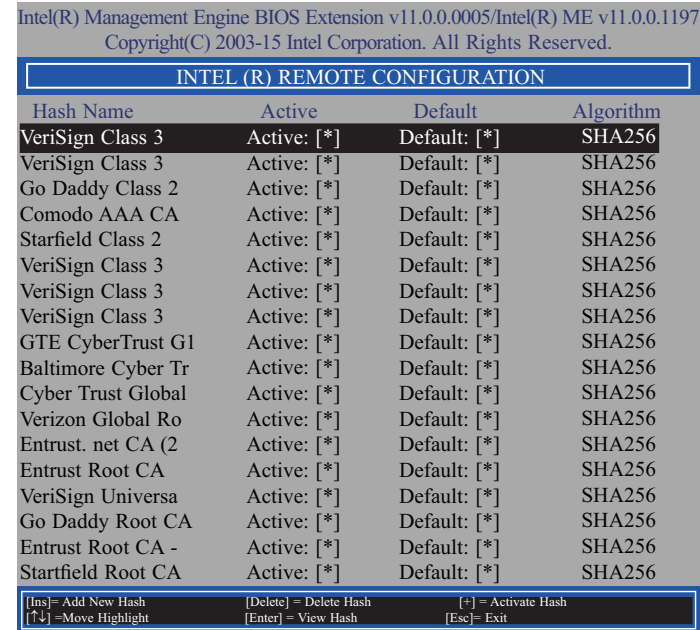

41. In the "Intel(R) AMT Configuration" menu, select "Power Control", and then press Enter.

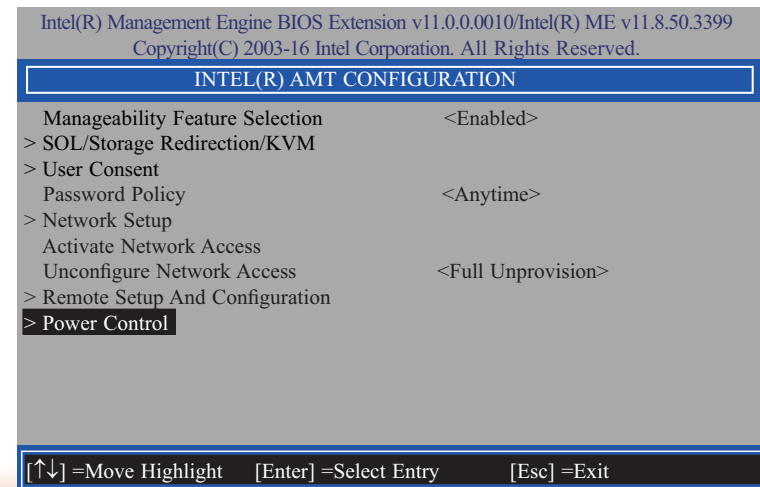

42. In the "Intel(R) AMT Power Control" menu, select "Intel(R) AMT ON in Host Sleep States" then press Enter. Select an option then press "Enter".

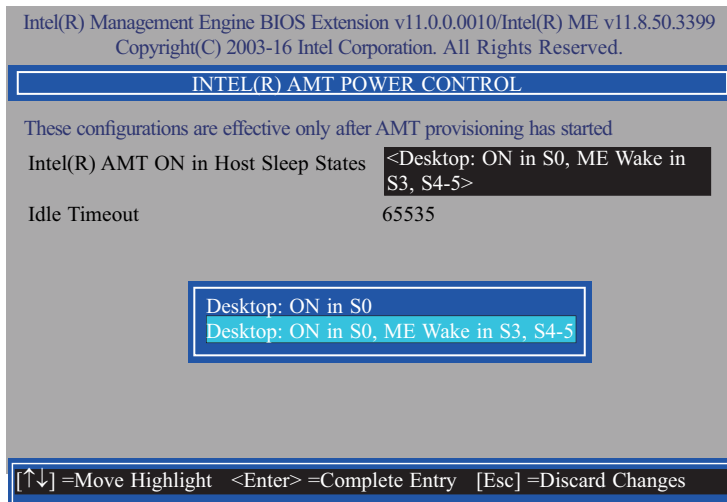

44. Press "Esc" until you return to the "Main Menu". Select "MEBx Exit" then press "Enter". Press "Y" then press "Enter".

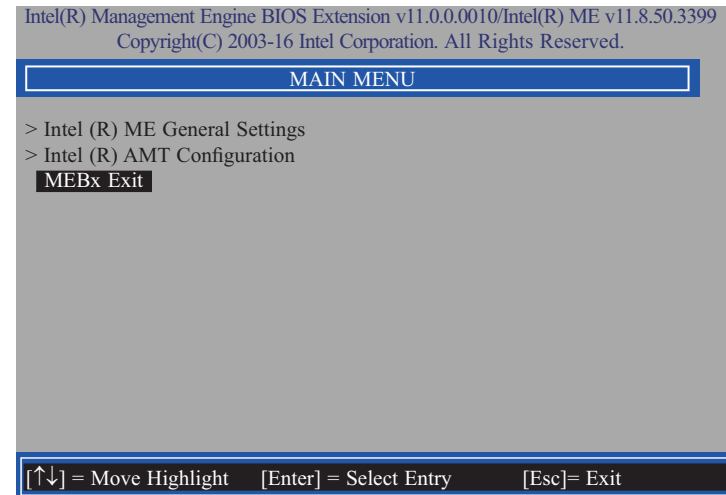

43. In the "Intel(R) AMT Power Control" menu, select "Idle Timeout" and then press "Enter". Enter the timeout value (1-65535).

